Remedial Design Work Plan

**701 Lawrence Street
Environmental Restoration Project**

City of Rome
Oneida County, New York

Prepared For

City of Rome
Department of Planning and Community Development
Rome City Hall
198 North Washington Street
Rome, New York 13440

August 2021
Revised September 2021

Barton & Loguidice

701 Lawrence Street
Environmental Restoration Project

City of Rome
Oneida County, New York

Remedial Design Work Plan

New York State Assistance Contract No. C303404
Site No. E633058

August 2021
Revised September 2021

Prepared For:

City of Rome
Department of Planning and Community Development
Rome City Hall
198 North Washington Street
Rome, New York 13440

Prepared By:

Barton & Loguidice, D.P.C.
443 Electronics Parkway
Liverpool, New York 13088

Certification Statement

I, the undersigned Engineer, certify that I am currently a NYS Registered Professional Engineer. This Remedial Design Work Plan was prepared in accordance with all applicable statutes and regulations, and in substantial conformance with the DER Technical Guidance for Site Investigation and Remediation (DER-10).



Scott D. Nostrand, P.E.
NYS P.E. No. 075454

September 22, 2021
Date



Table of Contents

<u>Section</u>	<u>Page No.</u>
EXECUTIVE SUMMARY	E-1
1.0 INTRODUCTION	1
1.1 Scope.....	1
1.2 Project Background.....	1
1.2.1 Site Location.....	1
1.2.2 Completed Interim Remedial Measures.....	2
1.2.2.1 Interim Remedial Measure No. 1.....	3
1.2.2.2 Interim Remedial Measures No. 2	3
1.2.2.3 Interim Remedial Measures No. 3	4
1.3 Record of Decision Summary	5
1.3.1 Remediation Action Objectives	6
1.3.2 Summary of Selected Remedy	6
1.3.2.1 Site Cover.....	6
1.3.2.2 Natural Attenuation	7
1.3.2.3 Institutional Controls.....	7
1.3.2.4 Site Management Plan	7
1.4 Report Organization.....	7
2.0 DESIGN SCOPE.....	8
2.1 Basis of Design.....	8
2.2 Green Remediation.....	8
2.3 Site Preparation.....	8
2.4 Site Grading and Drainage	10
2.5 Cover System	10
2.5.1 Site Cover Materials, Placement and Compaction.....	10
2.5.2 Topsoil and Seeding	11
2.6 Security, Control and Access	12
2.7 Health and Safety	12
2.7.1 Equipment and Personnel Decontamination Facilities.....	12
2.7.2 Community Air Monitoring	12
2.8 Storm Water Management.....	13
3.0 PERMITS AND OTHER AUTHORIZATIONS.....	14
4.0 SCHEDULE	15
5.0 POST CONSTRUCTION PLANS.....	16
5.1 Institutional Controls	16
5.2 Site Management Plan	16
5.3 Final Engineering Report	17
6.0 REFERENCES.....	18

Drawings

Drawing G001 Cover Sheet
Drawing G002 General Notes
Drawing C100 Existing Site Conditions Plan
Drawing C101 Erosion, Sediment and Stormwater Control Plan
Drawing C102 Subgrade Grading Plan
Drawing C103 Final Grading and Soil Cover Plan
Drawing C501 Sections
Drawing C502 Cover System Details
Drawing C503 Erosion and Sediment Control Details

Appendices

Appendix A Record of Decision

LIST OF ACRONYMS AND ABBREVIATIONS

amsl	above mean sea level
bgs	below ground surface
CAMP	Community Air Monitoring Plan
ELAP	Environmental Laboratory Accreditation Program
ft	foot (feet)
HASP	Health and Safety Plan
IC	Institutional Control
IRM	Interim Remedial Measure
mg/kg	milligrams per kilogram
NYCRR	New York Code of Rules and Regulations
NYSDEC	New York State Department of Environmental Conservation
NYSDOH	New York State Department of Health
NYSDOT	New York State Department of Transportation
PAHs	polycyclic aromatic hydrocarbons
PCB	polychlorinated biphenyl
PDI	Pre-Design Investigation
RDWP	Remedial Design Work Plan
RI	Remedial Investigation
yd ³	cubic yards

EXECUTIVE SUMMARY

The 701 Lawrence Street (Site) is located at the intersection of Luquer and Lawrence Streets in the City of Rome, Oneida County, New York. The Site is identified by the NYSDEC as Operable Unit Number 01 and is situated on the north side of the New York State Barge Canal, was formerly used for petroleum bulk storage circa 1936 and lasting until May 1990. Based on past use, the site was home to a variety of environmental concerns. Three (3) interim remedial measures were conducted at the site between 2007 and 2009 resulting in the removal of asbestos, single-story building demolition, drums and other containers of waste, aboveground and underground bulk storage tanks, miscellaneous debris, and contaminated soils. A detailed account of the IRMs performed at the site were documented in the 2012 Interim Remedial Measures Construction Completion Report prepared by Barton & Loguidice, D.P.C. (B&L). Please note that the site located on the south side of the New York State Barge Canal, at the intersection of Lawrence and Martin Street (Operable Unit #2) is not the focus of this environmental restoration project. Similar to OU-1, the OU-2 site was previously associated with bulk fuel storage and distribution operations which resulted in subsurface petroleum impacts to the City-owned property.

The performance of a Remedial Investigation (RI) by B&L in 2014 identified metals and tentatively identified compounds (TICs) for volatile organic compounds and semi-volatile organic compounds (VOCs & SVOCs) in surface soil, subsurface soil and groundwater. Further review of the reported TICs indicated that the TICs primarily consisted of hydrocarbons and polycyclic hydrocarbons (PAHs), both groups of which are associated with petroleum products. Based on the site's history as a bulk petroleum storage area, TICs were related to weathered subsurface petroleum contamination.

Subsequent to the performance of an RI, B&L prepared a Remedial Alternative Report (RAR) in 2015, which evaluated the following:

- Alternative 1 - No Further Action;
- Alternative 2 - Soil Cover with Institutional Controls; and
- Alternative 3 - Soil Excavation and Off-Site Disposal

As recommended in the RAR and identified in the Record of Decision (February 2017), Alternative 2 was selected as the site remedy, as this alternative would achieve the remediation goals for the site by covering any remaining contaminated soil on-site. The Site will be restored with a minimum two foot thick soil cover meeting NYSDEC restricted-residential standards as follows: an eighteen-inch cover of clean soil and six inches of topsoil. A demarcation layer will be installed above remaining site soils delineating the surface below which pre-remediation site soils may be present. The final steps of the remedy will require the use of an institutional control in the form of an environmental easement for the site as well as the development of a Site Management Plan (SMP), including a groundwater monitoring plan for natural attenuation.

1.0 INTRODUCTION

1.1 Scope

The following Remedial Design Work Plan (RDWP) has been prepared in accordance with the provisions outlined in the NYSDEC February 2017 Record of Decision (ROD) for the remediation of petroleum contaminated soil encountered at the portion of the 701 Lawrence Street site designated by the Department as OU-1 (the Site). Specifically, OU-1 is located at the intersection of Luquer and Lawrence Streets in the City of Rome, Oneida County, New York (Figure 1). The portion of the 701 Lawrence Street site that is located at the intersection of Lawrence and Martin Streets on the south side of the New York State Barge Canal has been designated by the Department as Operable Unit #2 (OU-2).

A remedial investigation (RI) was completed by B&L in June 2014 (B&L 2014) and Remedial Alternatives (RAs) were developed and evaluated against the remedy selection criteria presented in 6 NYCRR Part 375-1.8(f) and presented in the Remedial Alternatives Report (RAR) prepared by B&L dated May 2015 (B&L 2015). As defined in the RAR and accepted by the NYSDEC in the February 2017 Record of Decision for the site (Appendix A), the selected remedial alternative consists of Placement and Maintenance of a Soil Cover for Exposure Reduction and Development of Institutional Controls. The detailed scope of work is presented in Section 5 of this RDWP.

This RDWP has been prepared in accordance with the provisions of NYSDEC DER-10 (Technical Guidance for Site Investigation and Remediation). The site is a part of the Environmental Restoration Project funded in part by the 1996 Clean Water/Clean Air Environmental Bond Act to remediate petroleum impacted soil that exists across the site in order to meet the NYSDEC Part 375 Soil Cleanup Objectives (SCOs) for Restricted-Residential Use.

1.2 Project Background

The site is located on the north side of the New York State Barge Canal and was formerly used for petroleum bulk storage circa 1936 and lasting until May 1990. The site previously contained a single, one-story, open-sided building that was located in the northwestern portion of the property, along with miscellaneous debris and a large aboveground storage tank (AST) throughout the remainder of the property. Up until August 2009, the site contained a single, one-story, open-sided 7,450 square foot building with a metal roof and metal siding that was located in the northwestern portion of the property, along with significant amounts of miscellaneous debris and a large aboveground storage tank (AST) throughout the remainder of the property, which has all been removed. The site is currently unoccupied and devoid of improvements.

1.2.1 Site Location

The Site is located in the City of Rome, Oneida County, New York (see Figure G001), and is designated on the City of Rome tax parcel map as parcel number 242.082-0001-031. The 1.85- acre site is located at the intersection of Lawrence Street and Martin Street.

The subject parcel is bordered to the north by Luquer Street, with a vacant lot and an automotive repair facility located on the opposite side of the street. The eastern portion of the site is bordered by remnants of Canal Street and railroad tracks, while the site is bordered to the south by the Canalway Trail which consists of a paved, multi-use recreational pathway that extends along the shoreline of the New York Barge Canal. The western side is bound by Lawrence Street, which dead ends before the Erie Canal. (The bridge that historically carried Lawrence Street across the canal has been removed; Lawrence Street continues on the south side of the Erie Canal).

1.2.2 Completed Interim Remedial Measures

Prior to the implementation of Interim Remedial Measures (IRMs), the site was home to a variety of miscellaneous debris, drums, aboveground storage tanks, and underground storage tanks, with related environmental concerns as described below. Prior to the IRMs the Site included one structure in the northwestern corner of the property. The building (or portions thereof) is believed to be more than 75 years old. Within the building structure there was observed several 55-gallon drums, vehicle maintenance materials (i.e., oil filters, spray cans, 5-gallon oil/ lubricant containers), window air conditioner units, paint cans, refrigerant cylinders, refrigerators, thermostats, unknown aqueous products located in 5 gallon buckets, three (3) 275-gallon above ground storage tanks (ASTs), a boiler, a hot water heater, and fluorescent bulbs and ballasts. Portions of the building's structural integrity were a health and safety concern, and its presence was detrimental to the proper and thorough characterization of subsurface conditions underneath the structure.

Also located on the site was a 4,000-gallon AST that was observed to be a former mobile fueling tank, an empty portable rectangular AST (~ 30-gallon), an inoperable vehicular truck and approximately 125 used tires. A concrete block wall with the estimated dimensions of 30 feet long by 6 feet high was located in the southeastern portion of the site. The concrete wall, which is oriented east-west and parallel to the New York State Barge Canal, likely represents remnants of a portion of the containment dike for the major oil storage tanks.

In addition to the above, two (2) underground storage tanks (USTs) were believed to exist on site. One of the USTs was believed to be a 1,000-gallon fuel tank associated with a former gasoline dispenser and the other UST was of unknown size and service. During a site visit to the subject parcel on August 17, 2007, Mr. Phil Waite of the NYSDEC Region 6 Office verbally recommended that as an IRM, the building be demolished along with the removal of the on-site debris described above.

Three (3) interim remedial measures were conducted at the Site. The purpose of the IRMs performed at the Site was to eliminate remaining sources of contamination, thereby reducing the risk of harm to human health, ecological resources, and the environment. The following IRMs were established for the site:

- IRM-1 – asbestos abatement;
- IRM-2 – removal of waste, aboveground storage tanks (ASTs), drums, tires, and miscellaneous container; and,
- IRM-3 – removal of USTs and former stormwater oil/water separator unit. Investigation and removal of underground petroleum pipelines related to the former major oil storage facility.

All IRM and UST closure activities were performed in accordance with EPA, NYSDEC, and petroleum industry guidelines. Prior to IRM-3, the City of Rome undertook the demolition of the site structure.

1.2.2.1 Interim Remedial Measure No. 1

A pre-demolition asbestos and lead-based paint survey was completed by B&L on August 30, 2007. Several materials within the former garage were identified as probably asbestos containing materials (ACM) and were required to be removed by a licensed contractor. The survey also identified the existence of lead-based paint both on the interior and exterior of the structure. All interior paints which tested positive for the presence of lead exhibited low-level detections (less than 0.5%) of lead. The exterior window sills, exterior window panels and exterior overhead doors contained higher levels (approximately 7%) of lead.

Midlantic Environmental (License No. 29380) was selected as the low bidder for the abatement work and was responsible for the removal and disposal of the probably ACMs in January and February of 2009. The materials removed included floor tile, window glazing, wall mastic, transite pipe, transite panels, and roof lashing. During abatement, additional ACM was discovered in relation to the boiler in the previously flooded basement area of the building. Examination during construction indicated that the identified lead-based paint was sufficiently adhered and items containing lead-based paint were removed upon demolition of the structure subsequent to IRM No. 2 by the City of Rome.

1.2.2.2 Interim Remedial Measures No. 2

B&L completed a chemical inventory of the site on August 19, 2008. Drums and containers of petroleum products and other miscellaneous wastes were characterized at the site. OP-TECH was selected to perform the work and mobilized to the site on June 3, 2009 and completed the work by July 14, 2009. Materials removed included aerosol cans, oil-based paint, combustible liquid, mercury containing thermostats and equipment, window air conditioner, non-PCB light ballasts, fluorescent light bulbs, used tires, petroleum contaminated fluids and solids and above ground storage tanks.

Following the removal of drums and waste, the City of Rome Department of Public Works demolished the site structure, taking place from June through August 2009. Demolition materials included C&D debris, concrete block and slab material, and scrap metal.

1.2.2.3 Interim Remedial Measures No. 3

Following the removal of waste materials by OP-TECH and the demolition of the structure, IRM No. 3 was prepared for the removal of USTs, investigations of unknown structures, and piping. The following operations were completed by a remedial contractor:

- Installation of fencing to secure the Site;
- Excavation of exploratory test pits throughout the Site, including five (5) test pits on the adjacent NYS Canal Corporation property;
- Removal and closure of three (3) USTs, two (2) of which were located on-site. The third, located on NYS Canal Corporation property, found to be associated with an off-site stormwater treatment system;
- Removal and closure of a system on NYS Canal Corporation property apparently used to separate oil from stormwater draining from the Site; and
- Removal of underground petroleum transmission pipelines, portions of which were located on NYS Canal Corporation property.

During the performance of IRM No. 3, approximately 730 tons of petroleum contaminated soil was excavated and removed from the Site (150 of which were from the NYS Canal Corporation property). Approximately 7,850 gallons of petroleum contaminated fluids were also removed from the site. Of the 7,850 gallons removed from the site, 5,000 gallons of this were derived from the stormwater treatment system and UST located on NYS Canal Corporation property.

Confirmation soil samples were collected by a B&L representative from each of the aforementioned UST excavations and the former stormwater treatment system unit, as previously described in the respective sections of this report. Specifically, a total of nine (9) confirmation soil samples were collected. Two (2) of the confirmation soil samples were located onsite and seven (7) were located offsite. The nine (9) confirmation soil samples were submitted to TestAmerica Laboratories for the analysis of VOCs (EPA Method 8260) plus MTBE, SVOCs (EPA Method 8270), Metals (EPA Method 6010B, where applicable), and PCBs (EPA Method 8080).

1.3 Record of Decision Summary

The ROD is attached as Appendix A. The ROD's requirements for the remediation are summarized below.

1.3.1 Remediation Action Objectives

The remedial action objectives (RAOs) for this site are:

Groundwater

RAOs for Public Health Protection

- Prevent ingestion of groundwater with contaminant levels exceeding drinking water standards.
- Prevent contact with, or inhalation of volatiles, from contaminated groundwater.

RAOs for Environmental Protection

- Prevent the discharge of contaminants to surface water.

Soil

RAOs for Public Health Protection

- Prevent ingestion/direct contact with contaminated soil.
- Prevent inhalation of or exposure from contaminants volatilizing from contaminants in soil.

RAOs for Environmental Protection

- Prevent migration of contaminants that would result in groundwater or surface water contamination.

Soil Vapor

RAOs for Public Health Protection

- Mitigate impacts to public health resulting from existing, or the potential for, soil vapor intrusion into buildings at a site.

1.3.2 Summary of Selected Remedy

The selected remedy comprises four components

1.3.2.1 Site Cover

A site cover will be installed over the site to prevent exposure to soils exceeding Restricted Residential SCOs. The site cover may consist of two feet of soil meeting the Restricted Residential SCOs presented in Part 375-6.7(d) or a paved surface

1.3.2.2 Natural Attenuation

Groundwater will be monitored for site related contamination and for NA indicators which will provide an understanding of the (biological activity) breaking down the contamination. Reports of the attenuation will be provided periodically and active remediation will be proposed if it appears that natural processes alone will not address the contamination.

1.3.2.3 Institutional Controls

An environmental easement will be placed on the property to restrict future use to restricted-residential, commercial, and industrial uses as defined by Part 375-1.8(g). Additionally, the environmental easement will restrict the use of groundwater as a source of potable or process water

1.3.2.4 Site Management Plan

A Site Management Plan (SMP) will be developed in accordance with the requirements of Section 6.2 of DER-10.

1.4 Report Organization

This report has been organized using the following sections:

- Section 1 – Introduction
- Section 2 – Design Scope
- Section 3 – Permits and Other Authorizations
- Section 4 – Schedule
- Section 5 – Post Construction Plans
- Section 6 – References

2.0 DESIGN SCOPE

A general description of the planned remedial construction measures for the Site, consistent with the ROD, is presented in this section. Details of the planned construction are contained in the plans and specifications to be developed under separate cover.

2.1 Basis of Design

The remedial design will primarily address the placement of the required soil cover. Other elements of the Remedial Action, including the institutional control in the form of an environmental easement and associated site management plan will be performed separately from the remedial construction.

2.2 Green Remediation

The design will implement, to the greatest extent practicable, green remediation measures during the completion of all remedial activities on-site, in order to reduce the overall environmental footprint associated with the implementation of the remedy. Typical green remediation measures that the remedial action may implement, include, but are not limited to, the following:

- Minimize habitat disturbance and create or enhance habitat or usable land;
- Prevent unintended soil compaction;
- Minimize waste or implement beneficial use of materials that would otherwise be considered a waste;
- Minimize equipment and truck idling and use sustainably produced biofuels to reduce discharges of pollutants and greenhouse gases to the atmosphere;
- Utilize clean diesel (new or retrofitted) equipment to reduce emissions to the atmosphere;
- Minimize use of heavy equipment to save energy and reduce emissions;
- Purchase of renewable energy credits to offset temporary electric supply;
- Use of recycled and/or repurposed items within the job trailer; and
- Establish ground cover within areas restored and backfilled, as soon as possible, to minimize off-site erosion

2.3 Site Preparation

Site access will be from Canal Street through a constructed access road and ditch crossing, to be installed as part of this remedial project

Site preparation will involve clearing, grubbing and access improvements required for the soil cover work. Storm water management and erosion and sediment control practices will be

employed during all clearing and earthwork activities as shown on Drawing C101. Erosion and sediment controls will be established in the plans and specifications. At a minimum, control elements such as silt fences or wattles will be placed around all soil cover areas and construction access routes.

Monitoring wells located within the identified soil cover area, shown on Drawing C101, will require decommissioning in accordance with CP-43 "Commissioner Policy on Groundwater Monitoring Well Decommissioning". These include MW-4, MW-5, and MW-6. Field verification of the well depths will be verified. Monitoring wells to remain will include MW-1, MW-2, MW - 3, MW-7, and MW-9 for future site monitoring.

To facilitate heavy equipment access to the site, an access drive will be constructed across from Canal Street. In addition to the access drive, clearing will be performed in and around the area of the soil cover area to allow equipment access. Trees, shrubs and brush within the clearing limits will be removed to facilitate construction and post-closure maintenance work. Large trees and stumps will be removed from the Site. The existing asphalt pavement ("broken macadam") onsite will be perforated via a drill auger or other approved method to promote drainage through the impervious cover from the overlying soil cap.

Following mobilization to the site, the remedial contractor will be required to perform several activities, prior to initiating remedial activities. This will include, but not be limited to, the following:

- Coordination with the City of Rome and adjacent property owners;
- Locating and identifying underground utilities in coordination with the City of Rome and in accordance with local and state requirements;
- Clearing and grubbing of vegetation, brush and trees as necessary to facilitate access to all areas of the site;
- Installation of construction and access roads;
- Installation of temporary construction fence around all work areas;
- Installation of temporary utilities and controls;
- Consolidation and off-site disposal of any debris identified on-site;
- Preparation of required environmental submittals such as CAMP, Contractors HASP, Field Sampling and Waste Characterization, etc.; and
- Completion of a site survey to supplement the existing site survey, as necessary, and to mark out the extent of area to be covered.

2.4 Site Grading and Drainage

To minimize construction costs, a goal of the design is to minimize the amount of fill required to provide the cover system. The surface elevations of the cover system have been designed to allow for storm water drainage off the cover, with no low spots for water to collect. To minimize the amount of imported soil to achieve this goal, the contractor will be required to grade the current site to generate a soil surface that is roughly two feet below the elevation of the proposal final cover elevation. Currently, a soil stockpile exists at the southern portion of the site along with grade depressions that retain storm water with no drainage. The stockpile will be excavated along with other areas of the site and this material placed and graded in low-lying areas as fill. Generally, the site boundary will slope from the northeast to the southwest where an existing 18" culvert is located to the south of the pavement on Lawrence Street. This culvert drains the site storm water across the bike path and into the canal. The balance of cut and fill (approximately 450 cubic yards) from the site will promote drainage to this area. This will also allow for the two-foot cover to be placed uniformly across the site. The subgrade grading plan is shown on Drawing C102.

Two-feet of cover material cannot be placed uniformly to the extents of the site boundary in all locations around the perimeter of the site. Generally, the site boundary on the south and east will be excavated two-feet vertically to account for the two-foot cover material. This will provide the two-foot cover required and to match grade outside of the site boundary. The cover will be placed in the same manner on the eastern portion of the site up to the macadam driveway where the soil cover will transition to the existing elevation of the driveway. The north side of the site will transition the cover to the existing berm adjacent to the drainage ditch. Cross sections of the site grading and cover material is shown on Drawing C501.

2.5 Cover System

The final cover system will be constructed so that it functions with minimum maintenance, promotes drainage, and minimizes erosion. Although the ROD allows for use of pavement as a cover material, the design of the cover system calls for providing a minimum 18-inch thick soil layer and 6 inches of topsoil meeting the SCOs for cover material as set forth in 6 NYCRR Part 375-6.7(d) for restricted-residential use. A demarcation layer material will also be installed, prior to placement of the soil cover at the interface between the unexcavated soil and the imported backfill, in order to provide a physical boundary between the subsurface fill material and the overlying clean backfill material.

2.5.1 Site Cover Materials, Placement and Compaction

Clean fill will be comprised of natural soil material originating from borrow source locations having no evidence of disposal or releases of hazardous, toxic, or radioactive substances, or petroleum products. The clean fill would be segregated at a source/facility for verification sampling. Representative samples will be collected at a frequency consistent with NYSDEC DER-10 Table 5.4(e)10 and analyzed at a NYSDOH certified Environmental Laboratory Accreditation Program (ELAP) approved laboratory

in accordance with the listing in 6 NYCRR Part 375 Table 375-6.8 (b) for restricted-residential use. The remedial contractor will be responsible for collecting soil samples in accordance with the frequency specified in NYSDEC DER-10. Acceptable backfill material shall meet these required SCOs. Certification and chemical testing requirements for soil borrow materials will be developed in the contract specifications. The clean fill will contain no sod, vegetative matter, rubbish or debris. Proposed source(s) for other imported fill materials will be approved by the Engineer prior to delivery to the Site.

Additional details regarding backfill requirements will be included in the plans and specifications for the remedial design. The Certificate of Clean Fill will be submitted with the name of the supplier, the source of fill, and the history of the location where the fill was obtained for approval by the Engineer prior to use of the fill. Upon receipt, the Engineer will review the information provided regarding the backfill and shall determine the acceptability of the material and its source. Copies of the Certificates of Clean Fill will be submitted in the Final Engineering Report.

Cover soil will be placed and compacted to provide a minimum thickness of 18 inches across the final surface. Cover soil will be placed in 6-inch thick lifts, compacted wet of optimum moisture content to achieve a minimum of 90% of the modified proctor maximum density as determined by the Modified Proctor Compaction Test (ASTM D-1557-78).

2.5.2 Topsoil and Seeding

The topsoil layer is the uppermost component of the cover system. Its functions are to protect the underlying layer from mechanical damage, and (in conjunction with a vegetative cover) to protect against erosion. Topsoil used for final soil cover will be a natural loam surface soil with sufficient organic material and nutrient to establish and sustain vigorous vegetative growth, and will be free of clods of hard earth, plants or roots, sticks or other extraneous material.

Topsoil will be comprised of natural soil material originating from borrow source locations having no evidence of disposal or releases of hazardous, toxic, or radioactive substances, or petroleum products. Certification and chemical testing requirements for topsoil borrow materials will be developed in the contract specifications.

Following the final grading and compaction of the soil cover, topsoil will be placed to a minimum depth of six inches (after placement and rolling). Topsoil will not be placed when it is partially frozen, muddy, or when it is covered with ice, snow, or standing water. Topsoil will be placed and graded to a smooth, even surface and will be rolled and raked to remove ridges and fill in depressions, ruts and low spots that result after settlement. Grade stakes will be used to verify the thickness of the topsoil layer.

Topsoil placement, preparation for seeding, and spreading the seed will take place in a more or less continuous operation. Seed will be selected to provide a good stand of grass that will yield a desirable natural habitat cover. A suitable starter fertilizer will be applied with the seed to stimulate growth.

Permanent seed shall be installed immediately upon the completion of final grading. The seed mixture will be native to the area and provide a mixture of quick growth seed and annual seed to provide permanent stabilization to the site. The limit of the soil cover is depicted on Drawing C101.

2.6 Security, Control and Access

Security for the work, equipment, materials, supplies, facilities, personnel and incidentals, including the office trailers, will be provided throughout the performance of the work. The Site is surrounded by a fence. The fences and gates will be closed and locked when there is no activity on-site, and any breaks or gaps will be repaired immediately.

2.7 Health and Safety

A Site-Specific Health and Safety Plan (HASP) will be enforced at the Site in accordance with the requirements of 29 CFR 1910.120. The HASP will cover all on-site remediation activities. The remedial contractor will be required to develop and enforce a HASP.

2.7.1 Equipment and Personnel Decontamination Facilities

The remedial contractor will be required to install an equipment decontamination pad for the decontamination of equipment and vehicles during performance of the remedial construction. The decontamination pad will be large enough to contain wash water and debris from the largest-sized vehicles to be utilized, have a curbed perimeter and be underlain by an impervious liner. The remedial contractor will be required to ensure that all heavy equipment is clean prior to crossing areas which do not require remediation or have already been remediated, handling imported fill materials and prior to demobilizing.

The water used to decontaminate the equipment will be containerized and disposed off-site, after waste characterization. Collected sediments will be managed and consolidated on-site with other fill material.

2.7.2 Community Air Monitoring

Perimeter and work zone air monitoring will be performed in accordance with the CAMP and the remedial contractor's HASP to evaluate the effectiveness of dust and odor control measures. In general, real time air monitoring equipment will be utilized to monitor dust and total VOC levels. If visible dust is generated or work zone and/or perimeter air monitoring results are above action levels, corrective action measures will be implemented. Corrective action measures may include increasing water coverage,

controlling or temporarily ceasing select activities during high wind, reducing speed of equipment that may reduce dust generation, and utilizing different sizes or types of equipment that may cause less dust generation.

Dust control measures will be implemented to minimize the potential for dust generation during soil excavation and handling, and placement of fill. The main dust control device will include water applied via hoses or sprinklers connected to off-site hydrants. Truck routes exiting the Site will be continuously monitored for excessive dirt or dust, and heavily traveled truck routes will be wet down to minimize dust emissions. Other dust control devices/methods will be stabilized construction entrances/exits and proper cleaning of trucks.

Stabilized construction entrances/exits consisting of smoothly graded areas large enough to accommodate equipment and truck traffic will be constructed at exit points to clean tires of transport trucks exiting the Site. The base of the entrances/exits will be covered with non-woven geotextile (for non-slippage) and coarse aggregate and will be maintained and redressed while in use.

The entrances and exits will be inspected during high truck traffic periods for excessive dirt or dust. Proper cleaning of trucks exiting the Site will help control off-site dust on adjacent roadways. Transport trucks exiting the Site will pass through an inspection area and/or be inspected to ensure tires and undercarriages are clean and that tarps are secured. Excessive mud and loose dirt observed on the trucks will be manually removed with brooms and brushes as necessary.

2.8 Storm Water Management

Storm water management, soil erosion and sediment control will be performed in accordance with New York State Standards and Specifications for Soil Erosion and Sediment Control and the most recent NYSDEC Stormwater regulations (such as the SPDES General Permit for Stormwater Discharges for Construction Activities GP-0-20-001). The remedial contractor will be responsible for preventing off-site migration of stormwater during implementation of the remedy and compliance with all stormwater soil and erosion control measures.

If it will be necessary to stockpile fill material, it will be placed on bermed plastic liners and covered with plastic tarps to prevent erosion. Stockpiles of imported fill will also be placed on bermed liners and covered. Liners will be secured in place with stakes or concrete.

3.0 PERMITS AND OTHER AUTHORIZATIONS

Permits and approvals that may be required for construction include local permits for temporary utility connections, NYSDEC permits for mining of off-site fill sources, a permit for access drive improvements, and general construction permits. These will be the responsibility of the remedial contractor.

4.0 SCHEDULE

A preliminary schedule of key milestones for the remedial construction is provided below. Note that the following schedule is generic in nature, given the unknown time period regarding review and approval of the RDWP and the proposed remedial action. A schedule with estimated durations from the date of submittal of the RDWP is included in the following table.

Milestone	Estimated time from RDWP Submittal
Submit Draft RDWP	Week 0
Receive Comments from NYSDEC	Week 2
Submittal of Final Draft Remedial Work Plan	Week 5
NYSDEC Approval of Final Remedial Work Plan	Week 6
Submit Draft Plans and Specifications to the NYSDEC for Review and Comment	Week 10
Submit Final Detailed Plans and Specifications	Week 13
Release Contract Documents for Public Bidding	Week 18
Remedial Contractor Selection	Week 19
Contract Award	Week 20
Completion of Remedial Construction	Week 29
Submittal of the Draft Final Engineering Report and Draft Site Management Plan	Week 38
Receive NYSDEC Comments on Draft Final Engineering Report and Draft Site Management Plan	Week 42
Submittal of Certified Final Engineering Report and Final Site Management Plan	Week 46
NYSDEC Approval of Certified Final Engineering Report and Final Site Management Plan	Week 50

5.0 POST CONSTRUCTION PLANS

5.1 Institutional Controls

Due to the nature/composition of the soil and fill that will be left in place, Institutional Controls (ICs) will be required to restrict activities on the site after the remediation has been completed and to prevent potential exposure to groundwater, limit use to restricted-residential and ensure that the soil cover is properly maintained and contaminated soil remaining at the site is properly managed. The ICs will include any or a combination of the following:

- Site Management Plan; and
- An environmental easement pursuant to Title 36, Article 71 of the New York State Environmental Conservation Law.

The institutional controls will involve filing of an Environmental Easement which will preclude the use of groundwater as a source of potable or process water source and restrict activities on the Site that could compromise the integrity of the consolidation area cover.

The environmental easement will impose land use limitations or requirements that may be needed to protect current or future users from environmental contamination. Requirements and limitations may include restrictions on property uses, controls for certain site uses such as construction of basements or trenches, and/or operation or maintenance of engineering controls and reporting.

5.2 Site Management Plan

A Site Management Plan (SMP) will be prepared and submitted concurrent with completion of the remedial construction activities. The purpose of the Site Management Plan is to assure that proper procedures are in place to provide for long-term protection of human health and the environment after remedial construction is complete. Toward that end, the SMP is comprised of following main components:

- A summary of the site investigations and remedial actions
- An Institutional and Engineering Control Plan incorporating a description of all institutional and/or engineering controls employed at the site, including the mechanisms that will be used to continually implement, maintain, monitor, and enforce the controls. Engineering controls will be required as part of the final remedy in the form of the planned cover system for the soil cover area. As discussed in Section 5.1, institutional controls involving an easement that precludes the use of groundwater as a source of potable or process water source (unless groundwater quality standards are met) and restricts activities on the Site that could compromise the integrity of the cap will also be filed.

- A Monitoring and Sampling Plan, including separate appendices for the Field Sampling Plan, Quality Assurance Plan, and Health and Safety Plan. Remaining groundwater contamination is addressed through natural attenuation. To document decreases in groundwater contaminant concentration, groundwater monitoring will be required on a periodic basis following cover installation.
- A Maintenance Plan for maintaining the integrity of the soil cover.
- A description of periodic assessments and evaluations.
- A summary of reporting requirements.
- A Soil/Fill Management Plan identifying proper management of any residual impacted subsurface soil/fill that might be encountered during redevelopment or post-remedial construction activities at the Site, if undertaken. The Soil/Fill Management Plan (SFMP) will provide guidance for proper management of any residual impacted subsurface soil/fill that could be encountered during redevelopment or post-remedial construction activities within the original limits of the waste/fill, if undertaken. These may include activities such as infrastructure construction (i.e., roads, waterline, sewers, electric cable, etc.) or foundation excavation and Site grading. The SFMP will also include measures for handling site groundwater, if necessary for construction.
- A copy of the environmental Easement.

5.3 Final Engineering Report

A Final Engineering Report will be prepared at the conclusion to the remediation to document all remedial actions that have been undertaken at the Site. The report will be prepared in accordance with the DER-10, *Technical Guidance for Site Investigation and Remediation* (NYSDEC, 2010).

6.0 REFERENCES

Barton & Loguidice, P.C. (B&L). 2012. Interim Remedial Measures (IRM) Construction Completion Report.

Barton & Loguidice, D.P.C. (B&L). June 2014. Remedial Investigation Report

Barton & Loguidice, D.P.C. (B&L). May 2015. Alternative Analysis Report

New York Codes, Rules and Regulations (NYCRR). 2006. 6 NYCRR Part 375 Environmental Remediation Programs.

New York State Department of Environmental Conservation (NYSDEC). 2010. Technical Guidance for Site Investigation and Remediation (DER-10).

New York State Department of Environmental Remediation (NYSDER). February 2017. Record of Decision - 701 Lawrence Street, Operable Unit Number 01: Intersection of Luquer and Lawrence Streets Environmental Restoration Project.

Drawings

CITY OF ROME

ENVIRONMENTAL RESTORATION PROGRAM

701 LAWRENCE STREET

701 LAWRENCE STREET, ROME
ONEIDA COUNTY, NEW YORK

**Barton
&Loguidice**

SEPTEMBER 2021

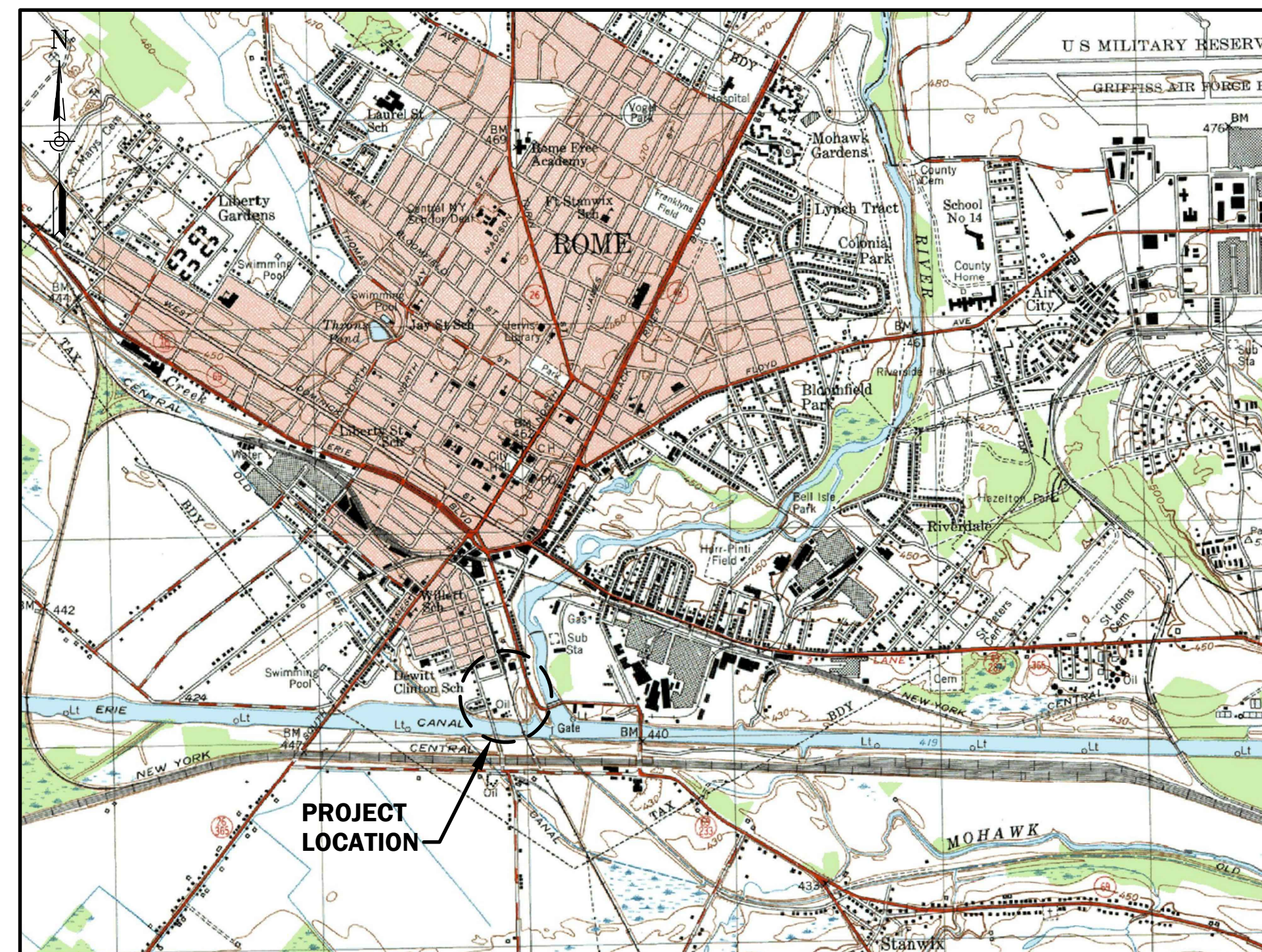

PROJECT LOCATION MAP

SCALE: 1" = 2,000'



IT IS A VIOLATION OF THE NEW YORK STATE EDUCATION LAW, ARTICLE 145 § 7209 SPECIAL PROVISIONS, FOR ANY PERSON, UNLESS THEY ARE ACTING UNDER THE DIRECTION OF A LICENSED PROFESSIONAL ENGINEER, ARCHITECT, LANDSCAPE ARCHITECT, OR LAND SURVEYOR, TO ALTER AN ITEM IN ANY WAY IF AN ITEM BEARING THE STAMP OF A LICENSED PROFESSIONAL IS ALTERED, THE ALTERING PROFESSIONAL SHALL STAMP THE DOCUMENT AND INCLUDE THE NOTATION "ALTERED BY" FOLLOWED BY THEIR SIGNATURE, THE DATE OF SUCH ALTERATION, AND A SPECIFIC DESCRIPTION OF THE ALTERATION.

DRAWING INDEX	
SHEET NUMBER	SHEET TITLE
G001	COVER SHEET
G002	GENERAL NOTES
C100	EXISTING CONDITIONS PLAN
C101	EROSION, SEDIMENT, AND STORMWATER CONTROL PLAN
C102	SUBGRADE GRADING PLAN
C103	FINAL GRADING AND SOIL COVER PLAN
C501	SECTIONS
C502	COVER SYSTEM DETAILS
C503	EROSION AND SEDIMENT CONTROL DETAILS

NOTES

- HORIZONTAL DATUM IS BASED UPON THE NEW YORK STATE PLANE COORDINATE SYSTEM, CENTRAL ZONE, NORTH AMERICAN DATUM OF 1983 (NAD83).
- VERTICAL DATUM IS BASED UPON THE NORTH AMERICAN VERTICAL DATUM OF 1988 (NAVD88).
- TOPOGRAPHIC SURVEY INCLUDING CONTOUR ELEVATION, DATED JUNE 15, 2021, PREPARED BY B&L. PROPERTY BOUNDARY INFORMATION, DATED DECEMBER 15, 2016, PREPARED BY SUSAN M. ANACKER, L.S. LIC # 50321.
- THE CONTRACTOR SHALL FURNISH ALL LABOR, FACILITIES, POWER AND INCIDENTALS NECESSARY TO FULLY COMPLETE THE WORK AS SHOWN, AS SPECIFIED AND AS DIRECTED BY B&L. THE CONTRACTOR SHALL BE RESPONSIBLE FOR PERFORMING ALL WORK DESCRIBED IN THE CONTRACT DOCUMENTS, INCLUDING ITEMS NOT SPECIFICALLY IDENTIFIED, AS REQUIRED TO COMPLETE THE WORK.
- ALL WORK SHALL BE PERFORMED IN ACCORDANCE WITH APPLICABLE FEDERAL, STATE AND LOCAL LAWS AND REGULATIONS, AND THE CONTRACTOR'S APPROVED SUBMITTALS. IF ANY LAW, REGULATION AND/OR CONTRACT DOCUMENTS HAVE CONTRADICTING REQUIREMENTS, THEN THE MOST STRINGENT REQUIREMENT SHALL APPLY AS DETERMINED BY B&L. LOCAL LAWS SHALL INCLUDE ANY CITY OR OTHER LOCAL REGULATORY AUTHORITY HAVING JURISDICTION.
- THE CONTRACTOR IS RESTRICTED FROM PERFORMING ANY OPERATIONS OUTSIDE THE DEFINED CONTRACT LIMITS UNLESS OTHERWISE APPROVED BY B&L AND THE CITY OF ROME.
- THE CONTRACTOR SHALL IDENTIFY, APPLY FOR AND OBTAIN, PAY ALL FEES FOR, AND COMPLY WITH ALL REQUIREMENTS OF ALL ISSUED LICENSES, PERMITS, APPROVALS AND INSURANCE REQUIRED FROM FEDERAL, STATE AND LOCAL GOVERNMENT AND PUBLIC AGENCIES AND AUTHORITIES NECESSARY TO PERFORM THE WORK. THE CONTRACTOR SHALL PROVIDE INDEMNIFICATION TO PUBLIC AND PRIVATE AGENCIES AND AUTHORITIES AS NECESSARY TO PERFORM THE WORK.
- THE CONTRACTOR SHALL BE RESPONSIBLE FOR ALL PERMITS THAT ARE REQUIRED PRIOR TO COMMENCING CONSTRUCTION, EXCEPT AS NOTED IN THE CONTRACT DOCUMENTS.
- THE CONTRACTOR SHALL FIELD VERIFY ALL DIMENSIONS AND CONDITIONS BEFORE COMMENCING WORK. EXISTING DIMENSION AND ELEVATION INFORMATION PRESENTED ON THESE DRAWINGS SHALL BE VERIFIED BY THE CONTRACTOR BY ACTUAL FIELD MEASUREMENTS. IT IS THE CONTRACTOR'S RESPONSIBILITY TO REPORT ANY DISCREPANCIES TO B&L AND THE CITY OF ROME IN A TIMELY MANNER. FAILURE TO PROSPECT IN ADVANCE OF WORK OR VERIFY DIMENSIONS SHALL NOT BE CAUSE FOR ADDITIONAL COSTS TO THE CITY OF ROME AND B&L.
- UNDERGROUND FACILITIES, STRUCTURES, AND UTILITIES HAVE BEEN PLOTTED FROM DATA OBTAINED FROM PREVIOUS MAPS AND RECORD DRAWINGS. SURFACE FEATURES SUCH AS CATCH BASIN RIMS, MANHOLE COVERS, WATER VALVES, GAS VALVES, ETC. ARE THE RESULT OF FIELD SURVEY UNLESS NOTED OTHERWISE. THERE MAY BE OTHER UNDERGROUND UTILITIES, THE EXISTENCE OF WHICH IS NOT KNOWN. SIZE AND LOCATION OF ALL UNDERGROUND UTILITIES AND STRUCTURES MUST BE VERIFIED BY THE APPROPRIATE AUTHORITIES. A UTILITY MARK-OUT MUST BE CONDUCTED PRIOR TO CONDUCTING TEST BORINGS, EXCAVATION AND CONSTRUCTION.
- EXISTING UTILITIES AND BURIED PIPING LOCATIONS AND ELEVATIONS SHOWN ON THE DRAWINGS ARE APPROXIMATE AND ARE INTENDED ONLY TO INDICATE THE EXISTENCE OF SUCH UTILITIES AND PIPING IN AREA SHOWN. THE EXISTENCE AND LOCATION OF ANY UTILITIES INDICATED ON THE PLANS ARE NOT GUARANTEED AND SHALL BE INVESTIGATED AND VERIFIED IN THE FIELD BY THE CONTRACTOR BEFORE STARTING WORK. BEFORE PROCEEDING WITH WORK, THE CONTRACTOR SHALL VERIFY UTILITIES AND PIPING LOCATIONS IN THE FIELD AND NOTIFY B&L OF ANY DISCREPANCIES. PUBLIC AND PRIVATE UTILITIES SHALL BE LOCATED BY THE CONTRACTOR, AT NO ADDITIONAL COST TO THE CITY OF ROME AND B&L. THE CONTRACTOR SHALL NOTIFY THE APPROPRIATE UTILITY COMPANY NO LATER THAN 48 HOURS PRIOR TO ANY EXCAVATION THAT MAY AFFECT THAT UTILITY. EXCAVATION IN THE TOLERANCE ZONES OF UNDERGROUND UTILITIES SHALL BE DUG BY HAND IN ACCORDANCE WITH UTILITY SPECIFICATIONS. THE CONTRACTOR WILL BE HELD RESPONSIBLE FOR ANY DAMAGE TO EXISTING UTILITIES.
- THE CONTRACTOR SHALL NOTIFY THE CITY OF ROME AND B&L A MINIMUM OF FIVE (5) DAYS PRIOR TO THE START OF CONSTRUCTION. IN ADDITION, IF ANY WORK SHOULD BE STOPPED AND RESTARTED FOR ANY REASON, THE CONTRACTOR SHALL GIVE THE CITY OF ROME AND B&L A MINIMUM FIVE (5) DAYS NOTICE.
- THE CONTRACTOR SHALL PERFORM DAILY CLEANUP OPERATIONS WHICH INCLUDE REMOVAL OF DEBRIS (CUPS, PAPER BAGS, CANS, ETC.), REMOVAL OF EXCESS CONSTRUCTION MATERIALS, ALL TO THE SATISFACTION OF THE CITY OF ROME AND B&L THROUGHOUT THE CONTRACT DURATION.
- DURING CONSTRUCTION, THE CONTRACTOR SHALL MAINTAIN TRAFFIC ON ALL ROADWAYS ADJACENT TO OR WHERE WORK IS IN PROGRESS. ALL ROADWAYS SHALL REMAIN OPEN AND ACCESSIBLE TO ALL, EXCEPT AS OTHERWISE SPECIFIED OR APPROVED. NO ROADWAY CLOSURES SHALL BE ALLOWED AS PART OF THE CONTRACT. AS A MINIMUM, ONE LANE ALTERNATING TRAFFIC SHALL BE MAINTAINED AT ALL TIMES. ROADWAYS SHALL BE RESTORED TO FULL TRAFFIC PATTERN FLOWS AT THE END OF EACH WORK DAY.
- ALL CONSTRUCTION OPERATIONS SHALL BE ACCOMPLISHED IN ACCORDANCE WITH APPLICABLE STATE AND LOCAL STATUTES AND U.S. OCCUPATIONAL SAFETY AND HEALTH ADMINISTRATION REGULATIONS (O.S.H.A.). COPIES OF O.S.H.A.'S STANDARDS MAY BE PURCHASED FROM THE U.S. GOVERNMENT PRINTING OFFICE. THE CONTRACTOR ALONE WILL BE RESPONSIBLE FOR THE EXECUTION OF THE WORK IN ACCORDANCE WITH ALL APPLICABLE HEALTH AND SAFETY REGULATIONS.
- THE CONTRACTOR SHALL RESTORE LAWNS, DRIVEWAYS, GUIDERAILS, WALKS, CURBS, FENCES, AND OTHER PHYSICAL FEATURES TO A CONDITION AT LEAST AS GOOD AS THEY WERE BEFORE BEING DISTURBED. ALL STRUCTURES SHALL BE PROTECTED OR REMOVED AND REPLACED EXACTLY AS THEY WERE BEFORE BEING DISTURBED. DAMAGED ITEMS SHALL BE REPLACED AT THE CONTRACTORS EXPENSE.
- PRIOR TO SUBMITTING A RESPONSIBLE BID, THE CONTRACTOR SHALL VISIT THE SITE AND BE FAMILIAR WITH THE EXISTING CONDITIONS.
- THE CONTRACTOR SHALL DEVELOP AND FOLLOW ITS OWN SITE-SPECIFIC HEALTH AND SAFETY PLAN AND USE PPE.

CONSTRUCTION SEQUENCE

THE SEQUENCE OF CONSTRUCTION IS A GENERAL OVERVIEW OF THE PHASING AND SHALL BE ADHERED TO. IT DOES NOT RELIEVE THE CONTRACTOR OF PROVIDING A DETAILED CONSTRUCTION SCHEDULE TO B&L FOR APPROVAL, AS REQUIRED IN THE SPECIFICATIONS. IT ALSO DOES NOT RELIEVE THE CONTRACTOR OF PERFORMING ALL THE WORK AS SHOWN ON THE PLANS AND INCLUDED IN THE SPECIFICATIONS.

THE CONTRACTOR SHALL BE RESPONSIBLE FOR ENSURING COMPLIANCE WITH ALL CONDITIONS AND NOTIFICATION REQUIREMENTS OF ISSUED PERMITS AND PERMITS OBTAINED BY THE CITY OF ROME FOR COMPLETION OF THE WORK.

GENERAL

- PERFORM UNDERGROUND UTILITY MARK-OUT SURVEY IN ACCORDANCE WITH THE REQUIREMENTS OUTLINED IN THE CONTRACT DOCUMENTS.
- PERFORM INITIAL SITE SURVEY IN ACCORDANCE WITH THE REQUIREMENTS OUTLINED IN THE CONTRACT DOCUMENTS.
- PROTECT EXISTING ABOVE GROUND STRUCTURES, UNDERGROUND UTILITIES AND STRUCTURES LOCATED OUTSIDE THE LIMITS OF EXCAVATION AND GRADING.
- MAINTENANCE OR INSTALLATION OF PERMANENT AND TEMPORARY PERIMETER SECURITY FENCE AS NOTED ON THE CONTRACT DRAWINGS. FOR THE PURPOSES OF THIS CONTRACT, PERMANENT FENCE SHALL BE DEFINED AS THAT PORTION OF THE SECURITY FENCE THAT WILL REMAIN IN PLACE THROUGHOUT THE DURATION OF THIS CONTRACT. THE PERMANENT FENCE WAS INSTALLED BY OTHERS. TEMPORARY FENCE SHALL BE DEFINED AS THAT PORTION OF THE SECURITY FENCE THAT WILL BE INSTALLED BY THE CONTRACTOR DURING THE WORK AND REMAIN IN PLACE UNTIL SUBSTANTIAL COMPLETION. TEMPORARY FENCE SHALL BE REMOVED BY THE CONTRACTOR UNDER THIS CONTRACT.
- SEDIMENT, EROSION AND STORMWATER CONTROL MEASURES SHALL BE INSTALLED IN ACCORDANCE WITH THE ENGINEER-APPROVED STORMWATER POLLUTION PREVENTION PLAN.
- INSTALL STABILIZED CONSTRUCTION ENTRANCE AS SPECIFIED.
- INSTALL TEMPORARY VEHICLE DECONTAMINATION AREA AS SPECIFIED.
- INSTALL TRAILER(S), TEMPORARY ELECTRIC, UTILITIES, ACCESS ROADS AND PARKING AS SPECIFIED.
- CLEARING AND GRUBBING OF DESIGNATED AREAS AS REQUIRED TO PERFORM THE REMEDIAL WORK ON-SITE. OFF-SITE TRANSPORTATION AND DISPOSAL OF CLEARED TREES AND ROOTS.
- DECOMMISSION ALL ON-SITE MONITORING WELLS IN ACCORDANCE WITH THE CONTRACT DOCUMENTS.
- EXCAVATE AND GRADE OF DESIGNATED SITE SOILS TO THE LIMITS AND GRADES AS SHOWN ON THE CONTRACT DRAWINGS TO ACHIEVE THE GRADE SHOWN IN THE CONTRACT DRAWINGS.
- DEWATER, IF NECESSARY, THE EXCAVATIONS AND DISPOSE OF ALL WATER IN ACCORDANCE WITH ALL APPLICABLE REGULATIONS AND THE CONTRACT DOCUMENTS.
- PERFORM POST-EXCAVATION SURVEY IN ACCORDANCE WITH THE CONTRACT DOCUMENTS.
- OBTAIN ACCEPTABLE BACKFILL AND PERFORM RESTORATION OF DESIGNATED AREAS TO PROPOSED CONTOURS WITH A COMBINATION OF COMMON BACKFILL, TOPSOIL, AND VEGETATION.
- FINAL GRADING AND VEGETATION OF THE SITE IN ACCORDANCE WITH THE CONTRACT DOCUMENTS.
- MAINTAIN SEEDED AND SODDED AREAS THROUGHOUT THE WARRANTY PERIOD INCLUDING BUT NOT NECESSARILY LIMITED TO WATERING, MOWING, AND REPAIR OF DAMAGED AREAS OR DEAD AREAS.
- DEMOBILIZATION: REMOVE FROM SITE ALL CONTRACTOR EQUIPMENT, CONSTRUCTION FACILITIES AND UTILITIES CONNECTIONS, AND RESTORE SITE TO ORIGINAL OR SPECIFIED CONDITIONS.
- PROTECT AND MAINTAIN THE WORK AS REQUIRED.
- PERFORM ALL OTHER ACTIVITIES NOT SPECIFICALLY DISCUSSED HEREIN BUT NECESSARY TO SATISFACTORILY COMPLETE ALL WORK REQUIRED BY THE CONTRACT DOCUMENTS, CONTRACT DRAWINGS, ENGINEER, AND CITY OF ROME.
- PERFORM ALL WORK ASSOCIATED WITH CONTRACT CLOSEOUT.

IT IS A VIOLATION OF THE NEW YORK STATE EDUCATION LAW, ARTICLE 145 §7209 SPECIAL PROVISIONS, FOR ANY PERSON, UNLESS THEY ARE ACTING UNDER THE DIRECTION OF A LICENSED PROFESSIONAL ENGINEER, ARCHITECT, LANDSCAPE ARCHITECT, OR LAND SURVEYOR, TO ALTER AN ITEM IN ANY WAY. IF AN ITEM BEARING THE STAMP OF A LICENSED PROFESSIONAL IS ALTERED, THE ALTERING PROFESSIONAL SHALL STAMP THE DOCUMENT AND INCLUDE THE NOTATION "ALTERED BY" FOLLOWED BY THEIR SIGNATURE, THE DATE OF SUCH ALTERATION, AND A SPECIFIC DESCRIPTION OF THE ALTERATION.

REVISIONS

NO.	DATE	DESCRIPTION

CITY OF ROME
 ENVIRONMENTAL RESTORATION PROGRAM
 701 LAWRENCE STREET
GENERAL NOTES
 ONEIDA COUNTY, NEW YORK

CITY OF ROME



10 Airtime Drive
 Suite 200
 Albany, NY
 12205

Barton & Loguidice, D.P.C.



Date

SEPTEMBER 2021

Scale

AS SHOWN

Sheet Number

G002

Project Number

245.005.016



LEGEND

	PROPERTY LINE
	EXISTING MAJOR CONTOUR
	EXISTING MINOR CONTOUR
	EXISTING OVERHEAD ELECTRIC LINE
	EXISTING FENCE
	EXISTING TRAIN TRACKS
	EXISTING MONITORING WELL LOCATION
	EXISTING UTILITY POLE



IT IS A VIOLATION OF THE NEW YORK STATE EDUCATION LAW, ARTICLE 145 § 7209 SPECIAL PROVISIONS, FOR ANY PERSON, UNLESS THEY ARE ACTING UNDER THE DIRECTION OF A LICENSED PROFESSIONAL ENGINEER, ARCHITECT, LANDSCAPE ARCHITECT, OR LAND SURVEYOR, TO ALTER AN ITEM IN ANY WAY. IF AN ITEM BEARING THE STAMP OF A LICENSED PROFESSIONAL IS ALTERED, THE ALTERING PROFESSIONAL SHALL STAMP THE DOCUMENT AND INCLUDE THE NOTATION "ALTERED BY" FOLLOWED BY THEIR SIGNATURE, THE DATE OF SUCH ALTERATION, AND A SPECIFIC DESCRIPTION OF THE ALTERATION.

REVISIONS

CITY OF ROME
 ENVIRONMENTAL RESTORATION PROGRAM
 701 LAWRENCE STREET
EXISTING SITE CONDITIONS PLAN
 ONEIDA COUNTY, NEW YORK

10 Airline Drive
 Suite 200
 Albany, NY
 12205
Barton & Loguidice, D.P.C.

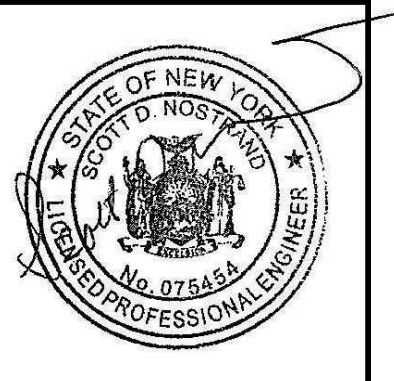

Date: SEPTEMBER 2021
 Scale: 1" = 20'
 Sheet Number: **C100**
 Project Number: 245.005.016

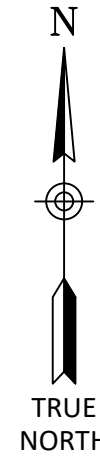

NOTES:

1. THE CONTRACTOR SHALL DEVELOP AND FOLLOW ITS OWN SITE-SPECIFIC HEALTH AND SAFETY PLAN AND USE APPROPRIATE PPE.
2. THE CONTRACTOR SHALL FOLLOW ALL REQUIREMENTS, INCLUDING THE ACQUISITION OF REQUIRED PERMITS OF THE LOCAL MUNICIPALITY, COUNTY, AND STATE WHEN WORKING IN THEIR RIGHT-OF-WAY.
3. THE CONTRACTOR SHALL CLEAR AND GRUB EXISTING VEGETATION TO THE EXTENT NECESSARY FOR THE COMPLETION OF WORK UNLESS OTHERWISE SHOWN. CONSOLIDATE, CATEGORIZE, AND DISPOSE OF ALL DEBRIS ENCOUNTERED.
4. THE CONTRACTOR SHALL ACCESS THE SITE FROM LAWRENCE STREET.
5. THE CONTRACTOR SHALL INSTALL THE STABILIZED CONSTRUCTION ENTRANCE AND TEMPORARY VEHICLE DECONTAMINATION AREA PRIOR TO PERFORMING ANY WORK OR RECEIVING ANY MATERIALS WITHIN THE SITE.
6. THE CONTRACTOR SHALL ESTABLISH THE COMMUNITY AIR MONITORING PROGRAM PRIOR TO CLEARING, GRUBBING OR SITE GRADING ACTIVITIES.
7. THE CONTRACTOR IS RESPONSIBLE FOR MAINTAINING ALL SEDIMENT AND STORM WATER CONTROLS DURING THE WORK. CONTRACTOR MAY BEGIN CLEARING TREES AND VEGETATION PRIOR TO INSTALLATION OF SILT FENCING.
8. NO DISTURBANCE OF THE SOIL (I.E. GRADING, EXCAVATING, ETC.) SHALL BE PERMITTED UNTIL THE CONTRACTOR COMPLETES THE INSTALLATION OF SILT FENCE, TEMPORARY STABILIZED CONSTRUCTION ENTRANCE, AND TEMPORARY VEHICLE DECONTAMINATION AREA.
9. THE SILT FENCING SHOWN ON THIS DRAWING IS APPROXIMATE AND SHALL BE INSTALLED IN THE GENERAL LOCATIONS AS SHOWN AND AS DIRECTED BY ENGINEER IN THE FIELD.
10. EQUIPMENT USED ON SITE OR TRUCKS DELIVERING MATERIAL ON SITE, SHALL BE DECONTAMINATED PRIOR TO LEAVING THE SITE.
11. THE CONTRACTOR SHALL INSTALL ADDITIONAL TEMPORARY VEHICLE DECONTAMINATION AREAS AS NECESSARY TO DECONTAMINATE ANY VEHICLES OR EQUIPMENT LEAVING CONTAMINATED AREAS.
12. EXISTING TREES NOT REMOVED SHALL BE PROTECTED FROM DAMAGE DURING CONSTRUCTION.

LEGEND

	PROPERTY LINE
	EXISTING MAJOR CONTOUR
	EXISTING MINOR CONTOUR
	EXISTING OVERHEAD ELECTRIC LINE
	EXISTING FENCE
	EXISTING TRAIN TRACKS
	EXISTING UTILITY POLE
	SILT FENCE
	PROPOSED LIMIT OF SOIL COVER
	LIMIT OF WORK AREA
	SUBGRADE MAJOR CONTOUR
	SUBGRADE MINOR CONTOUR
	EXISTING MONITORING WELL TO BE DECOMMISSIONED
	EXISTING MONITORING WELL TO BE PROTECTED

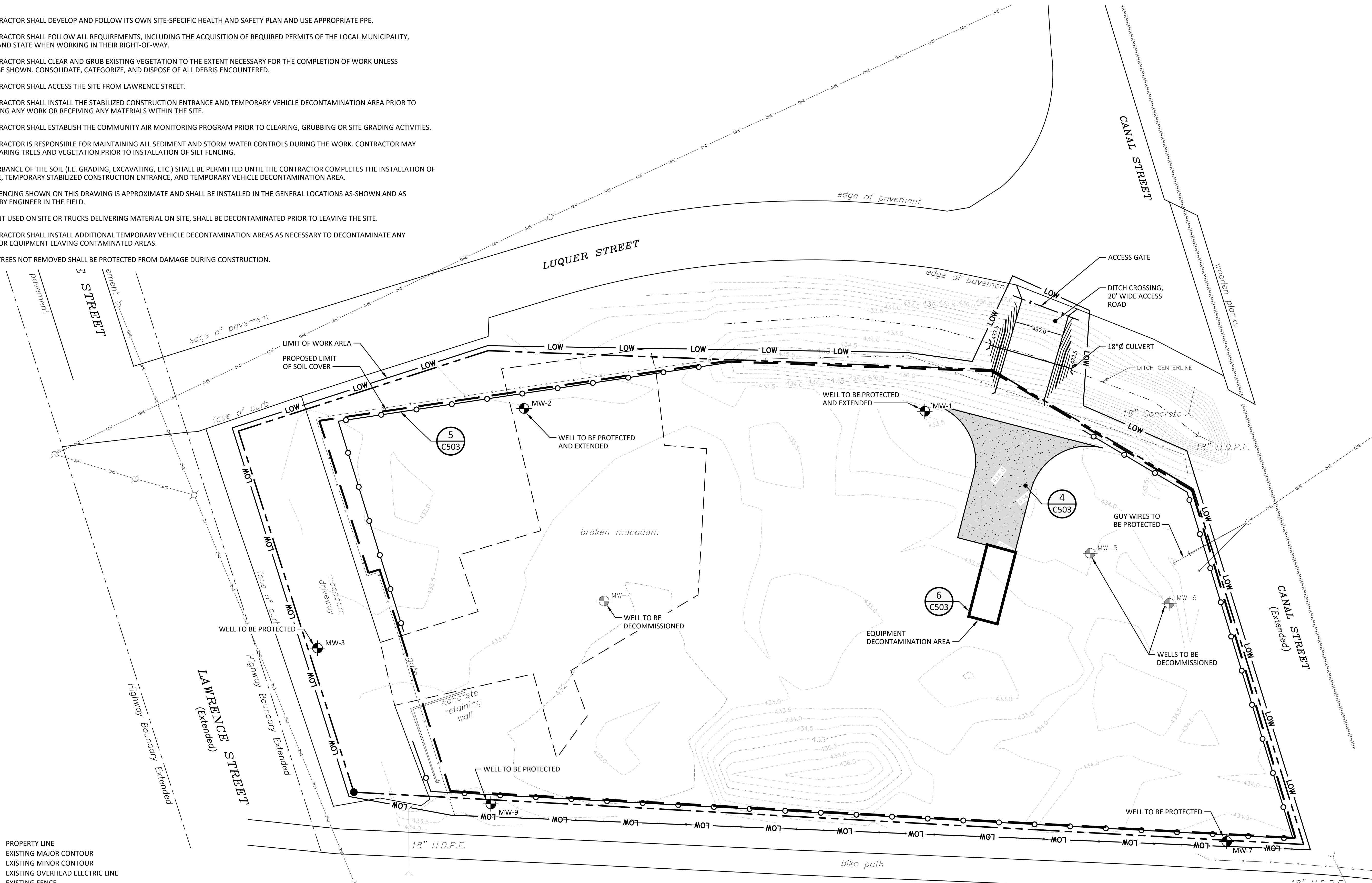

IT IS A VIOLATION OF THE NEW YORK STATE EDUCATION LAW, ARTICLE 145 §7209 SPECIAL PROVISIONS FOR ANY PERSON, UNLESS THEY ARE ACTING UNDER THE DIRECTION OF A LICENSED PROFESSIONAL ENGINEER, ARCHITECT, LANDSCAPE ARCHITECT, OR LAND SURVEYOR, TO ALTER AN ITEM IN ANY WAY. IF AN ITEM BEARING THE STAMP OF A LICENSED PROFESSIONAL IS ALTERED, THE ALTERING PROFESSIONAL SHALL STAMP THE DOCUMENT AND INCLUDE THE NOTATION "ALTERED BY" FOLLOWED BY THEIR SIGNATURE, THE DATE OF SUCH ALTERATION, AND A SPECIFIC DESCRIPTION OF THE ALTERATION.

REVISIONS

NO.	DESCRIPTION

CITY OF ROME
 ENVIRONMENTAL RESTORATION PROGRAM
 701 LAWRENCE STREET
EROSION, SEDIMENT, AND STORMWATER CONTROL PLAN
 CITY OF ROME
 ONEIDA COUNTY, NEW YORK

B & L
 Barton & Loguidice, D.P.C.
 10 Airtime Drive
 Suite 200
 Albany, NY
 12205

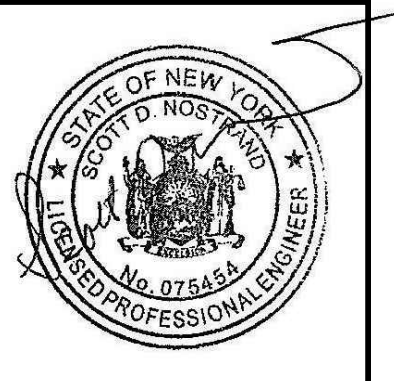

Date: SEPTEMBER 2021
 Scale: 1" = 20'
 Sheet Number: **C101**
 Project Number: 245.005.016



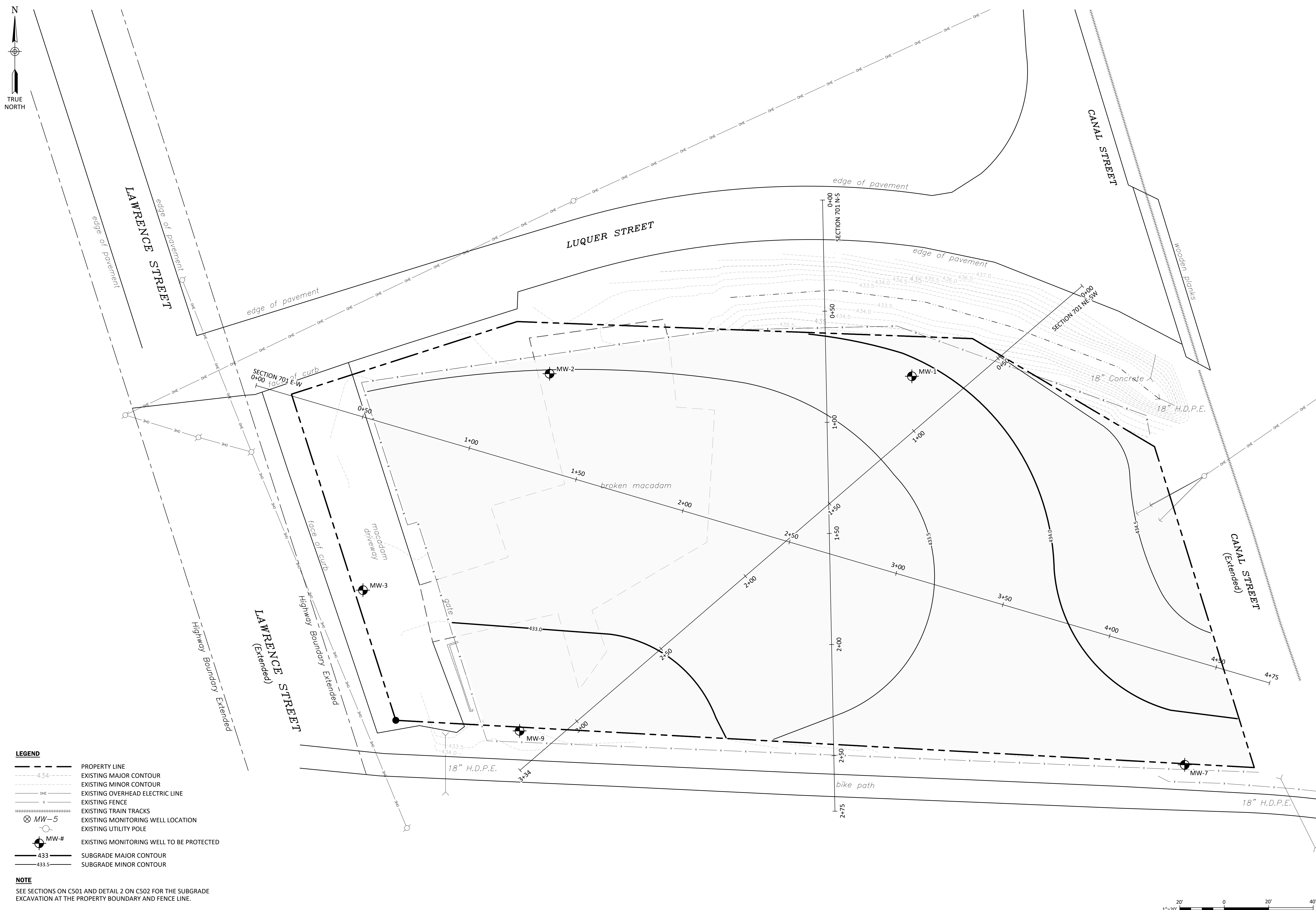

- LEGEND**
- PROPERTY LINE
 - - - - - EXISTING MAJOR CONTOUR
 - - - - - EXISTING MINOR CONTOUR
 - - - - - EXISTING OVERHEAD ELECTRIC LINE
 - - - - - EXISTING FENCE
 - - - - - EXISTING TRAIN TRACKS
 - ⊗ MW-# EXISTING MONITORING WELL LOCATION
 - ⊗ MW-# EXISTING UTILITY POLE
 - ⊗ MW-# EXISTING MONITORING WELL TO BE PROTECTED
 - - - - - 433 SUBGRADE MAJOR CONTOUR
 - - - - - 433.5 SUBGRADE MINOR CONTOUR

NOTE
 SEE SECTIONS ON C501 AND DETAIL 2 ON C502 FOR THE SUBGRADE EXCAVATION AT THE PROPERTY BOUNDARY AND FENCE LINE.



IT IS A VIOLATION OF THE NEW YORK STATE EDUCATION LAW, ARTICLE 145 §7209 SPECIAL PROVISIONS, FOR ANY PERSON, UNLESS THEY ARE ACTING UNDER THE DIRECTION OF A LICENSED PROFESSIONAL ENGINEER, ARCHITECT, LANDSCAPE ARCHITECT, OR LAND SURVEYOR, TO ALTER AN ITEM IN ANY WAY. IF AN ITEM BEARING THE STAMP OF A LICENSED PROFESSIONAL IS ALTERED, THE ALTERING PROFESSIONAL SHALL STAMP THE DOCUMENT AND INCLUDE THE NOTATION "ALTERED BY" FOLLOWED BY THEIR SIGNATURE, THE DATE OF SUCH ALTERATION, AND A SPECIFIC DESCRIPTION OF THE ALTERATION.

NO.	DATE	DESCRIPTION

CITY OF ROME
 ENVIRONMENTAL RESTORATION PROGRAM
 701 LAWRENCE STREET
SUBGRADE GRADING PLAN
 ONEIDA COUNTY, NEW YORK

10 Airline Drive
 Suite 200
 Albany, NY
 12205
Barton & Loguidice, D.P.C.



Date: SEPTEMBER 2021
 Scale: 1" = 20'
 Sheet Number: **C102**
 Project Number: 245.005.016

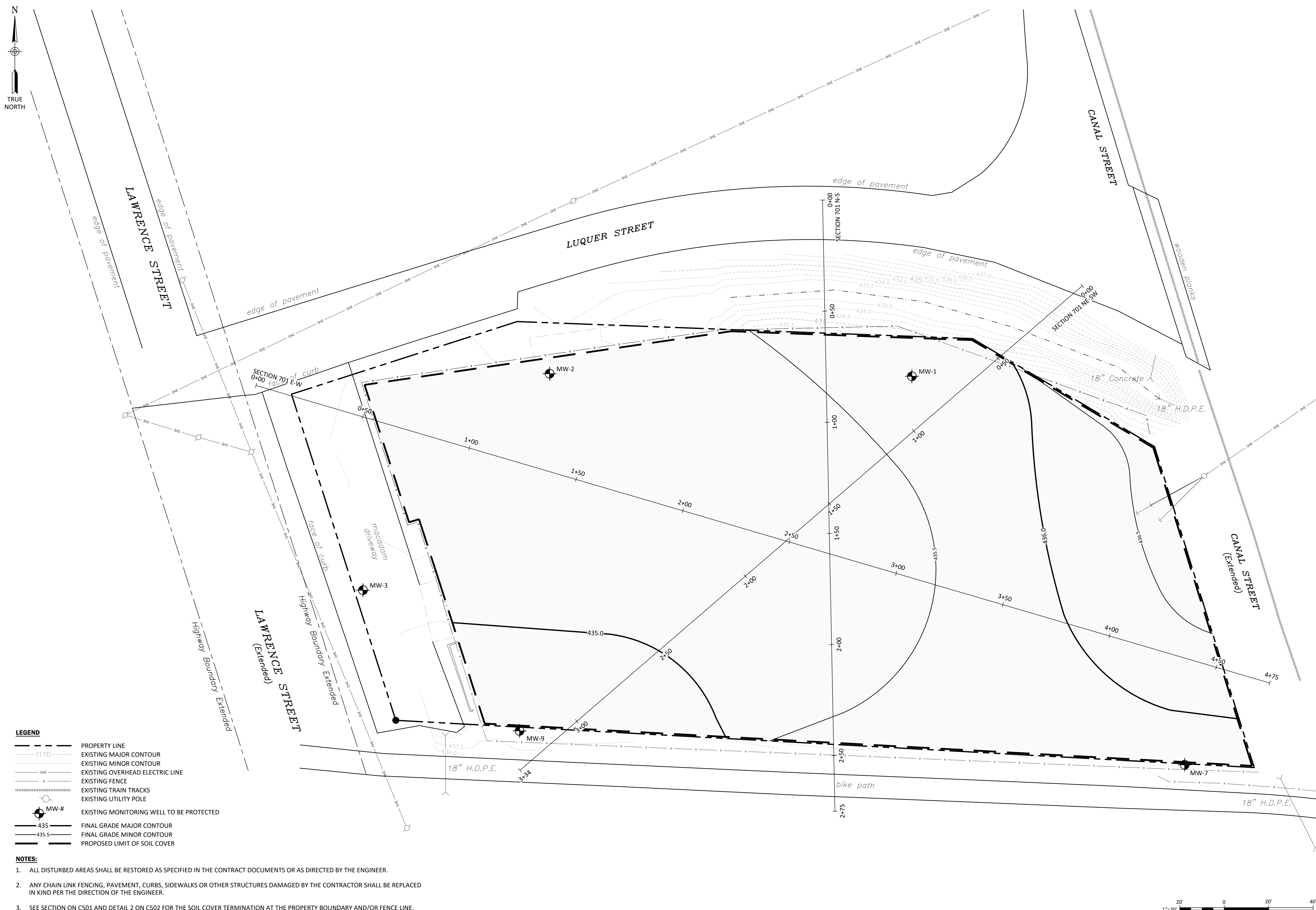

LEGEND

	PROPERTY LINE
	EXISTING MAJOR CONTOUR
	EXISTING MINOR CONTOUR
	EXISTING OVERHEAD ELECTRIC LINE
	EXISTING FENCE
	EXISTING TRAIN TRACKS
	EXISTING UTILITY POLE
	MW-# EXISTING MONITORING WELL TO BE PROTECTED
	435 FINAL GRADE MAJOR CONTOUR
	435.5 FINAL GRADE MINOR CONTOUR
	PROPOSED LIMIT OF SOIL COVER

- NOTES:**
- ALL DISTURBED AREAS SHALL BE RESTORED AS SPECIFIED IN THE CONTRACT DOCUMENTS OR AS DIRECTED BY THE ENGINEER.
 - ANY CHAIN LINK FENCING, PAVEMENT, CURBS, SIDEWALKS OR OTHER STRUCTURES DAMAGED BY THE CONTRACTOR SHALL BE REPLACED IN KIND PER THE DIRECTION OF THE ENGINEER.
 - SEE SECTION ON C501 AND DETAIL 2 ON C502 FOR THE SOIL COVER TERMINATION AT THE PROPERTY BOUNDARY AND/OR FENCE LINE.

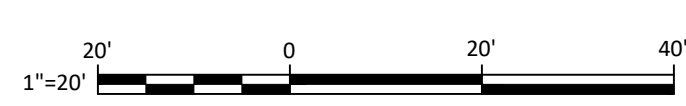

IT IS A VIOLATION OF THE NEW YORK STATE EDUCATION LAW, ARTICLE 145 §7209 SPECIAL PROVISIONS, FOR ANY PERSON, UNLESS THEY ARE ACTING UNDER THE DIRECTION OF A LICENSED PROFESSIONAL ENGINEER, ARCHITECT, LANDSCAPE ARCHITECT, OR LAND SURVEYOR, TO ALTER AN ITEM IN ANY WAY. IF AN ITEM BEARING THE STAMP OF A LICENSED PROFESSIONAL IS ALTERED, THE ALTERING PROFESSIONAL SHALL STAMP THE DOCUMENT AND INCLUDE THE NOTATION "ALTERED BY" FOLLOWED BY THEIR SIGNATURE, THE DATE OF SUCH ALTERATION, AND A SPECIFIC DESCRIPTION OF THE ALTERATION.

REVISIONS

NO.	DESCRIPTION

CITY OF ROME
 ENVIRONMENTAL RESTORATION PROGRAM
 701 LAWRENCE STREET
FINAL GRADING AND SOIL COVER PLAN
 ONEIDA COUNTY, NEW YORK

10 Airline Drive
 Suite 200
 Albany, NY
 12205
Barton & Loguidice, D.P.C.



Date: SEPTEMBER 2021
 Scale: 1" = 20'
 Sheet Number: **C103**
 Project Number: 245.005.016

- LEGEND**
- EXISTING GRADE
 - - - SUBGRADE
 - FINAL GRADE
 - x - FENCE
 - - - PROPERTY LINE

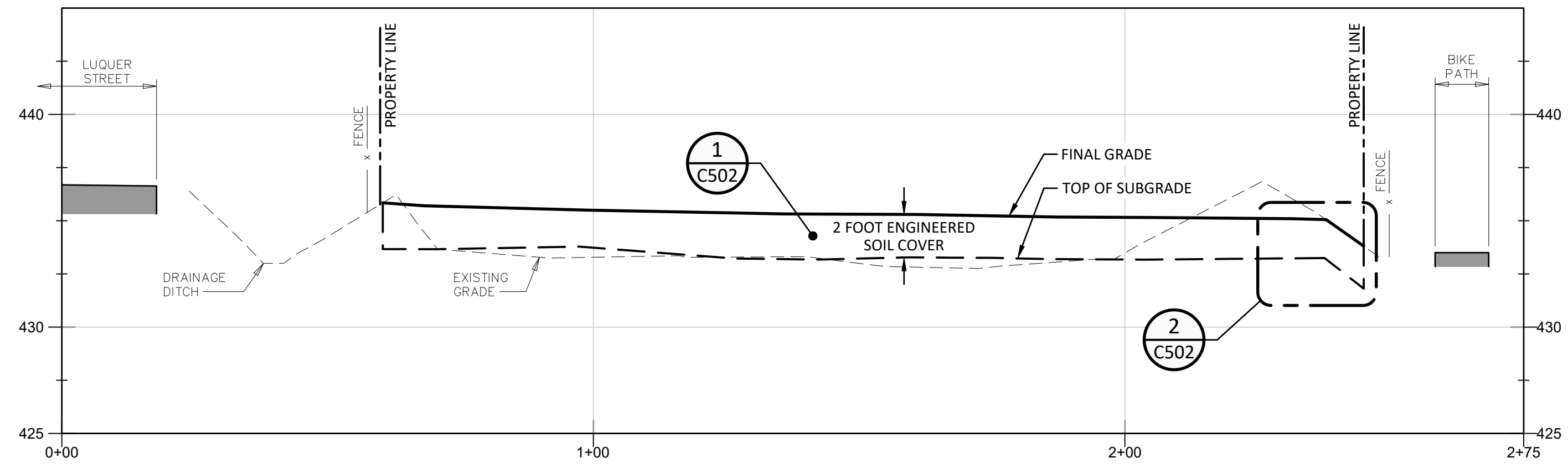

SECTION 701 N-S

HORIZONTAL SCALE: 1" = 20"
VERTICAL SCALE: 1" = 5'

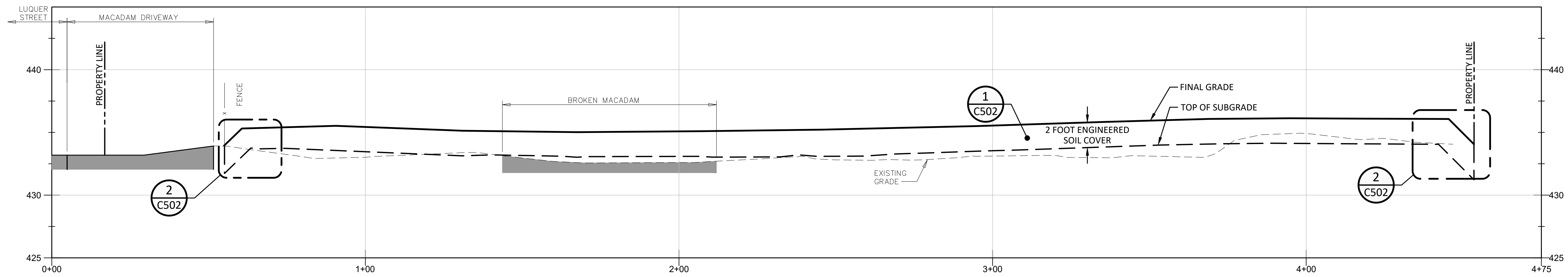

SECTION 701 E-W

HORIZONTAL SCALE: 1" = 20"
VERTICAL SCALE: 1" = 5'

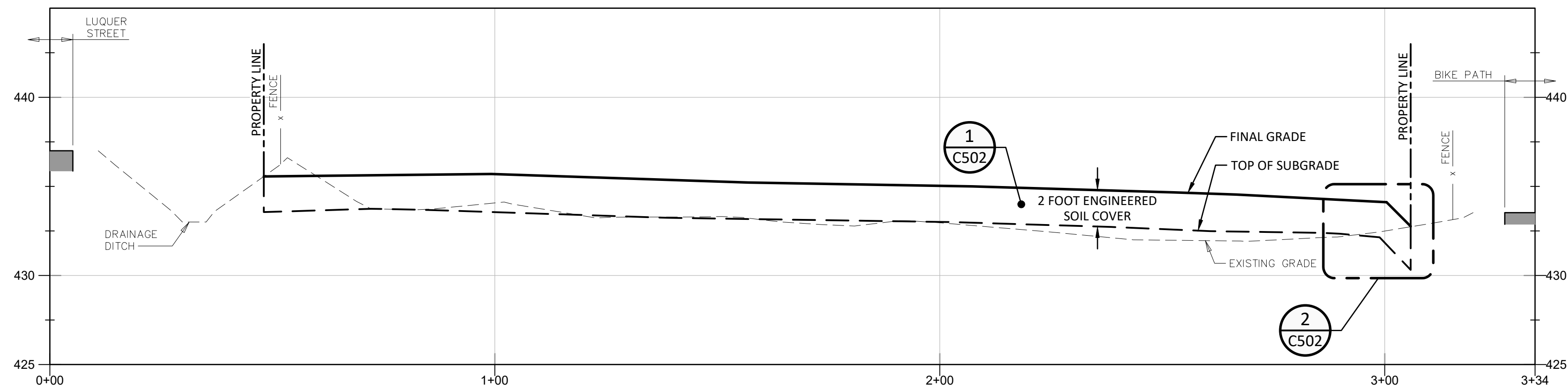

SECTION 701 NE-SW

HORIZONTAL SCALE: 1" = 20"
VERTICAL SCALE: 1" = 5'

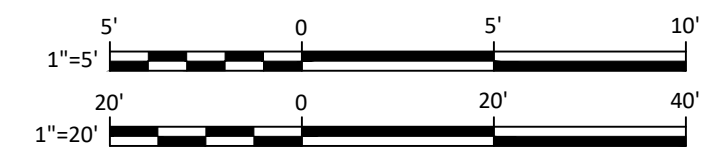

IT IS A VIOLATION OF THE NEW YORK STATE EDUCATION LAW, ARTICLE 145 §7209 SPECIAL PROVISIONS, FOR ANY PERSON, UNLESS THEY ARE ACTING UNDER THE DIRECTION OF A LICENSED PROFESSIONAL ENGINEER, ARCHITECT, LANDSCAPE ARCHITECT, OR LAND SURVEYOR, TO ALTER AN ITEM IN ANY WAY. IF AN ITEM BEARING THE STAMP OF A LICENSED PROFESSIONAL IS ALTERED, THE ALTERING PROFESSIONAL SHALL STAMP THE DOCUMENT AND INCLUDE THE NOTATION "ALTERED BY" FOLLOWED BY THEIR SIGNATURE, THE DATE OF SUCH ALTERATION, AND A SPECIFIC DESCRIPTION OF THE ALTERATION.

REVISIONS

CITY OF ROME
ENVIRONMENTAL RESTORATION PROGRAM
701 LAWRENCE STREET
ONEIDA COUNTY, NEW YORK

SECTIONS

CITY OF ROME

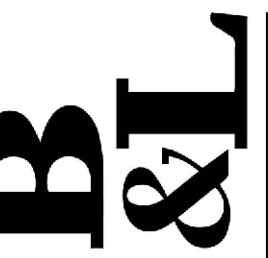

Barton & Loguidice, D.P.C.

10 Airline Drive
Suite 200
Albany, NY
12205



Date
SEPTEMBER 2021

Scale
AS SHOWN

Sheet Number
C501

Project Number
245.005.016

Plotted: Sep 22, 2021 - 8:52AM
 Z:\BL-Vault\02\8217AD2-1C71-4823-8927-9905C054147\0_2364000-2364999\2364086\1\245005_C501_Sections (ID 2364086).dwg
 Checked by INITIALS Drawn by WBG Designed by AZ In charge of SDN

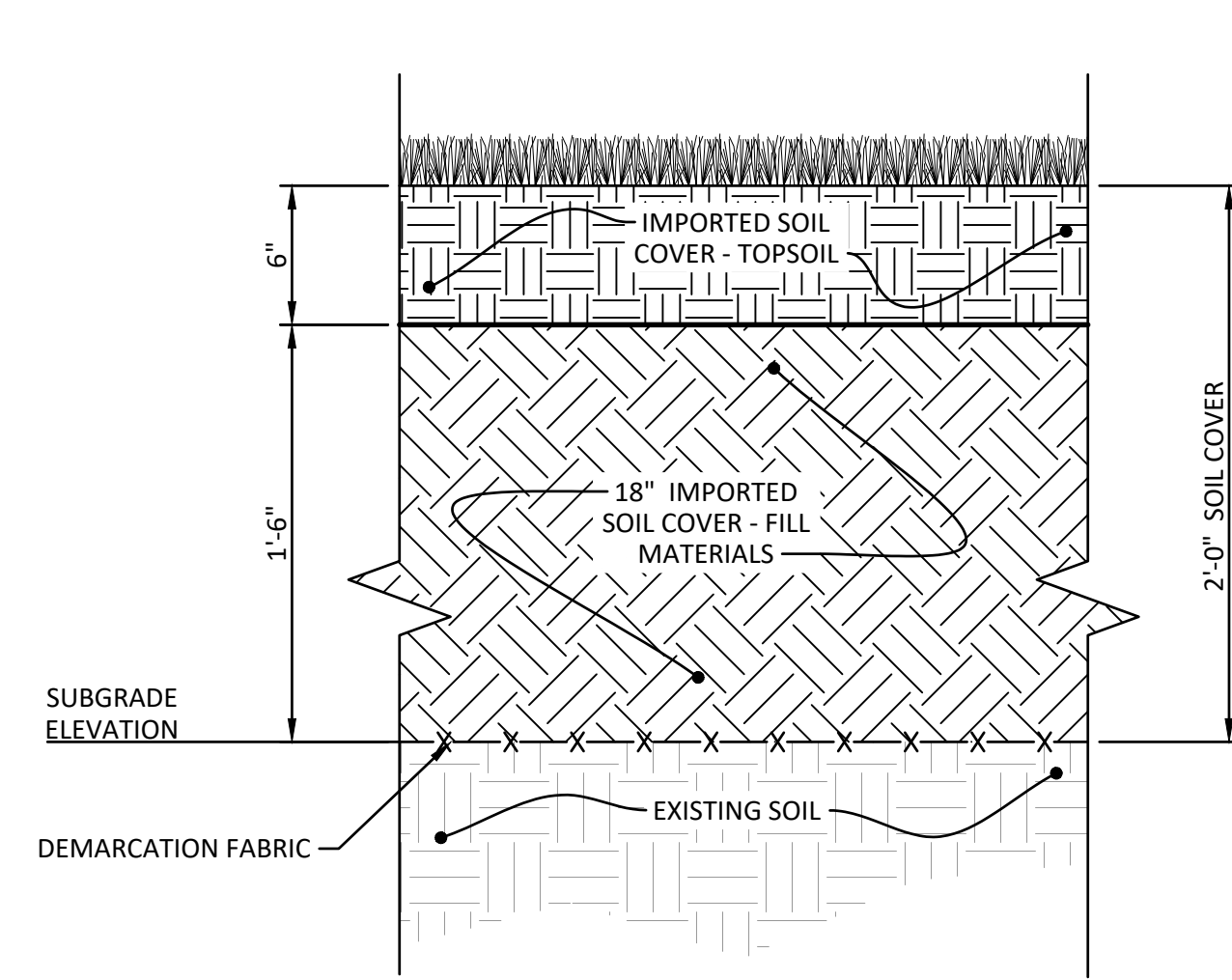

1 SOIL COVER DETAIL
SCALE: 1-1/2" = 1'-0"

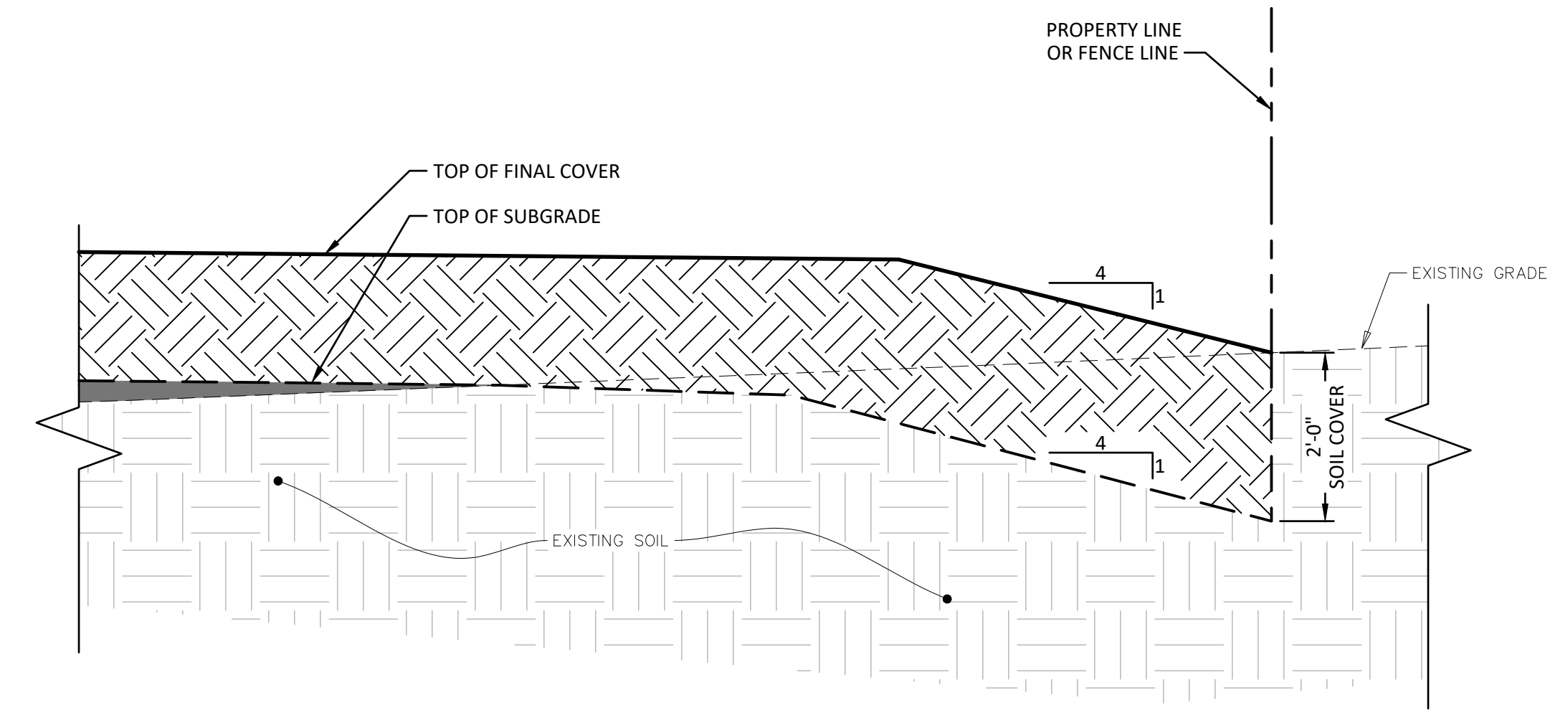

2 SOIL COVER TERMINATION DETAIL
SCALE: 1/2" = 1'-0"

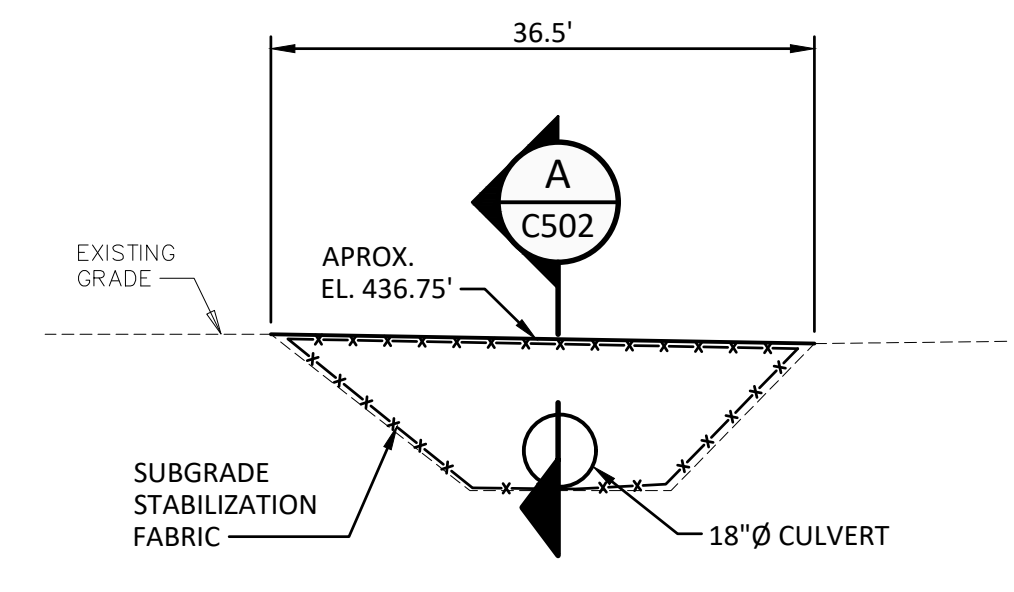

3 ACCESS ROAD DITCH CROSSING
NOT TO SCALE

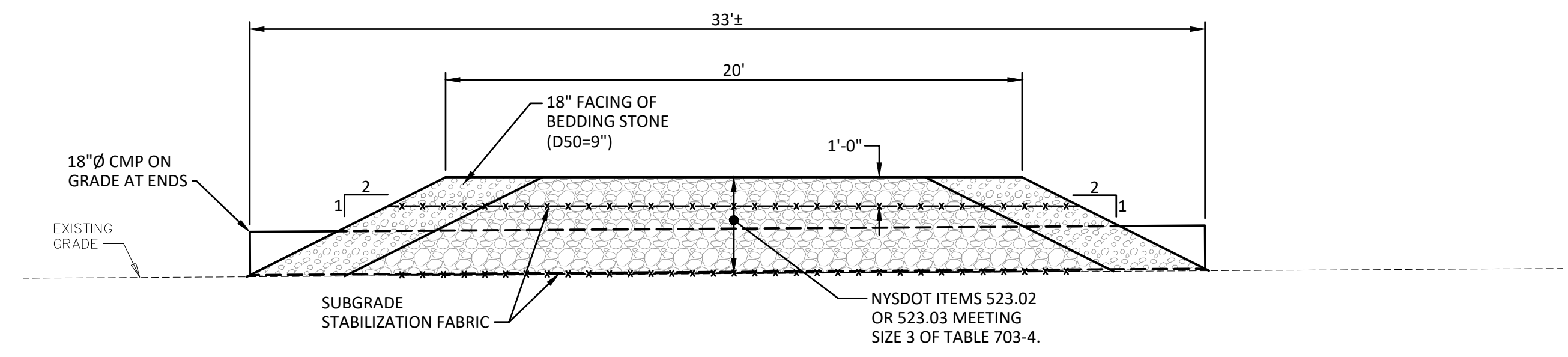

A SECTION
C502 NOT TO SCALE

IT IS A VIOLATION OF THE NEW YORK STATE EDUCATION LAW, ARTICLE 145 §7209 SPECIAL PROVISIONS, FOR ANY PERSON, UNLESS THEY ARE ACTING UNDER THE DIRECTION OF A LICENSED PROFESSIONAL ENGINEER, ARCHITECT, LANDSCAPE ARCHITECT, OR LAND SURVEYOR, TO ALTER AN ITEM IN ANY WAY. IF AN ITEM BEARING THE STAMP OF A LICENSED PROFESSIONAL IS ALTERED, THE ALTERING PROFESSIONAL SHALL STAMP THE DOCUMENT AND INCLUDE THE NOTATION "ALTERED BY" FOLLOWED BY THEIR SIGNATURE, THE DATE OF SUCH ALTERATION, AND A SPECIFIC DESCRIPTION OF THE ALTERATION.

REVISIONS	

CITY OF ROME
ENVIRONMENTAL RESTORATION PROGRAM
701 LAWRENCE STREET
COVER SYSTEM DETAILS
ONEIDA COUNTY, NEW YORK

B&L
10 Airline Drive
Suite 200
Albany, NY
12205
Barton & Loguidice, D.P.C.

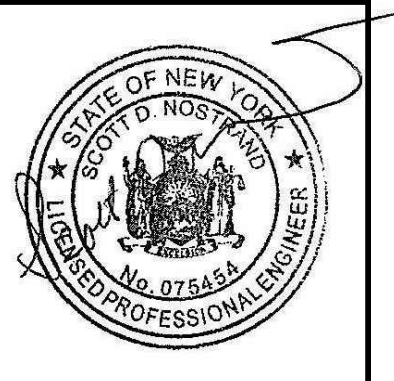

Date: SEPTEMBER 2021
Scale: AS SHOWN
Sheet Number: **C502**
Project Number: 245.005.016

Plotted: Sep 22, 2021 - 8:52AM
Z:\BL-Vault\102\18217AD2-1C71-4823-8927-9905C-054147\0_2364000-2364999\2364087\1\245005_C502_Cover_System_Details (ID 2364087).dwg
Checked by: INITIALS
Drawn by: WBG
Designed by: AZ
In charge of: SDN

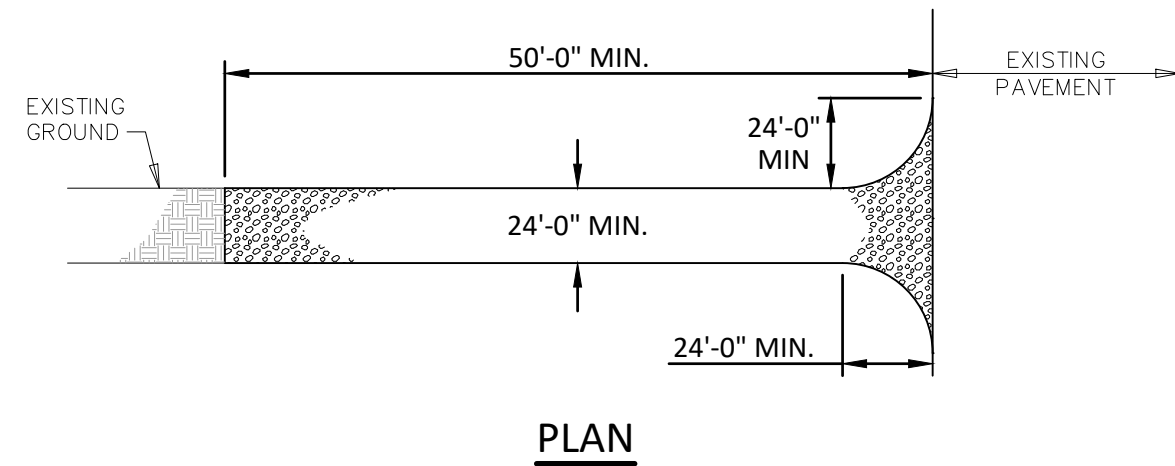
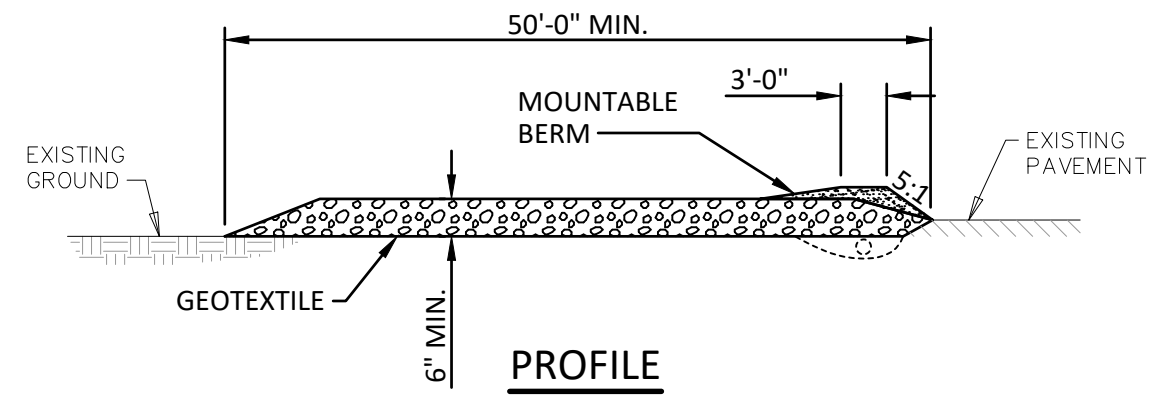

CONSTRUCTION SPECIFICATIONS FOR STABILIZED CONSTRUCTION ENTRANCE

1. GEOTEXTILE SHALL BE PLACED OVER ENTIRE AREA OF STABILIZED CONSTRUCTION ENTRANCE PRIOR TO PLACING STONE. STONE SHALL MEET THE REQUIREMENTS OF NYS DOT ITEM 623.12, CRUSHED STONE #3. ALL SURFACE WATER SHALL BE DIVERTED AWAY FROM CONSTRUCTION ENTRANCE. A MOUNTABLE BERM WITH 5:1 SLOPE IS REQUIRED.
2. THE ENTRANCE WILL BE MAINTAINED IN A CONDITION WHICH WILL PREVENT TRACKING OR FLOWING OF SEDIMENT ONTO PUBLIC RIGHTS OF WAY. ALL SEDIMENT SPILLED, DROPPED, WASHED, OR TRACKED ONTO PUBLIC RIGHTS OF WAY MUST BE REMOVED IMMEDIATELY.
3. WHEN WASHING IS REQUIRED, IT SHALL BE DONE ON AN AREA WITH STONE AND WHICH DRAINS INTO AN APPROVED SEDIMENT TRAPPING DEVICE.
4. PERIODIC INSPECTION AND NEEDED MAINTENANCE SHALL BE DONE REGULARLY AND FOLLOWING EACH RAINFALL.

4 STABILIZED CONSTRUCTION ENTRANCE DETAIL
NOT TO SCALE

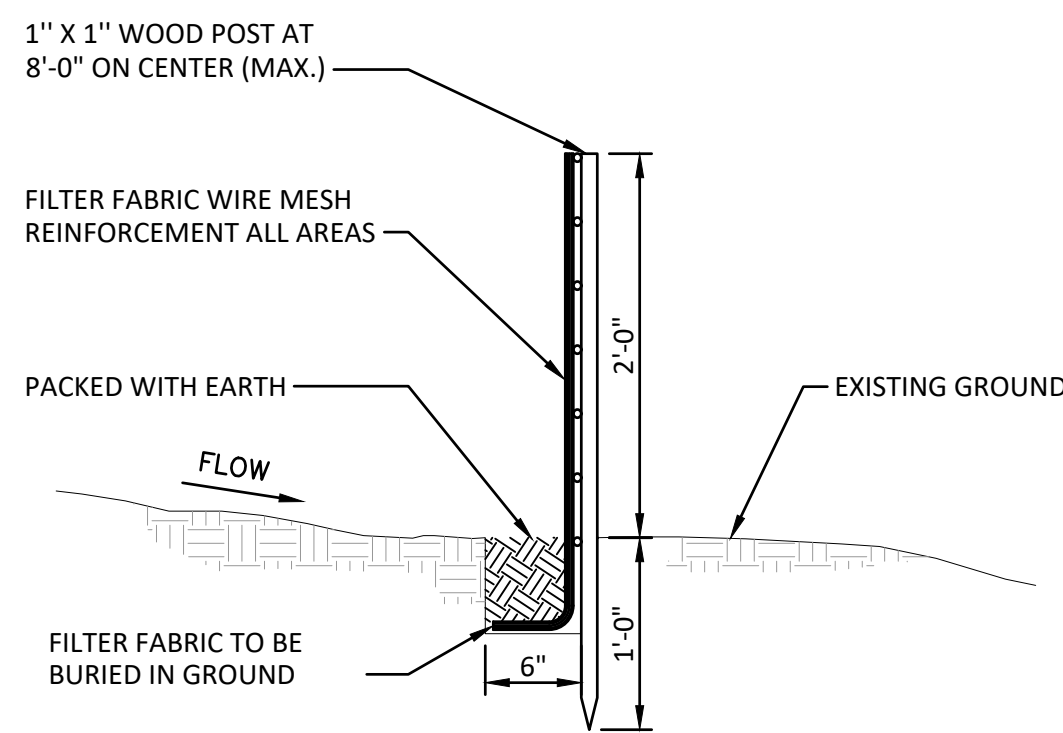

NOTES:

1. WOVEN WIRE FENCE TO BE FASTENED SECURELY TO FENCE POSTS WITH WIRE TIES OR STAPLES.
2. FILTER CLOTH TO BE FASTENED SECURELY TO WOVEN WIRE FENCE WITH TIES SPACED EVERY 24" AT TOP AND MID SECTION.
3. WHEN TWO SECTIONS OF FILTER CLOTH ADJOIN EACH OTHER THEY SHALL BE OVER- LAPPED BY SIX INCHES AND FOLDED. FILTER CLOTH SHALL BE MIRAFI 100X OR APPROVED EQUIVALENT.
4. MAINTENANCE SHALL BE PERFORMED DAILY AND MATERIAL REMOVED WHEN REQUIRED.

5 SILT FENCE FOR TEMPORARY EROSION CONTROL
SCALE: 1" = 1'-0"

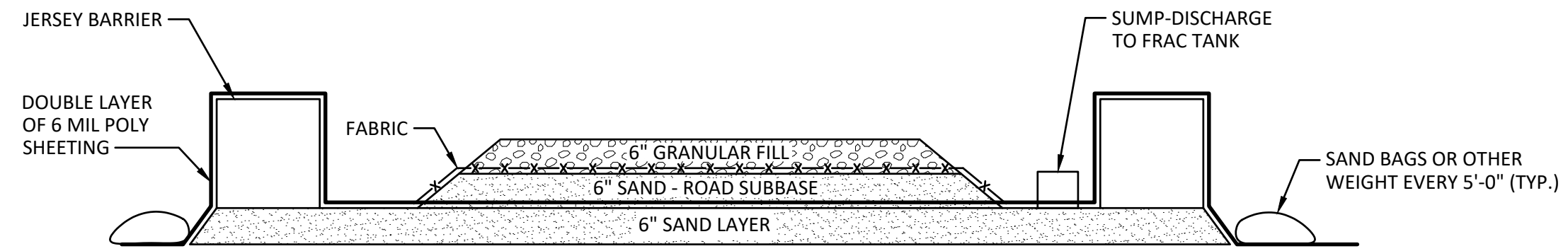

NOTE:
DECONTAMINATION PAD IS SHOWN FOR SCHEMATIC REPRESENTATION. CONTRACTOR SHALL PROPOSE SIZE AND ARRANGEMENT OF DECONTAMINATION PAD IN EXCAVATION AND STAGING PLAN.

B SECTION
C503 NOT TO SCALE

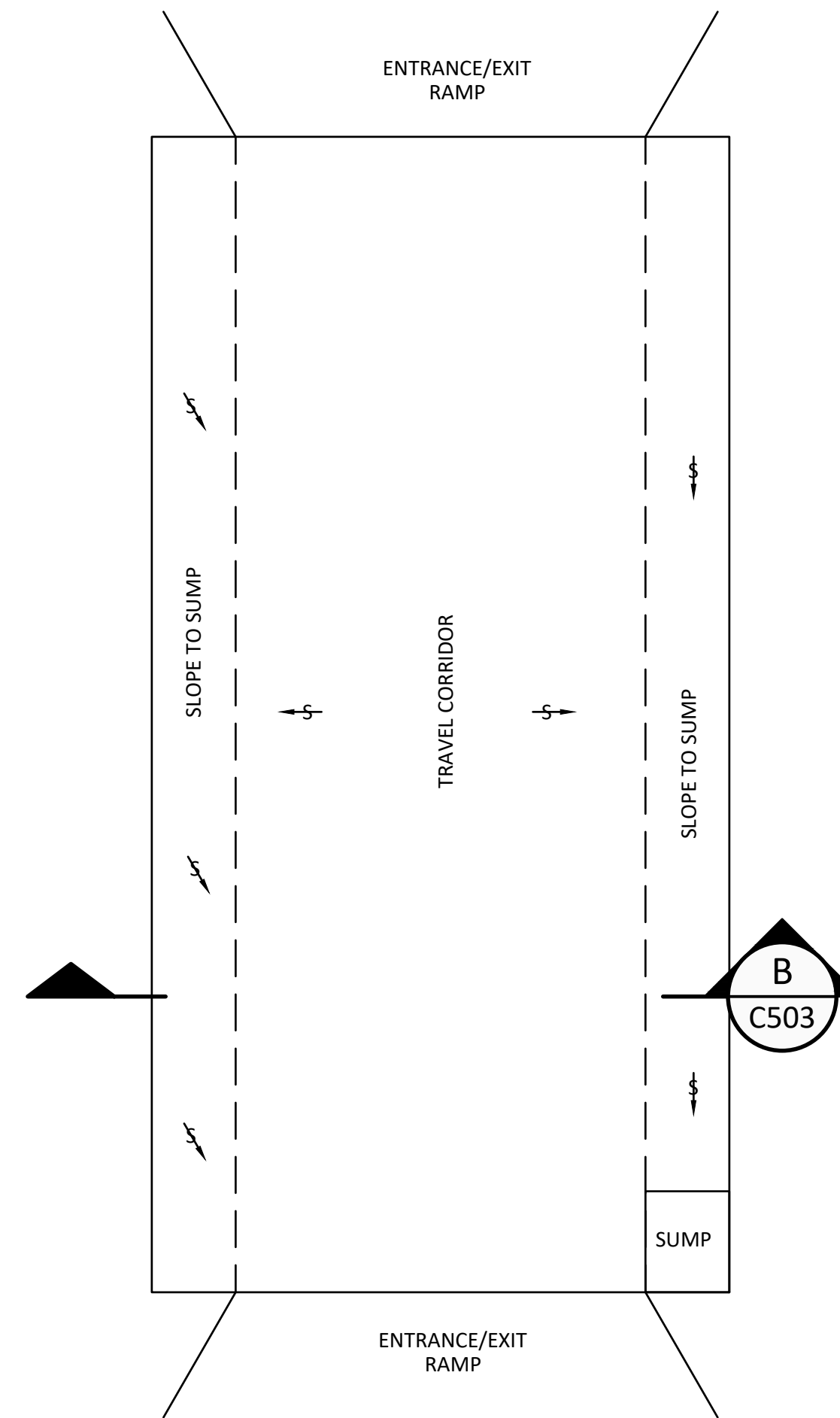

NOTE:

CONTRACTOR WILL SIZE DECONTAMINATION PAD SUCH THAT ALL CONSTRUCTION TRAFFIC WILL BE COMPLETELY CONTAINED WITHIN THE DECONTAMINATION PAD DURING DECONTAMINATION ACTIVITIES. THE CONTRACTOR WILL BE RESPONSIBLE FOR THE COLLECTION AND DISPOSAL OF ALL FLUIDS GENERATED DURING DECONTAMINATION. ALL WASH WATER WILL BE CONTAINED WITHIN THE DECONTAMINATION PAD AND PUMPED FROM THE SUMP TO A FRAC TANK(S). CONTRACTOR IS RESPONSIBLE FOR TESTING OF WATER BEFORE DISPOSAL. IF CLEAN, WATER CAN BE DISCHARGED TO SURFACE FOLLOWING APPROVAL OF ENGINEER. CONTAMINATED WATER SHALL BE DISPOSED OF AT A REGISTERED WATER TREATMENT FACILITY.

6 DECONTAMINATION PAD
NOT TO SCALE

IT IS A VIOLATION OF THE NEW YORK STATE EDUCATION LAW, ARTICLE 145 § 7209 SPECIAL PROVISIONS, FOR ANY PERSON, UNLESS THEY ARE ACTING UNDER THE DIRECTION OF A LICENSED PROFESSIONAL ENGINEER, ARCHITECT, LANDSCAPE ARCHITECT, OR LAND SURVEYOR, TO ALTER AN ITEM IN ANY WAY. IF AN ITEM BEARING THE STAMP OF A LICENSED PROFESSIONAL IS ALTERED, THE ALTERING PROFESSIONAL SHALL STAMP THE DOCUMENT AND INCLUDE THE NOTATION "ALTERED BY" FOLLOWED BY THEIR SIGNATURE, THE DATE OF SUCH ALTERATION, AND A SPECIFIC DESCRIPTION OF THE ALTERATION.

REVISIONS

CITY OF ROME
ENVIRONMENTAL RESTORATION PROGRAM
701 LAWRENCE STREET
ONEIDA COUNTY, NEW YORK
CITY OF ROME

B&L
10 Airline Drive
Suite 200
Albany, NY
12205
Barton & Loguidice, D.P.C.



Date
SEPTEMBER 2021
Scale
AS SHOWN
Sheet Number
C503
Project Number
245.005.016

Plotted: Sep 22, 2021 - 8:52AM
Z:\BL-Vault\ID2\18217AD2-1C71-4823-8927-9905C054147\0_2364000-2364000-2364000\245005_C503 Erosion and Sediment Control Details (10_2364000).dwg
Checked by WBG
Designed by AZ
In charge of SDN

Appendix A
Record of Decision

RECORD OF DECISION

701 Lawrence Street
Operable Unit Number 01: Intersection of Luquer and
Lawrence Streets
Environmental Restoration Project
Rome, Oneida County
Site No. E633063
February 2017

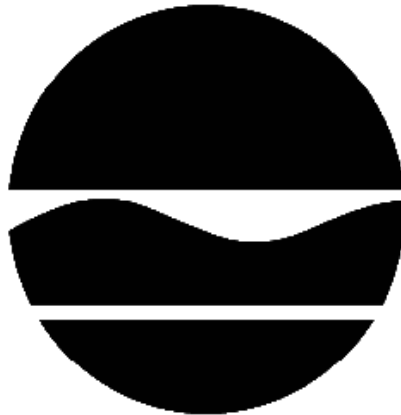

Prepared by
Division of Environmental Remediation
New York State Department of Environmental Conservation

DECLARATION STATEMENT - RECORD OF DECISION

701 Lawrence Street
Operable Unit Number: 01
Environmental Restoration Project
Rome, Oneida County
Site No. E633063
February 2017

Statement of Purpose and Basis

This document presents the remedy for Operable Unit Number: 01: Intersection of Luquer and Lawrence Streets of the 701 Lawrence Street site, an environmental restoration site. The remedial program was chosen in accordance with the New York State Environmental Conservation Law and Title 6 of the Official Compilation of Codes, Rules and Regulations of the State of New York (6 NYCRR) Part 375.

This decision is based on the Administrative Record of the New York State Department of Environmental Conservation (the Department) for Operable Unit Number: 01 of the 701 Lawrence Street site and the public's input to the proposed remedy presented by the Department. A listing of the documents included as a part of the Administrative Record is included in Appendix B of the ROD.

Description of Selected Remedy

The elements of the selected remedy are as follows:

1. Remedial Design

A remedial design program will be implemented to provide the details necessary for the construction, operation, optimization, maintenance, and monitoring of the remedial program. Green remediation principles and techniques will be implemented to the extent feasible in the design, implementation, and site management of the remedy as per DER-31. The major green remediation components are as follows;

- Considering the environmental impacts of treatment technologies and remedy stewardship over the long term;
- Reducing direct and indirect greenhouse gases and other emissions;
- Increasing energy efficiency and minimizing use of non-renewable energy;
- Conserving and efficiently managing resources and materials;
- Reducing waste, increasing recycling and increasing reuse of materials which would otherwise be considered a waste;
- Maximizing habitat value and creating habitat when possible;
- Fostering green and healthy communities and working landscapes which balance

- ecological, economic and social goals; and
- Integrating the remedy with the end use where possible and encouraging green and sustainable re-development.

2. Site Cover

A site cover (Figure 5), consisting of two feet of imported soil will be required to allow for restricted-residential use of the site. The cover will consist either of the structures such as buildings, pavement, sidewalks comprising the site development or a soil cover in areas where the upper two feet of exposed surface soil will exceed the applicable soil cleanup objectives (SCOs). Where a soil cover is required, it will be a minimum of two feet of soil, meeting the SCOs for cover material as set forth in 6 NYCRR Part 375-6.7(d) for restricted-residential use. The soil cover will be placed over a demarcation layer, with the upper six inches of the soil of sufficient quality to maintain a vegetation layer. Any fill material brought to the site will meet the requirements for the identified site use as set forth in 6 NYCRR Part 375-6.7(d).

3. Institutional Control

Imposition of an institutional control in the form of an environmental easement for the controlled property that:

- requires the remedial party or site owner to complete and submit to the Department a periodic certification of institutional and engineering controls in accordance with Part 375-1.8 (h)(3);
- allows the use and development of the controlled property for restricted-residential, commercial, and industrial uses as defined by Part 375-1.8(g), although land use is subject to local zoning laws;
- restricts the use of groundwater as a source of potable or process water, without necessary water quality treatment as determined by the NYSDOH or Oneida County DOH; and
- requires compliance with the Department approved Site Management Plan.

4. Site Management Plan

A Site Management Plan is required, which includes the following:

- a. An Institutional and Engineering Control Plan that identifies all use restrictions and engineering controls for the site and details the steps and media-specific requirements necessary to ensure the following institutional and/or engineering controls remain in place and effective:

Institutional Controls: The Environmental Easement discussed in Paragraph 3 above.

Engineering Controls: The cover system discussed in Paragraph 2 above.

This plan includes, but may not be limited to:

- an Excavation Plan which details the provisions for management of future excavations on

- the controlled property;
 - a provision, should redevelopment occur, to ensure no soil exceeding protection of groundwater concentrations will remain below storm water retention basin or infiltration structures;
 - descriptions of the provisions of the environmental easement including any land use and groundwater use restrictions;
 - provisions for the management and inspection of the soil cover;
 - a provision for evaluation of the potential for soil vapor intrusion into any future buildings developed on the site, including provision for implementing actions recommended to address exposures related to soil vapor intrusion.
 - maintaining site access controls and Department notification;
 - the steps necessary for the periodic reviews and certification of the institutional controls.
- b. a Monitoring Plan to assess the performance and effectiveness of the remedy. The plan includes, but may not be limited to:
- a schedule of monitoring and frequency of submittals to the Department;
 - monitoring for vapor intrusion for any new buildings developed on the site, as may be required by the Institutional and Engineering Control Plan discussed above.

New York State Department of Health Acceptance

The New York State Department of Health (NYSDOH) concurs that the remedy for this site is protective of human health.

Declaration

The selected remedy is protective of human health and the environment, complies with State and Federal requirements that are legally applicable or relevant and appropriate to the remedial action to the extent practicable, and is cost effective. This remedy utilizes permanent solutions and alternative treatment or resource recovery technologies, to the maximum extent practicable, and satisfies the preference for remedies that reduce toxicity, mobility, or volume as a principal element.

February 15, 2017

Date



Robert W. Schick, P.E., Director
Division of Environmental Remediation

RECORD OF DECISION

701 Lawrence Street
Operable Unit Number: 01
Rome, Oneida County
Site No. E633063
February 2017

SECTION 1: SUMMARY AND PURPOSE

The New York State Department of Environmental Conservation (the Department), in consultation with the New York State Department of Health (NYSDOH), has selected a remedy for the above referenced site. The disposal of contaminants at the site has resulted in threats to public health and the environment that would be addressed by the remedy. The disposal or release of contaminants at this site, as more fully described in this document, has contaminated various environmental media. Contaminants include hazardous waste and/or petroleum. The remedy is intended to attain the remedial action objectives identified for this site for the protection of public health and the environment. This Record of Decision (ROD) identifies the selected remedy, summarizes the other alternatives considered, and discusses the reasons for selecting the remedy.

The 1996 Clean Water/ Clean Air Bond Act provides funding to municipalities for the investigation and cleanup of brownfields. Brownfields are abandoned, idled, or under-used properties where redevelopment is complicated by real or perceived environmental contamination. They typically are former industrial or commercial properties where operations may have resulted in environmental contamination. Brownfields often pose not only environmental, but legal and financial burdens on communities. Under the Environmental Restoration Program, the state provides grants to municipalities to reimburse up to 90 percent of eligible costs for site investigation and remediation activities. Once remediated, the property can then be reused.

The Department has issued this document in accordance with the requirements of New York State Environmental Conservation Law and 6 NYCRR Part 375. This document is a summary of the information that can be found in the site-related reports and documents.

SECTION 2: CITIZEN PARTICIPATION

The Department seeks input from the community on all remedies. A public comment period was held, during which the public was encouraged to submit comment on the proposed remedy. All comments on the remedy received during the comment period were considered by the Department in selecting a remedy for the site. Site-related reports and documents were made available for review by the public at the following document repositories:

Jervis Public Library
613 North Washington Street
Rome, NY 13440
Phone: 315-336-4570

City of Rome
Attn: Diana Samuels
198 North Washington Street
Rome, NY 13440
Phone: 315-339-7646

A public meeting on January 19, 2017 was also conducted. At the meeting, the findings of the remedial investigation (RI) and the alternatives analyses (AA) were presented along with a summary of the proposed remedy. After the presentation, a question-and-answer period was held, during which verbal or written comments were accepted on the proposed remedy.

Comments on the remedy received during the comment period are summarized and addressed in the responsiveness summary section of the ROD.

Receive Site Citizen Participation Information By Email

Please note that the Department's Division of Environmental Remediation (DER) is "going paperless" relative to citizen participation information. The ultimate goal is to distribute citizen participation information about contaminated sites electronically by way of county email listservs. Information will be distributed for all sites that are being investigated and cleaned up in a particular county under the State Superfund Program, Environmental Restoration Program, Brownfield Cleanup Program, Voluntary Cleanup Program, and Resource Conservation and Recovery Act Program. We encourage the public to sign up for one or more county listservs at <http://www.dec.ny.gov/chemical/61092.html>

SECTION 3: SITE DESCRIPTION AND HISTORY

Location: The site is comprised of two parcels divided by the New York State Barge Canal. The parcel to the north of the Barge Canal is located at the intersection of Luquer and Lawrence Streets and comprises 1.85 acres. The parcel to the south of the Barge Canal is located at the intersection of Martin and Lawrence Streets and comprises 1.4 acres.

Site Features: Both parcels are currently vacant with no structures. Forming the southern boundary of the northern parcel (Luquer and Lawrence Street) is the off-site Canalway Trail maintained by the New York State Canal Corporation. The Canalway Trail is a paved walking path with metal railings to prevent entry into the canal and a chain link fence along the southern boundary of the Luquer and Lawrence Streets parcel to prevent access to the site. There are no structures on the Canalway Trail near the site. The Canalway Trail is shown on the attached aerial photograph.

Current Zoning/Use(s): The two properties are zoned for industrial use. The surrounding parcels are also zoned industrial/commercial and include vacant lots, lands owned by the NYS Canal Corporation and an auto repair facility. Some residences are located about 500 north of the site.

Past Use of the Site: Both properties were historically connected by the former Lawrence Street bridge. Prior uses of the site that have led to site contamination were the former bulk fuel and distribution operations as well as several spills that were reported during the property's operational period as a Major Oil Storage Facility.

Operable Units (OUs): The site consists of two OUs. OU-1, the subject of this PRAP is the parcel north of the NYS Barge Canal at the intersection of Luquer and Lawrence Streets. OU-2 is the parcel located south of the Barge Canal at the intersection of Martin and Lawrence Streets. The word "site" in the remainder of this document refers to OU-1 alone.

Site Geology and Hydrogeology: The northern site (OU-1) consists of shallow fill material consisting of gravel and asphalt (ranging from 2 inches to 3 feet in depth), increasing with thickness towards the eastern portion of the site. Below the gravel fill, silt and clay extend from 1-14 feet below grade which is then underlain by sand and gravels to a depth of 22 feet below grade. Groundwater was found between 2.5 and 12.5 feet below grade and flows to the south towards the barge canal. Bedrock was not encountered during the investigation. Further investigation is required at the southern parcel (OU-2) to define the overburden geology and groundwater.

A site location map is attached as Figure 1, the property boundary is the site boundary as shown on Figure 2.

Operable Unit (OU) Number 01 is the subject of this document.

A Record of Decision will be issued for OU 02 in the future.

A site location map is attached as Figure 1.

SECTION 4: LAND USE AND PHYSICAL SETTING

The Department may consider the current, intended, and reasonably anticipated future land use of the site and its surroundings when evaluating a remedy for soil remediation. For this site, alternatives (or an alternative) that restrict(s) the use of the site to restricted-residential use (which allows for commercial use and industrial use) as described in Part 375-1.8(g) were/was evaluated in addition to an alternative which would allow for unrestricted use of the site.

A comparison of the results of the RI to the appropriate standards, criteria and guidance values (SCGs) for the identified land use and the unrestricted use SCGs for the site contaminants is included in the Tables for the media being evaluated in Exhibit A.

SECTION 5: ENFORCEMENT STATUS

Potentially Responsible Parties (PRPs) are those who may be legally liable for contamination at a

site. This may include past or present owners and operators, waste generators, and haulers.

No PRPs have been documented to date.

The City of Rome entered into a State Assistance Contract with the Department in 2007. The contract obligates the City to investigate the site and implement a remedy.

Since no viable PRPs have been identified, there are currently no ongoing enforcement actions. However, legal action may be initiated at a future date by the state to recover state response costs should PRPs be identified. City of Rome will assist the state in its efforts by providing all information to the state which identifies PRPs. City of Rome will also not enter into any agreement regarding response costs without the approval of the Department.

SECTION 6: SITE CONTAMINATION

6.1: Summary of the Remedial Investigation

A Remedial Investigation (RI) has been conducted. The purpose of the RI was to define the nature and extent of any contamination resulting from previous activities at the site. The field activities and findings of the investigation are described in the RI Report.

The following general activities are conducted during an RI:

- Research of historical information,
- Geophysical survey to determine the lateral extent of wastes,
- Test pits, soil borings, and monitoring well installations,
- Sampling of waste, surface and subsurface soils, groundwater, and soil vapor,
- Sampling of surface water and sediment,
- Ecological and Human Health Exposure Assessments.

The analytical data collected on this site includes data for:

- groundwater
- soil
- sediment

6.1.1: Standards, Criteria, and Guidance (SCGs)

The remedy must conform to promulgated standards and criteria that are directly applicable or that

are relevant and appropriate. The selection of a remedy must also take into consideration guidance, as appropriate. Standards, Criteria and Guidance are hereafter called SCGs.

To determine whether the contaminants identified in various media are present at levels of concern, the data from the RI were compared to media-specific SCGs. The Department has developed SCGs for groundwater, surface water, sediments, and soil. The NYSDOH has developed SCGs for drinking water and soil vapor intrusion. The tables found in Exhibit A list the applicable SCGs in the footnotes. For a full listing of all SCGs see: <http://www.dec.ny.gov/regulations/61794.html>

6.1.2: RI Results

The data have identified contaminants of concern. A "contaminant of concern" is a contaminant that is sufficiently present in frequency and concentration in the environment to require evaluation for remedial action. Not all contaminants identified on the property are contaminants of concern. The nature and extent of contamination and environmental media requiring action are summarized in Exhibit A. Additionally, the RI Report contains a full discussion of the data. The contaminant(s) of concern identified for this Operable Unit at this site are:

Chromium
Nickel
Lead
Zinc
Copper
Acetone
Xylene
Ethylbenzene
Tentatively identified compounds (TICs) associated with weathered petroleum products

As illustrated in Exhibit A, the contaminant(s) of concern exceed the applicable SCGs for:

- soil

6.2: Interim Remedial Measures

An interim remedial measure (IRM) is conducted at a site when a source of contamination or exposure pathway can be effectively addressed before issuance of the Record of Decision.

The following IRM(s) has/have been completed at this site based on conditions observed during the RI.

Source Removal Intersection of Luquer and Lawrence Streets

An IRM was completed which included the removal of waste materials, a building, above-ground and underground tanks and soils. The IRM Completion Report was approved in March 2012.

The IRM was conducted in three phases. The first phase involved the removal of asbestos and lead paint from the former on-site building and was performed in January-February 2009. The second phase consisted of removing four 275 gallon above-ground storage tanks, a 4000 gallon mobile fueling tank, fourteen 55 gallon drums of petroleum products and miscellaneous wastes, followed by demolition of the building. The building was approximately 7,450 square feet in size and built of brick, concrete and wood. This work was accomplished in June-August 2009. The third phase included the removal of two on-site underground storage tanks (a 1000 gallon gasoline tank and a 2000 gallon fuel oil tank), a stormwater oil/water separator unit which was located off-site to the south on Canal Corporation property, and underground piping. These removal actions also included removal and off-site disposal of 730 tons of contaminated soils in the immediate area of the tanks and piping, followed by confirmatory soil sampling. The work was done from October-November 2009.

Confirmation soil samples taken after these actions found acetone ranging from non-detectable (ND) up to 0.081 parts per million (ppm), xylene (ND - 1 ppm) and ethylbenzene (ND - 1.7 ppm) and metals such as chromium (13.5 – 22 ppm) and nickel (ND - 38 ppm) were slightly above the unrestricted soil cleanup objectives (SCOs) but below the residential soil cleanup objectives (SCOs). No other constituents were detected above the unrestricted use SCO. However, several tentatively identified compounds (TICs) were noted in the subsurface soil, and visual and olfactory observation of 'weathered petroleum' were observed in the subsurface soils

Confirmation samples are included in Exhibit A.

6.3: Summary of Environmental Assessment

This section summarizes the assessment of existing and potential future environmental impacts presented by the site. Environmental impacts may include existing and potential future exposure pathways to fish and wildlife receptors, wetlands, groundwater resources, and surface water.

Based upon the resources and pathways identified and the toxicity of the contaminants of ecological concern at this site, a Fish and Wildlife Resources Impact Analysis (FWRIA) was deemed not necessary for OU 01.

Nature and Extent of Contamination: Environmental concerns at OU-1 result from the site's former use as Major Oil Storage Facility. Several petroleum spills have been documented at the site. Groundwater sampling results for the period of March 1992 through July 1995 revealed that contaminants representative of lubrication oil, gasoline, kerosene, and fuel oil were detected in the on-site groundwater. Monitoring wells installed as part of the site assessment were reportedly abandoned in 1997. Soil and groundwater were analyzed for volatile organic compounds (VOCs) and semi-volatile organic compounds (SVOCS), metals, and PCB/pesticides.

Surface Soil - On-site shallow soils were sampled from 4-10 inches below ground surface. The near-surface material was very gravelly, which resulted in samples being taken slightly deeper than the recommended depth of 0-2 inches below ground surface for purposes of evaluating potential exposures. The on-site soil contained metals including chromium at a maximum concentration of 23 ppm, lead at a maximum of 244 ppm, zinc at a maximum of 289 ppm and copper at a maximum of 114 ppm. These metals exceed the unrestricted use SCOs but not the restricted residential SCOs. Surface soils had no VOCs, SVOCs, PCBs or other metals which exceeded applicable Part 375 SCOs although TICs for both VOCs and SVOCs were detected. TICs ranged from non-detectable (ND) to 0.277 ppm for VOCs and ND to 7.60 ppm for SVOCs.

Subsurface Soils - Subsurface soils were collected to depths of up to 22 feet. Most samples were collected from 4 to 12 feet based on field screening and visual observation. Soils contained the metals chromium at a maximum concentration of 20 ppm, and nickel at a maximum of 40 ppm and VOCs (acetone 0.088 ppm, ethyl benzene 6.2 ppm and xylene 6 ppm), which exceed the unrestricted SCOs but not the residential SCOs. Although not reflected in the sample results, petroleum contamination in the form of stained soils and odors was apparent in soils observed during test pitting both on and off-site. Soils had no other VOCs, SVOCs, PCBs or other metals which exceeded applicable Part 375 SCOs although TICs for both VOCs and SVOCs were detected. TICs ranged from non-detectable (ND) to 210 ppm for VOCs and ND to 483 ppm for SVOCs.

Off-site, prior to its construction, the area of the Canalway trail was investigated with soil borings and sub-surface soils samples which were analyzed for VOCs, SVOCs and metals. Sample results showed exceedances of unrestricted SCOs for VOCs (acetone at 0.26 ppm) and metals (chromium at 20 ppm and nickel at 30 ppm) and SVOCs in the upper one foot of soils. In the subsurface soil the total detectable VOC concentrations (including TICs) ranged from ND to 1.4 ppm. Total detectable SVOC concentrations (including TICs) in the sub-surface soils ranged from ND to 163 ppm. These levels did not exceed the SCOs for residential use, which includes active recreational use as the Canalway Trail. Approximately one foot of stone aggregate was placed along the path of the trail prior to paving.

Groundwater - Groundwater was tested for VOCs, SVOCs, PCBs and metals, the only exceedances were iron, manganese, and sodium, although these constituents are not believed to be related to past site operations, but are naturally occurring. Groundwater flow is to the south toward the barge canal. There were no off-site groundwater samples collected.

Soil vapor - The evaluation of the potential for soil vapor intrusion resulting from the presence of site related soil and/or groundwater contamination was not evaluated by quantitative sampling. Field readings with a photoionization detector recorded VOC readings in the range of 3.5 to 1,091 ppm in the on-site soil borings and 1.5 to 330 ppm in the off-site borings. Since there are no structures on-site or on the adjacent Canalway Trail and soil and groundwater sampling showed only minimal VOC impacts, soil vapor was not further evaluated.

Special Resources Impacted/Threatened: The New York State Barge Canal is located between the two parcels. Releases from the sites have the capability of impacting this resource although no

observations of contamination have been documented. Further investigation of possible impacts to the canal are anticipated as part of the OU-2 investigation.

6.4: Summary of Human Exposure Pathways

This human exposure assessment identifies ways in which people may be exposed to site-related contaminants. Chemicals can enter the body through three major pathways (breathing, touching or swallowing). This is referred to as *exposure*.

Persons who dig below the ground surface may come into contact with contaminants in subsurface soil. Contaminated groundwater at the site is not used for drinking purposes and the area is served by a public water supply that obtains water from a different source not affected by this contamination. Volatile organic compounds in the groundwater may move into the soil vapor (air spaces within the soil), which in turn may move into overlying buildings and affect the indoor air quality. This process, which is similar to the movement of radon gas from the subsurface into the indoor air of buildings, is referred to as soil vapor intrusion. Because the site is vacant, the inhalation of site-related contaminants due to soil vapor intrusion does not represent a current concern. However, the potential exists for the inhalation of site contaminants due to soil vapor intrusion for any future on-site development. Sampling indicates soil vapor intrusion is not a concern for off-site buildings.

6.5: Summary of the Remediation Objectives

The objectives for the remedial program have been established through the remedy selection process stated in 6 NYCRR Part 375. The goal for the remedial program is to restore the site to pre-disposal conditions to the extent feasible. At a minimum, the remedy shall eliminate or mitigate all significant threats to public health and the environment presented by the contamination identified at the site through the proper application of scientific and engineering principles.

The remedial action objectives for this site are:

Groundwater

RAOs for Public Health Protection

- Prevent ingestion of groundwater with contaminant levels exceeding drinking water standards.

RAOs for Environmental Protection

- Remove the source of ground or surface water contamination.

Soil

RAOs for Public Health Protection

- Prevent ingestion/direct contact with contaminated soil.

RAOs for Environmental Protection

- Prevent migration of contaminants that would result in groundwater or surface water contamination.

Soil Vapor

RAOs for Public Health Protection

- Mitigate impacts to public health resulting from existing, or the potential for, soil vapor intrusion into buildings at a site.

SECTION 7: SUMMARY OF THE SELECTED REMEDY

To be selected the remedy must be protective of human health and the environment, be cost-effective, comply with other statutory requirements, and utilize permanent solutions, alternative technologies or resource recovery technologies to the maximum extent practicable. The remedy must also attain the remedial action objectives identified for the site, which are presented in Section 6.5. Potential remedial alternatives for the Site were identified, screened and evaluated in the alternatives analysis (AA) report.

A summary of the remedial alternatives that were considered for this site is presented in Exhibit B. Cost information is presented in the form of present worth, which represents the amount of money invested in the current year that would be sufficient to cover all present and future costs associated with the alternative. This enables the costs of remedial alternatives to be compared on a common basis. As a convention, a time frame of 30 years is used to evaluate present worth costs for alternatives with an indefinite duration. This does not imply that operation, maintenance, or monitoring would cease after 30 years if remediation goals are not achieved. A summary of the Remedial Alternatives Costs is included as Exhibit C.

The basis for the Department's remedy is set forth at Exhibit D.

The selected remedy is referred to as the Soil Cover, Institutional Controls and Site Management remedy.

The estimated present worth cost to implement the remedy is \$205,130. The cost to construct the remedy is estimated to be \$202,130 and the estimated average annual cost is \$3,000.

The elements of the selected remedy are as follows:

1. Remedial Design

A remedial design program will be implemented to provide the details necessary for the construction, operation, optimization, maintenance, and monitoring of the remedial program. Green remediation principles and techniques will be implemented to the extent feasible in the design, implementation, and site management of the remedy as per DER-31. The major green remediation components are as follows;

- Considering the environmental impacts of treatment technologies and remedy stewardship over the long term;
- Reducing direct and indirect greenhouse gases and other emissions;
- Increasing energy efficiency and minimizing use of non-renewable energy;

- Conserving and efficiently managing resources and materials;
- Reducing waste, increasing recycling and increasing reuse of materials which would otherwise be considered a waste;
- Maximizing habitat value and creating habitat when possible;
- Fostering green and healthy communities and working landscapes which balance ecological, economic and social goals; and
- Integrating the remedy with the end use where possible and encouraging green and sustainable re-development.

2. Site Cover

A site cover (Figure 5), consisting of two feet of imported soil will be required to allow for restricted-residential use of the site. The cover will consist either of the structures such as buildings, pavement, sidewalks comprising the site development or a soil cover in areas where the upper two feet of exposed surface soil will exceed the applicable soil cleanup objectives (SCOs). Where a soil cover is required, it will be a minimum of two feet of soil, meeting the SCOs for cover material as set forth in 6 NYCRR Part 375-6.7(d) for restricted-residential use. The soil cover will be placed over a demarcation layer, with the upper six inches of the soil of sufficient quality to maintain a vegetation layer. Any fill material brought to the site will meet the requirements for the identified site use as set forth in 6 NYCRR Part 375-6.7(d).

3. Institutional Control

Imposition of an institutional control in the form of an environmental easement for the controlled property that:

- requires the remedial party or site owner to complete and submit to the Department a periodic certification of institutional and engineering controls in accordance with Part 375-1.8 (h)(3);
- allows the use and development of the controlled property for restricted-residential, commercial, and industrial uses as defined by Part 375-1.8(g), although land use is subject to local zoning laws;
- restricts the use of groundwater as a source of potable or process water, without necessary water quality treatment as determined by the NYSDOH or Oneida County DOH; and
- requires compliance with the Department approved Site Management Plan.

4. Site Management Plan

A Site Management Plan is required, which includes the following:

- a. An Institutional and Engineering Control Plan that identifies all use restrictions and engineering controls for the site and details the steps and media-specific requirements necessary to ensure the following institutional and/or engineering controls remain in place and effective:

Institutional Controls: The Environmental Easement discussed in Paragraph 3 above.
Engineering Controls: The cover system discussed in Paragraph 2 above.

This plan includes, but may not be limited to:

- an Excavation Plan which details the provisions for management of future excavations on the controlled property;
 - a provision, should redevelopment occur, to ensure no soil exceeding protection of groundwater concentrations will remain below storm water retention basin or infiltration structures;
 - descriptions of the provisions of the environmental easement including any land use and groundwater use restrictions;
 - provisions for the management and inspection of the soil cover;
 - a provision for evaluation of the potential for soil vapor intrusion into any future buildings developed on the site, including provision for implementing actions recommended to address exposures related to soil vapor intrusion.
 - maintaining site access controls and Department notification;
 - the steps necessary for the periodic reviews and certification of the institutional controls.
- b. a Monitoring Plan to assess the performance and effectiveness of the remedy. The plan includes, but may not be limited to:
- a schedule of monitoring and frequency of submittals to the Department;
 - monitoring for vapor intrusion for any new buildings developed on the site, as may be required by the Institutional and Engineering Control Plan discussed above.

Exhibit A

Nature and Extent of Contamination

This section describes the findings of the Remedial Investigation for all environmental media that were evaluated. As described in Section 6.1, samples were collected from various environmental media to characterize the nature and extent of contamination.

For each medium for which contamination was identified, a table summarizes the findings of the investigation. The tables present the range of contamination found at the site in the media and compares the data with the applicable SCGs for the site. The contaminants are arranged into four categories: volatile organic compounds (VOCs), semi-volatile organic compounds (SVOCs), polychlorinated biphenyls (PCBs), and inorganics (metals and cyanide). For comparison purposes, the SCGs are provided for each medium that allows for unrestricted use. For soil, if applicable, the Restricted Use SCGs identified in Section 4 and Section 6.1.1 are also presented.

Waste/Source Areas

As described in the RI report, waste/source materials were identified at the site and are impacting groundwater, and soil.

Wastes are defined in 6 NYCRR Part 375-1.2(aw) and include solid, industrial and/or hazardous wastes. Source Areas are defined in 6 NYCRR Part 375(au). Source areas are areas of concern at a site where substantial quantities of contaminants are found which can migrate and release significant levels of contaminants to another environmental medium. Wastes and source areas were identified at the site, including impacts to soil from historic petroleum use at the site. The waste/source areas identified at the site, which included; four 275 gallon above-ground storage tanks, a 4000 gallon mobile fueling tank, two underground storage tanks (a 1000 gallon gasoline tank and a 2000 gallon fuel oil tank), fourteen 55 gallon drums of petroleum products, a storm water oil/water separator and underground piping, were addressed by the IRM described in Section 6.2.

Groundwater

Groundwater samples were collected from overburden monitoring wells. The samples were collected to assess groundwater conditions on-site. The results indicate that some commonly found inorganics were detected in shallow groundwater at the site that were above the respective SCGs.

Table 1 - Groundwater

Detected Constituents	Concentration Range Detected (ppm) ^a	SCG (ppm) ^b	Frequency Exceeding SCG
Inorganics			
Iron	7.73 - 48.3	0.3	6 out of 6
Manganese	1.87 - 6.58	0.3	6 out of 6
Sodium	55 - 151	20	6 out of 6

a - ppm: parts per million, which is equivalent to milligrams per liter, mg/L, in water.

b- SCG: Standard Criteria or Guidance - Ambient Water Quality Standards and Guidance Values (TOGs 1.1.1), 6 NYCRR Part 703, Surface water and Groundwater Quality Standards, and Part 5 of the New York State Sanitary Code (10 NYCRR Part 5).

The inorganic exceedances shown in the above table are not considered to be associated with the site but are considered artifacts due to the urban environment and the high turbidity in the samples. No site-related groundwater contamination of concern was identified during the RI. Therefore, no remedial alternatives are evaluated for groundwater.

Soil

Table 2 – Shallow Soil

Detected Constituents	Concentration Range (ppm) ^a	Unrestricted Use SCO ^b (ppm)	Frequency Exceeding Unrestricted Use SCO	Restricted Residential Use SCO (ppm) ^c	Frequency Exceeding Restricted SCO
Inorganics					
Chromium	3.75-23.5	1 ^d	7 out of 7	110 ^d	0 out of 7
Lead	3.1-244	63	1 out of 7	400	0 out of 7
Zinc	17.6-289	1093	3 out of 7	10,000	0 out of 7
Copper	8.1-114	50	4 out of 7	270	0 out of 7
Organics					
Acetone	ND-0.065	0.05	1 out of 7	100	0 out of 7

a - ppm: parts per million, which is equivalent to milligrams per kilogram, mg/kg, in soil;

b - SCG: Part 375-6.8(a), Unrestricted Soil Cleanup Objectives.

c - SCG: Part 375-6.8(b), Restricted Use Soil Cleanup Objectives for the Protection of Public Health for Restricted Residential Use, unless otherwise noted.

d – Due to lack of chemical speciation for chromium, samples are conservatively compared to the SCO for hexavalent chromium.

ND = Not detected

Shallow soil samples were collected at the site during the RI. Surface soil samples were collected from a depth of 4-10 inches due to the gravelly nature of the site surface. The results indicate that surface soil at the site exceeds the unrestricted SCOs for inorganics but did not exceed the restricted residential SCOs.

Table 3 – Sub-Surface Soil

Detected Constituents	Concentration Range (ppm) ^a	Unrestricted Use SCO ^b (ppm)	Frequency Exceeding Unrestricted Use SCO	Restricted Residential Use SCO (ppm) ^c	Frequency Exceeding Restricted SCO
Inorganics					
Chromium	14.8-20.1	1 ^d	10 out of 11	110 ^d	0 out of 11
Nickel	ND-39.8	30	9 out of 11	310	0 out of 11
Organics					
Acetone	ND-0.088	0.05	4 out of 11	100	0 out of 11
Ethyl benzene	ND-6.2	1	3 out of 11	41	0 out of 11
Xylene	ND-6	0.26	1 out of 11	100	0 out of 11
*VOC TICs	ND-210				
*SVOC TICs	ND-483				

a - ppm: parts per million, which is equivalent to milligrams per kilogram, mg/kg, in soil;

b - SCG: Part 375-6.8(a), Unrestricted Soil Cleanup Objectives.

c - SCG: Part 375-6.8(b), Restricted Use Soil Cleanup Objectives for the Protection of Public Health for Restricted Residential Use, unless otherwise noted.

d – Due to lack of chemical speciation for chromium, samples are conservatively compared to the SCO for hexavalent chromium.

ND = Not detected

* TICs are tentatively identified compounds, in this case most likely breakdown products of petroleum without assigned cleanup values.

Subsurface soil samples were collected from a depth of 2 - 22 feet to assess soil contamination. The results indicate that subsurface soils at the site exceed the unrestricted SCOs for volatile organics and metals. Although not reflected in the sample results, petroleum contamination in the form of stained soils and odors was apparent in soil observed during test pitting both on and off-site. Tentatively identified compounds (TICs) ranged from not detected (ND) to 210 ppm for VOCs and ND to 483 ppm for SVOCs.

Table 4 – Off-Site Soil – Canalway Trail

Detected Constituents	Concentration Range (ppm) ^a	Unrestricted Use SCO ^b (ppm)	Frequency Exceeding Unrestricted Use SCO	Residential Use SCO (ppm)	Frequency Exceeding Residential SCO
Inorganics					
Chromium	8.36-19.6	1 ^d	7 out of 7	22 ^d	0 out of 7
Nickel	ND-30.3	30	1 out of 7	140	0 out of 7
Organics					
Acetone	ND-0.26	0.05	8 out of 12	100	0 out of 12
*VOC TICs	ND-1.4				
*SVOC TICs	ND-163				

a - ppm: parts per million, which is equivalent to milligrams per kilogram, mg/kg, in soil;

b - SCG: Part 375-6.8(a), Unrestricted Soil Cleanup Objectives.

d – Due to lack of chemical speciation for chromium, samples are conservatively compared to the SCO for hexavalent chromium.

ND = Not detected

* TICs are tentatively identified compounds, in this case most likely breakdown products of petroleum without assigned cleanup values.

The results indicate that soils at the site exceed the unrestricted SCOs for VOCs and metals but did not exceed the residential SCOs.

Table 5 – IRM Confirmation Soil Sample Results

Detected Constituents	Concentration Range (ppm) ^a	Unrestricted Use SCO ^b (ppm)	Frequency Exceeding Unrestricted Use SCO	Residential Use SCO (ppm)	Frequency Exceeding Residential SCO
Inorganics					
Chromium	13.5-22	1 ^d	7 out of 7	22 ^d	1 out of 7
Nickel	ND-37.7	30	2 out of 7	140	0 out of 7
Organics					
Acetone	ND-0.081	0.05	5 out of 7	100	0 out of 7
Xylene	ND-1	0.26	1 out of 7	100	0 out of 7
Ethylbenzene	ND-1.7	1	1 out of 7	30	0 out of 7

a - ppm: parts per million, which is equivalent to milligrams per kilogram, mg/kg, in soil;

b - SCG: Part 375- 6.8(a), Unrestricted Soil Cleanup Objectives.

d – Due to lack of chemical speciation for chromium, samples are conservatively compared to the SCO for hexavalent chromium.

ND = Not detected

Note - PCBs were detected in the soil samples but were all below unrestricted SCOs.

The confirmation sample with a detection of xylene and ethylbenzene was a sample located below the former oil/storm water separator at a depth of 11 feet. Further excavation during the IRM was precluded because of potential stability issues in the adjacent canal wall.

Based on the findings of the Remedial Investigation and the confirmation subsurface soil results collected during the IRM, the presence of petroleum products from past operations has resulted in the contamination of site soil. The site contaminants identified in soil which are considered to be the primary contaminants of concern are metals and petroleum constituents. The source removal IRM conducted in 2009 considerably reduced the amount of contamination in the subsurface, and removed all source material. No additional remediation of subsurface soil is necessary. Remaining soil contamination will be addressed in the remedy selection process.

Soil Vapor

The evaluation of the potential for soil vapor intrusion resulting from the presence of site related soil or groundwater contamination was not evaluated by quantitative sampling. Field readings with a photoionization detector recorded VOC readings in the range of 3.5 to 1,091 ppm in the on-site soil borings and 1.5 to 330 ppm in the off-site borings. Since there are no structures on-site or on the adjacent Canalway Trail and soil and groundwater sampling showed only minimal VOC impacts, soil vapor was not further evaluated.

Soil vapor contamination for future development will be addressed in the remedy.

Exhibit B

Description of Remedial Alternatives

The following alternatives were considered based on the remedial action objectives (see Section 6.5) to address the contaminated media identified at the site as described in Exhibit A.

Alternative 1: No Further Action

The No Further Action Alternative recognizes the remediation of the site completed by the IRM(s) described in Section 6.2. This alternative leaves the site in its present condition and does not provide any additional protection of the environment or public health.

Alternative 2: Soil Cover with Institutional Controls

This alternative would include, a site cover to allow for restricted residential use of the site. The cover will consist either of structures such as buildings, pavement, sidewalks comprising the site development or a soil cover in areas where the upper two feet of exposed surface soil will exceed the applicable soil cleanup objectives (SCOs). Where the soil cover is required it will be a minimum of two feet of soil, meeting the SCOs for cover material as set forth in 6 NYCRR Part 375-6.7(d) for restricted residential use. The soil cover will be placed over a demarcation layer, with the upper six inches of the soil of sufficient quality to maintain a vegetation layer. Any fill material brought to the site will meet the requirements for the identified site use as set forth in 6 NYCRR Part 375-6.7(d). This alternative also included the implementation of an institutional control in the form of an environmental easement and associated site management plan for the entire OU-1 area to prevent potential exposure to groundwater, limit use to restricted residential and ensure that the soil cover is properly maintained and contaminated soil remaining at the site is properly managed.

Present Worth: \$205,000

Capital Cost: \$147,000

Annual Costs: \$3,000

Alternative 3: Soil Excavation and Off-Site Disposal

This alternative achieves all of the SCGs discussed in Section 6.1.1 and Exhibit A, and would result in soil meeting the unrestricted soil cleanup objectives listed in Part 375-6.8 (a). This alternative would include: excavation and off-site disposal of all soil contamination above the unrestricted soil cleanup objectives, estimated to be 44,770 cubic yards. The remedy would not rely on institutional or engineering controls to prevent future exposure. There is no Site Management, no restrictions, and no periodic review. This remedy will have no annual cost, only the capital cost.

Present Worth: \$6,667,000

Capital Cost: \$4,789,000

Annual Costs: \$3,000

Exhibit C

Remedial Alternative Costs

Remedial Alternative	Capital Cost (\$)	Annual Costs (\$)	Total Present Worth (\$)
No Action	0	0	0
Soil Cover with Institutional Controls	147,000	3,000	205,000
Soil Excavation and Off-Site Disposal	4,789,000	3,000	6,667,000

Exhibit D

SUMMARY OF THE SELECTED REMEDY

The Department has selected Alternative 2, Soil cover with institutional controls as the remedy for this site. Alternative 2 would achieve the remediation goals for the site by covering any remaining contaminated soil. This cover in combination with the previous interim remedial action which removed the main sources of contamination and the placement of an environmental easement on the site will effectively protect human health and the environment. The elements of this remedy are described in Section 7. The selected remedy is depicted in Figure 5.

Basis for Selection

The selected remedy is based on the results of the RI and the evaluation of alternatives. The criteria to which potential remedial alternatives are compared are defined in 6 NYCRR Part 375. A detailed discussion of the evaluation criteria and comparative analysis is included in the AA report.

The first two evaluation criteria are termed "threshold criteria" and must be satisfied in order for an alternative to be considered for selection.

1. Protection of Human Health and the Environment. This criterion is an overall evaluation of each alternative's ability to protect public health and the environment.

Alternative 1 (No Action) does not provide any protection to public health and the environment and will not be evaluated further.

The selected remedy (Alternative 2) would satisfy this criterion by covering the contaminated subsurface soils. Alternative 2 relies on a restriction of groundwater use at the site to protect public health. Soil vapor issues will be addressed by Alternative 2 when any new structures are constructed at the site.

Alternative 3, by removing all soil contaminated above the unrestricted soil cleanup objective, meets the criteria. Alternative 3 may require a short-term restriction on groundwater use; however, it is expected the restriction may be able to be removed in approximately three years. Soil vapor contamination is expected to be addressed through the removal of all contaminated on-site soils by Alternative 3.

2. Compliance with New York State Standards, Criteria, and Guidance (SCGs). Compliance with SCGs addresses whether a remedy will meet environmental laws, regulations, and other standards and criteria. In addition, this criterion includes the consideration of guidance which the Department has determined to be applicable on a case-specific basis.

Alternative 2 complies with SCGs to the extent practicable. It addressed source areas of contamination by the IRM, and complies with the restricted use soil cleanup objectives at the surface through construction of a cover system. It also creates the conditions necessary to restore groundwater quality in time. Because Alternatives 2 and 3 satisfy the threshold criteria, the remaining criteria are particularly important in selecting a final remedy for the site. It is expected Alternative 3 will achieve groundwater SCGs in less than 5 years, while groundwater contamination above SCGs will remain on-site under Alternative 2 for many years.

The next six "primary balancing criteria" are used to compare the positive and negative aspects of each of the remedial strategies.

3. Long-term Effectiveness and Permanence. This criterion evaluates the long-term effectiveness of the remedial alternatives after implementation. If wastes or treated residuals remain on-site after the selected remedy has been implemented, the following items are evaluated: 1) the magnitude of the remaining risks, 2) the adequacy of the engineering and/or institutional controls intended to limit the risk, and 3) the reliability of these controls.

Long-term effectiveness is best accomplished by those alternatives involving excavation of the contaminated overburden soils (Alternative 3). Alternative 3 results in removal of almost all of the chemical contamination at the site and removes the need for property use restrictions and long-term monitoring. Alternative 2 creates a barrier, but it also requires an environmental easement, a groundwater use restriction, actions to address the potential for soil vapor intrusion and long-term monitoring in order to be effective. However the incremental benefit for Alternative 3 is offset by the high cost.

4. Reduction of Toxicity, Mobility or Volume. Preference is given to alternatives that permanently and significantly reduce the toxicity, mobility or volume of the wastes at the site.

Alternative 2 would control potential exposures with institutional controls only and will not reduce the toxicity, mobility or volume of contaminants remaining. Alternative 3, excavation and off-site disposal, reduces the toxicity, mobility and volume of on-site waste by transferring the material to an approved off-site location, and would entail the excavation of 44,770 cubic yards of material. However, the incremental benefit for Alternative 3 is offset by the high cost.

5. Short-term Impacts and Effectiveness. The potential short-term adverse impacts of the remedial action upon the community, the workers, and the environment during the construction and/or implementation are evaluated. The length of time needed to achieve the remedial objectives is also estimated and compared against the other alternatives.

Alternatives 2 and 3 both have short-term impacts which could be controlled, however, Alternative 2 would have the smallest impact. Alternative 3 would have a much greater impact due to the traffic and potential odor releases associated with excavation of a large volume of soil with residual petroleum impacts. The time needed to achieve the remediation goals is the shortest for Alternative 2 (2 months) and longer for Alternative 3 (4 months).

6. Implementability. The technical and administrative feasibility of implementing each alternative are evaluated. Technical feasibility includes the difficulties associated with the construction of the remedy and the ability to monitor its effectiveness. For administrative feasibility, the availability of the necessary personnel and materials is evaluated along with potential difficulties in obtaining specific operating approvals, access for construction, institutional controls, and so forth.

Alternative 2 is favorable in that it is readily implementable. Alternative 3 is also implementable but much more difficult since excavation would entail digging below the water table in close proximity to the Barge Canal and local roadways. The volume of soil excavated under this alternative would necessitate increased truck traffic on local roads for four months.

7. Cost-Effectiveness. Capital costs and annual operation, maintenance, and monitoring costs are estimated for each alternative and compared on a present worth basis. Although cost-effectiveness is the last balancing criterion evaluated, where two or more alternatives have met the requirements of the other criteria, it can be used as the basis for the final decision.

The costs of the alternatives vary significantly. Alternative 2 has a low cost (\$205,000), but the contaminated soil would require long-term management using institutional controls. With its large volume of soil to be handled, Alternative 3 (excavation and off-site disposal) would have the highest capital cost (\$6,667,000). The long-term maintenance cost of the capped area with Alternative 2 would be higher than long-term maintenance under Alternative 3. However, the incremental benefit for Alternative 3 is offset by the high cost.

8. Land Use. When cleanup to pre-disposal conditions is determined to be infeasible, the Department may consider the current, intended, and reasonable anticipated future land use of the site and its surroundings in the selection of the soil remedy.

Since the anticipated use of the site is restricted residential, Alternative 2 would comply with this criterion by providing a site cover that is consistent with such use. Alternative 3 would remove the contaminated soil permanently and would make restrictions on the site use unnecessary.

The final criterion, Community Acceptance, is considered a "modifying criterion" and is taken into account after evaluating those above. It is evaluated after public comments on the Proposed Remedial Action Plan have been received.

9. Community Acceptance. Concerns of the community regarding the investigation, the evaluation of alternatives, and the PRAP are evaluated. A responsiveness summary was prepared that describes public comments received and the manner in which the Department addressed the concerns raised, if any. The selected remedy does not differ significantly from the proposed remedy. Therefore, the ROD selected Alternative 2 as described above, because it satisfies the threshold criteria and provides the best balance of the balancing criterion.

Therefore, Alternative 2 is the selected remedy for this site.



400 0 400 Feet

Barton & Loguidice, P.C.

Engineers • Environmental Scientists • Planners • Landscape Designers

CITY OF ROME
INVESTIGATION OF ENVIRONMENTAL
RESTORATION PROGRAM SITES

LAWRENCE STREET SITE

CITY OF ROME ONEIDA COUNTY, NEW YORK

FIGURE
1[^]

Plotted: Jul 28, 2016 - 1:09PM
 i:\Shared\200\245005-S\SIR FIGURES\REMEDIATION INVESTIGATION REPORT 245001_REM_INV_701 LAWRENCE 072816.dwg
 Checked by: JCS
 Drawn by: JGH
 In charge of: SDN



NO ALTERATION PERMITTED
 HEREON EXCEPT AS PROVIDED
 UNDER SECTION 2209
 SUBDIVISION 2 OF THE NEW
 YORK STATE EDUCATION LAW.

COMPLETED CONSTRUCTION

Significant Construction
 Changes Are Shown

By: _____ Date: _____
 Ck'd: _____ Date: _____

REVISIONS

NO.	DESCRIPTION	DATE

CITY OF ROME
 ALTERNATIVE ANALYSIS REPORT
**701 LAWRENCE STREET
 SITE PLAN**
 ONEIDA COUNTY, NEW YORK
 CITY OF ROME

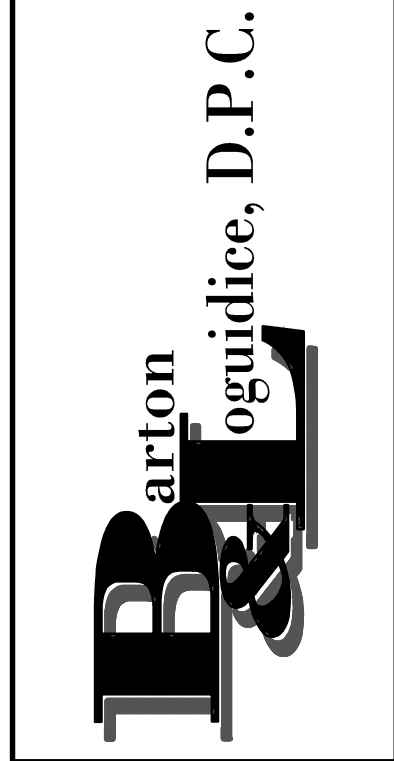

LEGEND	
	PROPERTY LINE AND SITE BOUNDARY
	MONITORING WELL LOCATION
	SOIL BORING LOCATION
	EXISTING SURFACE SOIL SAMPLE LOCATION
	FLOOR DRAIN/SURFACE SOIL SAMPLE LOCATION
	TEST PIT LOCATION
	TEST PIT (CANAL TRAIL INVESTIGATION)
	SOIL BORING (CANAL TRAIL INVESTIGATION)

NOTE:
 MONITORING WELL LOCATIONS BASED ON SURVEY,
 OTHER SAMPLE LOCATIONS ARE APPROXIMATE.

Date	JULY, 2016
Scale	AS SHOWN
Sheet Number	2
File Number	245.005

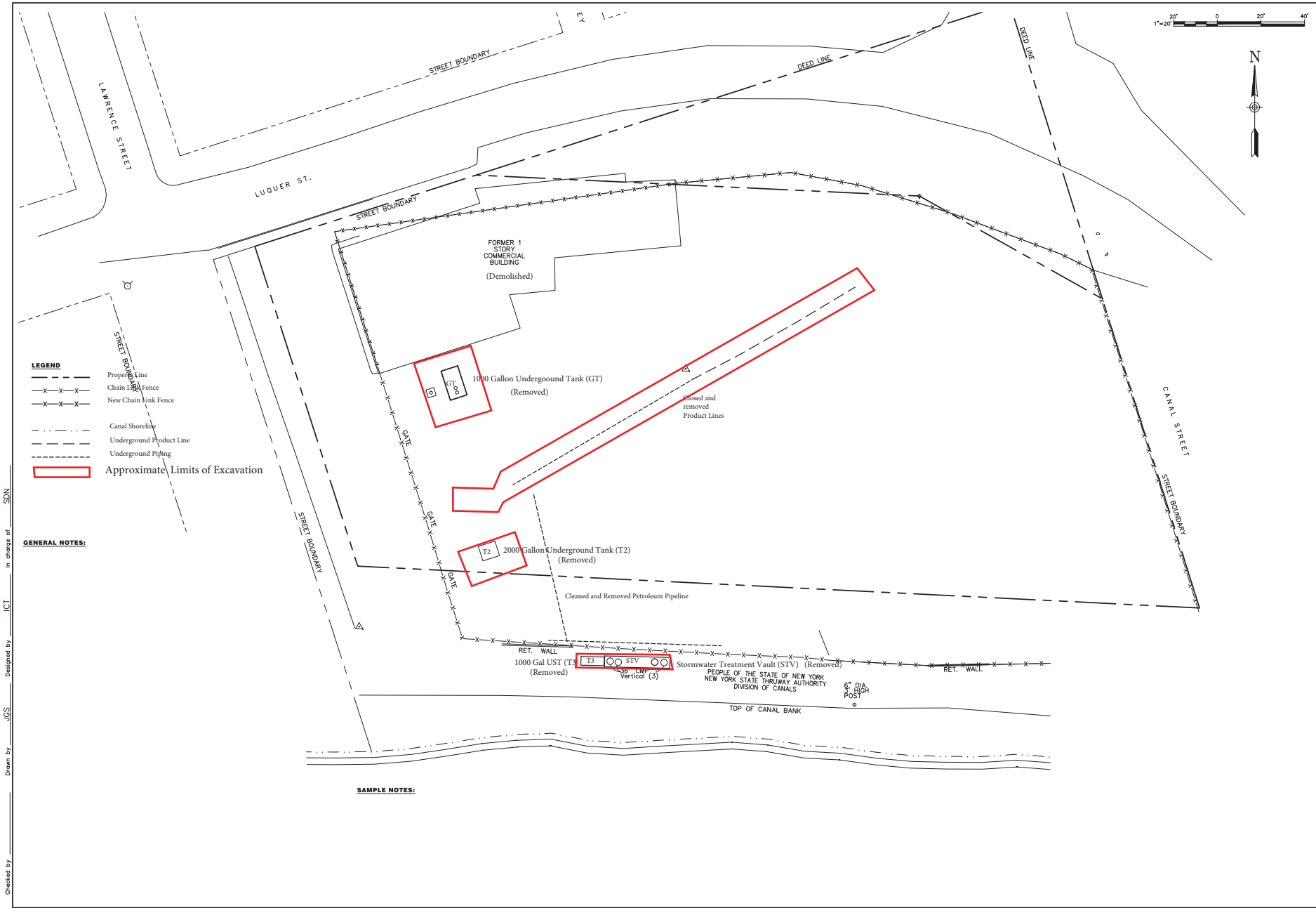

- LEGEND**
- Property Line
 - - - Chain Link Fence
 - x - x - x - New Chain Link Fence
 - - - Canal Shoreline
 - - - - - Underground Product Line
 - - - - - Underground Piping
 - ▭ (Red) Approximate Limits of Excavation

GENERAL NOTES:

SAMPLE NOTES:

NO ALTERATION PERMITTED HEREON EXCEPT AS PROVIDED UNDER SECTION 7209 SUBDIVISION 2 OF THE NEW YORK STATE EDUCATION LAW.

COMPLETED CONSTRUCTION

Significant Construction Changes Are Shown

By _____ Date _____

CK'd _____ Date _____

REVISIONS

No.	Description	Date

CITY OF ROME
 REMEDIAL INVESTIGATION
701 LAWRENCE STREET
 IIRM LOCATION PLAN
 ONEIDA COUNTY, NEW YORK
 CITY OF ROME



Date
 JUNE, 2014

Scale
 AS SHOWN

Figure
3

File Number
 245.005

Checked by _____ Drawn by _____ JCS Designed by _____ ICT in charge of _____ SDN



Luquer St

Lawrence St

E Whitesboro St

Canalway Trail

Canalway Trail

Figure 4

© 2016 Google

Google earth

1997

Imagery Date: 5/13/2015 43°12'07.46" N 75°27'22.20" W elev 432 ft eye alt 995 ft



701 Lawrence St. Site #E633063
Luquer & Lawrence
Proposed Soil Cover Extent

arlton
oguidice, D.P.C.
BA

Figure
5

APPENDIX A

Responsiveness Summary

RESPONSIVENESS SUMMARY

701 Lawrence Street

Operable Unit Number: 01

Environmental Restoration Project

City of Rome, Oneida County, New York

Site No. E633063

The Proposed Remedial Action Plan (PRAP) for the 701 Lawrence Street Operable Unit Number 1 (OU-1) site was prepared by the New York State Department of Environmental Conservation (the Department) in consultation with the New York State Department of Health (NYSDOH) and was issued to the document repositories on December 22, 2016. The PRAP outlined the remedial measure proposed for the contaminated soil and groundwater at the Operable Unit Number 1 at the 701 Lawrence Street (OU-1) site.

The release of the PRAP was announced by sending a notice to the public contact list, informing the public of the opportunity to comment on the proposed remedy.

A public meeting was held on January 19, 2017, which included a presentation of the remedial investigation, alternative analysis (RI/AA) for the 701 Lawrence Street (OU-1) site as well as a discussion of the proposed remedy. The meeting provided an opportunity for the public to discuss their concerns, ask questions and comment on the proposed remedy. These comments have become part of the Administrative Record for this site. The public comment period for the PRAP ended on February 7, 2017.

This responsiveness summary responds to all questions and comments raised during the public comment period. The following are the comments received at the public meeting, with the Department's responses:

COMMENT 1: Please explain what is a site cover? How much of the site would contain a soil cover?

RESPONSE 1: A site cover may consist of soil in green spaces, parking areas, sidewalks, buildings, or a combination of all of them. A site cover eliminates the potential for exposure to contaminants which may remain in subsurface soil and will be handled by the site management plan. For a commercial use remediation, the required thickness of the cover is one foot. For the 701 Lawrence Street Site the entire site requires a cover, but the composition of the cover will depend on the development plan for the site. The extent of the soil cover largely depends on the development plan for the site after it is clean. The City or other developer may choose to temporarily install a site-wide soil cover until the site is fully developed.

COMMENT 2: Another Environmental Restoration Program (ERP) site recently completed in Rome in 2015 and has a crowned soil cover, what is the purpose of that?

RESPONSE 2: The comment is referring to the cover installed at 1201 East Dominick Street site (Site #E633065). The site remedy consisted of a temporary site-wide soil cover. The soil cover was installed at the site so that the City of Rome could proceed with the completion of the remedial program for the site and receive a Certification of Completion (COC) and associated liability releases granted under the ERP. The land use for this site was restricted residential, so a two foot soil cover was placed on top of the existing ground surface and was sloped towards the site boundary to provide proper drainage. Additionally, soil was excavated around the perimeter of the site to accommodate the required two feet of cover at the site boundary. This soil was placed underneath the cover and tapered to meet the existing grade at the property boundaries, resulting in the crowned look of the site. Should the site be developed in the future, the temporary cover could be replaced by sidewalks, buildings, parking area or in areas of green space, soil as provided for by the cover for this site.

COMMENT 3: What is the time schedule for the next phase of the project? What comes next?

RESPONSE 3: The Department is issuing the Record of Decision (ROD) which memorializes the remedy for the site. Following the ROD, the City of Rome can market the property to a potential developer who would have to implement the ROD remedy. They could do so by entering the Department's Brownfield Cleanup Program. The City may also apply to the ERP, which is being reactivated, to conduct the remedy. The ERP is not presently taking applications but is anticipated to be activated in the near future.

After the City and/or new owner applies to any of the programs mentioned above and is accepted, a revised project schedule will be prepared and approved by the Department for implanting the remainder of the remedial program. The remainder of the remedial program would consist of preparing a Remedial Design, followed by Remedial Construction to implement the remedy in accordance with the ROD.

COMMENT 4: Can the city enter into the Brownfield cleanup program (BCP)? Does the BCP allow for co-applicants with the City?

RESPONSE 4: The City can apply to enter the BCP to implement the remainder of the remedial program. The City could also be a co-applicant with a private developer in the BCP.

APPENDIX B

Administrative Record

Administrative Record

701 Lawrence Street (OU-1)

Environmental Restoration Project

City of Rome, Oneida County, New York

Site No. E633063

1. Proposed Remedial Action Plan for the 701 Lawrence Street (OU-1) site, dated December 21, 2016 prepared by the Department.
2. State Assistance Contract, Contract No. C303404, between the Department and the City of Rome, June 2007.
3. Barton & Loguidice, P.C. (B&L). 2008, Site Investigation Work Plan.
4. Barton & Loguidice, P.C. (B&L). 2012, Interim Remedial Measures (IRM) Construction Completion Report.
5. Buck Engineering, LLC. 2002, Limited Scope Environmental Assessment
6. Alternatives Analysis Report (AAR) prepared by Barton & Loguidice, P.C. (B&L), dated May 2015.
7. Citizen Participation Plan, May 2008.

The experience to
listen
The power to
solveSM

Barton
&Loguidice

www.bartonandloguidice.com