

**Limited Phase II Environmental Site Investigation (ESI) for
515 West 18th Street
Manhattan, New York 10011**

Prepared for:

Semantic Realty LLC
362 Kingsland Avenue
Brooklyn, New York 11223

Prepared by:

**CORE**
ENVIRONMENTAL
46-11 54th Avenue
Maspeth, NY 11378

March 7, 2012

TABLE OF CONTENTS

EXECUTIVE SUMMARY 1
 CONCLUSIONS AND RECOMMENDATIONS 2

1.0 INTRODUCTION 1

 1.1 PURPOSE 1

 1.2 SITE DESCRIPTION 1

 1.2.1 Previous Investigative Activities and Reports 2

 Remedial Investigation Report by Arcadis (2007) 2

 Site Characterization Study Report by TRC (2006) 3

 1.2.2 Previous Site DEC Spill Reports 4

 Spill #9612012 4

 Spill #9514181 5

 1.2.3 Previous Area DEC Spill Reports 5

 Spill #9210231 5

 Spill #9907805 6

 Spill #9406402 6

 Spill #0311002 6

 1.3 SCOPE OF WORK 7

2.0 FIELD INVESTIGATION 8

 2.1 SOIL SAMPLING 8

 2.2 GROUNDWATER SAMPLING AND ANALYSIS 9

3.0 INVESTIGATIVE RESULTS 10

 3.1 SOIL DESCRIPTION 10

 Soil Boring Summary Table 10

 3.2 BEDROCK DESCRIPTION 11

 3.3 GROUNDWATER DESCRIPTION 11

 3.4 LABORATORY RESULTS FOR SOIL SAMPLES 11

 3.4.1 Volatile Organic Compounds (VOCs) in Soil 11

 3.4.2 Semi Volatile Organic Compounds (SVOCs) in Soil 12

 3.5 LABORATORY RESULTS FOR GROUNDWATER SAMPLES 12

 3.5.1 VOCs in Groundwater 12

 3.5.2 SVOCs in Groundwater 13

4.0 FINDINGS, CONCLUSIONS AND RECOMMENDATIONS 14
 CONCLUSIONS AND RECOMMENDATIONS 16

5.0 STATEMENT OF LIMITATIONS 19

6.0 REFERENCES 21

ATTACHMENTS

TABLES

- 1 Summary of VOCs from Previous Investigations
- 2 Summary of SVOCs from Previous Investigations
- 3 Summary of VOCs in Soil
- 4 Summary of SVOCs in Soil
- 5 Summary of VOCs in Groundwater
- 6 Summary of SVOCs in Groundwater

FIGURES

- 1 Site Location Map
- 2 Site Plan and Adjacent Lots
- 3 Historical Manufactured Gas Plant Structures
- 4 Previous Investigations Sample Locations
- 5 Historical Vicinity Spill Sites
- 6 Soil Boring and Monitoring Well Plan
- 7 Groundwater Contour Plan
- 8 Summary of VOCs Detected in Subsurface Soil Plan
- 9 Summary of SVOCs Detected in Subsurface Soil Plan
- 10 Summary of VOCs Detected in Groundwater Plan
- 11 Summary of SVOCs Detected in Groundwater Plan

APPENDICES

- A Historical Spill Site Information
- B Soil Boring Logs
- C Monitoring Well Construction Details
- D Monitoring Well Development Logs
- E Monitoring Well Sampling Logs
- F Analytical Laboratory Reports

Executive Summary

This Limited Phase II Environmental Site Investigation (ESI) Report has been prepared by CORE Environmental, Inc. (CORE) for the property located at 515 West 18th Street, Manhattan, New York. The report details the methods, procedures and results of site investigation activities conducted between January 23rd, 2012 and February 6th, 2012.

The ESI was requested by the New York State Department of Environmental Conservation (NYSDEC) to determine if former underground storage tanks (USTs) located at the site impacted soil and/or groundwater. Former site USTs were either removed or closed in place. It has already been determined by previous ESIs at this site and adjoining sites that the Manufactured Gas Plant (MGP) Structures located adjacent to this site has impacted the soil and groundwater beneath the site.

The key findings of the site investigation are summarized below:

- The review of previous completed ESIs indicates that the former gas holders located on the adjacent lot are underlain by areas of MGP waste and MGP impacted fill which provides a constant source of contaminants migrating in the area groundwater upward and throughout the overburden soil in the area.
- Native soils, typically brown, fine to medium sand and varying amounts of silt, were identified between 5 to 11 feet below typical fill material. Next, silt was found to precede a gray clay layer at approximately 19 to 20 feet bgs. Bedrock was not encountered.
- Groundwater, identified from approximately 8 to 9.5 feet bgs, flows toward the southwest.
- Volatile Organic Compounds (VOC's) were detected above the compound specific guidance values (SGV) in two (2) of the eight (8) soil samples collected. The soil borings are both located upgradient of the UST area. The soil samples collected immediately adjacent to the UST area did not exhibit VOC's above SGV's.
- Semi-volatile organic compounds (SVOC's) were detected above the SGVs in two (2) of the eight (8) soil samples collected. These SVOCs are polycyclic aromatic hydrocarbons (PAHs) compounds which are indicative of historic NYC fill which contains coal tar waste.
- Benzene was detected at levels greater than the SGVs in eight (8) of nine (9) groundwater samples. Three (3) of these groundwater samples were collected hydraulically upgradient from the UST area while five (5) were collected from monitoring wells hydraulically downgradient from the UST area.
- Four (4) of the nine (9) wells exhibited one (1) SVOC at levels greater than the SGVs.

The location and differing nature of the VOCs detected in two (2) soil borings suggest they are not connected in a larger area. Evidence of this is that similar compounds were not detected in the soil

borings located between these borings. The contamination appears to be limited and localized in the vicinity of these soil boring locations and may be the result of a past on or off site fuel release.

Two (2) soil borings with SVOCs above the SGVs and two (2) additional soil borings with similar SVOCs at levels below the SGVs were identified upgradient and cross gradient from the UST area. The location and similar nature of the detected contaminants (PAHs) in these soil borings suggest the contaminated area may be connected and likely from onsite fill material.

The soils borings completed in the vicinity of the UST area did not indicate subsurface soil contamination resulting from the USTs is present. Based upon this data it appears the USTs were properly closed in place and are not presenting a source of site contaminants.

Benzene was detected in eight (8) of nine (9) monitoring wells. The highest total VOC concentrations were detected in MW-2, downgradient from the former UST area, however the two (2) monitoring wells upgradient of the UST area also indicated benzene and benzene, toluene, ethylbenzene and xylene (BTEX) concentrations above the SGVs. Based on the site data, the UST contents may have contributed to onsite contamination. However, the site wide presence of benzene, one of the most soluble and common compounds associated with MGP wastes, suggests the source is not the UST area.

One (1) SVOC, each considered a PAH, was detected above the SGV in three (3) onsite monitoring wells. An additional offsite monitoring well also had one (1) SVOC above the SGV. Three (3) of the wells are located in the sidewalk along the north side of West 18th Street and the fourth is inside the site building. The presence of PAHs in monitoring wells south of the site and adjoining site suggests that they are resulting from localized impacted fill containing MGP wastes.

Conclusions and Recommendations

Based on the findings from previous site investigations, which included soil borings and monitoring wells on the subject site and adjoining site, MGP contamination is present on adjoining sites including Lot 29, which is located immediately upgradient. The contamination is characterized by visible oil-like material, tar-like material, sheen, black staining, and MGP-related odors in the subsurface soil and/or groundwater. Additionally, previous investigations completed onsite and in the vicinity indicated widespread benzene contamination of groundwater.

Borings, monitoring wells and a test pit were placed in the area, including the adjoining site (Lot 29), as part of the 2006 investigation by TRC. MGP evidence was noted in seven (7) soil borings in Area 2 which included three (3) on Lot 29 which identified the MGP evidence in SB-7 (19 to 35 feet bgs), SB-9 (22-26 feet bgs) and SB-11 (21 to 33 feet bgs). Concentrations of one VOC, benzene, in shallow groundwater exceeded the SGVs while SVOCs were not detected in excess of the

SGVs. These borings and monitoring wells indicate that MGP waste is present in subsurface soils and benzene in shallow upgradient wells is widespread.

Borings and monitoring wells were placed in the area as part of the 2007 investigation by Arcadis. MGP evidence was noted at three (3) soil boring locations, including SB-MTP-2 (19 feet bgs) which is located on Lot 29. The remaining two (2) locations with MGP evidence were SB-224 (34.5 feet bgs) and SB-272 (15 to 20 feet bgs). SB-224 is located south of Lot 29 near the corner of 18th Street and 10th Avenue while SB-272 is located southwest of the site building on the north side of 18th Street. The concentrations of VOCs, including BTEX, detected in shallow groundwater exceeded the SGV. One VOC, benzene was most frequently present and exceeded the SGV. SVOCs were not detected in excess of the SGVs. These borings and monitoring wells also indicate that MGP waste is present in subsurface soils and benzene in shallow upgradient wells is widespread.

Furthermore, based on the number of petroleum spills in the area, the impacts from offsite spill sites to the subject site cannot be discounted. There are over 50 reported spill sites located within a ½ mile of the subject site. CORE suspects that the VOCs detected in groundwater (including BTEX) may have migrated onsite through groundwater since many of the spills are located upgradient of the site and not all spills are closed and/or remediated.

Based on the findings of this investigation, VOC's have impacted site soil in the southern area of the site at two (2) discrete localized areas; specifically in the vicinity of SB-3 and SB-5. SVOC's appear to have impacted site soil in the vicinity of SB-6 and SB-7. Similar to previous investigations completed onsite and in the vicinity widespread benzene contamination was identified in groundwater. The only monitoring well which was not contaminated with benzene is located upgradient to the former gas holders.

The USTs located on site may have contributed to the VOC impact to groundwater but the continued migration of VOC contamination from off-site sources is believed to be the primary source of groundwater contamination. The diffusion of benzene from the source material continues to impact the groundwater in the former MGP site area as well as downgradient areas. The previous subsurface investigations completed on the adjoining lot near and beneath the former gas holders consistently identified the highest concentrations of benzene at depths where the former gas holder bottoms were located. In comparison, the upper areas of soil had a much lower benzene concentrations. This conclusion is supported by each of the previously completed subsurface investigative activities which consistently identify the widespread BTEX contamination of soils and groundwater. Each of the investigations identified benzene with the highest frequency of exceedances as well as its widespread nature. Furthermore, this investigation identified the prevalence of benzene in the groundwater, but it was not detected in any soil sample analyzed from the site, even the samples located near the former UST area were absent of benzene.

Understanding that there is a constant source of VOCs migrating through groundwater upward and throughout the overburden in the area from the MGP waste and MGP impacted fill, it is our opinion that minor removal or treatment of localized petroleum affected soil or groundwater will not be effective. This is based on the fact that a constant source of VOCs is located upgradient and below the site and all site USTs have been closed and/or removed and do not represent a source. The findings from previous site investigations indicate that soil and groundwater at the subject site has been contaminated by the former MGP and a contamination source is still present. Therefore, remediation efforts of small localized areas of limited VOCs and/or SVOCs, including PAHs, will be unproductive and unsuccessful until the larger predominant contamination sources from MGP operations have been fully removed and/or remediated.

CORE does not recommend remedial actions at this site. In the event limited subsurface remediation of soil or treatment of groundwater is required then it should be completed as part of site redevelopment activities. Furthermore, CORE recommends no further investigations be completed at the site since the previous site investigations as well as this investigation have defined the nature and extent of petroleum based contamination of subsurface soil and groundwater as well as the probable source.

1.0 Introduction

This Limited Phase II Environmental Site Investigation (ESI) Report has been prepared by CORE Environmental, Inc. (CORE) for the property located at 515 West 18th Street, Manhattan, New York. The work performed is a limited subsurface investigation of the property with sampling and analysis of site soil and groundwater. A total of eight (8) soil borings were completed, with six (6) soil borings completed with monitoring wells. The report details the methods, procedures and results of site investigative activities.

1.1 Purpose

The purpose of the borings/monitoring wells is to determine if the previously removed and closed in place underground storage tanks (USTs) impacted the soil and/or groundwater at the site. The impact to onsite soil and groundwater from the former Manufactured Gas Plant (MGP) operations as the source of site contamination has previously been documented and established by earlier ESIs.

1.2 Site Description

The site is located at 515 West 18th Street, Manhattan, New York. The parcel is located on Block 690 Lot 20, which is bounded by West 19th and West 18th Streets to the North and South. The Block is zoned as M1-5 and is defined as Light Manufacturing District-High Performance. A number of tanks were located onsite. Former site tanks consisted of three (3) 550 gallon gasoline USTs removed in 1999, two (2) 1,500 gallon diesel USTs closed in place in 1997 and one (1) 4,000 gallon diesel UST closed in place in 2004. A Site Location Map is included as Figure 1 and a Site Plan and Adjacent Lots is presented as Figure 2.

The site has a combined area of approximately 0.58 acres and includes a two story brick building which is approximately 46,000 SF (total floor space). The first floor of this structure is used as a parking garage for Verizon and the second floor formerly housed a Night Club (The Roxy). Records indicate that the main portion of the two story structure was built in 1920. Sanborn maps and Building Department records indicate an addition or additional building was added to the northern portion in 1947. These structures were primarily used as vehicle storage and fueling.

The adjoining parcel to the east is Lot 29 which consists of a fenced 23,000 sf paved lot which is used for vehicle parking. Lot 29 was occupied by MGP gas holders (Late 1800's through early 1900's). These gas holders were once part of a large MGP (The West 18th Street Gas Works Site) which occupied an area between West 16th and 20th Streets and 9th and 11th Avenues. Figure 3 Historical Manufactured Gas Plant Structures includes the site and adjoining area MGP structures.

1.2.1 Previous Investigative Activities and Reports

The findings from previous site investigations have indicated that the soil and groundwater quality at the subject site has been influenced by historical operations of the former MGP and contamination is present. Much of the contamination is resultant from MGP waste and MGP impacted fill which is characterized by visible oil-like material, tar-like material, sheen, black staining that is present. The presence of coal tar, which contains VOCs and the polycyclic aromatic hydrocarbons (PAHs) is well documented. The continued migration of VOC contamination from the MGP waste is the primary source of groundwater contamination in the area. The resultant VOCs, especially BTEX, from the source material continues to impact the groundwater in the former MGP site area as well as downgradient areas.

Previous area investigative reports were reviewed during the completion of this Limited ESI report. The previous reports and documents reviewed and summarized below include the following:

- *Remedial Investigation Report* for the Former West 18th Street Gas Works, Manhattan, New York, VCA Site # V00530-2 by Arcadis, BBL October 2006-March 2007.
- *Site Characterization Study Report* for the Former West 18th Street Gas Works, Manhattan, New York, VCA Site # V00530-2 by TRC Environmental Corporation dated January 2006.

Figure 4 Previous Investigations Sample Locations includes the location of the test pits, soil borings and monitoring wells completed in the vicinity of the subject site which are summarized in this section. The data is included in Table 1 Summary of VOCs from Previous Investigations and Table 2 Summary of SVOCs from Previous Investigations to highlight the contamination identified in these investigations.

Remedial Investigation Report by Arcadis (2007)

Remedial Investigation Report (RIR) activities were performed on behalf of Con Edison. The investigation indicated the following:

- Site soil includes a brown, black or grey fine to coarse silty sand that is beneath a layer of fill material that extends from the ground surface to a range of 5 to 20 feet below grade. A clay unit that forms an intermediate low permeability boundary between the water table and the lower aquifer appears to be present beneath the silty sands.
- Evidence of petroleum-related impacts, which included odors and elevated PID levels (ranged from 0 to 2,157 ppm) were detected from 10 ft bgs to depths ranging to 35 ft bgs.
- Subsurface structures associated with the northernmost gas holder including of the ring wall of former Gas Holder No. 3 was visually confirmed in test pit TP-2.
- VOCs and SVOCs, as well as metals were detected in subsurface soil at concentrations exceeding soil cleanup objectives.

- The concentration of BTEX, based on laboratory analysis, was highest in SB-208, SB-209, SB-210, SB-213, SB-222 and SB-254 at 19-20 feet bgs. In SB-210 the highest BTEX concentrations were at 21-23 feet bgs, while in SB-215 they were at 30-32 feet bgs, in SB-221 at 24-25 feet bgs, in SB-224 at 34.5-35 feet bgs, and in SB-272 at 16-17 feet bgs.
- The concentrations of VOCs, including BTEX, detected in shallow groundwater exceeded the SGV. One VOC, benzene was most frequently present and exceeded the SGV. SVOCs were not detected in excess of the SGVs.

Borings, monitoring wells and a test pit were placed on the subject site as part of the RIR. These included SB-208, SB-209, SB-213, SB-214, SB-219, SB-220, SB-221, SB-222, SB-254, SB-272, and SB-MTP-3. Additional soil borings and monitoring wells were placed upgradient on Lot 29 and included SB-210, SB-215, SB-223, SB-224, SB-273, SP-MTP-1, and SP-MTP-2. MGP evidence was noted at three (3) soil boring locations, including SB-272 (15 to 20 feet bgs), which is located on site. The adjoining site near the gas holder remains identified the remaining two (2) soil borings where MGP evidence was identified and included SB-224 (34.5 feet bgs) and SB-MTP-2 (19 feet bgs).

Based on the findings of the RIR soil and groundwater quality in and around the West 18th Street Gas Works Site has been contaminated. The investigations completed consistently identified the highest concentrations of BTEX in soil at depths from 19-20 feet bgs, which is where the bottom of the former gas holder were located, while upper soils had less BTEX present. The RIR also identified the BTEX in the groundwater as well.

Site Characterization Study Report by TRC (2006)

Site characterization study (SCS) activities were performed in accordance with a Voluntary Cleanup Agreement (VCA) (Index #D2-0003-02-08), between Con Edison and the NYSDEC, and in accordance with an approved work plan. The subject site is located in Area 2. The Summary of Findings for Area 2 is as follows:

- The silty/clay unit that forms an intermediate low permeability boundary between the water table and the lower aquifer appears to be continuous across Area 2. The depth to the top of the silty/clay unit varies.
- Evidence of petroleum-related impacts, which included odors and LNAPL, was prevalent in the water table aquifer and was typically detected from 1 ft bgs to depths ranging to 15 ft bgs. The petroleum is likely related operations of one or more USTs that were operated in this Area or the numerous petroleum spills that have been identified and documented in the vicinity of the Site.
- Structures associated with the two former gas holders are present in the subsurface in the eastern-most portion of Area 2. The southern portion of the ring wall of former Gas Holder No. 3 was visually confirmed in test pit TP-2, although the ring wall of former Gas Holder No.

4 could not be located. At SB-10, located inside former Gas Holder No. 4, the gas holder bottom was encountered.

- Where detected, evidence of MGP-residues (e.g., oil like material, tar like material, naphthalene odors, black staining, etc.) was detected as discrete narrow bands in 6 soil borings within the interval of 19 to 35 ft bgs in the eastern-most portion of this Area and adjacent to the area being remediated (Georgetown property) on the western end of Area 2 along Route 9A.
- VOCs, Total VOCs, SVOCs, Total SVOCs and metals were detected in subsurface soil at concentrations exceeding NYSDEC RSCOs. No pesticides, herbicides or PCBs were detected at concentrations in subsurface soil in excess of the NYSDEC RSCOs.
- Concentrations of one VOC, benzene, in shallow groundwater exceeded the NYSDEC AWQSGV. SVOCs were not detected in excess of the NYSDEC AWQSGVs. One metal, thallium, was detected in excess of the NYSDEC AWQSGV in the duplicate sample of MW-12B.

Based on the findings of the SCS, soil and or groundwater quality in Area 2 of the West 18th Street Gas Works Site have been influenced by historical operations of the former MGP and contamination is present. The contamination is characterized by visible oil-like material, tar-like material, sheen, black staining, and MGP-related odors in the subsurface soil and/or groundwater.

Borings, monitoring wells and a test pit were placed on the adjoining site as part of the SCS. These included SB-7 through SB-11, SB-14, MW-7A, MW-12A, and TP-2. MGP evidence was noted at seven (7) soil boring locations in Area 2 which included SB-7 (19 to 35 feet bgs), SB-9 (22-26 feet bgs) and SB-11 (21 to 33 feet bgs). These borings were placed on Lot 29 near the gas holder remains, which is upgradient to the sampling area completed as part of this ESI.

1.2.2 Previous Site DEC Spill Reports

Subject site DEC spill reports were reviewed during the completion of this Limited ESI report. Appendix A includes the spill report information from the NYSDEC web site as well as a portion of an EDR database report detailing spills information. The previous spill reports and documents reviewed and summarized below include the following:

Spill #9612012

This spill occurred at 515 West 18th Street and is related to contaminated soil encountered during the excavation and replacement of the two (2) 1,500 gallon diesel tanks with a 4,000 gallon diesel tank. The spill date is listed as January 6, 1997 and the material spilled is listed as diesel. The DEC spill report remarks indicate that the callers company was hired to replace 2 1,500 gallon tanks with 1 4,000 gallon tank and they discovered contaminated soil around the area of the tanks. Soil is being excavated. The spill is not closed. The 4,000 gallon UST was closed in place in 2004.

The site was identified on the DEC spill report database based on the two (2) aforementioned spills that were reported in 1996 and 1997. DEC Spill No. 9612012 remains open to date and is the reason for the continued investigation at the subject site.

Spill #9514181

This spill occurred at 515 West 18th Street and is related to the tank test failures on February 7, 1996 of two (2) 1,500 gallon diesel tanks. The DEC remarks in the spill report it was the result of a tank test failure and the file was transferred to another person at the DEC. The spill report listed the material as not identified and the amount as not applicable with no resource affected listed. The spill was later closed on March 18, 2009.

1.2.3 Previous Area DEC Spill Reports

Previous area spill reports were reviewed during the completion of this Limited ESI report. Appendix A includes the spill report information from the NYSDEC web site as well as a portion of an EDR database report detailing spills information. Over 50 reported spill sites are located within a ½ mile of the subject site. The spills location information for the spills listed in this section is depicted on Figure 5 Historical Vicinity Spill Sites. The previous spill reports and documents reviewed and summarized below include the following:

Spill #9210231

This spill, named Getty, occurred at 152 10th Avenue and is related to a tank test failure reported on December 3, 1992. The spill is located approximately 240 feet upgradient of the site. The material is listed as unknown. The spill was later closed on March 10, 2004. The site was occupied by a Getty gas station which was demolished for a mixed use and residential building. The disposition of the tank and extent of subsurface contamination is not known. Site notes by DEC indicated that the reason for tank closure is property divestment. Removal of one pump island located adjacent to 10th Avenue and twelve (550-gallon) gasoline USTs and one (550-gallon) waste oil tank from 3/23-3/25/98. Soil analytical show 9,990 ppb toluene (south wall), 10,600 ppb naphthalene (south wall), 10000 ppb toluene (west wall), 15,900 ppb naphthalene (west wall), 156 ppb MTBE (Bottom). Waste oil soil endpoint shows 427 ppb benzo(a)anthracene and 411 ppb benzo(b)fluoranthene.

Additional work consisted of further excavation of the west wall and the south wall of the gasoline tank field which resulted in clean (STARS Memo) endpoint soil samples from the two walls. Excavation indicated the presence of a former basement filled with demolition debris. Depth to groundwater was estimated at 9" below grade. Two additional soil end point samples were collected for analysis. Soil endpoint analysis shows no TAGM 4046 Soil Cleanup Objective exceedances after second excavation event. Summary Report indicated one groundwater

sampling event prior to the destruction of the wells during removal of underground storage tanks was completed. Groundwater analytical showed 173 ppb MTBE in W-1, 1,200 ppb MTBE in W-2 and 1,890 ppb MTBE in W-3.

A total of 305.11 tons of soil were removed from the tank field excavation. "The entire lot (approximately 114' x 100') has been excavated to the property lines and to a depth of approximately 15'. The spill was closed by the DEC on March 10, 2004, however there was no indication a corrective action investigation was performed.

Spill #9907805

The spill is named Old Gas Station and occurred at 10th Avenue / 20th Street and the cause is listed as housekeeping and the material released was reportedly gasoline. The spill was reported on September 28, 1999 and was later closed on March 4, 2003. The DEC Remarks for the spill indicate that while digging up the old tanks at the old gas station - severe odors present - Complainant has called NYC DEP already. The site is located upgradient approximately 160 feet from the subject site. The site was occupied by an old gas station which was demolished for a mixed use and residential building. The disposition of the tank and subsurface contamination is not known.

Spill #9406402

The spill is named Broadway Building Materials and occurred at 501-513 West 19th Street and the cause is listed as tank equipment failure and the material released was reportedly diesel which affected soil. The spill was reported on August 10, 1994 and is not closed. The site is located upgradient approximately 80 feet from the subject site. The disposition of the tank and subsurface contamination is not known.

Spill #0311002

The spill occurred on December 24, 2003 6, 1997 at a construction site located at 438 West 19th Street and is related to tanks encountered during the excavation. The spill site is located 500' east of the subject site. The DEC remarked that the caller found two tanks in ground, one they ruptured with machine. Unknown material noted seeping out. The DEC responded to the site to check a minor spill of 35 gallon tank and a larger spill from the removal of the 1500 gallon tank. DEC notified them that the excavator had uncovered two more tanks and they should also be registered before removal. The PBS registration indicates the two 550 gallon tanks are registered and classified as removed per 1/20/04.

On February 17, 2004 an Investigation Plan was received. On February 26, 2004 an investigation report prepared by Impact Environmental was submitted. Gasoline release from the two 550 gal

USTs has impacted soil and groundwater.

On July 6, 2004 the DEC reviewed and conditionally approved a RAP to install a soil vapor extraction (SVE) system. The SVE system was started on May 24, 2005 and was operated until 2006. On April 19, 2006 the DEC issued a no further action letter and closed the spill.

There are over 50 reported spill sites located within a ½ mile of the subject site. The elevated VOC concentrations detected on site are located downgradient from the former UST area, indicating the UST contents contributed to the site contaminants. CORE also suspects that the VOCs detected in groundwater (including BTEX) have migrated onsite through groundwater. This is based on the fact that many of the spills are located upgradient of the site and not all spills are closed and/or remediated.

1.3 Scope of Work

The field investigation was conducted between January 23rd, 2012 and February 6th, 2012 and consisted of the following:

- The drilling of eight (8) soil borings to a maximum depth of approximately 20 feet bgs and the collection of eight (8) soil samples for laboratory analysis.
- The installation of six (6) monitoring wells to approximately 20 feet bgs.
- The collection of nine (9) groundwater samples for laboratory analysis.
- A comparison of soil and groundwater data to the appropriate regulatory standards or guidance values (SGVs).
- Preparation of a groundwater contour map showing local groundwater flow direction.
- Preparation of figures depicting sample location points and detected compounds for soil and groundwater.
- Data review, evaluation and report preparation with findings, conclusions and recommendations.

2.0 Field Investigation

CORE subcontracted Aquifer Drilling & Testing (ADT) to advance eight (8) soil borings to facilitate the collection of soil samples and the installation of six (6) monitoring wells. Drilling activities and environmental sampling was completed under the direction of CORE Personnel. The soil borings and monitoring wells locations are shown in Figure 6 Soil Boring and Monitoring Well Plan.

2.1 Soil Sampling

Drilling and soil sampling was conducted utilizing a Sonic Drill AMS CRS-17-C Sonic Sampler for borings SB-1 and SB-2 and hollow stem augers and a split spoon sampler for borings SB-3 through SB-8. Soil samples from each borehole were field screened using a MiniRae® 2000 photo ionization detector (PID) to measure organic vapors. Appendix B contains the soil boring logs.

After hand auguring the first five (5) feet bgs continuous soil samples were collected from SB-1 and SB-2 at five (5) foot intervals using a three (3) inch diameter, five (5) foot long macro-core sampler. After hand auguring the first five (5) feet bgs continuous soil samples were collected from SB-3 through SB-8 at two (2) foot intervals using a Split Spoon Sampler.

Upon sampler retrieval, the soils were examined for visual evidence (i.e. staining, discoloration) and any olfactory indications (i.e. odors) of contamination. In addition, a photo-ionization detector (PID) was used to qualitatively screen the soil for VOCs. The PID screening procedure consisted of collecting the soil in a plastic zip-locked bag and inserting the PID into the bag following a 15-minute stabilization period. Soil which exhibited the highest PID readings or other indicators of contamination was selected for laboratory analysis. Soil classification information and PID readings are documented on the boring logs. The Split Spoon Sampler was cleaned between boring locations by a three-step washing process that consisted of a tap water rinse, followed by an Alconox® and tap water wash, followed by a distilled water rinse. The macro-core sampling equipment was steam cleaned prior to the start of drilling activities and unused pre-cleaned equipment was used for each new boring.

Soil samples were preserved at 4 degrees Celsius in a cooler with ice prior to and during shipment. Prior to shipment initial samples were stored in a refrigerator at the appropriate temperature. Chain-of-Custody documentation accompanied the samples during storage and shipment. The samples were sent to a certified laboratory for the analysis. York Analytical Laboratories, Inc. (York), a National Environmental Laboratory Accreditation Program (NELAP) accredited laboratory (Number 10854) performed the analysis on all the samples. Samples were analyzed for the 8260 List of Volatile Organic Compounds (VOC's) SW-846 (Method 8260B), and the 8270 Target Compound List of Semi-Volatile Organic Compounds (SVOCs) SW-846 (Method 8270).

2.2 Groundwater Sampling and Analysis

Three (3) existing site monitoring wells and six (6) newly installed monitoring wells were selected for groundwater sampling. Groundwater samples were collected from existing off site wells including MW-7A, located near the corner of 10th Avenue and 19th Street; and MW-224, located southeast of the site near the corner of 10th Avenue and 18th Street. These well locations are offsite wells hydrogeologically upgradient from the site. MW-219, located in the sidewalk on the North side of 18th Street near the site building, is considered an offsite well hydrogeologically downgradient from the site. MW-1 through MW-6 are the newly installed wells which are all located on the site. Monitoring well construction detail sheets are included as Appendix C. The monitoring well locations are shown on Figure 6 and Figure 7. Groundwater Contour Plan includes the flow direction based on surveyed elevations and measurements to the top of the water surface. Newly installed wells were developed by removing between 10 and 23 well volumes of water from each well. Well development logs are included as Appendix D. Unfiltered groundwater samples were collected using a peristaltic pump and dedicated tubing. Appendix E contains the well sampling logs.

The groundwater samples were collected in appropriate containers and preserved with the appropriate chemical preservatives as required and placed in a cooler with ice at 4 degrees Celsius prior to and during shipment. Groundwater samples were analyzed for the 8260 List of VOC's by SW-846 (Method 8260B), and the 8270 Target Compound List of SVOCs by SW-846 (Method 8270).

3.0 Investigative Results

The results of the field screening of soil and analytical results of soil and groundwater samples are included in the following sections.

3.1 Soil Description

Soil borings were advanced to a maximum depth of 20 feet bgs. Native subsurface soils were encountered after a layer of typical fill material which is described as brown fine and medium sand with debris including gravel, concrete, brick, glass and wood. The fill material extended from approximately 5 to 20 feet bgs. Native soils were identified after that and were typically brown, fine to medium sand and varying amounts of silt. A silt area was followed by gray clay which was also identified at approximately 19 to 20 feet bgs. Saturated soils were typically encountered from 10 to 12 feet bgs.

The depth of boring, field screening results, and intervals sampled for each of the borings are presented in the Soil Boring Summary Table below.

Soil Boring Summary Table

Soil Boring	Depth of Boring (ft)	Highest PID Screening (ppm)	Description	Interval Sampled feet bgs
SB/MW-1	20	1185	Strong petroleum odor, discoloration/stain	8-9
SB/MW-2	20	98	Petroleum odor, discoloration/stain	8-9
SB/MW-3	20	1485	Odor	6-6.5
SB/MW-4	20	217	Slight petroleum smell	7-8
SB/MW-5	20	1658	Petroleum odor, stained and visible sheen on saturated soil	9-9.5
SB/MW-6	20	795	Some petroleum odor	10-10.5
SB-7	20	348	Some petroleum odor	7-8
SB-8	20	124	Wood debris observed	8-9

3.2 Bedrock Description

Bedrock, reportedly mica schist and quartz feldspar granulite, was not encountered. Bedrock is reportedly located from 60-80 feet bgs in this area based on previous borings.

3.3 Groundwater Description

Monitoring wells were installed as part of this ESI. The depth to water in these wells ranged from approximately 8 to 9.5 feet bgs. Based on surveyed well construction elevation data and water level measurements, groundwater flow is toward the southwest. The monitoring wells installed for sampling are constructed of 2 inch diameter polyvinyl chloride (PVC) wells and had a completed depth of 20 feet bgs. Well construction details are included as Appendix C. Newly installed monitoring wells were developed by purging prior to sampling. Well development logs are included as Appendix D. Sampling procedures included a peristaltic pump with dedicated tubing and the Low-Flow Purging and Sampling Method (LFPS). Sampling logs are included as Appendix E.

3.4 Laboratory Results for Soil Samples

Soil samples were analyzed for the 8260 List of Volatile Organic Compounds (VOC's) SW-846 (Method 8260B), and the 8270 Target Compound List of Semi-Volatile Organic Compounds (SVOCs) SW-846 (Method 8270). The analytical data was compared to the contaminant-specific soil cleanup objectives included in 6NYCRR 375-6.8(a) and 375-6.8(b), if not found then values are taken from the NYSDEC CP-51 /Soil Cleanup Guidance. Appendix D contains the laboratory reports.

3.4.1 Volatile Organic Compounds (VOCs) in Soil

Table 3 of the Attachments summarizes the results and the standards, guidance values (SGV) and Figure 8 Summary of VOCs Detected in Subsurface Soil Plan summarizes the detected compounds and sample locations. The soil sample with the most VOCs detected above the SGVs was SB-3 in which the sample was collected from 6-6.5 feet bgs. A total of eleven (11) VOCs (1,2,4-trimethylbenzene, 1,3,5-trimethylbenzene, acetone, ethylbenzene, methylene chloride, naphthalene, n-propylbenzene, o xylene, p- & m- xylenes, toluene and total xylenes) were detected above the SGVs. However, methylene chloride and toluene were also identified in the associated method blank indicating that the detection may be a laboratory artifact and not an indication of a contaminant in the soil.

The sample from SB-5 indicated a total of three (3) VOCs above SGVs, namely acetone, methylene chloride and n-propylbenzene. Acetone and methylene chloride were the only VOCs identified in soil from SB-1, SB-2 and SB-4 above their SGVs. In the soil sample from SB-6 and SB-7, only acetone was identified above the SGV. Soil from SB-8 did not reveal any VOCs above a SGV.

It should be noted that acetone and methylene chloride are common laboratory artifacts and are often identified in sample analysis and are not indicative of a contaminant in site soil.

3.4.2 Semi Volatile Organic Compounds (SVOCs) in Soil

Table 4 of the Attachments summarizes the results and the SGVs and Figure 9 Summary of SVOCs Detected in Subsurface Soil Plan summarizes the detected compounds and sample locations. The only soil samples with SVOCs detected above the SGVs were from SB-6 and SB-7. The remaining soil samples analyzed did not reveal SVOCs above their respective SGVs. The soil from SB-6 and SB-7 each had benzo(a)anthracene, benzo(a)pyrene, benzo(b)fluoranthene, benzo(k)fluoranthene and chrysene detected above their SGVs and additionally SB-7 also revealed indeno(1,2,3-cd)pyrene above the SGV. SB-6 was collected from 10-10.5 feet bgs and SB-7 was collected from 7-8 feet bgs.

3.5 Laboratory Results for Groundwater Samples

Groundwater samples were analyzed for the 8260 List of VOC's SW-846 (Method 8260B), and the 8270 Target Compound List of SVOCs SW-846 (Method 8270). The analytical data was compared to the contaminant-specific standards or guidance values contained in the NYSDEC Technical and Operation Guidance Series (TOGS 1.1.1). Appendix F contains the laboratory reports.

3.5.1 VOCs in Groundwater

Table 5 summarizes the concentrations of VOCs in groundwater and Figure 10 Summary of VOCs Detected in Groundwater Plan summarizes the detected compounds and sample locations. Six (6) onsite monitoring wells (MW-1 through MW-6) were sampled and analyzed as well three (3) offsite monitoring wells, which included MW-7A and MW-224, which are hydrogeologically upgradient from the site and MW-219 which is hydrogeologically downgradient from the site.

For the upgradient wells, benzene was the only VOC detected above the SGV in MW-7A. A total of five (5) VOCs (benzene, isopropylbenzene, n-butylbenzene, n-propylbenzene, and sec-butylbenzene) were detected in MW-224. VOC's were not detected at levels greater than the SGVs in the downgradient well MW-219

Four (4) VOCs (benzene, isopropylbenzene, methylene chloride and n-propylbenzene) were detected in MW-1 above the SGVs. A total of three (3) VOCs (benzene, isopropylbenzene and n-propylbenzene) were detected in MW-2, MW-5 and MW-6. MW-3 had 1,2,4-trimethylbenzene, benzene, ethylbenzene, o-xylene, and p -m xylene detected above their respective SGVs. Benzene was the only VOC detected above the SGV in MW-4.

Benzene was detected in eight (8) of nine (9) groundwater samples collected and analyzed, including from all upgradient and on site monitoring wells. VOC's, including benzene, were not detected at levels greater than the SGVs in MW-219, the offsite down gradient well.

3.5.2 SVOCs in Groundwater

Table 6 summarizes the concentrations of SVOCs in groundwater analyzed from the site and Figure 11 Summary summarizes the detected compounds and sample locations. SVOC's were not detected at levels greater than the SGVs in MW-3, MW-4, MW-6, MW-219 and MW-7A. In MW-1, MW-2 and MW-5 bis(2-ethylhexyl)phthalate was detected above the SGV and in MW-224 only 2-methylnaphthalene was detected above the SGV.

4.0 Findings, Conclusions and Recommendations

This Limited Phase II Environmental Site Investigation (ESI) Report has been prepared by CORE Environmental, Inc. (CORE) for the property located at 515 West 18th Street, Manhattan, New York. The Phase II ESI was performed by CORE, Aquifer Drilling and Testing which installed the soil borings and monitoring wells as well as York Analytical Laboratories, Inc. which performed the sample analysis. Drilling was completed beginning on January 23rd, 2012 and January 25th through the 27th, 2012. The monitoring well purging and sampling was completed on February 6th, 2012. The investigation revealed the following findings:

- The review of previous completed ESIs indicates that the former gas holders located on the adjacent lot are underlain by areas of MGP waste and MGP impacted fill which provides a constant source of contaminants migrating in the area groundwater upward and throughout the overburden soil in the area.
- Native subsurface soils were encountered after a layer of typical fill material which is described as brown fine and medium sand with debris including gravel, concrete, brick, glass and wood. The native soils were identified between 5 and 11 feet bgs and were typically brown, fine to medium sand and varying amounts of silt. Silt was found to precede a gray clay layer which was identified at approximately 19 to 20 feet bgs. Bedrock was not encountered.
- Groundwater was encountered in soil borings from approximately 8 to 9.5 feet bgs. The groundwater flow direction was determined to be toward the southwest based on surveyed elevations of ten (10) monitoring wells and the measured depth to the groundwater surface.
 - Volatile Organic Compounds (VOC's) were detected above the compound specific guidance values (SGV) in two (2) of the eight (8) soil samples collected. The soil sample collected from soil boring SB-3, located 20 feet to the east of the UST area, a total of nine (9) VOCs were detected above the SGVs. One (1) VOC was detected above the SGV in the soil sample collected from soil boring SB-5, located approximately 40 feet to the west of the UST area. The soil samples collected immediately adjacent to the UST area (SB-8 to the east, SB-7 to the north, SB-4 to the west, and SB-2 to the south) did not exhibit VOC's above SGV's.
 - Semi-volatile organic compounds (SVOC's) were detected above the SGVs in two (2) of the eight (8) soil samples collected, specifically in SB-6 at 10-10.5 feet bgs and SB-7 at 7-8 feet bgs. The soil from SB-6 and SB-7 had five (5) and six (6) SVOCs, respectively above their SGVs. These SVOCs are PAH compounds which are indicative of historic NYC fill which in this area often contains coal tar waste.

- VOC's were detected at levels greater than the SGVs in eight (8) of the nine (9) groundwater samples collected. The only well with no detectable VOCs is located southwest of the site building on the sidewalk. Benzene was detected at levels greater than the SGVs in the eight (8) remaining groundwater samples. Three (3) of these groundwater samples were collected hydraulically upgradient from the UST area while five (5) were collected from monitoring wells hydraulically downgradient from the UST area.
- SVOC's were not detected at levels greater than the SGVs in MW-3, MW-4, MW-6, MW-219 and MW-7A. In MW-1, MW-2, MW-5 and MW-224 one SVOC was detected above its SGV.

Based on the results of this investigation, the highest level of subsurface soil contamination was identified in SB-3 at 6 to 6.5 feet bgs. The other area of subsurface soil contamination resulting from VOCs was located in SB-5 at 9 to 9.5 feet bgs. The location and differing nature of the contaminants detected in these soil borings suggest they do not appear to be connected in a larger area. Evidence of this is that similar compounds were not detected in the soil borings located between these borings. Additionally, the fact that the other borings completed near and in between SB-3 and SB-5 did not show similar exceedances of VOCs indicates the contamination is limited and localized in the vicinity of these soil boring locations. The contamination may be the result of an on or off site source, an upgradient spill, or most likely from contaminated fill material being present on site.

The only soil samples with SVOCs detected above the SGVs were from SB-6 and SB-7. SB-6 was collected from 10-10.5 feet bgs and SB-7 was collected from 7-8 feet bgs. The soil from SB-6 and SB-7 each had benzo(a)anthracene, benzo(a)pyrene, benzo(b)fluoranthene, benzo(k)fluoranthene and chrysene detected above their SGVs and additionally SB-7 also revealed indeno(1,2,3-cd)pyrene above the SGV. These compounds are known as polycyclic aromatic hydrocarbons (PAHs) and are ubiquitous to coal tars. Two (2) additional soil borings (SB-4 and SB-5) were found to be contaminated with PAHs at levels below the SGVs. The location and similar nature of the contaminants detected in these four (4) soil borings suggest the contaminated area may be connected. The contamination is likely from fill material.

The soils borings completed in the vicinity of the location of the USTs (SB-2, SB-3, SB-4, SB-7 and SB-8) did not indicate subsurface soil contamination resulting from the USTs is present. The VOCs and PAHs present in SB-3, an upgradient location from the former USTs were not identified in the other borings at downgradient locations from the UST area. Based upon this data it appears the USTs were properly closed in place and are not presenting a source of site contaminants.

VOC's were not detected at levels greater than the SGVs at the downgradient monitoring well located southwest of the subject site building (MW-219). Benzene was detected in the remaining eight (8) monitoring wells, including at the upgradient well locations (MW-224 and MW-7A). This

indicates that there is and has been a migration of VOCs, especially benzene in the groundwater impacting this site. Benzene is one of the most common compounds associated with MGP residues and is also one of the most soluble VOCs. In MW-4 and MW-7A, benzene was the only VOC detected above the SGV while in MW-2, MW-5 and MW-6 three (3) VOCs were above SGVs and in MW-1, four (4) VOCs were detected above the SGVs. Five (5) VOCs were detected in MW-3 and MW-224 above the SGVs. The highest total VOC concentrations were detected in MW-2, which is located downgradient from the former UST area, indicating the UST contents may have contributed to the site contaminants.

One (1) SVOC, each considered a PAH, was detected above the SGV in three (3) onsite monitoring wells (MW-1, MW-2, MW-5). An additional offsite monitoring well (MW-219) also had one (1) SVOC above the SGV. Three (3) of the wells are located in the sidewalk along the north side of West 18th Street and the fourth is inside the site building. The presence of PAHs in monitoring wells south of the site and adjoining site suggests that they are resulting from localized impacted fill containing MGP wastes.

Conclusions and Recommendations

Based on the findings from previous site investigations, which included soil borings and monitoring wells on the subject site and adjoining site, MGP contamination is present on adjoining sites including Lot 29, which is located immediately upgradient. The contamination is characterized by visible oil-like material, tar-like material, sheen, black staining, and MGP-related odors in the subsurface soil and/or groundwater. Additionally, previous investigations completed onsite and in the vicinity indicated widespread benzene contamination of groundwater.

Borings, monitoring wells and a test pit were placed in the area, including the adjoining site (Lot 29), as part of the 2006 investigation by TRC. MGP evidence was noted in seven (7) soil borings in Area 2 which included three (3) on Lot 29 which identified the MGP evidence in SB-7 (19 to 35 feet bgs), SB-9 (22-26 feet bgs) and SB-11 (21 to 33 feet bgs). Concentrations of one VOC, benzene, in shallow groundwater exceeded the SGVs while SVOCs were not detected in excess of the SGVs. These borings and monitoring wells indicate that MGP waste is present in subsurface soils and benzene in shallow upgradient wells is widespread.

Borings and monitoring wells were placed in the area as part of the 2007 investigation by Arcadis. MGP evidence was noted at three (3) soil boring locations, including SB-MTP-2 (19 feet bgs) which is located on Lot 29. The remaining two (2) locations with MGP evidence were SB-224 (34.5 feet bgs) and SB-272 (15 to 20 feet bgs). SB-224 is located south of Lot 29 near the corner of 18th Street and 10th Avenue while SB-272 is located southwest of the site building on the north side of 18th Street. The concentrations of VOCs, including BTEX, detected in shallow groundwater exceeded the SGV. One VOC, benzene was most frequently present and exceeded the SGV. SVOCs were not detected in excess of the SGVs. These borings and monitoring wells also indicate

that MGP waste is present in subsurface soils and benzene in shallow upgradient wells is widespread.

Furthermore, based on the number of petroleum spills in the area, the impacts from offsite spill sites to the subject site cannot be discounted. There are over 50 reported spill sites located within a ½ mile of the subject site. CORE suspects that the VOCs detected in groundwater (including BTEX) may have migrated onsite through groundwater since many of the spills are located upgradient of the site and not all spills are closed and/or remediated.

Based on the findings of this investigation, VOC's have impacted site soil in the southern area of the site at two (2) discrete localized areas; specifically in the vicinity of SB-3 and SB-5. SVOC's appear to have impacted site soil in the vicinity of SB-6 and SB-7. Similar to previous investigations completed onsite and in the vicinity widespread benzene contamination was identified in groundwater. The only monitoring well which was not contaminated with benzene is located upgradient to the former gas holders.

The USTs located on site may have contributed to the VOC impact to groundwater but the continued migration of VOC contamination from off-site sources is believed to be the primary source of groundwater contamination. The diffusion of benzene from the source material continues to impact the groundwater in the former MGP site area as well as downgradient areas. The previous subsurface investigations completed on the adjoining lot near and beneath the former gas holders consistently identified the highest concentrations of benzene at depths where the former gas holder bottoms were located. In comparison, the upper areas of soil had a much lower benzene concentrations. This conclusion is supported by each of the previously completed subsurface investigative activities which consistently identify the widespread BTEX contamination of soils and groundwater. Each of the investigations identified benzene with the highest frequency of exceedances as well as its widespread nature. Furthermore, this investigation identified the prevalence of benzene in the groundwater, but it was not detected in any soil sample analyzed from the site, even the samples located near the former UST area were absent of benzene.

Understanding that there is a constant source of VOCs migrating through groundwater upward and throughout the overburden in the area from the MGP waste and MGP impacted fill, it is our opinion that minor removal or treatment of localized petroleum affected soil or groundwater will not be effective. This is based on the fact that a constant source of VOCs is located upgradient and below the site and all site USTs have been closed and/or removed and do not represent a source. The findings from previous site investigations indicate that soil and groundwater at the subject site has been contaminated by the former MGP and a contamination source is still present. Therefore, remediation efforts of small localized areas of limited VOCs and/or SVOCs, including PAHs, will be unproductive and unsuccessful until the larger predominant contamination sources from MGP operations have been fully removed and/or remediated.

CORE does not recommend remedial actions at this site. In the event limited subsurface remediation of soil or treatment of groundwater is required then it should be completed as part of site redevelopment activities. Furthermore, CORE recommends no further investigations be completed at the site since the previous site investigations as well as this investigation have defined the nature and extent of petroleum based contamination of subsurface soil and groundwater as well as the probable source.

5.0 Statement of Limitations

The data presented and the opinions expressed in this report are by Qualified Environmental Professionals (QEP) according to the New York State Department of Environmental Conservation (DEC) NYSDEC DER-10 DRAFT Technical Guidance for Site Investigation and Remediation [November 4, 2009]. This guidance provides an overview of the site investigation and remediation process for DEC remedial programs. A QEP is a person, including a firm headed by such person, who possesses sufficient specific education, training, and experience necessary to exercise professional judgment to develop opinions and conclusions regarding the presence of releases or threatened releases to the surface or subsurface of a site or off-site areas, sufficient to meet the objectives and performance factors for the areas of practice identified in the guidance. Furthermore, the data presented and the opinions expressed in this report are qualified as stated in the Appendix to this section of the report. The report was prepared by environmental professionals, which according to the EPA are someone who possesses sufficient specific education, training, and experience necessary to exercise professional judgment to develop opinions and conclusions regarding conditions indicative of releases or threatened releases on, at, in, or to a property. We declare that, to the best of our professional knowledge and belief, we meet the definition of *Environmental professional* as defined in §312.10 of 40 CFR 312" and 12.13.2 we have the specific qualifications based on education, training, and experience to assess a *property* of the nature, history, and setting of the subject *property*. We have developed and performed the all appropriate inquiries in conformance with the standards and practices set forth in 40 CFR Part 312.

Completed by:

Manuel Duran
Environmental Scientist

Vladimir Ortiz
Senior Geologist

Prepared by:

William J. Czelusta, Jr, CHMM
Senior Scientist

Reviewed by:

Ronald P. Tramposch
Project Manager

QA/QC Reviewed by:

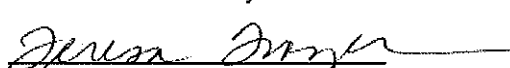
Theresa S. Tramposch
President

Statement of Limitations

The data presented and the opinions expressed in this report are qualified as follows:

1. The sole purpose of the investigation and of this report is to assess the physical characteristics of the Site with respect to the presence or absence in the environment of oil or hazardous materials and substances as defined in the applicable state and federal environmental laws and regulations and to gather information regarding current and past environmental conditions at the Site.
2. Core Environmental, Inc. (Core) derived the data in this report primarily from visual inspections, examination of records in the public domain, interviews with individuals with information about the Site, and a limited number of subsurface explorations made on the dates indicated. The passage of time, manifestation of latent conditions or occurrence of future events may require further exploration at the Site, analysis of the data, and reevaluation of the findings, observations, and conclusions expressed in the report.
3. In preparing this report, Core has relied upon and presumed accurate certain information (or the absence thereof) about the Site and adjacent properties provided by governmental officials and agencies, the Client, and others identified herein. Except as otherwise stated in the report, (Core) has not attempted to verify the accuracy or completeness of any such information.
4. The data reported and the findings, observations, and conclusions expressed in the report are limited by the Scope of Services, including the extent of subsurface exploration and other tests. The Scope of Services was defined by the requests of the Client, the time and budgetary constraints imposed by the Client, and the availability of access to the Site.
5. Because of the limitations stated above, the findings, observations, and conclusions expressed by Core in this report are not, and should not be considered, an opinion concerning the compliance of any past or present owner or operator of the site with any federal, state or local law or regulation. No warranty or guarantee, whether express or implied, is made with respect to the data reported or findings, observations, and conclusions expressed in this report. Further, such data, findings, observations, and conclusions are based solely upon site conditions in existence at the time of investigation.
6. This report has been prepared on behalf of and for the exclusive use of the Client, and is subject to and issued in connection with the Agreement and the provisions thereof.

6.0 References

1. NYSDEC Policy CP-51 / Soil Cleanup Guidance
2. NYSDEC Technical and Operation Guidance Series (TOGS 1.1.1)
3. Tables in 6 NYCRR 375-6.8(a) and 375-6.8(b)
4. *Phase I Environmental Site Assessment (ESA)* by LiRo Engineers, Inc. (LiRo) for 501-513 West 19th Street and 153-159 10th Avenue in Manhattan, New York, dated March, 2005.
5. *A Phase II Limited Subsurface Investigation* was performed by Langan Engineering and Environmental Services, dated November 28, 2011.
6. *A Limited Phase II ESI* by Core for 501-513 West 19th Street and 153-159 10th Avenue in Manhattan, New York, dated September 24, 2007.
7. *Remedial Investigation Report* for the Former West 18th Street Gas Works, Manhattan, New York, VCA Site # V00530-2 by Arcadis, BBL October 2006-March 2007.
8. *A Phase I ESA* by Core at 501-513 West 19th Street and 153-159 10th Avenue in Manhattan, New York dated December 29, 2006.
9. *Site Characterization Study Report* for the Former West 18th Street Gas Works, Manhattan, New York, VCA Site # V00530-2 by TRC Environmental Corporation dated January 2006.
10. *Special West Chelsea Rezoning and High Line Open Space EIS*, New York City Department of City Planning Department 2004 (Chapter 10: Hazardous Materials).
11. *Phase II Site Investigation Report*, West 19th Street Development Site by Blasland, Bouck & Lee, Inc. (BBL) 2003.
12. *Remedial Action Work Plan* West 19th Street Development Site by BBL 2003.
13. *Preliminary Site Investigation Report*, West 19th Street Development Site by BBL 2002.

TABLES

- 1 Summary of VOCs from Previous Investigations
- 2 Summary of SVOCs from Previous Investigations
- 3 Summary of VOCs in Soil
- 4 Summary of SVOCs in Soil
- 5 Summary of VOCs in Groundwater
- 6 Summary of SVOCs in Groundwater

FIGURES

- 1 Site Location Map
- 2 Site Plan and Adjacent Lots
- 3 Historical Manufactured Gas Plant Structures
- 4 Previous Investigations Sample Locations
- 5 Historical Vicinity Spill Sites
- 6 Soil Boring and Monitoring Well Plan
- 7 Groundwater Contour Plan
- 8 Summary of VOCs Detected in Subsurface Soil Plan
- 9 Summary of SVOCs Detected in Subsurface Soil Plan
- 10 Summary of VOCs Detected in Groundwater Plan
- 11 Summary of SVOCs Detected in Groundwater Plan

Summary of VOCs from Previous Investigations

Sample Location: TP2	SGV	Depth (ft): 10-11
Benzene	60	49
Toluene	700	1.9
Ethyl Benzene	1000	
xylenes	260	9.2
Total BTEX (PPB):		60.1

Sample Location: SB-7	SGV	Depth (ft): 6-7	Depth (ft): 17-19	Depth (ft): 27-29	Depth (ft): 43-45
Benzene	60				
Toluene	700				
Ethyl Benzene	1000				
xylenes	260				
Total BTEX (PPB):		0	0	0	0

Sample Location: MW-7A	SGV	Depth (ft): 6-7	In Groundwater
Benzene	60		20
Toluene	700		
Ethyl Benzene	1000		
xylenes	260		
Total BTEX (PPB):		0	20

Sample Location: SB-8	SGV	Depth (ft): 4-5	Depth (ft): 11-11.5	Depth (ft): 14.5-15
Benzene	60		44	11
Toluene	700			
Ethyl Benzene	1000		22	
xylenes	260			
Total BTEX (PPB):		0	66	11

Sample Location: SB-9	SGV	Depth (ft): 4-5	Depth (ft): 8-10	Depth (ft): 20-22	Depth (ft): 26-28	Depth (ft): 32-34
Benzene	60		9.1	880		6.2
Toluene	700		1.7	770		
Ethyl Benzene	1000			9100		11
xylenes	260	4.4		1406.3		3.2
Total BTEX (PPB):		4.4	10.8	12156.3	20.4	0

Sample Location: SB-10	SGV	Depth (ft): 5-6	Depth (ft): 6-8	Depth (ft): 8-10	Depth (ft): 20-22	Depth (ft): 48-50
Benzene	60		4600	7200		64
Toluene	700	2600	74000	37000		33
Ethyl Benzene	1000	7700	53000	24000		49
xylenes	260	56000	350000	127000		276
Total BTEX (PPB):		66300	481600	195200	422	0

Ta 1
Summary of VOCs from Previous Investigations

Sample Location: SB-11	SGV	Depth (ft): 5-6	Depth (ft): 13-15	Depth (ft): 27-29	Depth (ft): 35-37	Depth (ft): 37-39
Benzene	60		1.5	26000	7.3	
Toluene	700			15000	3.1	
Ethyl Benzene	1000	310	1.9	18000		1.5
xylenes	260	2020	15.7	11006.4		1.2
Total BTEX (PPB):		2330	19.1	70006.4	10.4	2.7

Sample Location: SB-14	SGV	Depth (ft): 4-5	Depth (ft): 11-13	Depth (ft): 17-19	Depth (ft): 23-25
Benzene	60				
Toluene	700				
Ethyl Benzene	1000				
xylenes	260	4.4			
Total BTEX (PPB):		4.4	0	0	0

Sample Location: MW-12-A	SGV	In Groundwater
Benzene	60	65
Toluene	700	
Ethyl Benzene	1000	
xylenes	260	
Total BTEX (PPB):		65

Sample Location: MW-12B	SGV	In Groundwater
Benzene	60	1.2
Toluene	700	
Ethyl Benzene	1000	
xylenes	260	
Total BTEX (PPB):		1.2

Sample Location: MTP-1	SGV	Depth (ft): 3-4	Depth (ft): 8-9	Depth (ft): 19-20	Depth (ft): 23-24
Benzene	60	290	310	15	2.8
Ethyl Benzene	700	720	20000	1.2	2
Toluene	1000		3900	3.2	2.3
xylenes	260	3800	110000	7.5	8.4
Total BTEX (PPB):		4810	134210	26.9	15.5

Sample Location: MTP-2	SGV	Depth (ft): 9-10	Depth (ft): 18-19	Depth (ft): 22-23	Depth (ft): 24-25
Benzene	60	0.67	16000	8.8	0.99
Ethyl Benzene	700	5.9	85000	23	5.2
xylenes	1000	0.84	24000	13	2
Toluene	260		230000	76	14
Total BTEX (PPB):		7.41	355000	120.8	22.19

Ta. 1
Summary of VOCs from Previous Investigations

Sample Location: MTP-3	SGV	Depth (ft): 8-9	Depth (ft): 24-24
Benzene	60	6.2	6700
Ethyl Benzene	700	6.2	
Toluene	1000	0.69	270
xylenes	260		
Total BTEX (PPB):		13.09	6970

Sample Location: SB-208	SGV	Depth (ft): 2-3	Depth (ft): 9.5-10	Depth (ft): 19-20
Benzene	60	0.61		860
Ethyl Benzene	700			
Toluene	1000	5.6		
xylenes	260			
Total BTEX (PPB):		6.21	0	860

Sample Location: SB-209	SGV	Depth (ft): 9.4-10	Depth (ft): 11-13	Depth (ft): 19-20
Benzene	60	2.2	21	2100
Ethyl Benzene	700			2400
Toluene	1000			
xylenes	260			2000
Total BTEX (PPB):		2.2	21	6500

Sample Location: SB-210	SGV	Depth (ft): 7-9	Depth (ft): 11-13	Depth (ft): 21-23	Depth (ft): 25-27	Depth (ft): 36-37
Benzene	60	1.1	2.5	44	7.9	6.8
Ethyl Benzene	700			5.1		
Toluene	1000	5.7	6.6	6.3	6.5	6.1
xylenes	260		20	5.8		
Total BTEX (PPB):		6.8	29.1	61.2	14.4	12.9

Sample Location: SB-213	SGV	Depth (ft): 8-9	Depth (ft): 19-20
Benzene	60		21
Ethyl Benzene	700	6.3	12
Toluene	1000	1.8	11
xylenes	260	19	51
Total BTEX (PPB):		27.1	95

Sample Location: SB-214	SGV	Depth (ft): 5-7	Depth (ft): 9.5-10	Depth (ft): 11-13	Depth (ft): 19-20
Benzene	60			2.1	
Ethyl Benzene	700				
Toluene	1000				
xylenes	260				
Total BTEX (PPB):		0	0	2.1	0

Summary of VOCs from Previous Investigations

Sample Location: SB-215	SGV	Depth (ft): 8-10	Depth (ft): 14-16	Depth (ft): 26-28	Depth (ft): 30-32	Depth (ft): 34-36
Benzene	60	1	2.8	9.4	140	4.7
Ethyl Benzene	700				2.1	
Toluene	1000	5.7	6.2	5.8	6.1	5.6
xylenes	260	2020			1.6	
Total BTEX (PPB):		2026.7	9	15.2	149.8	10.3

Sample Location: SB-219	SGV	Depth (ft): 5.5-6	Depth (ft): 10-10.5	Depth (ft): 32-32.5
Benzene	60			
Ethyl Benzene	700			
Toluene	1000			
xylenes	260		3.3	
Total BTEX (PPB):		0	3.3	0

Sample Location: SB-220	SGV	Depth (ft): 7.5-8	Depth (ft): 21-21.5
Benzene	60		
Ethyl Benzene	700		
Toluene	1000		
xylenes	260	130	
Total BTEX (PPB):		130	0

Sample Location: SB-221	SGV	Depth (ft): 2-4	Depth (ft): 6-8	Depth (ft): 9.5-10	Depth (ft): 24-25
Benzene	60			1.4	710
Ethyl Benzene	700				690
Toluene	1000				140
xylenes	260				680
Total BTEX (PPB):		0	0	1.4	2220

Sample Location: SB-222	SGV	Depth (ft): 1-3	Depth (ft): 7.5-8.5	Depth (ft): 15-17	Depth (ft): 19-20
Benzene	60	390	2.1	720	4400
Ethyl Benzene	700	17000	3.8	24	1500
Toluene	1000	1000		6.4	570
xylenes	260	160000	31	73	1300
Total BTEX (PPB):		178390	36.9	823.4	7770

Sample Location: SB-223	SGV	Depth (ft): 12.5-13	Depth (ft): 17.5-18	Depth (ft): 28-28.5	Depth (ft): 32-32.5
Benzene	60				
Ethyl Benzene	700				
Toluene	1000				
xylenes	260				
Total BTEX (PPB):		0	0	0	0

Table 1
Summary of VOCs from Previous Investigations

Sample Location: SB-224	SGV	Depth (ft): 8-8.5	Depth (ft): 34.5-35	Depth (ft): 37.5-38
Benzene	60			
Ethyl Benzene	700		2500	79
Toluene	1000			
xylenes	260		40000	14
Total BTEX (PPB):		0	42500	93

Sample Location: SB-254	SGV	Depth (ft): 8-9	Depth (ft): 19-20
Benzene	60		160
Ethyl Benzene	700		170
Toluene	1000		
xylenes	260		140
Total BTEX (PPB):		0	470

Sample Location: SB-272	SGV	Depth (ft): 7-8	Depth (ft): 16-17	Depth (ft): 24-25
Benzene	60		8300	
Ethyl Benzene	700	620	1600	32
Toluene	1000			
xylenes	260	1700	1900	100
Total BTEX (PPB):		2320	11800	132

Sample Location: SB-273	SGV	Depth (ft): 9-10	Depth (ft): 24-25	Depth (ft): 29-30
Benzene	60			
Ethyl Benzene	700			
Toluene	1000			
xylenes	260			
Total BTEX (PPB):		0	0	0

Summary of SVOCs from Previous Investigations

TP2	SGV	Depth (ft): 10-11
Naphthalene	12,000	
Benzo(a)anthracene	1000	
Chrysene	1000	
Benzo(b+k)fluoranthene	1800	
Benzo(a)pyrene	1000	
Total SVOC (PPB):		0

Sample Location: SB-7	SGV	Depth (ft): 6-7	Depth (ft): 17-19	Depth (ft): 27-29	Depth (ft): 43-45
Naphthalene	12,000				
Benzo(a)anthracene	1000				
Chrysene	1000				
Benzo(b+k)fluoranthene	1800				
Benzo(a)pyrene	1000		0	0	0
Total SVOC (PPB):		0	0	0	0

Sample Location: MW-7A	In Groundwater
Naphthalene	
Benzo(a)anthracene	
Chrysene	
Benzo(b+k)fluoranthene	
Benzo(a)pyrene	
Total SVOC (PPB):	0

Sample Location: SB-8	SGV	Depth (ft): 4-5	Depth (ft): 11-11.5	Depth (ft): 14-14.5
Naphthalene	12,000			
Benzo(a)anthracene	1000			
Chrysene	1000			
Benzo(b+k)fluoranthene	1800			
Benzo(a)pyrene	1000		0	0
Total SVOC (PPB):		0	0	0

Sample Location: SB-9	SGV	Depth (ft): 4-5	Depth (ft): 8-10	Depth (ft): 20-22	Depth (ft): 26-28	Depth (ft): 32-34
Naphthalene	12,000		44	94000	780	75
Benzo(a)anthracene	1000	190	290	2900	39	6.2
Chrysene	1000	280	260	2500	50	13
Benzo(b+k)fluoranthene	1800	460	420	3500	33	36
Benzo(a)pyrene	1000	240	260	2000	6.5	7.1
Total SVOC (PPB):		1170	1274	104900	908.5	137.3

Summary of SVOCs from Previous Investigations

Sample Location: SB-10	SGV	Depth (ft): 5-6	Depth (ft): 6-8	Depth (ft): 8-10	Depth (ft): 20-22	Depth (ft): 48-50
Naphthalene	12,000	9100	9200	4000	5600	8.6
Benzo(a)anthracene	1000	2700	1600	57	68	6
Chrysene	1000	2300	1200	120	75	13
Benzo(b+k)fluoranthene	1800	3900	2200	630	69	5
Benzo(a)pyrene	1000	2400	1200	65	49	6.8
Total SVOC (PPB):		20400	15400	4872	5861	39.4

Sample Location: SB-11	SGV	Depth (ft): 5-6	Depth (ft): 13-15	Depth (ft): 27-29	Depth (ft): 35-37	Depth (ft): 37-39
Naphthalene	12,000	2400	8.6	1300000	280	8.6
Benzo(a)anthracene	1000	2000	6	16000	6	13
Chrysene	1000	1800	13	13000	13	9.1
Benzo(b+k)fluoranthene	1800	3030	35	17200	34	35
Benzo(a)pyrene	1000	1700	6.8	11000	6.8	6.8
Total SVOC (PPB):		10930	69.4	1357200	339.8	72.5

Sample Location: SB-14	SGV	Depth (ft): 4-5	Depth (ft): 11-13	Depth (ft): 17-19	Depth (ft): 23-25
Naphthalene	12,000	520	41		
Benzo(a)anthracene	1000	1000			
Chrysene	1000	1100			
Benzo(b+k)fluoranthene	1800	2100			
Benzo(a)pyrene	1000	1300			
Total SVOC (PPB):		6020	41	0	0

Sample Location: MW-12-A	SGV	In Groundwater
Naphthalene	12,000	
Benzo(a)anthracene	1000	
Chrysene	1000	
Benzo(b+k)fluoranthene	1800	
Benzo(a)pyrene	1000	
Total SVOC (PPB):		0

Sample Location: MW-12B	SGV	In Groundwater
Naphthalene	12,000	
Benzo(a)anthracene	1000	
Chrysene	1000	
Benzo(b+k)fluoranthene	1800	
Benzo(a)pyrene	1000	
Total SVOC (PPB):		0

Ta. 1
Summary of SVOCs from Previous Investigations

Sample Location: MTP-1	SGV	Depth (ft): 3-4	Depth (ft): 8-9	Depth (ft): 19-20	Depth (ft): 23-24
Naphthalene	12,000	610	5500	3900	
Benzo(a)anthracene	1000	490	390	480	
Chrysene	1000	490	340	430	
Benzo(b+k)fluoranthene	1800	830	450	630	
Benzo(a)pyrene	1000	530	280	360	
Total SVOC (PPB):		2950	6960	5800	0

Sample Location: MTP-2	SGV	Depth (ft): 9-10	Depth (ft): 18-19	Depth (ft): 22-23	Depth (ft): 24-25
Naphthalene	12,000	520	22000000	720	540
Benzo(a)anthracene	1000	180	46000	360	
Chrysene	1000	250	47000	360	
Benzo(b+k)fluoranthene	1800	360	61000		
Benzo(a)pyrene	1000	190	35000		
Total SVOC (PPB):		1500	22189000	1440	540

Sample Location: MTP-3	SGV	Depth (ft): 8-9	Depth (ft): 24-24
Naphthalene	12,000		
Benzo(a)anthracene	1000		
Chrysene	1000		
Benzo(b+k)fluoranthene	1800		
Benzo(a)pyrene	1000		
Total SVOC (PPB):		0	0

Sample Location: SB-208	SGV	Depth (ft): 2-3	Depth (ft): 9.5-10	Depth (ft): 19-20
Naphthalene	12,000	150		
Benzo(a)anthracene	1000	1200	130	
Chrysene	1000	1200	130	
Benzo(b+k)fluoranthene	1800	2300	590	
Benzo(a)pyrene	1000	1300	140	
Total SVOC (PPB):		6150	990	0

Sample Location: SB-209	SGV	Depth (ft): 9.4-10	Depth (ft): 11-13	Depth (ft): 19-20
Naphthalene	12,000			290
Benzo(a)anthracene	1000			120
Chrysene	1000			120
Benzo(b+k)fluoranthene	1800			290
Benzo(a)pyrene	1000			140
Total SVOC (PPB):		0	0	960

Summary of SVOCs from Previous Investigations

Sample Location: SB-210	SGV	Depth (ft): 7-9	Depth (ft): 11-13	Depth (ft): 21-23	Depth (ft): 25-27	Depth (ft): 36-37
Naphthalene	12,000	160	86	59		
Benzo(a)anthracene	1000	440				
Chrysene	1000	510				
Benzo(b+k)fluoranthene	1800	600				
Benzo(a)pyrene	1000	500				
Total SVOC (PPB):		2210	86	59	0	0

Sample Location: SB-213	SGV	Depth (ft): 8-9	Depth (ft): 19-20
Naphthalene	12,000	4600	
Benzo(a)anthracene	1000	1200	
Chrysene	1000	1800	740
Benzo(b+k)fluoranthene	1800	3000	
Benzo(a)pyrene	1000	1100	
Total SVOC (PPB):		11700	740

Sample Location: SB-214	SGV	Depth (ft): 5-7	Depth (ft): 9.5-10	Depth (ft): 11-13	Depth (ft): 19-20
Naphthalene	12,000				58
Benzo(a)anthracene	1000	760	71		
Chrysene	1000	70			
Benzo(b+k)fluoranthene	1800	230			
Benzo(a)pyrene	1000	160			
Total SVOC (PPB):		1220	71	0	58

Sample Location: SB-215	SGV	Depth (ft): 8-10	Depth (ft): 14-16	Depth (ft): 26-28	Depth (ft): 30-32
Naphthalene	12,000	270	77	350	
Benzo(a)anthracene	1000	1300	440	2900	
Chrysene	1000	1400	470	3000	
Benzo(b+k)fluoranthene	1800	2600	1470	3000	
Benzo(a)pyrene	1000	1200	430	2500	
Total SVOC (PPB):		6770	2887	11750	0

Sample Location: SB-219	SGV	Depth (ft): 5.5-6	Depth (ft): 10-10.5	Depth (ft): 32-32.5
Naphthalene	12,000	140		
Benzo(a)anthracene	1000	67		
Chrysene	1000	75		
Benzo(b+k)fluoranthene	1800	89		
Benzo(a)pyrene	1000	71		
Total SVOC (PPB):		442	0	0

Summary of SVOCs from Previous Investigations

Sample Location: SB-220	SGV	Depth (ft): 7-8-8	Depth (ft): 21-21.5
Naphthalene	12,000		
Benzo(a)anthracene	1000	180	
Chrysene	1000	220	
Benzo(b+k)fluoranthene	1800	150	
Benzo(a)pyrene	1000	120	
Total SVOC (PPB):		670	0

Sample Location: SB-221	SGV	Depth (ft): 2-4	Depth (ft): 6-8	Depth (ft): 9.5-10	Depth (ft): 24-25
Naphthalene	12,000	190			
Benzo(a)anthracene	1000	6000			
Chrysene	1000	58000			
Benzo(b+k)fluoranthene	1800	129000			
Benzo(a)pyrene	1000	8400			
Total SVOC (PPB):		201590	0	0	0

Sample Location: SB-222	SGV	Depth (ft): 1-3	Depth (ft): 7.5-8.5	Depth (ft): 15-17
Naphthalene	12,000	2000	130	99
Benzo(a)anthracene	1000	590		
Chrysene	1000	730		
Benzo(b+k)fluoranthene	1800	1950		
Benzo(a)pyrene	1000	1400		
Total SVOC (PPB):		6670	130	99

Sample Location: SB-223	SGV	Depth (ft): 12.5-13	Depth (ft): 17.5-18	Depth (ft): 28-28.5	Depth (ft): 32-32.5
Naphthalene	12,000				
Benzo(a)anthracene	1000				
Chrysene	1000				
Benzo(b+k)fluoranthene	1800				
Benzo(a)pyrene	1000				
Total SVOC (PPB):		0	0	0	0

Sample Location: SB-224	SGV	Depth (ft): 8-8.5	Depth (ft): 34.5-35	Depth (ft): 37.5-38
Naphthalene	12,000		410000	590
Benzo(a)anthracene	1000	400	160000	430
Chrysene	1000	560	140000	380
Benzo(b+k)fluoranthene	1800	580	245000	230
Benzo(a)pyrene	1000	280	120000	310
Total SVOC (PPB):		1820	1075000	1940

Summary of SVOCs from Previous Investigations

Sample Location: SB-254	SGV	Depth (ft): 8-9	Depth (ft): 19-20
Naphthalene	12,000		130
Benzo(a)anthracene	1000		
Chrysene	1000		
Benzo(b+k)fluoranthene	1800		
Benzo(a)pyrene	1000	0	130
Total SVOC (PPB):			

Sample Location: SB-272	SGV	Depth (ft): 7-8	Depth (ft): 16-17	Depth (ft): 24-25
Naphthalene	12,000	950	98000	540
Benzo(a)anthracene	1000	300	21000	150
Chrysene	1000	280	18000	130
Benzo(b+k)fluoranthene	1800	470	103000	
Benzo(a)pyrene	1000	300	16000	120
Total SVOC (PPB):		2300	256000	940

Sample Location: SB-273	SGV	Depth (ft): 9-10	Depth (ft): 24-25	Depth (ft): 29-30
Naphthalene	12,000			
Benzo(a)anthracene	1000	140		
Chrysene	1000	290		
Benzo(b+k)fluoranthene	1800			
Benzo(a)pyrene	1000	430	0	0
Total SVOC (PPB):				

515 West 18TH Street
Subsurface Soil Sample Results - VOC's

Sample ID:	NYSDEC 375-6.8(a),(b) ^A Protection of GW * CP-51 ^B	515W18 SB-1 1/23/12 8' - 9'	515W18 SB-2 1/23/12 8' - 9'	515W18 SB-3 1/25/12 6' - 6.5'	515W18 SB-4 1/27/12 7' - 8'	515W18 SB-5 1/26/12 9' - 9.5'	515W18 SB-6 1/26/12 10' - 10.5'	515W18 SB-7 1/27/12 7' - 8'	515W18 SB-8 1/27/12 8' - 9'
Date Sampled:									
Sample Depth (ftbgs):									
CONTAMINANT									
<i>Shaded numbers exceed soil cleanup objectives (SCO)</i>									
1,1,1,2-Tetrachloroethane	NE	ND	ND	ND	ND	ND	ND	ND	ND
1,1,1-Trichloroethane	680	ND	ND	ND	ND	ND	ND	ND	ND
1,1,2,2-Tetrachloroethane	600*	ND	ND	ND	ND	ND	ND	ND	ND
1,1,2-Trichloroethane	NE	ND	ND	ND	ND	ND	ND	ND	ND
1,1-Dichloroethane	270	ND	ND	ND	ND	ND	ND	ND	ND
1,1-Dichloroethene	330	ND	ND	ND	ND	ND	ND	ND	ND
1,1-Dichloropropene	NE	ND	ND	ND	ND	ND	ND	ND	ND
1,2,3-Trichlorobenzene	NE	ND	ND	ND	ND	ND	ND	ND	ND
1,2,3-Trichloropropane	340*	ND	ND	ND	ND	ND	ND	ND	ND
1,2,3-Trimethylbenzene	NE	ND	ND	ND	ND	ND	ND	ND	ND
1,2,4-Trichlorobenzene	3,400*	ND	ND	ND	ND	ND	ND	ND	ND
1,2,4-Trimethylbenzene	3,600	ND	ND	49,000	130 J	ND	ND	11 J	ND
1,2-Dibromo-3-dichloropropane	NE	ND	ND	ND	ND	ND	ND	ND	ND
1,2-Dibromoethane	NE	ND	ND	ND	ND	ND	ND	ND	ND
1,2-Dichlorobenzene	1,110	ND	ND	ND	ND	ND	ND	ND	ND
1,2-Dichloroethane	20	ND	ND	ND	ND	ND	ND	ND	ND
1,2-Dichloropropane	NE	ND	ND	ND	ND	ND	ND	ND	ND
1,3,5-Trimethylbenzene	8,400	ND	ND	18,000	ND	ND	ND	ND	ND
1,3-Dichlorobenzene	2,400	ND	ND	ND	ND	ND	ND	ND	ND
1,3-Dichloropropane	NE	ND	ND	ND	ND	ND	ND	ND	ND
1,4-Dichlorobenzene	1,800	ND	ND	ND	ND	ND	ND	ND	ND
2,2-Dichloropropane	NE	ND	ND	ND	ND	ND	ND	ND	ND
2-Chlorotoluene	NE	ND	ND	ND	ND	ND	ND	ND	ND
4-Chlorotoluene	NE	ND	ND	ND	ND	ND	ND	ND	ND
Acetone	50	1,100	770 J	1,600 J	840 J	4,200 J	140	160	21 J,B
Benzene	60	ND	ND	ND	ND	ND	26 J	ND	ND
Bromobenzene	NE	ND	ND	ND	ND	ND	ND	ND	ND
Bromochloromethane	NE	ND	ND	ND	ND	ND	ND	ND	ND
Bromodichloromethane	NE	ND	ND	ND	ND	ND	ND	ND	ND
Bromoform	NE	ND	ND	ND	ND	ND	ND	ND	ND
Bromomethane	NE	690	480 J	ND	610	ND	ND	ND	ND
Carbon Tetrachloride	760	ND	ND	ND	ND	ND	ND	ND	ND
Chlorobenzene	1,100	ND	ND	ND	ND	ND	ND	ND	ND
Chloroethane	1,900*	ND	ND	ND	ND	ND	ND	ND	ND
Chloroform	370	ND	ND	ND	ND	ND	ND	ND	ND
Chloromethane	NE	ND	ND	ND	ND	ND	ND	ND	ND

515 West 18TH Street
Subsurface Soil Sample Results - VOC's

Sample ID:	NYSDEC 375-6.8(a),(b) ^A Protection of GW * CP-51 ^B (ppb)	515W18 SB-1 1/23/12 8' - 9'	515W18 SB-2 1/23/12 8' - 9'	515W18 SB-3 1/25/12 6' - 6.5'	515W18 SB-4 1/27/12 7' - 8'	515W18 SB-5 1/26/12 9' - 9.5'	515W18 SB-6 1/26/12 10' - 10.5'	515W18 SB-7 1/27/12 7' - 8'	515W18 SB-8 1/27/12 8' - 9'
Date Sampled:									
Sample Depth (ftbgs):									
CONTAMINANT									
<i>Shaded numbers exceed soil cleanup objectives (SCO)</i>									
cis-1,3Dichloropropylene	NE	ND	ND	ND	ND	ND	ND	ND	ND
Dibromochloromethane	NE	ND	ND	ND	ND	ND	ND	ND	ND
Dibromomethane	NE	ND	ND	ND	ND	ND	ND	ND	ND
Dichlorodifluoromethane	NE	ND	ND	ND	ND	ND	ND	ND	ND
Ethylbenzene	1,000	ND	7,400	ND	ND	ND	11 J	ND	ND
Hexachlorobutadiene	NE	ND	ND	ND	ND	ND	ND	ND	ND
Isopropylbenzene	NE	ND	2,300	140 J	4,900	110	ND	ND	ND
Methylene Chloride	50	690 J,B	620 J,B	1,200 J,B	570 J,B	3,000 J,B	6.2 B-Dil J,B	62 J,B	15 J,B
MTBE	930	ND	ND	ND	ND	ND	ND	ND	ND
Napthalene (v)	12,000	ND	20,000	ND	ND	ND	ND	11 J	ND
n-Butylbenzene	12,000	570	250 J	5,900	440 J	3,900	63	9.5 J	ND
n-Propylbenzene	3,900	ND	98 J	5,500	150 J	7,100	120	ND	ND
o Xylene	260	ND	ND	20,000	ND	ND	ND	ND	ND
p- & m- Xylenes	260	ND	ND	48,000	200 J	ND	128 J	10 J	ND
p-Isopropyltoluene	10,000	ND	ND	1,300 J	ND	ND	25 J	ND	ND
sec-Butylbenzene	11,000	960	110 J	1,400	360 J	3,000	69	ND	ND
Styrene	NE	ND	ND	ND	ND	ND	ND	ND	ND
tert-Butylbenzene	5,900	ND	ND	ND	ND	ND	ND	ND	ND
Tetrachloroethene	1,300	ND	ND	ND	ND	ND	ND	ND	ND
Toluene	700	ND	ND	1,200 J,B	ND	ND	19 J	ND	ND
trans-1,3 Dichloropropylene	NE	ND	ND	ND	ND	ND	ND	ND	ND
Trichloroethylene	470	ND	ND	ND	ND	ND	ND	ND	ND
Trichlorofluoromethane	NE	ND	ND	ND	ND	ND	ND	ND	ND
Vinyl Chloride	20	ND	ND	ND	ND	ND	ND	ND	ND
Xylenes, Total	260	ND	ND	68,000	200 J	ND	28 J	ND	ND
Total Concentration		4,010.00	2,328.00	250,800.00	3,640.00	26,100.00	645.20	103.50	36.00

Volatiles - 8260 List - Method SW846-8260

J = Detected below the reporting limit but greater than or equal to the Method Detection Limit (MDL), therefore the result is an estimated concentration

B = Analyte is found in the associated analysis batch blank. For volatiles, methylene chloride and acetone are common lab contaminants Data users should consider anything <10x the blank value as an artifact

B-Dil = Detected in method blank(s) associated with sample analysis. This is a common lab artifact which is found at ND-25 ppb. No dilution factor has been applied to these compounds to eliminate artificially inflated results

NE = Not Established

ND = Not Detected

(A) Restricted, Unrestricted use values shown were derived from the final human-health based SCOs, the groundwater SCOs and the ecological SCOs. The lowest of these values was selected as the final SCO, unless a corresponding rural soil background concentration was higher, in which case the lowest rural soil background concentration was selected as the final SCO. If the final SCO was lower than the CRQL for a chemical the CRQL was substituted as the final SCO.

(B) Contaminant-specific soil cleanup objectives for contaminants not included in Tables 375-6.8(a) and 375-6.8(b) are taken from CP-51 /Soil Cleanup Guidance.

515 West 18TH Street
Subsurface Soil Sample Results - SVOC's

Sample ID:	NYSDEC 375-6.8(a),(b) ^A Protection of GW * CP-51 ^B (ppb)	515W18 SB-1 1/23/12 8' - 9'	515W18 SB-2 1/23/12 8' - 9'	515W18 SB-3 1/25/12 6' - 6.5'	515W18 SB-4 1/27/12 7' - 8'	515W18 SB-5 1/26/12 9' - 9.5'	515W18 SB-6 1/26/12 10' - 10.5'	515W18 SB-7 1/27/12 7' - 8'	515W18 SB-8 1/27/12 8' - 9'
Date Sampled:									
Sample Depth (ftbgs):									
CONTAMINANT									
1,2,4-Trichlorobenzene(sv)	3,400*	ND	ND	ND	ND	ND	ND	ND	ND
1,2-Dichlorobenzene(sv)	1,100	ND	ND	ND	ND	ND	ND	ND	ND
1,3-Dichlorobenzene(sv)	2,400	ND	ND	ND	ND	ND	ND	ND	ND
1,4-Dichlorobenzene(sv)	1,800	ND	ND	ND	ND	ND	ND	ND	ND
2,4,5-Trichlorophenol	3,800	ND	ND	ND	ND	ND	ND	ND	ND
2,4,6-Trichlorophenol	NE	ND	ND	ND	ND	ND	ND	ND	ND
2,4-Dichlorophenol	400*	ND	ND	ND	ND	ND	ND	ND	ND
2,4-Dimethylphenol	NE	ND	ND	ND	ND	ND	ND	ND	ND
2,4-Dinitrophenol	200*	ND	ND	ND	ND	ND	ND	ND	ND
2,4-Dinitrotoluene	NE	ND	ND	ND	ND	ND	ND	ND	ND
2,6-Dinitrotoluene	1000*	ND	ND	ND	ND	ND	ND	ND	ND
2-Chloronaphthalene	NE	ND	ND	ND	ND	ND	ND	ND	ND
2-Chlorophenol	800*	ND	ND	ND	ND	ND	ND	ND	ND
2-Methylnaphthalene	36,400*	ND	ND	15,100	ND	3,480	ND	ND	ND
2-Methylphenol (o-cresol)	100*	ND	ND	ND	ND	ND	ND	ND	ND
2-Nitroaniline	430*	ND	ND	ND	ND	ND	ND	ND	ND
2-Nitrophenol	330*	ND	ND	ND	ND	ND	ND	ND	ND
3,3'-Dichlorobenzidine	NE	ND	ND	ND	ND	ND	ND	ND	ND
3-Methylphenol	NE	ND	ND	ND	ND	ND	ND	ND	ND
3-Nitroaniline	500*	ND	ND	ND	ND	ND	ND	ND	ND
4,6-Dinitro-2-methylphenol	NE	ND	ND	ND	ND	ND	ND	ND	ND
4-Bromophenyl phenyl ether	NE	ND	ND	ND	ND	ND	ND	ND	ND
4-Chloro-3-methylphenol	240*	ND	ND	ND	ND	ND	ND	ND	ND
4-Chloroaniline	220*	ND	ND	ND	ND	ND	ND	ND	ND
4-Chlorophenyl phenyl ether	NE	ND	ND	ND	ND	ND	ND	ND	ND
4-Methylphenol (p-cresol)	900*	ND	ND	ND	ND	ND	ND	ND	ND
4-Nitroaniline	NE	ND	ND	ND	ND	ND	ND	ND	ND
4-Nitrophenol	100*	ND	ND	ND	ND	ND	ND	ND	ND
Acenaphthene	50,000*	ND	ND	ND	ND	439	ND	ND	ND
Acenaphthylene	41,000*	ND	ND	ND	ND	ND	ND	ND	ND
Aniline	100	ND	ND	ND	ND	ND	ND	ND	ND
Anthracene	50,000*	ND	262	ND	ND	233	250	1670 J	ND
Benzo(a)anthracene	1,000	ND	ND	ND	82.4 J	172 J	2,330	6,360	ND
Benzo(a)pyrene	1,000	ND	ND	ND	113 J	138 J	2,660	6,630	ND
Benzo(b)fluoranthene	1,000	ND	ND	ND	85.4 J	137 J	1,490	5,260	ND
Benzo(ghi)perylene	100,000	ND	ND	ND	62.9 J	ND	316	1,420	ND
Benzo(k)fluoranthene	800	ND	ND	ND	95.7 J	114 J	1,810	6,150	ND
Benzyl Alcohol	NE	ND	ND	ND	ND	ND	ND	ND	ND

515 West 18TH Street
Subsurface Soil Sample Results - SVOC's

Sample ID:	NYSDEC 375-6.8(a),(b) ^A Protection of GW * CP-51 ^B	515W18 SB-1 1/23/12 8' - 9'	515W18 SB-2 1/23/12 8' - 9'	515W18 SB-3 1/25/12 6' - 6.5'	515W18 SB-4 1/27/12 7' - 8'	515W18 SB-5 1/26/12 9' - 9.5'	515W18 SB-6 1/26/12 10' - 10.5'	515W18 SB-7 1/27/12 7' - 8'	515W18 SB-8 1/27/12 8' - 9'
Date Sampled:									
Sample Depth (ftbgs):									
CONTAMINANT									
<i>Shaded numbers exceed soil cleanup objectives (SCO)</i>									
Bis(2-chloroethoxy)methane	NE	ND	ND	ND	ND	ND	ND	ND	ND
Bis(2-chloroethyl)ether	NE	ND	ND	ND	ND	ND	ND	ND	ND
Bis(2-chloroisopropyl)ether	NE	ND	ND	ND	ND	ND	ND	ND	ND
Bis(2-ethylhexyl)phthalate	50,000*	ND	ND	ND	896	95.2 J	ND	190	150 J
Butyl Benzyl Phthalate	50,000*	ND	ND	ND	ND	ND	389	ND	ND
Chrysene	1,000	ND	ND	ND	90.7 J	277	1,750	5,690	ND
Dibenz(a,h)anthracene	330	ND	ND	ND	ND	ND	283	ND	ND
Dibenzofuran	7,000	ND	ND	ND	ND	ND	ND	ND	ND
Diethyl Phthalate	7,100*	ND	ND	ND	ND	ND	ND	ND	ND
Dimethyl Phthalate	2,000*	ND	ND	ND	ND	ND	ND	ND	ND
Di-n-Butyl Phthalate	8,100*	ND	ND	ND	ND	ND	ND	ND	ND
Di-n-octyl Phthalate	50,000*	ND	ND	ND	ND	ND	ND	ND	ND
Fluoranthene	100,000	146 J	115 J	ND	ND	672	1,880	9,580	ND
Fluorene	30,000	ND	853	ND	ND	ND	71.5 J	ND	ND
Hexachlorobenzene	330	ND	ND	ND	ND	ND	ND	ND	ND
Hexachlorobutadiene	NE	ND	ND	ND	ND	ND	ND	ND	ND
Hexachlorocyclopentadiene	NE	ND	ND	ND	ND	ND	ND	ND	ND
Hexachloroethane	NE	ND	ND	ND	ND	ND	ND	ND	ND
Indeno(1,2,3-cd)pyrene	500	ND	ND	ND	ND	ND	459	1,960 J	ND
Isophorone	4,400*	ND	ND	ND	ND	ND	ND	ND	ND
Naphthalene(sv)	12,000	215	393	8,480	ND	ND	116 J	ND	ND
Nitrobenzene	200*	ND	ND	ND	ND	ND	ND	ND	ND
N-Nitrosodi-n-propylamine	NE	ND	ND	ND	ND	ND	ND	ND	ND
N-Nitrosodiphenylamine	NE	ND	ND	ND	ND	ND	ND	ND	ND
Pentachlorophenol (ms)	800	ND	ND	ND	ND	ND	ND	ND	ND
B = Analyte is found in the asso	100,000	ND	1,560	1,820 J	ND	1,700	754	5,240	ND
Phenol	330	ND	ND	ND	ND	ND	ND	ND	ND
Pyrene	100,000	139	244	ND	114 J	652	2,170	6,840	ND
Pyridine	NE	ND	ND	ND	ND	ND	ND	ND	ND
Total Concentration		500	3,427	25,400	15,401	81,092	16,729	56,800	150

Semi-Volatiles (BNAs) - 8270 List - Method SW846-8270C

J = Detected below the reporting limit but greater than or equal to the Method Detection Limit (MDL), therefore the result is an estimated concentration

NE = Not Established

ND = Not Detected

(A) Restricted, Unrestricted use values shown were derived from the final human-health based SCOs, the groundwater SCOs and the ecological SCOs. The lowest of these values was selected as the final SCO, unless a corresponding rural soil background concentration was higher, in which case the lowest rural soil background concentration was selected as the final SCO. If the final SCO was lower than the CRQL for a chemical the CRQL was substituted as the final SCO.

(B) Contaminant-specific soil cleanup objectives for contaminants not included in Tables 375-6.8(a) and 375-6.8(b) are taken from CP-51 /Soil Cleanup Guidance.

515 West 18TH Street
Groundwater Sample Results - VOC's

Sample ID:	NYSDEC Div of Water TOGS 1.1.1	515W18 MW-1	515W18 MW-2	515W18 MW-3	515W18 MW-4	515W18 MW-5	515W18 MW-6	515W18 MW-219	515W18 MW-224	515W18 MW-7A
Date Sampled:	2/6/12	2/6/12	2/6/12	2/6/12	2/6/12	2/6/12	2/6/12	2/6/12	2/6/12	2/6/12
CONTAMINANT	(ppb)	Shaded numbers exceed standard or guidance value								
1,1,1,2-Tetrachloroethane	5	ND	ND	ND	ND	ND	ND	ND	ND	ND
1,1,1-Trichloroethane	5	ND	ND	ND	ND	ND	ND	ND	ND	ND
1,1,2,2 Tetrachloroethane	5	ND	ND	ND	ND	ND	ND	ND	ND	ND
1,1,2-Trichloroethane	1	ND	ND	ND	ND	ND	ND	ND	ND	ND
1,1-Dichloroethane	5	ND	ND	ND	ND	ND	ND	ND	ND	ND
1,1-Dichloroethylene	5	ND	ND	ND	ND	ND	ND	ND	ND	ND
1,1-Dichloropropylene	5	ND	ND	ND	ND	ND	ND	ND	ND	ND
1,2,3 Trichlorobenzene	5	ND	ND	ND	ND	ND	ND	ND	ND	ND
1,2,3-Trichloropropane	5	ND	ND	ND	ND	ND	ND	ND	ND	ND
1,2,4-Trichlorobenzene	5	ND	ND	ND	ND	ND	ND	ND	ND	ND
1,2,4-Trimethylbenzene	5	ND	0.94 J	8.2	ND	ND	1.1 J	ND	1.2 J	ND
1,2-Dibromo-3-dichloropropane	NE	ND	ND	ND	ND	ND	ND	ND	ND	ND
1,2-Dibromoethane	NE	ND	ND	ND	ND	ND	ND	ND	ND	ND
1,2-Dichlorobenzene	3	ND	ND	ND	ND	ND	ND	ND	ND	ND
1,2-Dichloroethane	0.6	ND	ND	ND	ND	ND	ND	ND	ND	ND
1,2-Dichloropropane	1	ND	ND	ND	ND	ND	ND	ND	ND	ND
1,3,5-Trimethylbenzene	5	ND	ND	2.9 J	ND	ND	ND	ND	ND	ND
1,3-Dichlorobenzene	3	ND	ND	ND	ND	ND	ND	ND	ND	ND
1,3-Dichloropropane	5	ND	ND	ND	ND	ND	ND	ND	ND	ND
1,4-Dichlorobenzene	3	ND	ND	ND	ND	ND	ND	ND	ND	ND
2,2-Dichloropropane	5	ND	ND	ND	ND	ND	ND	ND	ND	ND
2-Chlorotoluene	5	ND	ND	ND	ND	ND	ND	ND	ND	ND
4-Chlorotoluene	5	ND	ND	ND	ND	ND	ND	ND	ND	ND
Acetone	50	ND	ND	ND	ND	ND	7.3 J.B	ND	ND	8.2 J.B
Benzene	1	50	350	120	83	30	16	32	23	23
Bromobenzene	5	ND	ND	ND	ND	ND	ND	ND	ND	ND
Bromochloromethane	5	ND	ND	ND	ND	ND	ND	ND	ND	ND
Bromodichloromethane	50	ND	ND	ND	ND	ND	ND	ND	ND	ND
Bromoform	50	ND	ND	ND	ND	ND	ND	ND	ND	ND
Bromomethane	5	ND	ND	ND	ND	ND	ND	ND	ND	ND
Carbon Tetrachloride	5	ND	ND	ND	ND	ND	ND	ND	ND	ND
Chlorobenzene	5	ND	ND	ND	ND	ND	ND	ND	ND	ND
Chloroethane	5	ND	ND	ND	ND	ND	ND	ND	ND	ND
Chloroform	7	ND	ND	ND	ND	ND	ND	ND	ND	ND
Chloromethane	5	ND	ND	ND	ND	ND	ND	ND	ND	ND
cis-1,2 Dichloroethylene		ND	ND	ND	ND	ND	ND	ND	ND	ND
cis-1,3 Dichloropropylene	0.4	ND	ND	ND	ND	ND	ND	ND	ND	ND

515 West 18TH Street
Groundwater Sample Results - VOC's

Sample ID:	NYSDEC	515W18	515W18	515W18	515W18	515W18	515W18	515W18	515W18	515W18	515W18	515W18	515W18
Date Sampled:	Div of Water	MW-1	MW-2	MW-3	MW-4	MW-5	MW-6	MW-219	MW-224	MW-7A			
TOGS 1.1.1	TOGS 1.1.1	2/6/12	2/6/12	2/6/12	2/6/12	2/6/12	2/6/12	2/6/12	2/6/12	2/6/12	2/6/12	2/6/12	2/6/12
CONTAMINANT	(ppb)	Shaded numbers exceed standard or guidance value											
Dibromochloromethane	50	ND	ND	ND	ND	ND	ND	ND	ND	ND	ND	ND	ND
Dibromomethane	5	ND	ND	ND	ND	ND	ND	ND	ND	ND	ND	ND	ND
Dichlorodifluoromethane	NE	ND	ND	ND	ND	ND	ND	ND	ND	ND	ND	ND	ND
Ethylbenzene	5	ND	1.6 J	8	3.4 J	2.5 J	2.2 J	ND	ND	ND	ND	ND	ND
Hexachlorobutadiene	0.5	ND	ND	ND	ND	ND	ND	ND	ND	ND	ND	ND	ND
Isopropylbenzene	5	24 J	10	2 J	1.6 J	6.1	11	21	21	11	21	21	87 J
MTBE	10	ND	9.6	6.2	5.6	3.6 J	7	ND	ND	7	ND	ND	ND
Methylene Chloride	5	44 J.B	4.3 J.B	4 J.B	4.3 J.B	3.5 J.B	3.4 J.B	ND	2.3 J.B	3.4 J.B	ND	2.3 J.B	4.6 J.B
Naphthalene (V)	10	ND	2.6 J	5.2 J	2 J	1.4 J	1.8 J	ND	4.9 J	1.8 J	ND	4.9 J	ND
n-Butylbenzene	5	ND	ND	.91 J	ND	1.6 J	2.4 J	ND	6.3	2.4 J	ND	6.3	ND
n-Propylbenzene	5	22 J	11	1.9 J	ND	6.3	10	39	39	10	39	39	ND
o-Xylene	5	ND	1.2 J	7.9	1.9 J	1.6 J	1.4 J	ND	1.2 J	1.4 J	ND	1.2 J	ND
p-m Xylene	5	ND	4.1 J	17	2.7 J	1.6 J	1.9 J	ND	3.2 J	1.9 J	ND	3.2 J	ND
p-Isopropyltoluene	NE	ND	ND	ND	ND	ND	5.4	ND	ND	5.4	ND	ND	ND
sec-Butylbenzene	5	ND	1.8 J	ND	ND	1.8 J	3.4 J.B	ND	5.2	3.4 J.B	ND	5.2	ND
Styrene	5	ND	ND	ND	ND	ND	ND	ND	ND	ND	ND	ND	ND
tert-Butylbenzene	5	ND	ND	ND	ND	ND	ND	ND	ND	ND	ND	ND	ND
Tetrachloroethylene		ND	ND	ND	ND	ND	ND	ND	ND	ND	ND	ND	ND
Toluene	5	ND	1.5 J	1.3 J	ND	ND	0.93 J	ND	2.3 J	0.93 J	ND	2.3 J	ND
trans-1,2 Dichloroethylene		ND	ND	ND	ND	ND	ND	ND	ND	ND	ND	ND	ND
trans-1,3 Dichloropropylene	0.4	ND	ND	ND	ND	ND	ND	ND	ND	ND	ND	ND	ND
Trichloroethylene	5	ND	ND	ND	ND	ND	ND	ND	ND	ND	ND	ND	ND
Trichlorofluoromethane	5	ND	ND	ND	ND	ND	ND	ND	ND	ND	ND	ND	ND
Vinyl Chloride	2	ND	ND	ND	ND	ND	ND	ND	ND	ND	ND	ND	ND
Xylenes, Total		ND	5.3 J	25	4.7 J	3.2 J	3.2 J	ND	4.4 J	3.2 J	ND	4.4 J	ND
Total Concentration		140	403.94	210.51	103.6	63.3	78.43	5.9	123	78.43	5.9	123	36.67

Volatiles - 8260 List - Method SW846-8260

NE = Not Established

ND = Not Detected

B = Analyte is found in the associated analysis batch blank. For volatiles, methylene chloride and acetone are common lab contaminants. Data users should consider anything <10x the blank value as an artifact

B- Analyte is found in the associated analysis batch blank. For volatiles, methylene chloride and acetone are common lab contaminants. Data user should consider anything <10x the blank value as artifact.

NYSDEC Technical and Operational Guidance Series (TOGS) 1.1.1 Ambient Water Quality Class GA Standards or Guidance Values.

515 West 18TH Street
Groundwater Sample Results - SVOC's

Sample ID:	NYSDEC Div of Water TOGS 1.1.1 (ppb)	515W18 MW-1 GW 2/6/12	515W18 MW-2 GW 2/6/12	515W18 MW-3 GW 2/6/12	515W18 MW-4 GW 2/6/12	515W18 MW-5 GW 2/6/12	515W18 MW-6 GW 2/6/12	515W18 MW-219 GW 2/6/12	515W18 MW-224 GW 2/6/12	515W18 MW-7A GW 2/6/12	
Date Sampled:		Shaded numbers exceed standard or guidance value									
CONTAMINANT											
1,2,4-Trichlorobenzene(sv)	1	ND	ND	ND	ND	ND	ND	ND	ND	ND	
1,2-Dichlorobenzene(sv)	3	ND	ND	ND	ND	ND	ND	ND	ND	ND	
1,3-Dichlorobenzene(sv)	3	ND	ND	ND	ND	ND	ND	ND	ND	ND	
1,4-Dichlorobenzene(sv)	3	ND	ND	ND	ND	ND	ND	ND	ND	ND	
2,4,5-Trichlorophenol	NE	ND	ND	ND	ND	ND	ND	ND	ND	ND	
2,4,6-Trichlorophenol	NE	ND	ND	ND	ND	ND	ND	ND	ND	ND	
2,4-Dichlorophenol	5	ND	ND	ND	ND	ND	ND	ND	ND	ND	
2,4-Dimethylphenol	50	ND	ND	ND	ND	ND	ND	ND	ND	ND	
2,4-Dinitrophenol	10	ND	ND	ND	ND	ND	ND	ND	ND	ND	
2,4-Dinitrotoluene	5	ND	ND	ND	ND	ND	ND	ND	ND	ND	
2,6-Dinitrotoluene	0.07	ND	ND	ND	ND	ND	ND	ND	ND	ND	
2-Chloronaphthalene	10	ND	ND	ND	ND	ND	ND	ND	ND	ND	
2-Chlorophenol	NE	ND	ND	ND	ND	ND	ND	ND	ND	ND	
2-Methylnaphthalene	4.7	ND	ND	ND	ND	ND	ND	ND	ND	ND	
2-Methylphenol (o-cresol)	NE	ND	ND	ND	ND	ND	ND	ND	ND	ND	
2-Nitroaniline	5	ND	ND	ND	ND	ND	ND	ND	ND	ND	
2-Nitrophenol	NE	ND	ND	ND	ND	ND	ND	ND	ND	ND	
3,3'-Dichlorobenzidine	5	ND	ND	ND	ND	ND	ND	ND	ND	ND	
3-Methylphenol	NE	ND	ND	ND	ND	ND	ND	ND	ND	ND	
3-Nitroaniline	5	ND	ND	ND	ND	ND	ND	ND	ND	ND	
4,6-Dinitro-2-methylphenol	NE	ND	ND	ND	ND	ND	ND	ND	ND	ND	
4-Bromophenyl phenyl ether	NE	ND	ND	ND	ND	ND	ND	ND	ND	ND	
4-Chloro-3-methylphenol	NE	ND	ND	ND	ND	ND	ND	ND	ND	ND	
4-Chloroaniline	5	ND	ND	ND	ND	ND	ND	ND	ND	ND	
4-Chlorophenyl phenyl ether	NE	ND	ND	ND	ND	ND	ND	ND	ND	ND	
4-Methylphenol (p-cresol)	NE	ND	ND	ND	ND	ND	ND	ND	ND	ND	
4-Nitroaniline	5	ND	ND	ND	ND	ND	ND	ND	ND	ND	
4-Nitrophenol	NE	ND	ND	ND	ND	ND	ND	ND	ND	ND	
Acenaphthene	20	ND	ND	ND	ND	ND	ND	ND	ND	ND	
Acenaphthylene	NE	ND	ND	ND	ND	ND	ND	ND	ND	ND	
Aniline	5	ND	ND	ND	ND	ND	ND	ND	ND	ND	
Anthracene	50	ND	ND	ND	ND	ND	ND	ND	ND	ND	
Benzo(a)anthracene	5	ND	ND	ND	ND	ND	ND	ND	ND	ND	
Benzo(a)pyrene	0.002	ND	ND	ND	ND	ND	ND	ND	ND	ND	
Benzo(b)fluoranthene	ND	ND	ND	ND	ND	ND	ND	ND	ND	ND	
Benzo(g,h,i)perylene	0.002	ND	ND	ND	ND	ND	ND	ND	ND	ND	
Benzo(k)fluoranthene	NE	ND	ND	ND	ND	ND	ND	ND	ND	ND	
	0.002	ND	ND	ND	ND	ND	ND	ND	ND	ND	

515 West 18TH Street
Groundwater Sample Results - SVOC's

Sample ID:	NYSDEC Div of Water TOGS 1.1.1 (ppb)	515W18 MW-1 GW 2/6/12	515W18 MW-2 GW 2/6/12	515W18 MW-3 GW 2/6/12	515W18 MW-4 GW 2/6/12	515W18 MW-5 GW 2/6/12	515W18 MW-6 GW 2/6/12	515W18 MW-219 GW 2/6/12	515W18 MW-224 GW 2/6/12	515W18 MW-7A GW 2/6/12	
CONTAMINANT		Shaded numbers exceed standard or guidance value									
Benzyl Alcohol	NE	ND	ND	ND	ND	ND	ND	ND	ND	ND	
Bis(2-chloroethoxy)methane	5	ND	ND	ND	ND	ND	ND	ND	ND	ND	
Bis(2-chloroethyl)ether	1	ND	ND	ND	ND	ND	ND	ND	ND	ND	
Bis(2-chloroisopropyl)ether	NE	ND	ND	ND	ND	ND	ND	ND	ND	ND	
Bis(2-ethylhexyl)phthalate	5	16	634	ND	ND	58.2	ND	ND	ND	ND	
Butyl Benzyl Phthalate	50	ND	ND	ND	ND	ND	ND	ND	ND	ND	
Chrysene	0.002	ND	ND	ND	ND	ND	ND	ND	ND	ND	
Dibenz(a,h)anthracene	NE	ND	ND	ND	ND	ND	ND	ND	ND	ND	
Dibenzofuran	NE	ND	ND	ND	ND	ND	ND	ND	ND	ND	
Diethyl Phthalate	50	ND	ND	ND	ND	ND	ND	ND	ND	ND	
Dimethyl Phthalate	50	ND	ND	ND	ND	ND	ND	ND	ND	ND	
Di-n-Butyl Phthalate	50	ND	ND	ND	ND	ND	ND	ND	ND	ND	
Di-n-octyl Phthalate	50	ND	ND	ND	ND	ND	ND	ND	ND	ND	
Fluoranthene	50	ND	ND	ND	ND	ND	ND	ND	ND	ND	
Fluorene	50	ND	ND	ND	ND	ND	ND	ND	ND	ND	
Hexachlorobenzene	0.04	ND	ND	ND	ND	ND	ND	ND	ND	ND	
Hexachlorobutadiene	0.5	ND	ND	ND	ND	ND	ND	ND	ND	ND	
Hexachlorocyclopentadiene	5	ND	ND	ND	ND	ND	ND	ND	ND	ND	
Hexachloroethane	5	ND	ND	ND	ND	ND	ND	ND	ND	ND	
Indeno(1,2,3-cd)pyrene	0.002	ND	ND	ND	ND	ND	ND	ND	ND	ND	
Isophorone	50	ND	ND	ND	ND	ND	ND	ND	ND	ND	
Naphthalene(sv)	10	ND	ND	ND	ND	ND	ND	ND	ND	ND	
Nitrobenzene	0.4	ND	ND	ND	ND	ND	ND	ND	ND	ND	
N-Nitrosodi-n-propylamine	NE	ND	ND	ND	ND	ND	ND	ND	ND	ND	
N-Nitrosodiphenylamine	NE	ND	ND	ND	ND	ND	ND	ND	ND	ND	
Pentachlorophenol (ms)	NE	ND	ND	ND	ND	ND	ND	ND	ND	ND	
B = Analyte is found in the associa	50	ND	ND	ND	ND	ND	ND	ND	ND	ND	
Phenol	1	ND	ND	ND	ND	ND	ND	ND	ND	ND	
Pyrene	50	ND	ND	ND	ND	ND	ND	ND	ND	ND	
Pyridine	50	ND	ND	ND	ND	ND	ND	ND	ND	ND	
Total Concentration		16.00	634.00	0.00	0.00	58.20	0.00	0.00	17.80	0.00	

Semi-Volatiles (BNAs) - 8270 List - Method SW846-8270

J- Detected below the Reporting limit but greater than or equal to the Method Detection Limit; therefore, the result is estimated concentration.
 B- Analyte is found in the associated analysis batch blank. For volatiles, methylene chloride and acetone are common lab contaminants. Data user should consider anything <10x the blank value as artifact.

ND = Not Detected
 NE = Not Established
 NYSDEC Technical and Operational Guidance Series (TOGS) 1.1.1 Ambient Water Quality Class
 GA Standards or Guidance Values.

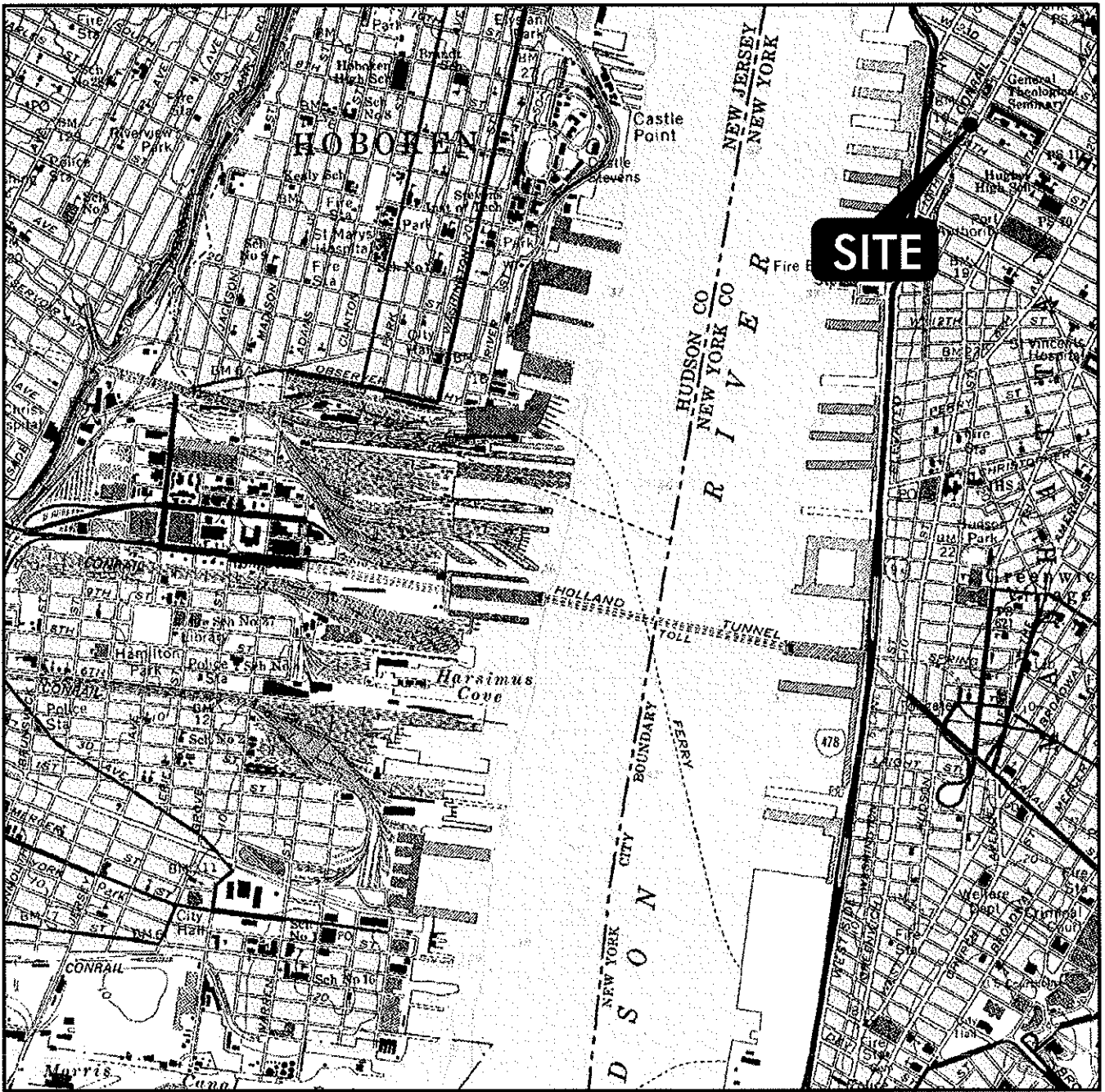

QUADRANGLE LOCATION



SCALE: 1" = 2000'



515 West 18th Street
New York, New York 10011

SITE LOCATION MAP



46-11 54TH AVENUE
MASPETH, N.Y. 11378
T: 718-762-0544
F: 718-762-0545

2312 WEHRLE DRIVE
BUFFALO, N.Y. 14221
T: 716-204-8054
F: 716-204-8557

DATE
03/07/2012

DRAWING No.

1

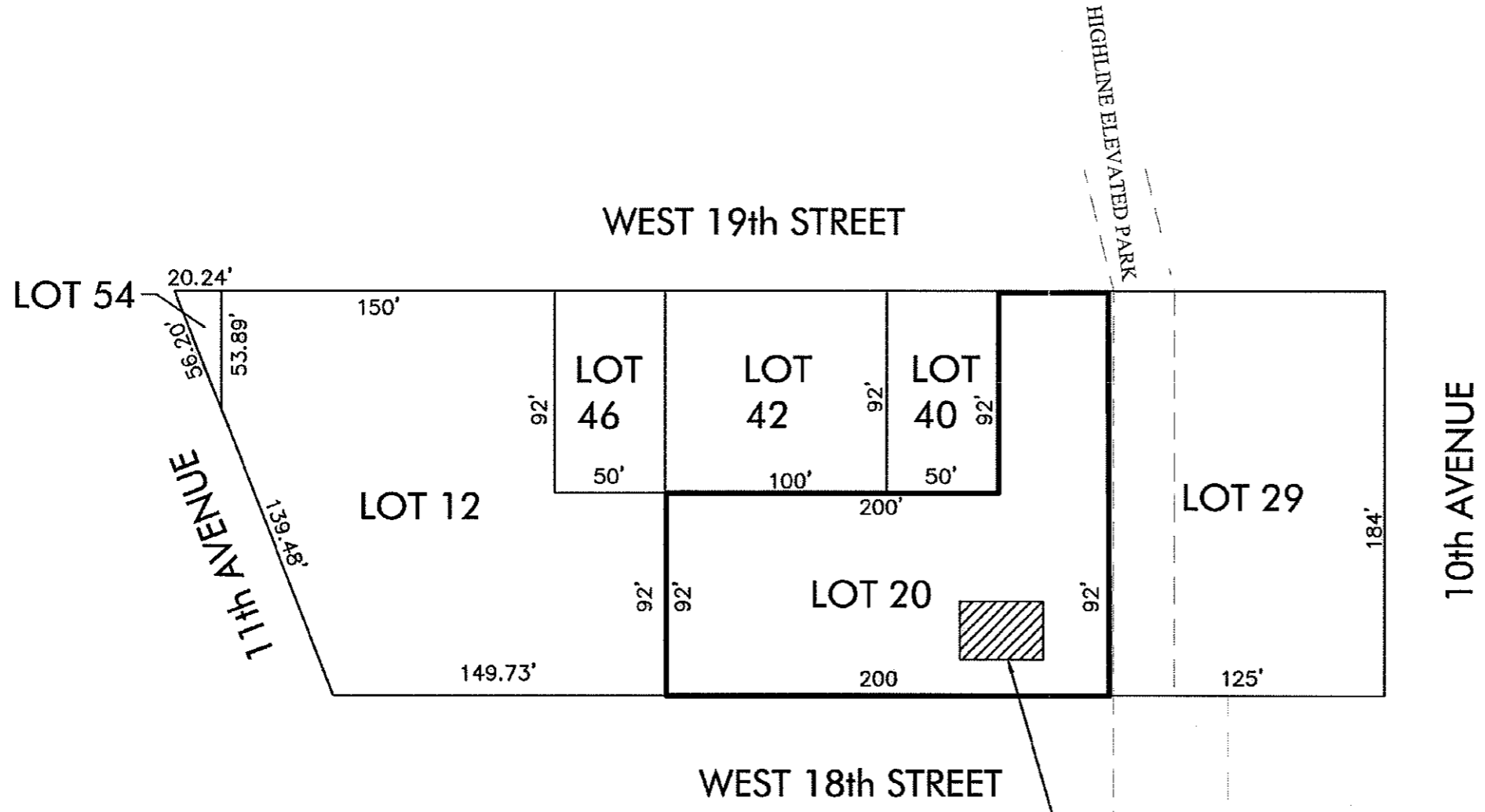
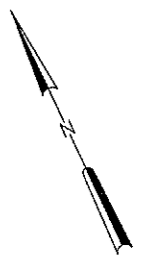

2 - 1,500 GALLON DIESEL TANKS
(REMOVED 1/97)
1 - 4,000 GALLON DIESEL TANK
(CLOSED IN-PLACE 2004)



UST AREAS

JOB TITLE AND LOCATION
515 WEST 18th STREET
NEW YORK, NY 10011

CORE ENVIRONMENTAL
 46-11 54TH AVENUE
 MASPEETH, N.Y. 11378
 T: 718-762-8544
 F: 718-762-0545
 www.COREenv.com

2312 WEHRLE DRIVE
 BUFFALO, N.Y. 14221
 T: 716-204-8054
 F: 716-204-8557

DRAWING TITLE			DRAWING NO. 2
SITE LOCATION AND ADJACENT LOTS			
DATE MARCH 7, 2012	JOB NO. 515-18	SCALE N.T.S.	
DESIGNED BY EMM	CHECKED BY RPT	SHEET 2 OF 11	
DRAWN BY EMM	DATE PLOTTED RPT		

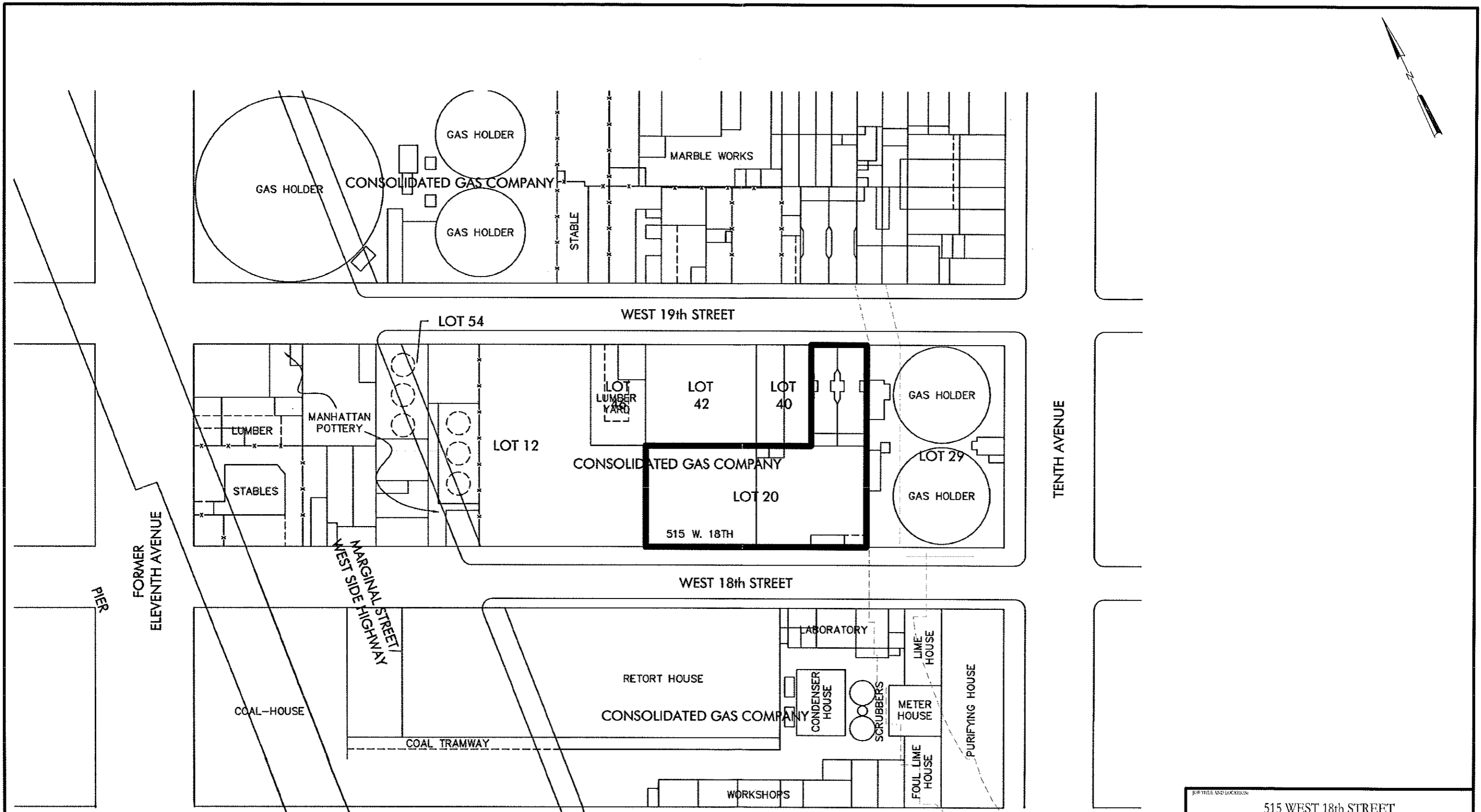
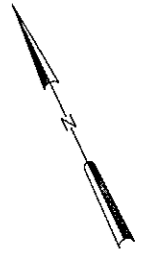

515 WEST 18th STREET
 NEW YORK, NY 10011

CORE ENVIRONMENTAL
 46-11 54TH AVENUE
 MASPEETH, N.Y. 11378
 T: 718-762-0544
 F: 718-762-0545
 www.COREenv.com

2312 WEHRLE DRIVE
 BUFFALO, N.Y. 14221
 T: 716-204-8054
 F: 716-204-8557

DATE: MARCH 7, 2012		JOB NO.: 515-18		DRAWING NO.: 3
DESIGNED BY: EMM	CHECKED BY: RPT	SCALE: N.T.S.		
DRAWN BY: EMM	PROJECT: RPT	SHEET 3 OF 11		

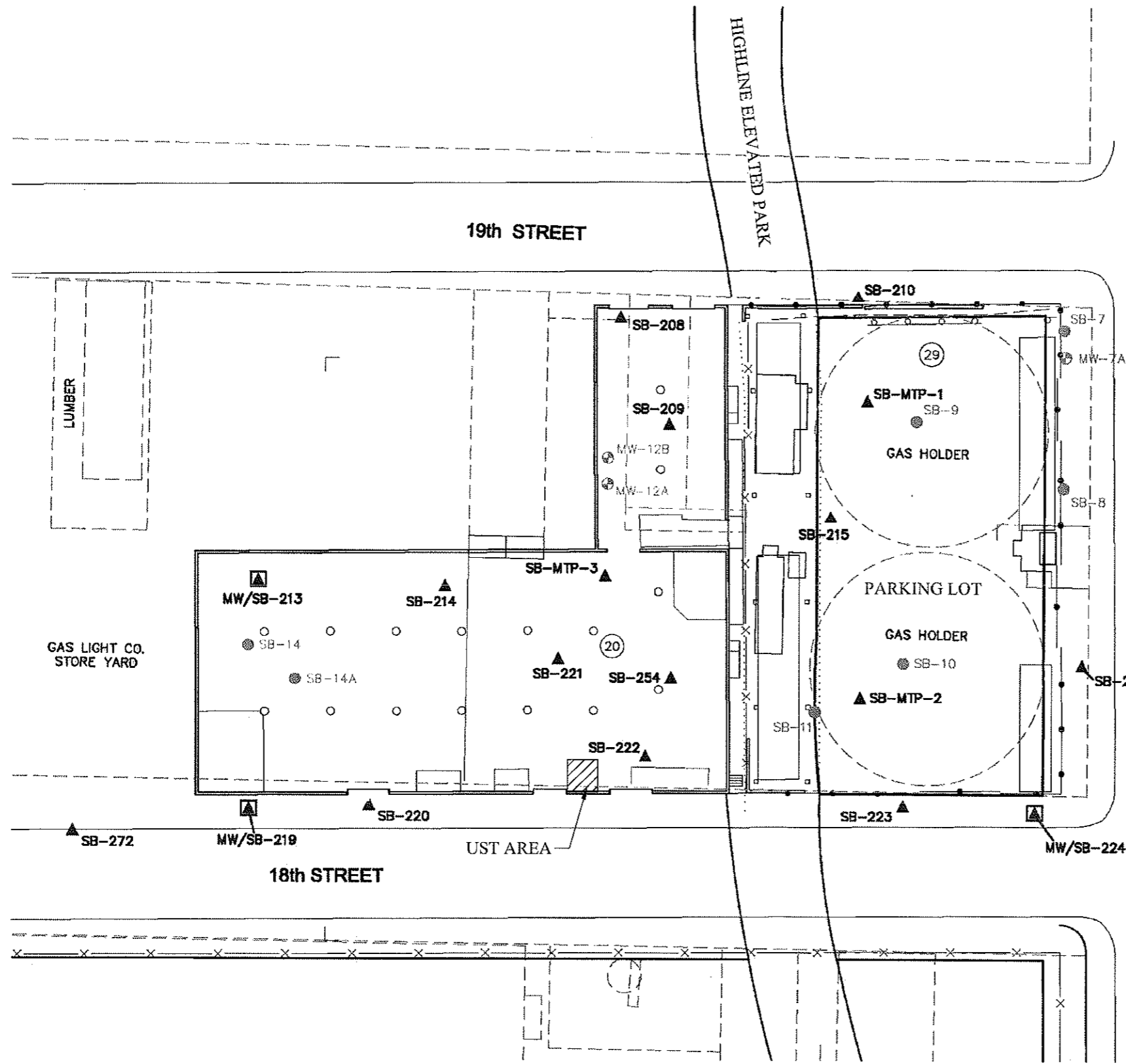
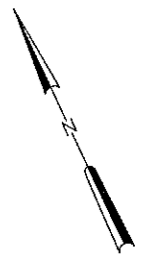

- LEGEND:
- ▲ COMPLETED RI SOIL BORING LOCATION (CON ED)
 - ▲ COMPLETED RI MONITORING WELL LOCATION (CON ED)
 - SCS TEST PIT LOCATION TP- (CON ED)
 - SCS SOIL BORING LOCATION SB- (CON ED)
 - ⊕ SCS MONITORING WELL LOCATION MW- (CON ED)
 - - - HISTORIC FEATURES
 - BUILDING COLUMN

NOTES:

1. BASE MAP FROM TRC'S JANUARY 2006 SITE CHARACTERIZATION STUDY.

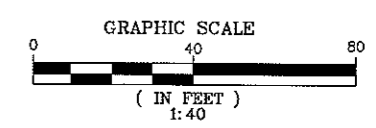

515 WEST 18th STREET
NEW YORK, NY 10011

CORE ENVIRONMENTAL

46-31 54TH AVENUE
MASPETH, N.Y. 11378
T: 718-762-0544
F: 718-762-0545

2312 WEHRLIE DRIVE
BUFFALO, N.Y. 14221
T: 716-204-8034
F: 716-204-8557

www.COREenv.com

DATE: MARCH 7, 2012				SUBJECT: 515-18		DRAWING NO.:	
DESIGNED BY: EMM		PREPARED BY: RPT		SCALE: 1:40		4	
DRAWN BY: EMM		PROJ. ENG.: RPT		SHEET: 4 OF 11			

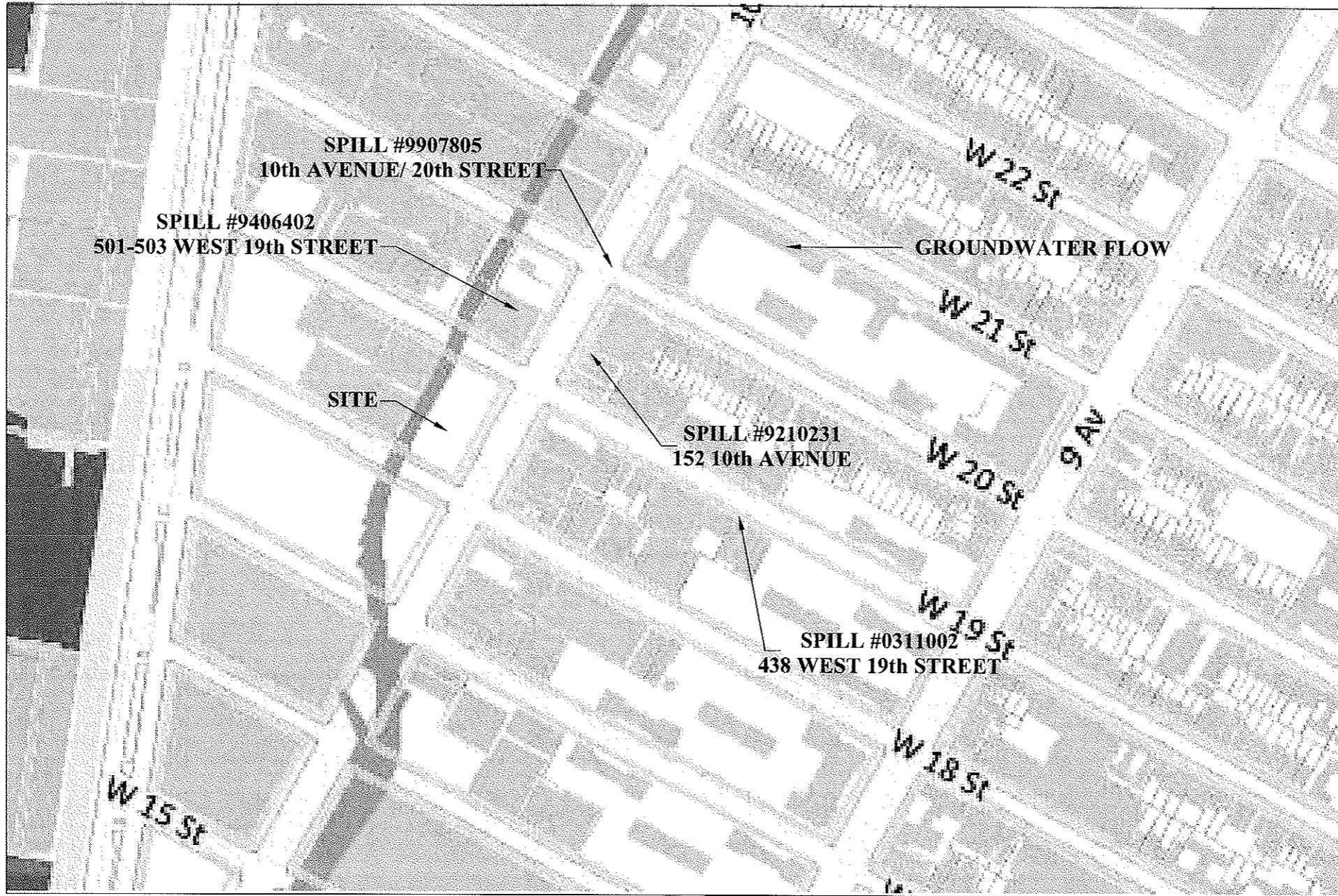
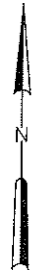

JOB TITLE AND LOCATION:
 515 WEST 18th STREET
 NEW YORK, NY 10011

CORE ENVIRONMENTAL
 46-31 54TH AVENUE MASPETH, N.Y. 11378
 T: 718-762-8544 F: 718-762-0545
 2312 WEIRLE DRIVE BUFFALO, N.Y. 14221
 T: 716-204-8054 F: 716-204-8557
 www.COREenv.com

DRAWING TITLE: HISTORICAL VICINITY SPILL SITES		JOB NO.: 515-18		DRAWING NO.: 5
DATE: MARCH 7, 2012	DESIGNED BY: EMM	CHECKED BY: RPT	SCALE: N.T.S.	
DRAWN BY: EMM	PROJ ENG: RPT	SHEET 5	OF 11	

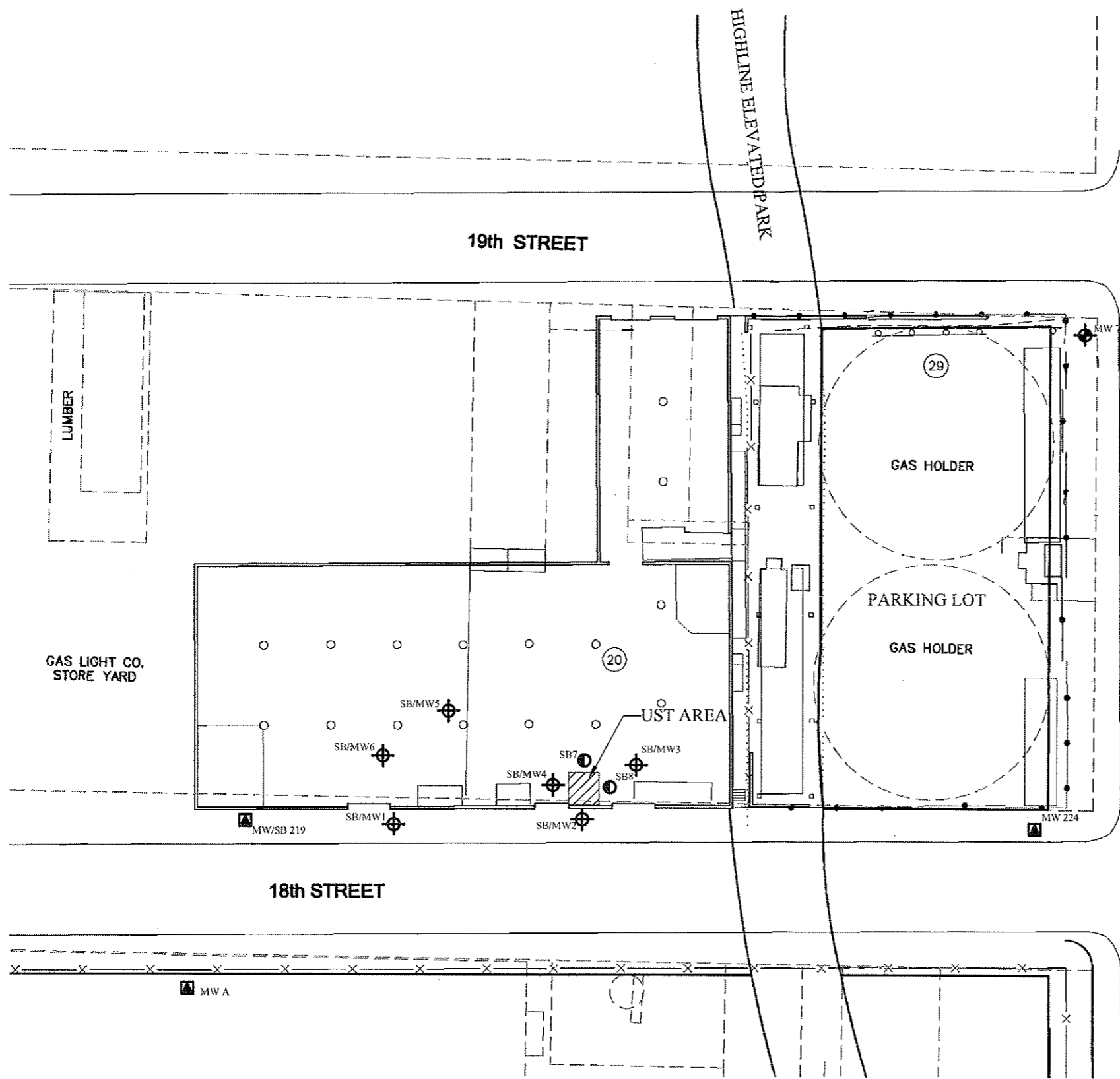
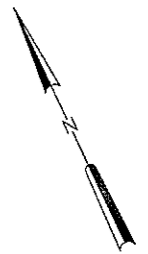

LEGEND:

- SOIL BORING (CORE)
- SOIL BORING/MONITORING WELL (CORE)
- MONITORING WELL (ARCADIS)
- MONITORING WELL (TRC)

NOTES:

1. BASE MAP FROM TRC'S JANUARY 2006 SITE CHARACTERIZATION STUDY.

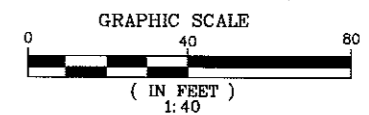

JOB TITLE AND LOCATION:			
515 WEST 18th STREET NEW YORK, NY 10011			
DRAWING TITLE:			
SOIL BORING AND MONITORING WELL PLAN			
DATE:	MARCH 7, 2012	JOB NO.:	515-18
DESIGNED BY:	EMM	SCALE:	1:40
DRAWN BY:	EMM	PROJ. ENG.:	RPT
		SHEET:	6 OF 11
			6

CORE ENVIRONMENTAL

46-11 54TH AVENUE
MASPETH, N.Y. 11378
T: 718-762-0544
F: 718-762-0545

2312 WEHRLE DRIVE
BUFFALO, N.Y. 14221
T: 716-204-8054
F: 716-204-8557

www.COREenv.com

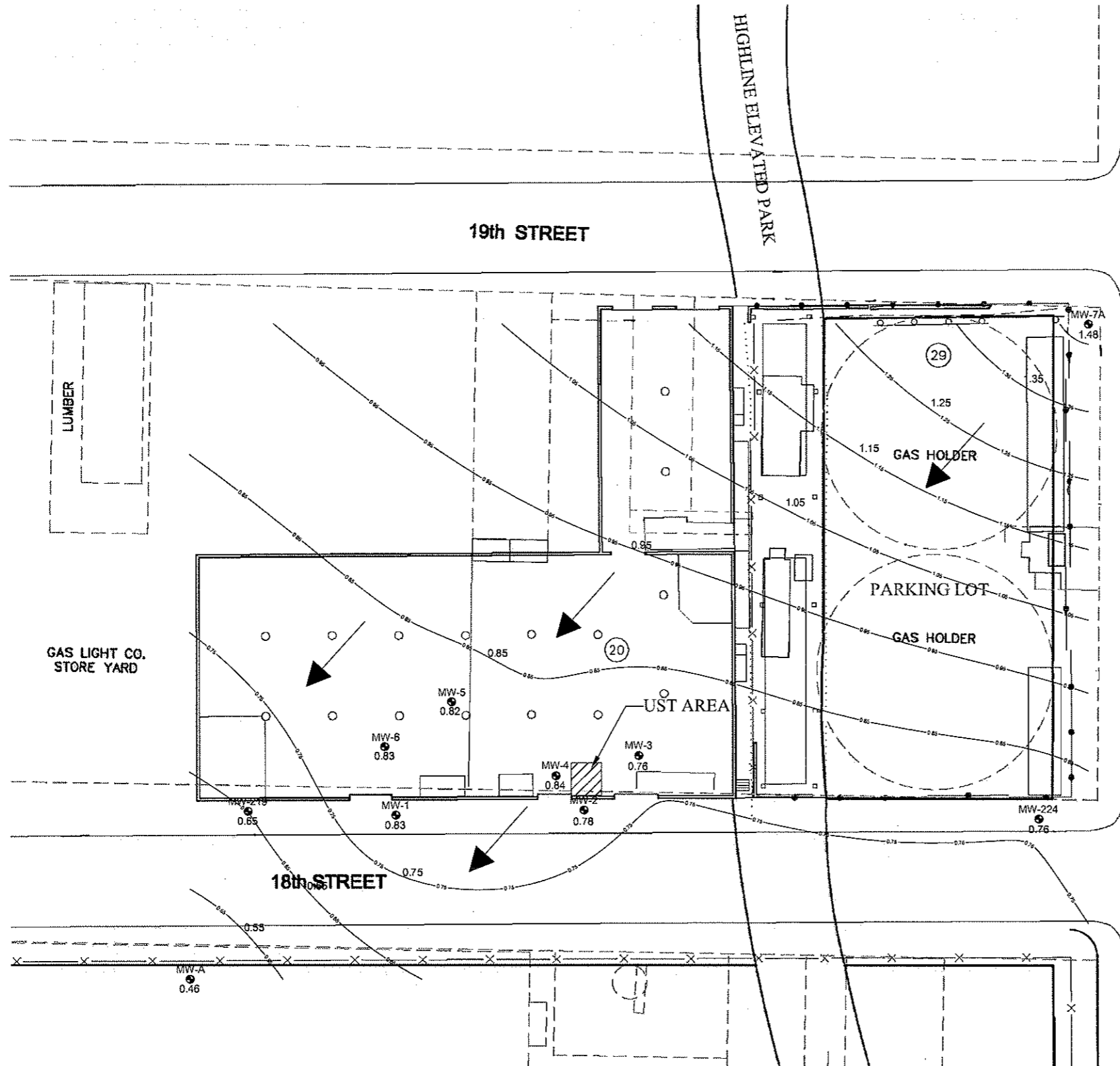

- LEGEND:
- MONITORING WELL
 - GROUNDWATER ELEVATION
 - GENERAL GROUNDWATER FLOW DIRECTION

- NOTES:
- DATE OF FIELD SURVEY: FEBRUARY 2, 2012
 - HORIZONTAL & VERTICAL DATUM: ASSUMED
- LEGEND:
- 1. BASE MAP FROM TRC'S JANUARY 2006 SITE CHARACTERIZATION STUDY.

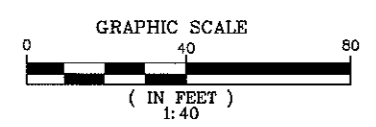

JOB TITLE AND LOCATION:
 515 WEST 18th STREET
 NEW YORK, NY 10011

CORE ENVIRONMENTAL
 46-11 54TH AVENUE MASPETH, N.Y. 11378 T: 718-762-0544 F: 718-762-0545
 2312 WEHRLE DRIVE BUFFALO, N.Y. 14221 T: 716-204-8054 F: 716-204-8557
 www.COREenv.com

DRAWING TITLE: GROUNDWATER CONTOUR PLAN		DRAWING NO: 7
DATE: MARCH 7, 2012	JOB NO: 515-18	
DESIGNED BY: EMM	CHECKED BY: RPT	
DRAWN BY: EMM	PROJ ENG: RPT	
SCALE: 1:40		SHEET 7 OF 11

SB-6		
SAMPLE DEPTH: 10'-10.5'		
CONTAMINANT	SGV (ppb/l)	RESULT (ppb/l)
ANTHRACENE	50,000	250
BENZO(A)ANTHRACENE	1,000	2,330
BENZO(A)PYRENE	1,000	2,660
BENZO(B)FLUORANTHENE	1,000	1,470
BENZO(GH)PERYLENE	100,000	310
BENZO(K)FLUORANTHENE	800	1,810
BUTYL BENZYL PHTHALATE	50,000	389
CHRYSENE	1,000	1,750
DIBENZ(A,H)ANTHRACENE	330	283
FLUORANTHENE	100,000	1,880
FLUORENE	30,000	71.5 J
INDENO (1,2,3-CD) PYRENE	500	459
NAPHTHALENE (SV)	12,000	116 J
PHENANTHRENE	100,000	754
PYRENE	100,000	2,170

SB-5		
SAMPLE DEPTH: 9'-9.5'		
CONTAMINANT	SGV (ppb/l)	RESULT (ppb/l)
2-METHYLNAPHTHALENE	36,400	3,480
ACENAPHTHENE	50,000	439
ANTHRACENE	50,000	233
BENZO(A)ANTHRACENE	1,000	172 J
BENZO(A)PYRENE	1,000	138 J
BENZO(B)FLUORANTHENE	1,000	137 J
BENZO(K)FLUORANTHENE	800	114 J
BIS(2-ETHYLHEXYL)PHTHALATE	50,000	95.2 J
CHRYSENE	1,000	277
FLUORANTHENE	100,000	672
PHENANTHRENE	100,000	1,700
PYRENE	100,000	652

SB-4		
SAMPLE DEPTH: 7'-8'		
CONTAMINANT	SGV (ppb/l)	RESULT (ppb/l)
BENZO(A)ANTHRACENE	1,000	82.4 J
BENZO(A)PYRENE	1,000	113 J
BENZO(B)FLUORANTHENE	1,000	85.4 J
BENZO(GH)PERYLENE	100,000	62.9 J
BENZO(K)FLUORANTHENE	800	95.7 J
BIS(2-ETHYLHEXYL)PHTHALATE	50,000	896
CHRYSENE	1,000	90.7 J
PYRENE	100,000	114 J

SB-7		
SAMPLE DEPTH: 7'-8'		
CONTAMINANT	SGV (ppb/l)	RESULT (ppb/l)
ANTHRACENE	50,000	1,670 J
BENZO(A)ANTHRACENE	1,000	6,360
BENZO(A)PYRENE	1,000	6,360
BENZO(B)FLUORANTHENE	1,000	6,360
BENZO(GH)PERYLENE	1,000	5,260
BENZO(K)FLUORANTHENE	100,000	1,420
BENZO(K)FLUORANTHENE	800	6,150
BIS(2-ETHYLHEXYL)PHTHALATE	50,000	190
CHRYSENE	1,000	5,690
FLUORANTHENE	100,000	9,580
INDENO (1,2,3-CD) PYRENE	500	1,960 J
PHENANTHRENE	100,000	5,240
PYRENE	100,000	6,840

SB-8		
SAMPLE DEPTH: 8'-9'		
CONTAMINANT	SGV (ppb/l)	RESULT (ppb/l)
BIS(2-ETHYLHEXYL)PHTHALATE	50000	150 J

LEGEND:

- SOIL BORING (CORE)
- SOIL BORING/MONITORING WELL (CORE)
- MONITORING WELL (ARCADIS)
- MONITORING WELL (TRC)

NOTES:

1. BASE MAP FROM TRC'S JANUARY 2006 SITE CHARACTERIZATION STUDY.
2. HIGHLIGHTED VALUE INDICATES RESULT EXCEEDS SGV

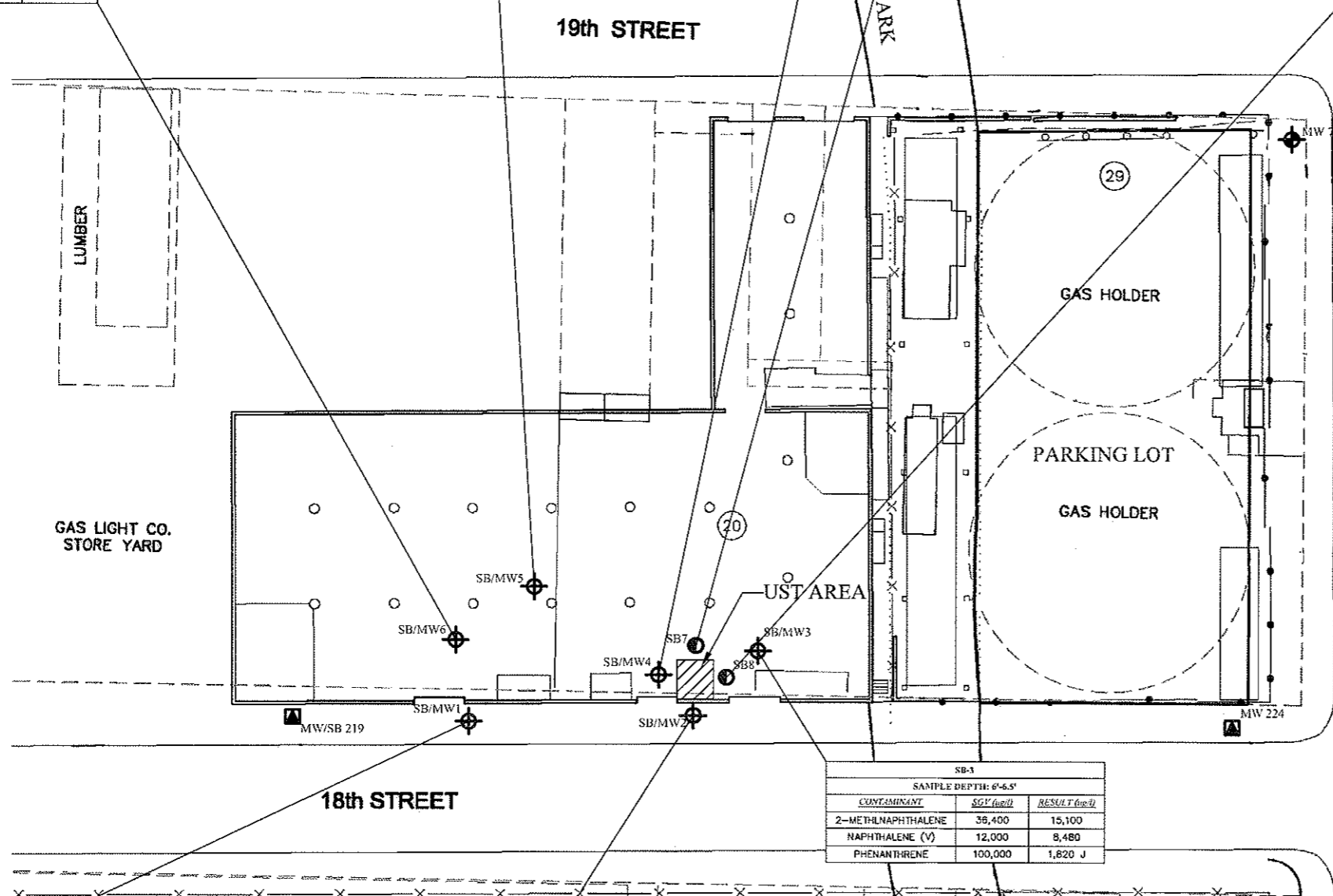

SB-3		
SAMPLE DEPTH: 6'-6.5'		
CONTAMINANT	SGV (ppb/l)	RESULT (ppb/l)
2-METHYLNAPHTHALENE	36,400	15,100
NAPHTHALENE (V)	12,000	8,480
PHENANTHRENE	100,000	1,820 J

SB-1		
SAMPLE DEPTH: 8'-9'		
CONTAMINANT	SGV (ppb/l)	RESULT (ppb/l)
FLUORANTHENE	100,000	146 J
NAPHTHALENE (V)	12,000	215
PYRENE	100,000	139

SB-2		
SAMPLE DEPTH: 8'-9'		
CONTAMINANT	SGV (ppb/l)	RESULT (ppb/l)
ANTHRACENE	50,000	262
FLUORANTHENE	100,000	115 J
FLUORENE	30,000	853
NAPHTHALENE (V)	12,000	393
PHENANTHRENE	100,000	1560
PYRENE	100,000	244

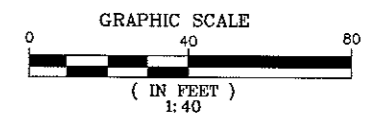

JOB TITLE AND LOCATION:
515 WEST 18th STREET
NEW YORK, NY 10011

CORE ENVIRONMENTAL
 46-11 54TH AVENUE MASPETH, N.Y. 11378
 T: 718-762-0544 F: 718-762-0545
 2312 WGHRIE DRIVE BUFFALO, N.Y. 14221
 T: 716-204-8854 F: 716-204-8557
 www.COREenv.com

SUMMARY OF SVOC'S DETECTED IN SUBSURFACE SOIL PLAN

DATE: MARCH 7, 2012	JOB NO.: 515-18	DRAWING NO.: 9
DRAWN BY: EMM	CHECKED BY: RPT	SCALE: 1:40
DRAWN FOR: EMM	PROJECT: RPT	SHEET: 9 OF 11

MW-6		
SAMPLE DEPTH: 10'-10.5'		
CONTAMINANT	SGV (ug/l)	RESULT (ug/l)
1,2,4-TRIMETHYLBENZENE	5	1.1 J
ACETONE	50	7.3 JB
BENZENE	1	16
ETHYLBENZENE	5	2.2 J
ISOPROPYLBENZENE	5	11
MTBE	10	7
METHYLENE CHLORIDE	5	3.4 JB
NAPHTHALENE (V)	10	1.8 J
n-BUTYLBENZENE	5	2.4 J
n-PROPYLBENZENE	5	10
o-XYLENES	5	1.4 J
p-m XYLENES	5	1.9 J
p-ISOPROPYLTOLUENE	NE	5.4
sec-BUTYLBENZENE	5	3.4 JB
TOLUENE	5	0.93 J
XYLENES, TOTAL		3.2 J

MW-5		
SAMPLE DEPTH: 9'-9.5'		
CONTAMINANT	SGV (ug/l)	RESULT (ug/l)
BENZENE	1	30
ETHYLBENZENE	5	2.5 J
ISOPROPYLBENZENE	5	6.1
MTBE	10	3.6 J
METHYLENE CHLORIDE	5	3.5 JB
NAPHTHALENE (V)	10	1.4 J
n-BUTYLBENZENE	5	1.6 J
n-PROPYLBENZENE	5	6.3
o-XYLENES	5	1.6 J
p-m XYLENES	5	1.6 J
sec-BUTYLBENZENE	5	1.8 J
XYLENES, TOTAL		3.2 J

MW-4		
SAMPLE DEPTH: 7'-5'		
CONTAMINANT	SGV (ug/l)	RESULT (ug/l)
BENZENE	1	83
ETHYLBENZENE	5	3.4 J
ISOPROPYLBENZENE	5	1.6 J
MTBE	10	5.6
METHYLENE CHLORIDE	5	4.3 JB
NAPHTHALENE (V)	10	2 J
o-XYLENES	5	1.9 J
p-m XYLENES	5	2.7 J
XYLENES, TOTAL		4.7 J

MW-7A		
SAMPLE DEPTH: 7'-8'		
CONTAMINANT	SGV (ug/l)	RESULT (ug/l)
ACETONE	50	8.2 JB
BENZENE	1	29
ISOPROPYLBENZENE	5	0.87 J
METHYLENE CHLORIDE	5	4.6 JB

MW-219		
SAMPLE DEPTH: 10'-10.5'		
CONTAMINANT	SGV (ug/l)	RESULT (ug/l)
BENZENE	1	16
ETHYLBENZENE	5	2.2 J
ISOPROPYLBENZENE	5	11
MTBE	10	7
METHYLENE CHLORIDE	5	3.4 JB
NAPHTHALENE (V)	10	1.8 J
n-BUTYLBENZENE	5	2.4 J
n-PROPYLBENZENE	5	10
o-XYLENES	5	1.4 J
p-m XYLENES	5	1.9 J
p-ISOPROPYLTOLUENE	NE	5.4
sec-BUTYLBENZENE	5	3.4 JB
TOLUENE	5	0.93 J
XYLENES, TOTAL		3.2 J

MW-1		
SAMPLE DEPTH: 8'-9'		
CONTAMINANT	SGV (ug/l)	RESULT (ug/l)
BENZENE	1	50
ISOPROPYLBENZENE	5	24 J
METHYLENE CHLORIDE	5	44 JB
n-PROPYLBENZENE	5	22 J

MW-2		
SAMPLE DEPTH: 8'-9'		
CONTAMINANT	SGV (ug/l)	RESULT (ug/l)
1,2,4-TRIMETHYLBENZENE	5	0.94 J
BENZENE	1	390
ETHYLBENZENE	5	1.6 J
ISOPROPYLBENZENE	5	10
MTBE	10	9.6
METHYLENE CHLORIDE	5	4.3 JB
NAPHTHALENE (V)	10	2.6 J
n-PROPYLBENZENE	5	11
o-XYLENES	5	1.2 J
p-m XYLENES	5	4.1 J
sec-BUTYLBENZENE	5	1.8 J
TOLUENE	5	1.5 J
XYLENES, TOTAL		5.3 J

MW-3		
SAMPLE DEPTH: 6'-6.5'		
CONTAMINANT	SGV (ug/l)	RESULT (ug/l)
1,2,4-TRIMETHYLBENZENE	5	8.2
1,3,5-TRIMETHYLBENZENE	5	2.9 J
BENZENE	1	120
ETHYLBENZENE	5	8
ISOPROPYLBENZENE	5	2 J
MTBE	10	6.2
METHYLENE CHLORIDE	5	4 JB
NAPHTHALENE (V)	10	5.2 J
n-BUTYLBENZENE	5	0.91 J
n-PROPYLBENZENE	5	1.9 J
o-XYLENES	5	7.9
p-m XYLENES	5	17
TOLUENE	5	1.3 J
XYLENES, TOTAL		25

MW-224		
SAMPLE DEPTH: 8'-9'		
CONTAMINANT	SGV (ug/l)	RESULT (ug/l)
1,2,4-TRIMETHYLBENZENE	5	1.2 J
BENZENE	1	92
ISOPROPYLBENZENE	5	21
METHYLENE CHLORIDE	5	2.3 JB
NAPHTHALENE (V)	10	4.9 J
n-BUTYLBENZENE	5	6.3
n-PROPYLBENZENE	5	39
o-XYLENES	5	1.2 J
p-m XYLENES	5	3.2 J
sec-BUTYLBENZENE	5	5.2
TOLUENE	5	2.3 J
XYLENES, TOTAL		4.4 J

LEGEND:

- SOIL BORING (CORE)
- SOIL BORING/MONITORING WELL (CORE)
- MONITORING WELL (ARCADIS)
- MONITORING WELL (TRC)

NOTES:

1. BASE MAP FROM TRC'S JANUARY 2006 SITE CHARACTERIZATION STUDY.
2. HIGHLIGHTED VALUE INDICATES RESULT EXCEEDS SGV

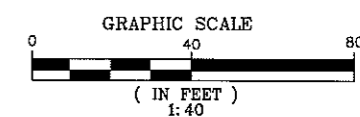
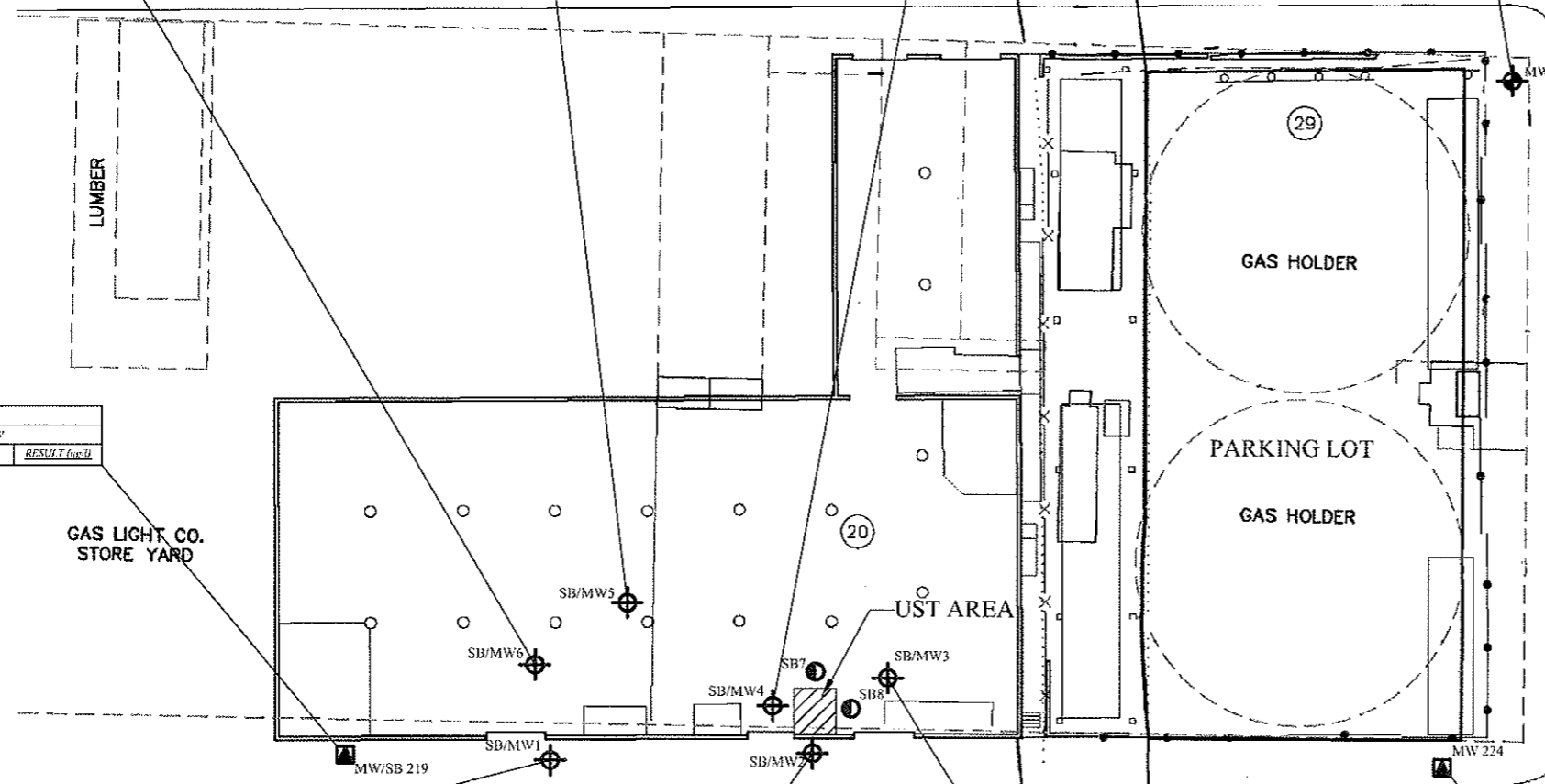

515 WEST 18th STREET
NEW YORK, NY 10011

CORE ENVIRONMENTAL
 46-11 54TH AVENUE MASPETH, N.Y. 11378
 T: 718-762-0544 F: 718-762-0545
 2312 WEHRLE DRIVE BUFFALO, N.Y. 14221
 T: 716-204-8054 F: 716-204-8557
 www.COREenv.com

SUMMARY OF VOC'S DETECTED IN GROUNDWATER PLAN

DATE: MARCH 7, 2012	JOB NO: 515-18	DRAWING NO: 10
DESIGNED BY: EMM	CHECKED BY: RPT	SCALE: 1:40
DRAWN BY: EMM	PROJECT: RPT	SHEET: 10 OF 11

MW-6			MW-5			MW-4			MW-8			MW-7A		
SAMPLE DEPTH: 10'-10.5'			SAMPLE DEPTH: 9'-9.5'			SAMPLE DEPTH: 7'-8"			SAMPLE DEPTH: 8'-9"			SAMPLE DEPTH: 7'-8"		
CONTAMINANT	SGV (mg/l)	RESULT (mg/l)	CONTAMINANT	SGV (mg/l)	RESULT (mg/l)	CONTAMINANT	SGV (mg/l)	RESULT (mg/l)	CONTAMINANT	SGV (mg/l)	RESULT (mg/l)	CONTAMINANT	SGV (mg/l)	RESULT (mg/l)
BIS(2-ETHYLHEXYL)PHTHALATE	5	58.2												

MW-219		
SAMPLE DEPTH: 10'-10.5'		
CONTAMINANT	SGV (mg/l)	RESULT (mg/l)

MW-3		
SAMPLE DEPTH: 6'-6.5'		
CONTAMINANT	SGV (mg/l)	RESULT (mg/l)

MW-224		
SAMPLE DEPTH: 8'-9"		
CONTAMINANT	SGV (mg/l)	RESULT (mg/l)
2-METHYLNAPHTHALENE	4.7	17.8

MW-1		
SAMPLE DEPTH: 8'-9"		
CONTAMINANT	SGV (mg/l)	RESULT (mg/l)
BIS(2-ETHYLHEXYL)PHTHALATE	5	16

MW-2		
SAMPLE DEPTH: 8'-9"		
CONTAMINANT	SGV (mg/l)	RESULT (mg/l)
BIS(2-ETHYLHEXYL)PHTHALATE	5	634

LEGEND:

- SOIL BORING (CORE)
- SOIL BOING/MONITORING WELL (CORE)
- MONITORING WELL (ARCADIS)
- MONITORING WELL (TRC)

NOTES:

1. BASE MAP FROM TRC'S JANUARY 2006 SITE CHARACTERIZATION STUDY.
2. HIGHLIGHTED VALUE INDICATES RESULT EXCEEDS SGV

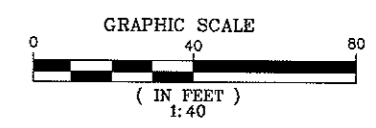

515 WEST 18th STREET
NEW YORK, NY 10011

CORE ENVIRONMENTAL
 46-11 54TH AVENUE MASPETH, N.Y. 11378
 T: 718-762-0544 F: 718-762-0545
 2512 WEHRLE DRIVE BUFFALO, N.Y. 14221
 T: 716-204-8054 F: 716-204-8557
 www.COREenv.com

SUMMARY OF SVOC'S DETECTED IN GROUNDWATER PLAN			
DATE: MARCH 7, 2012	ROW NO.: 515-18	DRAWING NO.: 11	
DESIGNED BY: EMM	CHECKED BY: RPT	SCALE: 1:40	11 OF 11
DRAWN BY: EMM	PROJECT: RPT	SHEET: 11	

APPENDIX A

Historical Spill Site Information



**NEW YORK STATE
DEPARTMENT OF
ENVIRONMENTAL CONSERVATION**

Spill Incidents Database Search Details

Spill Record

MTBE detected at this location, [Click here](#) for more information on MTBE.

Administrative Information

DEC Region: 2

Spill Number: 0311002

Spill Date/Time

Spill Date: 12/24/2003 **Spill Time:** 10:50:00 AM

Call Received Date: 12/26/2003 **Call Received Time:** 10:52:00 AM

Location

Spill Name: CONSTRUCTION SITE

Address: 438 WEST 19TH ST

City: MANHATTAN **County:** NEW_YORK

Spill Description

Material Spilled	Amount Spilled	Resource Affected
Gasoline	UNKNOWN	Soil
MTBE (METHYL-TERT-BUTYL ETHER)	UNKNOWN	Unknown

Cause: Human Error

Source: Commercial/Industrial

Waterbody:

Record Close

Date Spill Closed: 04/19/2006

"Date Spill Closed" means the date the spill case was closed by the case manager in the Department of Environmental Conservation (the Department). The spill case was closed because either; a) the records and data submitted indicate that the necessary cleanup and removal actions have been completed and no further remedial activities are necessary, or b) the case was closed for administrative reasons (e.g., multiple reports of a single spill consolidated into a single spill number). The Department however reserves the right to require additional remedial work in relation to the spill, if in the future it determines that further action is necessary.

If you have questions about this reported incident, please contact the Regional Office where the incident occurred.

Refine Current Search



NEW YORK STATE
DEPARTMENT OF
ENVIRONMENTAL CONSERVATION

Spill Incidents Database Search Details

Spill Record

Administrative Information

DEC Region: 2

Spill Number: 9210231

Spill Date/Time

Spill Date: 12/03/1992 **Spill Time:** 12:00:00 AM

Call Received Date: 12/03/1992 **Call Received Time:** 12:00:00 AM

Location

Spill Name: GETTY

Address: 152 10TH AVE

City: MANHATTAN **County:** NEW_YORK

Spill Description

Material Spilled	Amount Spilled	Resource Affected
UNKNOWN MATERIAL	UNKNOWN	Soil

Cause: Tank Test Failure

Source: Unknown

Waterbody:

Record Close

Date Spill Closed: 03/10/2004

"Date Spill Closed" means the date the spill case was closed by the case manager in the Department of Environmental Conservation (the Department). The spill case was closed because either; a) the records and data submitted indicate that the necessary cleanup and removal actions have been completed and no further remedial activities are necessary, or b) the case was closed for administrative reasons (e.g., multiple reports of a single spill consolidated into a single spill number). The Department however reserves the right to require additional remedial work in relation to the spill, if in the future it determines that further action is necessary.

If you have questions about this reported incident, please contact the Regional Office where the incident occurred.

Refine Current Search



NEW YORK STATE
DEPARTMENT OF
ENVIRONMENTAL CONSERVATION

Spill Incidents Database Search Details

Spill Record

Administrative Information

DEC Region: 2

Spill Number: 9406402

Spill Date/Time

Spill Date: 08/10/1994 **Spill Time:** 05:00:00 PM

Call Received Date: 08/10/1994 **Call Received Time:** 09:23:00 AM

Location

Spill Name: BROADWAY BUILDING MATERIALS

Address: 501-513 W. 19TH STREET

City: MANHATTAN **County:** NEW_YORK

Spill Description

Material Spilled **Amount Spilled** **Resource Affected**

Diesel UNKNOWN Soil

Cause: Equipment Failure
Source: Commercial/Industrial
Waterbody:

Record Close

Date Spill Closed: Not closed

If you have questions about this reported incident, please contact the Regional Office where the incident occurred.

[Refine Current Search](#)



**NEW YORK STATE
DEPARTMENT OF
ENVIRONMENTAL CONSERVATION**

Spill Incidents Database Search Details

Spill Record

Administrative Information

DEC Region: 2

Spill Number: 9514181

Spill Date/Time

Spill Date: 02/07/1996 **Spill Time:** 11:30:00 AM

Call Received Date: 02/07/1996 **Call Received Time:** 12:40:00 PM

Location

Spill Name: MENDON LEASING CORP.

Address: 515 WEST 18TH STREET

City: NYC **County:** NEW_YORK

Spill Description

Material Spilled	Amount Spilled	Resource Affected
-------------------------	-----------------------	--------------------------

Material not identified	N/A	
-------------------------	-----	--

Cause: Tank Test Failure

Source: Institutional, Educational, Gov., Other

Waterbody:

Record Close

Date Spill Closed: 03/18/2009

"Date Spill Closed" means the date the spill case was closed by the case manager in the Department of Environmental Conservation (the Department). The spill case was closed because either; a) the records and data submitted indicate that the necessary cleanup and removal actions have been completed and no further remedial activities are necessary, or b) the case was closed for administrative reasons (e.g., multiple reports of a single spill consolidated into a single spill number). The Department however reserves the right to require additional remedial work in relation to the spill, if in the future it determines that further action is necessary.

If you have questions about this reported incident, please contact the Regional Office where the incident occurred.

[Refine Current Search](#)



**NEW YORK STATE
DEPARTMENT OF
ENVIRONMENTAL CONSERVATION**

Spill Incidents Database Search Details

Spill Record

Administrative Information

DEC Region: 2

Spill Number: 9612012

Spill Date/Time

Spill Date: 01/06/1997 **Spill Time:** 10:15:00 AM

Call Received Date: 01/06/1997 **Call Received Time:** 10:58:00 AM

Location

Spill Name: 515 W 18 ST

Address: 515 WEST 18TH ST

City: MANHATTAN **County:** NEW_YORK

Spill Description

Material Spilled **Amount Spilled** **Resource Affected**

Diesel UNKNOWN Soil

Cause: Unknown

Source: Commercial/Industrial

Waterbody:

Record Close

Date Spill Closed: Not closed

If you have questions about this reported incident, please contact the Regional Office where the incident occurred.

[Refine Current Search](#)



**NEW YORK STATE
DEPARTMENT OF
ENVIRONMENTAL CONSERVATION**

Spill Incidents Database Search Details

Spill Record

Administrative Information

DEC Region: 2

Spill Number: 9907805

Spill Date/Time

Spill Date: 09/28/1999 **Spill Time:** 09:00:00 AM

Call Received Date: 09/28/1999 **Call Received Time:** 11:00:00 AM

Location

Spill Name: OLD GAS STATION

Address: 10TH AV / 20TH ST

City: MANHATTAN **County:** NEW_YORK

Spill Description

Material Spilled **Amount Spilled** **Resource Affected**

Gasoline UNKNOWN Air

Cause: Housekeeping
Source: Gasoline Station
Waterbody:

Record Close

Date Spill Closed: 03/04/2003

"Date Spill Closed" means the date the spill case was closed by the case manager in the Department of Environmental Conservation (the Department). The spill case was closed because either; a) the records and data submitted indicate that the necessary cleanup and removal actions have been completed and no further remedial activities are necessary, or b) the case was closed for administrative reasons (e.g., multiple reports of a single spill consolidated into a single spill number). The Department however reserves the right to require additional remedial work in relation to the spill, if in the future it determines that further action is necessary.

If you have questions about this reported incident, please contact the Regional Office where the incident occurred.

Refine Current Search

MAP FINDINGS

Map ID
 Direction
 Distance
 Distance (ft.)
 Elevation

Site

Database(s)

EDR ID Number
 EPA ID Number

A1 **GETTY 58542**
NNE **152 TENTH AVE**
< 1/8 **NEW YORK CITY, NY 10011**
85 ft.

NY UST **U001839223**
NY LTANKS **N/A**
NY HIST UST
NY HIST LTANKS

Site 1 of 6 in cluster A

Relative:
Equal

UST:
 Facility ID: 2-326267
 Program Type: PBS
 Facility Addr2: 152 10TH AVE
 Locality: NY
 SWIS Code: 3101
 DEC Region: 2
 Registered: 1
 Expiration Date: 11/16/2002
 Site Status: Unregulated (<1101 gallons)
 Site Type: Unkown
 Above Ground Tanks: No
 Under Ground Tanks: No

Actual:
11 ft.

LTANKS:

Site ID: 141401
 Spill Date: 12/03/92
 Facility Addr2: Not reported
 Facility ID: 9210231
 Program Number: 9210231
 SWIS: 3101
 Region of Spill: 2
 Investigator: JBVOUGHT
 Referred To: Not reported
 Reported to Dept: 12/03/92
 CID: 08
 Spill Cause: Tank Test Failure
 Water Affected: Not reported
 Spill Source: Unknown
 Spill Notifier: Other
 Cleanup Ceased: / /
 Cleanup Meets Standard: False
 Last Inspection: / /
 Recommended Penalty: Penalty Not Recommended
 UST Involvement: True
 Spill Class: Known release with minimal potential for fire or hazard. DEC Response. Willing Responsible Party. Corrective action taken.
 Spill Closed Dt: 03/10/04
 Remediation Phase: 0
 Date Entered In Computer: 12/03/92
 Spill Record Last Update: 03/10/04
 Spille Namer: Not reported
 Spiller Company: GETTY
 Spiller Phone: Not reported
 Spiller Extention: Not reported
 Spiller Address: Not reported
 Spiller City,St,Zip: NY
 Spiller County: 999
 Spiller Contact: Not reported
 Spiller Phone: Not reported
 Spiller Extention: Not reported
 DEC Region: 2
 Program Number: 9210231

Map ID
Direction
Distance
Distance (ft.)
Elevation

MAP FINDINGS

GETTY 58542 (Continued)

EDR ID Number
EPA ID Number

Database(s)

U001839223

DER Facility ID: 120725
Site ID: 141401
Operable Unit ID: 976702
Operable Unit: 01
Material ID: 407234
Material Code: 0064A
Material Name: UNKNOWN MATERIAL
Case No.: Not reported
Material FA: Other
Quantity: 0.00
Units: Pounds
Recovered: 0.00
Resource Affected: Soil
Oxygenate: False
Site ID: Not reported
Spill Tank Test: Not reported
Tank Number: Not reported
Tank Size: Not reported
Test Method: Not reported
Leak Rate: Not reported
Gross Fail: Not reported
Modified By: Not reported
Last Modified: Not reported
Test Method: Not reported
DEC Remarks: Start CallerRemark - 9210231 ORIGINAL SPILL ASSIGNED TO O'DOWD. END
CallerRemark - 9210231
Remarks: Start DECRemark - 9210231 Prior to Sept, 2004 data translation this spill Lead
DEC Field was "VOUGHT" 3/14/03 REASSIGNED FROM ROMMEL TO VOUGHT.
3/9/04-Vought-File review by Vought: Letter from DEC(O'Dowd) to
Getty(Ochoterena)-12/10/97. Lettersent requiring installation of three
monitoring wells in response to tank test failure on 12/3/92. Report due to
DEC by close of business 1/30/98. Site notes by DEC O'Dowd-meeting held on
11/12/97. Site planned for construction of new residential building. Tank
Closure Report (Tyree Organization William Conroy)-April 1998. Reason for tank
closure is property divestment. One pump island located adjacent to 10th
Avenue. Removal of twelve (550-gallon) gasoline USTs and one (550-gallon)waste
oil from 3/23-3/25/98. "Multistory commercial and apartment buildings located
across 10th Avenue to the west, church with a school and playground loated
across West 20th Street to the north of the subject property". Six endpoint
samples werecollected including five from the gasoline excavation and one
composite sample from the waste oil excavation. Soil analytials show 9990ppb
toluene(south wall), 10600ppb napthalene(south wall), 10000ppb toulene(west
wall), 15900ppb napthalene(west wall), 156ppb MTBE (Bottom). Waste oil soil
endpoint shows 427ppb benzo(a)anthracene and 411ppb benzo(b)fluoranthene.
Addendum to the Tank Closure Report (Tyree Org)-5/25/98. "The additional work
consisted of further excavation of th west wall and the south wall of the
gasoline tankfield excavation. The additional excavation resulted in
clean(STARS Memo) endpoint soil samples from the two walls." Excavation
indicated the presence of a former basement filled with demolition debris.
Depth to groundwater estimated at 9" below grade. Two additional soil
endpoints were collected for analysis. Soil endpoint analyticals show not TAGM
4046 Soil Cleanup Objective exceedances after second excavation event.
Project Summary Report (Tyree Org)-5/25/98."One groundwater sampling event
prior to the destruction of the wells during removal of underground storage
tanks." Groundwater analyticals show 173ppb MTBE(W-1), 1200ppb MTBE(W-2) and
1890ppb MTBE(W-3). Groundwater flow direction notdetermined. Closure
Request (Tyree Org)-7/8/99. "The property was sold by Tyree's client to the

Map ID
Direction
Distance
Distance (ft.)
Elevation Site

MAP FINDINGS

EDR ID Number
EPA ID Number
Database(s)

GETTY 58542 (Continued)

U001839223

20th Street Association, LLC. The owner has excavated the property for construction purposes". "These three wells were destroyed in March 1998 when the gasoline tanks were removed". A total of 305.11 tons of soil were removed from the tankfield excavation. "The entire lot (approximately 114' x 100') has been excavated to the property lines and to a depth of approximately 15'. Tyree requests closure based on 1) only ethylbenzene in one well at 6.1ppb 2) the levels of MTBE were probably significantly reduced by removal of approximately 9 feet of unsaturated and 6' of saturated soil 3) approximately 8550 tons of soil were removed. Tyree requests no further action. Vought reviewed site with DEC Rommel which resulted in spill closure. END DEC Remark - 9210231

HIST UST:

PBS Number: 2-326267
SPDES Number: Not reported
Emergency Contact: EDWARD WALDRON
Emergency Telephone: (718) 729-6500
Operator: L BARKER
Operator Telephone: (212) 675-5854
Owner Name: GETTY
Owner Address: 125 JERICHO TURNPIKE
Owner City,St,Zip: JERICHO, NY 11753
Owner Telephone: (516) 338-1400
Owner Type: Corporate/Commercial
Owner Subtype: Not reported
Mailing Name: GETY
Mailing Address: 30-23 GREENPOINT AVENUE
Mailing Address 2: Not reported
Mailing City,St,Zip: LONG ISLAND CITY, NY 11101
Mailing Contact: LUIS OCHONTORENA
Mailing Telephone: (516) 694-9696
Owner Mark: First Owner
Facility Status: 2 - Unregulated by PBS (the total capacity is less than 1,101 gallons) and Subpart 360-14.
Facility Addr2: 152 10TH AVE
Tank Id: 001
Tank Location: UNDERGROUND
Install Date: 19980301
Capacity (gals): 550
Product Stored: UNLEADED GASOLINE
Tank Type: Steel/carbon steel
Tank Internal: None
Tank External: None
Pipe Location: Underground
Pipe Type: GALVANIZED STEEL
Pipe Internal: None
Pipe External: None
Second Containment: None
Leak Detection: None
Overfill Prot: None
Dispenser: Suction
Date Tested: 09/01/1993
Next Test Date: Not reported
Missing Data for Tank: No Missing Data
Date Closed: 03/01/1998
Test Method: Unknown
Deleted: False

Map ID
Direction
Distance
Distance (ft.)
Elevation Site

MAP FINDINGS

EDR ID Number
EPA ID Number
Database(s)

GETTY 58542 (Continued)

U001839223

Updated: True
Lat/long: Not reported
Lat/long: Not reported
SWIS ID: 6201
Old PBS Number: Not reported
Facility Type: Not reported
Inspected Date: Not reported
Inspector: Not reported
Inspection Result: Not reported
Federal ID: Not reported
Certification Flag: False
Certification Date: 02/19/1998
Expiration Date: 11/16/2002
Renew Flag: False
Renewal Date: Not reported
Total Capacity: 0
FAMT: True
Facility Screen: Minor Data Missing
Owner Screen: No Missing Data
Tank Screen: 0
Dead Letter: False
CBS Number: Not reported
Town or City: NEW YORK CITY
County Code: 62
Town or City: 01
Region: 2

PBS Number: 2-326267
SPDES Number: Not reported
Emergency Contact: EDWARD WALDRON
Emergency Telephone: (718) 729-6500
Operator: L BARKER
Operator Telephone: (212) 675-5854
Owner Name: GETTY
Owner Address: 125 JERICHO TURNPIKE
Owner City,St,Zip: JERICHO, NY 11753
Owner Telephone: (516) 338-1400
Owner Type: Corporate/Commercial
Owner Subtype: Not reported
Mailing Name: GETY
Mailing Address: 30-23 GREENPOINT AVENUE
Mailing Address 2: Not reported
Mailing City,St,Zip: LONG ISLAND CITY, NY 11101
Mailing Contact: LUIS OCHONTORENA
Mailing Telephone: (516) 694-9696
Owner Mark: First Owner
Facility Status: 2 - Unregulated by PBS (the total capacity is less than 1,101 gallons) and Subpart 360-14.

Facility Addr2: 152 10TH AVE
Tank Id: 002
Tank Location: UNDERGROUND
Install Date: 19980301
Capacity (gals): 550
Product Stored: UNLEADED GASOLINE
Tank Type: Steel/carbon steel
Tank Internal: None
Tank External: None

Map ID
Direction
Distance
Distance (ft.)
Elevation Site

MAP FINDINGS

Database(s)
EDR ID Number
EPA ID Number

GETTY 58542 (Continued)

U001839223

Pipe Location: Underground
Pipe Type: GALVANIZED STEEL
Pipe Internal: None
Pipe External: None
Second Containment: None
Leak Detection: None
Overfill Prot: None
Dispenser: Suction
Date Tested: 09/01/1993
Next Test Date: Not reported
Missing Data for Tank: No Missing Data
Date Closed: 03/01/1998
Test Method: Unknown
Deleted: False
Updated: True
Lat/long: Not reported
Lat/long: Not reported
SWIS ID: 6201
Old PBS Number: Not reported
Inspected Date: Not reported
Inspector: Not reported
Inspection Result: Not reported
Federal ID: Not reported
Certification Flag: False
Certification Date: 02/19/1998
Expiration Date: 11/16/2002
Renew Flag: False
Renewal Date: Not reported
Total Capacity: 0
FAMT: True
Facility Screen: Minor Data Missing
Owner Screen: No Missing Data
Tank Screen: 0
Dead Letter: False
CBS Number: Not reported
Town or City: NEW YORK CITY
County Code: 62
Town or City: 01
Region: 2

PBS Number: 2-326267
SPDES Number: Not reported
Emergency Contact: EDWARD WALDRON
Emergency Telephone: (718) 729-6500
Operator: L BARKER
Operator Telephone: (212) 675-5854
Owner Name: GETTY
Owner Address: 125 JERICHO TURNPIKE
Owner City,St,Zip: JERICHO, NY 11753
Owner Telephone: (516) 338-1400
Owner Type: Corporate/Commercial
Owner Subtype: Not reported
Mailing Name: GETY
Mailing Address: 30-23 GREENPOINT AVENUE
Mailing Address 2: Not reported
Mailing City,St,Zip: LONG ISLAND CITY, NY 11101
Mailing Contact: LUIS OCHONTORENA

Map ID
Direction
Distance
Distance (ft.)
Elevation Site

MAP FINDINGS

Database(s)
EDR ID Number
EPA ID Number

GETTY 58542 (Continued)

U001839223

Mailing Telephone: (516) 694-9696
Owner Mark: First Owner
Facility Status: 2 - Unregulated by PBS (the total capacity is less than 1,101 gallons) and Subpart 360-14.
Facility Addr2: 152 10TH AVE
Tank Id: 003
Tank Location: UNDERGROUND
Install Date: 19980301
Capacity (gals): 550
Product Stored: UNLEADED GASOLINE
Tank Type: Steel/carbon steel
Tank Internal: None
Tank External: None
Pipe Location: Underground
Pipe Type: GALVANIZED STEEL
Pipe Internal: None
Pipe External: None
Second Containment: None
Leak Detection: None
Overfill Prot: None
Dispenser: Suction
Date Tested: 09/01/1993
Next Test Date: Not reported
Missing Data for Tank: No Missing Data
Date Closed: 03/01/1998
Test Method: Unknown
Deleted: False
Updated: True
Lat/long: Not reported
Lat/long: Not reported
SWIS ID: 6201
Old PBS Number: Not reported
Inspected Date: Not reported
Inspector: Not reported
Inspection Result: Not reported
Federal ID: Not reported
Certification Flag: False
Certification Date: 02/19/1998
Expiration Date: 11/16/2002
Renew Flag: False
Renewal Date: Not reported
Total Capacity: 0
FAMT: True
Facility Screen: Minor Data Missing
Owner Screen: No Missing Data
Tank Screen: 0
Dead Letter: False
CBS Number: Not reported
Town or City: NEW YORK CITY
County Code: 62
Town or City: 01
Region: 2

PBS Number: 2-326267
SPDES Number: Not reported
Emergency Contact: EDWARD WALDRON
Emergency Telephone: (718) 729-6500

Map ID
Direction
Distance
Distance (ft.)
Elevation Site

MAP FINDINGS

Database(s)
EDR ID Number
EPA ID Number

GETTY 58542 (Continued)

U001839223

Operator: L BARKER
Operator Telephone: (212) 675-5854
Owner Name: GETTY
Owner Address: 125 JERICHO TURNPIKE
Owner City,St,Zip: JERICHO, NY 11753
Owner Telephone: (516) 338-1400
Owner Type: Corporate/Commercial
Owner Subtype: Not reported
Mailing Name: GETY
Mailing Address: 30-23 GREENPOINT AVENUE
Mailing Address 2: Not reported
Mailing City,St,Zip: LONG ISLAND CITY, NY 11101
Mailing Contact: LUIS OCHONTORENA
Mailing Telephone: (516) 694-9696
Owner Mark: First Owner
Facility Status: 2 - Unregulated by PBS (the total capacity is less than 1,101 gallons) and Subpart 360-14.
Facility Addr2: 152 10TH AVE
Tank Id: 004
Tank Location: UNDERGROUND
Install Date: 19980301
Capacity (gals): 550
Product Stored: UNLEADED GASOLINE
Tank Type: Steel/carbon steel
Tank Internal: None
Tank External: None
Pipe Location: Underground
Pipe Type: GALVANIZED STEEL
Pipe Internal: None
Pipe External: None
Second Containment: None
Leak Detection: None
Overfill Prot: None
Dispenser: Suction
Date Tested: 09/01/1993
Next Test Date: Not reported
Missing Data for Tank: No Missing Data
Date Closed: 03/01/1998
Test Method: Unknown
Deleted: False
Updated: True
Lat/long: Not reported
Lat/long: Not reported
SWIS ID: 6201
Old PBS Number: Not reported
Inspected Date: Not reported
Inspector: Not reported
Inspection Result: Not reported
Federal ID: Not reported
Certification Flag: False
Certification Date: 02/19/1998
Expiration Date: 11/16/2002
Renew Flag: False
Renewal Date: Not reported
Total Capacity: 0
FAMT: True
Facility Screen: Minor Data Missing

Map ID
Direction
Distance
Distance (ft.)
Elevation Site

MAP FINDINGS

Database(s) EDR ID Number
EPA ID Number

GETTY 58542 (Continued)

U001839223

Owner Screen: No Missing Data
Tank Screen: 0
Dead Letter: False
CBS Number: Not reported
Town or City: NEW YORK CITY
County Code: 62
Town or City: 01
Region: 2

PBS Number: 2-326267
SPDES Number: Not reported
Emergency Contact: EDWARD WALDRON
Emergency Telephone: (718) 729-6500
Operator: L BARKER
Operator Telephone: (212) 675-5854
Owner Name: GETTY
Owner Address: 125 JERICHO TURNPIKE
Owner City,St,Zip: JERICHO, NY 11753
Owner Telephone: (516) 338-1400
Owner Type: Corporate/Commercial
Owner Subtype: Not reported
Mailing Name: GETY
Mailing Address: 30-23 GREENPOINT AVENUE
Mailing Address 2: Not reported
Mailing City,St,Zip: LONG ISLAND CITY, NY 11101
Mailing Contact: LUIS OCHONTORENA
Mailing Telephone: (516) 694-9696
Owner Mark: First Owner
Facility Status: 2 - Unregulated by PBS (the total capacity is less than 1,101 gallons) and Subpart 360-14.

Facility Addr2: 152 10TH AVE
Tank Id: 005
Tank Location: UNDERGROUND
Install Date: 19980301
Capacity (gals): 550
Product Stored: UNLEADED GASOLINE
Tank Type: Steel/carbon steel
Tank Internal: None
Tank External: None
Pipe Location: Underground
Pipe Type: GALVANIZED STEEL
Pipe Internal: None
Pipe External: None
Second Containment: None
Leak Detection: None
Overfill Prot: None
Dispenser: Suction
Date Tested: 09/01/1993
Next Test Date: Not reported
Missing Data for Tank: No Missing Data
Date Closed: 02/01/1998
Test Method: Unknown
Deleted: False
Updated: True
Lat/long: Not reported
Lat/long: Not reported
SWIS ID: 6201

Map ID
Direction
Distance
Distance (ft.)
Elevation Site

MAP FINDINGS

Database(s) EDR ID Number
EPA ID Number

GETTY 58542 (Continued)

U001839223

Old PBS Number: Not reported
Inspected Date: Not reported
Inspector: Not reported
Inspection Result: Not reported
Federal ID: Not reported
Certification Flag: False
Certification Date: 02/19/1998
Expiration Date: 11/16/2002
Renew Flag: False
Renewal Date: Not reported
Total Capacity: 0
FAMT: True
Facility Screen: Minor Data Missing
Owner Screen: No Missing Data
Tank Screen: 0
Dead Letter: False
CBS Number: Not reported
Town or City: NEW YORK CITY
County Code: 62
Town or City: 01
Region: 2

PBS Number: 2-326267
SPDES Number: Not reported
Emergency Contact: EDWARD WALDRON
Emergency Telephone: (718) 729-6500
Operator: L BARKER
Operator Telephone: (212) 675-5854
Owner Name: GETTY
Owner Address: 125 JERICHO TURNPIKE
Owner City,St,Zip: JERICHO, NY 11753
Owner Telephone: (516) 338-1400
Owner Type: Corporate/Commercial
Owner Subtype: Not reported
Mailing Name: GETY
Mailing Address: 30-23 GREENPOINT AVENUE
Mailing Address 2: Not reported
Mailing City,St,Zip: LONG ISLAND CITY, NY 11101
Mailing Contact: LUIS OCHONTORENA
Mailing Telephone: (516) 694-9696
Owner Mark: First Owner
Facility Status: 2 - Unregulated by PBS (the total capacity is less than 1,101 gallons) and Subpart 360-14.
Facility Addr2: 152 10TH AVE
Tank Id: 006
Tank Location: UNDERGROUND
Install Date: 19980301
Capacity (gals): 550
Product Stored: UNLEADED GASOLINE
Tank Type: Steel/carbon steel
Tank Internal: None
Tank External: None
Pipe Location: Underground
Pipe Type: GALVANIZED STEEL
Pipe Internal: None
Pipe External: None
Second Containment: None

Map ID
Direction
Distance
Distance (ft.)
Elevation Site

MAP FINDINGS

Database(s)
EDR ID Number
EPA ID Number

GETTY 58542 (Continued)

U001839223

Leak Detection: None
Overfill Prot: None
Dispenser: Suction
Date Tested: 09/01/1993
Next Test Date: Not reported
Missing Data for Tank: No Missing Data
Date Closed: 03/01/1998
Test Method: Unknown
Deleted: False
Updated: True
Lat/long: Not reported
Lat/long: Not reported
SWIS ID: 6201
Old PBS Number: Not reported
Inspected Date: Not reported
Inspector: Not reported
Inspection Result: Not reported
Federal ID: Not reported
Certification Flag: False
Certification Date: 02/19/1998
Expiration Date: 11/16/2002
Renew Flag: False
Renewal Date: Not reported
Total Capacity: 0
FAMT: True
Facility Screen: Minor Data Missing
Owner Screen: No Missing Data
Tank Screen: 0
Dead Letter: False
CBS Number: Not reported
Town or City: NEW YORK CITY
County Code: 62
Town or City: 01
Region: 2

PBS Number: 2-326267
SPDES Number: Not reported
Emergency Contact: EDWARD WALDRON
Emergency Telephone: (718) 729-6500
Operator: L BARKER
Operator Telephone: (212) 675-5854
Owner Name: GETTY
Owner Address: 125 JERICHO TURNPIKE
Owner City,St,Zip: JERICHO, NY 11753
Owner Telephone: (516) 338-1400
Owner Type: Corporate/Commercial
Owner Subtype: Not reported
Mailing Name: GETY
Mailing Address: 30-23 GREENPOINT AVENUE
Mailing Address 2: Not reported
Mailing City,St,Zip: LONG ISLAND CITY, NY 11101
Mailing Contact: LUIS OCHONTORENA
Mailing Telephone: (516) 694-9696
Owner Mark: First Owner
Facility Status: 2 - Unregulated by PBS (the total capacity is less than 1,101 gallons) and Subpart 360-14.
Facility Addr2: 152 10TH AVE

Map ID
Direction
Distance
Distance (ft.)
Elevation

Site

MAP FINDINGS

Database(s)
EDR ID Number
EPA ID Number

GETTY 58542 (Continued)

U001839223

Tank Id: 007
Tank Location: UNDERGROUND
Install Date: 19980301
Capacity (gals): 550
Product Stored: UNLEADED GASOLINE
Tank Type: Steel/carbon steel
Tank Internal: None
Tank External: None
Pipe Location: Underground
Pipe Type: GALVANIZED STEEL
Pipe Internal: None
Pipe External: None
Second Containment: None
Leak Detection: None
Overfill Prot: None
Dispenser: Suction
Date Tested: 09/01/1993
Next Test Date: Not reported
Missing Data for Tank: No Missing Data
Date Closed: 03/01/1998
Test Method: Unknown
Deleted: False
Updated: True
Lat/long: Not reported
Lat/long: Not reported
SWIS ID: 6201
Old PBS Number: Not reported
Inspected Date: Not reported
Inspector: Not reported
Inspection Result: Not reported
Federal ID: Not reported
Certification Flag: False
Certification Date: 02/19/1998
Expiration Date: 11/16/2002
Renew Flag: False
Renewal Date: Not reported
Total Capacity: 0
FAMT: True
Facility Screen: Minor Data Missing
Owner Screen: No Missing Data
Tank Screen: 0
Dead Letter: False
CBS Number: Not reported
Town or City: NEW YORK CITY
County Code: 62
Town or City: 01
Region: 2

PBS Number: 2-326267
SPDES Number: Not reported
Emergency Contact: EDWARD WALDRON
Emergency Telephone: (718) 729-6500
Operator: L BARKER
Operator Telephone: (212) 675-5854
Owner Name: GETTY
Owner Address: 125 JERICO TURNPIKE
Owner City,St,Zip: JERICO, NY 11753

Map ID
Direction
Distance
Distance (ft.)
Elevation Site

MAP FINDINGS

Database(s)
EDR ID Number
EPA ID Number

GETTY 58542 (Continued)

U001839223

Owner Telephone: (516) 338-1400
Owner Type: Corporate/Commercial
Owner Subtype: Not reported
Mailing Name: GETY
Mailing Address: 30-23 GREENPOINT AVENUE
Mailing Address 2: Not reported
Mailing City,St,Zip: LONG ISLAND CITY, NY 11101
Mailing Contact: LUIS OCHONTORENA
Mailing Telephone: (516) 694-9696
Owner Mark: First Owner
Facility Status: 2 - Unregulated by PBS (the total capacity is less than 1,101 gallons) and Subpart 360-14.
Facility Addr2: 152 10TH AVE
Tank Id: 008
Tank Location: UNDERGROUND
Install Date: 19980301
Capacity (gals): 550
Product Stored: UNLEADED GASOLINE
Tank Type: Steel/carbon steel
Tank Internal: None
Tank External: None
Pipe Location: Underground
Pipe Type: GALVANIZED STEEL
Pipe Internal: None
Pipe External: None
Second Containment: None
Leak Detection: None
Overfill Prot: None
Dispenser: Suction
Date Tested: 09/01/1993
Next Test Date: Not reported
Missing Data for Tank: No Missing Data
Date Closed: 03/01/1998
Test Method: Unknown
Deleted: False
Updated: True
Lat/long: Not reported
Lat/long: Not reported
SWIS ID: 6201
Old PBS Number: Not reported
Inspected Date: Not reported
Inspector: Not reported
Inspection Result: Not reported
Federal ID: Not reported
Certification Flag: False
Certification Date: 02/19/1998
Expiration Date: 11/16/2002
Renew Flag: False
Renewal Date: Not reported
Total Capacity: 0
FAMT: True
Facility Screen: Minor Data Missing
Owner Screen: No Missing Data
Tank Screen: 0
Dead Letter: False
CBS Number: Not reported
Town or City: NEW YORK CITY

Map ID
Direction
Distance
Distance (ft.)
Elevation

Site

MAP FINDINGS

Database(s)

EDR ID Number
EPA ID Number

GETTY 58542 (Continued)

U001839223

County Code: 62
Town or City: 01
Region: 2

PBS Number: 2-326267
SPDES Number: Not reported
Emergency Contact: EDWARD WALDRON
Emergency Telephone: (718) 729-6500
Operator: L BARKER
Operator Telephone: (212) 675-5854
Owner Name: GETTY
Owner Address: 125 JERICHO TURNPIKE
Owner City,St,Zip: JERICHO, NY 11753
Owner Telephone: (516) 338-1400
Owner Type: Corporate/Commercial
Owner Subtype: Not reported
Mailing Name: GETY
Mailing Address: 30-23 GREENPOINT AVENUE
Mailing Address 2: Not reported
Mailing City,St,Zip: LONG ISLAND CITY, NY 11101
Mailing Contact: LUIS OCHONTORENA
Mailing Telephone: (516) 694-9696
Owner Mark: First Owner
Facility Status: 2 - Unregulated by PBS (the total capacity is less than 1,101 gallons) and Subpart 360-14.

Facility Addr2: 152 10TH AVE
Tank Id: 009
Tank Location: UNDERGROUND
Install Date: 19980301
Capacity (gals): 550
Product Stored: UNLEADED GASOLINE
Tank Type: Steel/carbon steel
Tank Internal: None
Tank External: None
Pipe Location: Underground
Pipe Type: GALVANIZED STEEL
Pipe Internal: None
Pipe External: None
Second Containment: None
Leak Detection: None
Overfill Prot: None
Dispenser: Suction
Date Tested: 09/01/1993
Next Test Date: Not reported
Missing Data for Tank: No Missing Data
Date Closed: 03/01/1998
Test Method: Unknown
Deleted: False
Updated: True
Lat/long: Not reported
Lat/long: Not reported
SWIS ID: 6201
Old PBS Number: Not reported
Inspected Date: Not reported
Inspector: Not reported
Inspection Result: Not reported
Federal ID: Not reported

Map ID
Direction
Distance
Distance (ft.)
Elevation Site

MAP FINDINGS

Database(s) EDR ID Number
EPA ID Number

GETTY 58542 (Continued)

U001839223

Certification Flag: False
Certification Date: 02/19/1998
Expiration Date: 11/16/2002
Renew Flag: False
Renewal Date: Not reported
Total Capacity: 0
FAMT: True
Facility Screen: Minor Data Missing
Owner Screen: No Missing Data
Tank Screen: 0
Dead Letter: False
CBS Number: Not reported
Town or City: NEW YORK CITY
County Code: 62
Town or City: 01
Region: 2

PBS Number: 2-326267
SPDES Number: Not reported
Emergency Contact: EDWARD WALDRON
Emergency Telephone: (718) 729-6500
Operator: L BARKER
Operator Telephone: (212) 675-5854
Owner Name: GETTY
Owner Address: 125 JERICHO TURNPIKE
Owner City,St,Zip: JERICHO, NY 11753
Owner Telephone: (516) 338-1400
Owner Type: Corporate/Commercial
Owner Subtype: Not reported
Mailing Name: GETY
Mailing Address: 30-23 GREENPOINT AVENUE
Mailing Address 2: Not reported
Mailing City,St,Zip: LONG ISLAND CITY, NY 11101
Mailing Contact: LUIS OCHONTORENA
Mailing Telephone: (516) 694-9696
Owner Mark: First Owner
Facility Status: 2 - Unregulated by PBS (the total capacity is less than 1,101 gallons) and Subpart 360-14.

Facility Addr2: 152 10TH AVE
Tank Id: 010
Tank Location: UNDERGROUND
Install Date: 19980301
Capacity (gals): 550
Product Stored: UNLEADED GASOLINE
Tank Type: Steel/carbon steel
Tank Internal: None
Tank External: None
Pipe Location: Underground
Pipe Type: GALVANIZED STEEL
Pipe Internal: None
Pipe External: None
Second Containment: None
Leak Detection: None
Overfill Prot: None
Dispenser: Suction
Date Tested: 09/01/1993
Next Test Date: Not reported

Map ID
Direction
Distance
Distance (ft.)
Elevation Site

MAP FINDINGS

Database(s)
EDR ID Number
EPA ID Number

GETTY 58542 (Continued)

U001839223

Missing Data for Tank: No Missing Data
Date Closed: 03/01/1998
Test Method: Unknown
Deleted: False
Updated: True
Lat/long: Not reported
Lat/long: Not reported
SWIS ID: 6201
Old PBS Number: Not reported
Inspected Date: Not reported
Inspector: Not reported
Inspection Result: Not reported
Federal ID: Not reported
Certification Flag: False
Certification Date: 02/19/1998
Expiration Date: 11/16/2002
Renew Flag: False
Renewal Date: Not reported
Total Capacity: 0
FAMT: True
Facility Screen: Minor Data Missing
Owner Screen: No Missing Data
Tank Screen: 0
Dead Letter: False
CBS Number: Not reported
Town or City: NEW YORK CITY
County Code: 62
Town or City: 01
Region: 2

PBS Number: 2-326267
SPDES Number: Not reported
Emergency Contact: EDWARD WALDRON
Emergency Telephone: (718) 729-6500
Operator: L BARKER
Operator Telephone: (212) 675-5854
Owner Name: GETTY
Owner Address: 125 JERICO TURNPIKE
Owner City,St,Zip: JERICO, NY 11753
Owner Telephone: (516) 338-1400
Owner Type: Corporate/Commercial
Owner Subtype: Not reported
Mailing Name: GETY
Mailing Address: 30-23 GREENPOINT AVENUE
Mailing Address 2: Not reported
Mailing City,St,Zip: LONG ISLAND CITY, NY 11101
Mailing Contact: LUIS OCHONTORENA
Mailing Telephone: (516) 694-9696
Owner Mark: First Owner
Facility Status: 2 - Unregulated by PBS (the total capacity is less than 1,101 gallons) and Subpart 360-14.
Facility Addr2: 152 10TH AVE
Tank Id: 011
Tank Location: UNDERGROUND
Install Date: 19980301
Capacity (gals): 550
Product Stored: UNLEADED GASOLINE

Map ID
Direction
Distance
Distance (ft.)
Elevation Site

MAP FINDINGS

EDR ID Number
EPA ID Number
Database(s)

GETTY 58542 (Continued)

U001839223

Tank Type: Steel/carbon steel
Tank Internal: None
Tank External: None
Pipe Location: Underground
Pipe Type: GALVANIZED STEEL
Pipe Internal: None
Pipe External: None
Second Containment: None
Leak Detection: None
Overfill Prot: None
Dispenser: Suction
Date Tested: 09/01/1993
Next Test Date: Not reported
Missing Data for Tank: No Missing Data
Date Closed: 03/01/1998
Test Method: Unknown
Deleted: False
Updated: True
Lat/long: Not reported
Lat/long: Not reported
SWIS ID: 6201
Old PBS Number: Not reported
Inspected Date: Not reported
Inspector: Not reported
Inspection Result: Not reported
Federal ID: Not reported
Certification Flag: False
Certification Date: 02/19/1998
Expiration Date: 11/16/2002
Renew Flag: False
Renewal Date: Not reported
Total Capacity: 0
FAMT: True
Facility Screen: Minor Data Missing
Owner Screen: No Missing Data
Tank Screen: 0
Dead Letter: False
CBS Number: Not reported
Town or City: NEW YORK CITY
County Code: 62
Town or City: 01
Region: 2

PBS Number: 2-326267
SPDES Number: Not reported
Emergency Contact: EDWARD WALDRON
Emergency Telephone: (718) 729-6500
Operator: L BARKER
Operator Telephone: (212) 675-5854
Owner Name: GETTY
Owner Address: 125 JERICO TURNPIKE
Owner City,St,Zip: JERICO, NY 11753
Owner Telephone: (516) 338-1400
Owner Type: Corporate/Commercial
Owner Subtype: Not reported
Mailing Name: GETY
Mailing Address: 30-23 GREENPOINT AVENUE

Map ID
Direction
Distance
Distance (ft.)
Elevation Site

MAP FINDINGS

Database(s) EDR ID Number
EPA ID Number

GETTY 58542 (Continued)

U001839223

Mailing Address 2: Not reported
Mailing City,St,Zip: LONG ISLAND CITY, NY 11101
Mailing Contact: LUIS OCHONTORENA
Mailing Telephone: (516) 694-9696
Owner Mark: First Owner
Facility Status: 2 - Unregulated by PBS (the total capacity is less than 1,101 gallons) and Subpart 360-14.
Facility Addr2: 152 10TH AVE
Tank Id: 012
Tank Location: UNDERGROUND
Install Date: 19980301
Capacity (gals): 550
Product Stored: UNLEADED GASOLINE
Tank Type: Steel/carbon steel
Tank Internal: None
Tank External: None
Pipe Location: Underground
Pipe Type: GALVANIZED STEEL
Pipe Internal: None
Pipe External: None
Second Containment: None
Leak Detection: None
Overfill Prot: None
Dispenser: Suction
Date Tested: 09/01/1993
Next Test Date: Not reported
Missing Data for Tank: No Missing Data
Date Closed: 03/01/1998
Test Method: Unknown
Deleted: False
Updated: True
Lat/long: Not reported
Lat/long: Not reported
SWIS ID: 6201
Old PBS Number: Not reported
Inspected Date: Not reported
Inspector: Not reported
Inspection Result: Not reported
Federal ID: Not reported
Certification Flag: False
Certification Date: 02/19/1998
Expiration Date: 11/16/2002
Renew Flag: False
Renewal Date: Not reported
Total Capacity: 0
FAMT: True
Facility Screen: Minor Data Missing
Owner Screen: No Missing Data
Tank Screen: 0
Dead Letter: False
CBS Number: Not reported
Town or City: NEW YORK CITY
County Code: 62
Town or City: 01
Region: 2

Map ID
Direction
Distance
Distance (ft.)
Elevation

MAP FINDINGS

GETTY 58542 (Continued)

Database(s)
EDR ID Number
EPA ID Number

U001839223

HIST LTANKS:

Region of Spill: 2
Spill Number: 9210231
Investigator: ROMMEL
Caller Name: Not reported
Caller Agency: Not reported
Caller Phone: Not reported
Caller Extension: Not reported
Notifier Name: Not reported
Notifier Agency: Not reported
Notifier Phone: Not reported
Notifier Extension: Not reported
Spill Date: 12/03/1992
Spill Time: 00:00
Reported to Department Date: 12/03/92
Reported to Department Time: Not reported
SWIS: 62
Spiller Contact: Not reported
Spiller Phone: Not reported
Spiller Extension: Not reported
Spiller Name: Not reported
Spiller Address: Not reported
Spiller City, St, Zip: Not reported
Facility Contact: Not reported
Facility Phone: Not reported
Facility Extension: Not reported
Spill Cause: Tank Test Failure
Resource Affectd: On Land
Water Affected: Not reported
Spill Source: Unknown
Spill Notifier: Other
PBS Number: Not reported
Cleanup Ceased: / /
Cleanup Meets Standard: False
Last Inspection: / /
Recommended Penalty: Penalty Not Recommended
Spiller Cleanup Date: / /
Enforcement Date: / /
Investigation Complete: / /
UST Involvement: False
Spill Class: Possible release with minimal potential for fire or hazard or Known release with no damage. DEC Response. Willing Responsible Party. Corrective action taken.
Spill Closed Dt: / /
Date Region Sent Summary to Central Office: / /
Corrective Action Plan Submitted: / /
Date Spill Entered In Computer Data File: 12/03/92
Time Spill Entered In Computer Data File: Not reported
Spill Record Last Update: 01/03/00
Is Updated: False
PBS Number: Not reported
Tank Number: Not reported
Tank Size: Not reported
Test Method: Not reported
Leak Rate Failed Tank: Not reported
Gross Leak Rate: Not reported
Material Class Type: Raw Sewage
Quantity Spilled: 0

Map ID
 Direction
 Distance
 Distance (ft.)
 Elevation Site

MAP FINDINGS

Database(s) EDR ID Number
 EPA ID Number

GETTY 58542 (Continued)

U001839223

Unkonwn Quantity Spilled: False
 Units: Pounds
 Quantity Recovered: 0
 Unkonwn Quantity Recovered: False
 Material: UNKNOWN MATERIAL
 Class Type: UNKNOWN MATERIAL
 Times Material Entry In File: 9140
 CAS Number: Not reported
 Last Date: 19941109
 DEC Remarks: Not reported
 Spill Cause: ORIGINAL SPILL ASSIGNED TO O DOWD.

A2
 NNE
 < 1/8
 85 ft.

GETTY PETROLEUM CORP 58542
152 10TH AVE
NEW YORK, NY 10011

RCRA-SQG 1001224068
FINDS NYR000052845
NY MANIFEST
CT MANIFEST

Site 2 of 6 in cluster A

Relative:
 Equal

RCRAInfo:
 Owner: GETTY PETROLEUM CORP
 (516) 286-2600
 EPA ID: NYR000052845

Actual:
 11 ft.

Contact: Not reported
 Classification: Small Quantity Generator
 TSDF Activities: Not reported
 Violation Status: No violations found

FINDS:

Other Pertinent Environmental Activity Identified at Site

RCRAInfo is a national information system that supports the Resource Conservation and Recovery Act (RCRA) program through the tracking of events and activities related to facilities that generate, transport, and treat, store, or dispose of hazardous waste. RCRAInfo allows RCRA program staff to track the notification, permit, compliance, and corrective action activities required under RCRA.

NY MANIFEST:

Document ID: CTF0510868
 Manifest Status: Not reported
 Trans1 State ID: CTD021816889
 Trans2 State ID: Not reported
 Generator Ship Date: 04/15/1998
 Trans1 Recv Date: 04/15/1998
 Trans2 Recv Date: Not reported
 TSD Site Recv Date: 04/20/1998
 Part A Recv Date: Not reported
 Part B Recv Date: Not reported
 Generator EPA ID: NYR000052845
 Trans1 EPA ID: CTD021816889
 Trans2 EPA ID: Not reported
 TSDF ID: CTHW231
 Waste Code: D001 - NON-LISTED IGNITABLE WASTES

Map ID
 Direction
 Distance
 Distance (ft.)
 Elevation

MAP FINDINGS

DANNY'S PARKING LOT (Continued)

EDR ID Number
 EPA ID Number

Database(s)

S102560422

Test Method: Not reported
 Leak Rate Failed Tank: Not reported
 Gross Leak Rate: Not reported
 Material Class Type: Petroleum
 Quantity Spilled: 0
 Unkonwn Quantity Spilled: True
 Units: Gallons
 Quantity Recovered: 0
 Unkonwn Quantity Recovered: True
 Material: GASOLINE
 Class Type: GASOLINE
 Times Material Entry In File: 21329
 CAS Number: Not reported
 Last Date: 19940929

DEC Remarks: 04/18/97 mmm: DEC DID INSPECTION ON 4/11/97 AND OBSERVED GROSSLY CONTAMINATED SOILS BEING STOCKPILED FOR REMOVAL (150 TONS OUT). WASTE OIL TANK HAD LEAK AND ALSO CONTAMINATED PROPERTY. HARDPAN CLAY WAS ENCOUNTERED IN BOTTOM OF EXCAVATION AND MAY BE POSSIBLE BARRIER AGAINST ADDITIONAL VERTICAL MIGRATION. NEED TO ASSESS GROUNDWATER CONDITONS.
 Remark: PROPERTY WAS A GAS STATION PRIOR TO 1978 - TODAY 3 STEEL TANKS HOLDING 4000 GAL EACH HAVE BEEN EXCAVATED FROM PROPERTY - POSS ANOTHER TANK WILL BE EXCAVATED ALSO-TANKS WERE ENCASED IN CONCRETE TESTING FOR SOIL CONTAMINATION WAS POSITIVE-SOIL STOCK PILED

5
 WSW
 < 1/8
 170 ft.

**CON EDISON - WEST 18TH ST. GAS WORKS MGP
 WEST 16TH - WEST 20TH STS.
 NEW YORK, NY 10011**

**Manufactured Gas Plants 1008407994
 N/A**

Relative:
 Lower

Actual:
 10 ft.
 A6
 NNE
 < 1/8
 210 ft.

**OLD GAS STATION
 10TH AV / 20TH ST
 MANHATTAN, NY**

**NY Spills S104195688
 NY Hist Spills N/A**

Site 5 of 6 in cluster A

Relative:
 Equal

NY Spills:
 Site ID: 170063
 Facility Addr2: Not reported
 Facility ID: 9907805
 Spill Number: 9907805
 Facility Type: ER
 SWIS: 3101
 Region of Spill: 2
 Investigator: TOMASELLO
 Referred To: Not reported
 Spill Date: 09/28/99
 Reported to Dept: 09/28/99
 CID: 312
 Spill Cause: Housekeeping
 Water Affected: Not reported
 Spill Source: Gasoline Station
 Spill Notifier: Affected Persons
 Cleanup Ceased: / /
 Cleanup Meets Std: False

Actual:
 11 ft.

Map ID
Direction
Distance
Distance (ft.)
Elevation Site

MAP FINDINGS

Database(s)
EDR ID Number
EPA ID Number

OLD GAS STATION (Continued)

S104195688

Last Inspection: / /
Recommended Penalty: Penalty Not Recommended
UST Trust: True
Spill Class: Known release with minimal potential for fire or hazard. DEC Response. Willing Responsible Party. Corrective action taken.
Spill Closed Dt: 03/04/03
Remediation Phase: 0
Date Entered In Computer: 09/28/99
Spill Record Last Update: 03/04/03
Spiller Name: Not reported
Spiller Company: Not reported
Spiller Address: Not reported
Spiller City,St,Zip: ***Update***, ZZ
Spiller Company: 001
Spiller Phone: Not reported
Contact Name: Not reported
Contact Phone: Not reported
DEC Region: 2
Program Number: 9907805
DER Facility ID: 143100
Site ID: 170063
Operable Unit ID: 1082077
Operable Unit: 01
Material ID: 300488
Material Code: 0009
Material Name: Gasoline
Case No.: Not reported
Material FA: Petroleum
Quantity: 0.00
Units: Gallons
Recovered: 0.00
Resource Affected: Air
Oxygenate: False
DEC Remarks: Start CallerRemark - 9907805 DIGGING UP THE OLD TANKS AT THE OLD GAS STATION - SEVERE ODORS PRESENT - COMP HAS CALLED NYC DEP ALREADY CASE #75955 END
CallerRemark - 9907805
Remarks: Not reported

NY Hist Spills:
Region of Spill: 2
Spill Number: 9907805
Investigator: TOMASELLO
Caller Name: Not reported
Caller Agency: Not reported
Caller Phone: Not reported
Notifier Name: Not reported
Notifier Agency: Not reported
Notifier Phone: Not reported
Spill Date/Time: 09/28/1999 09:00
Reported to Dept Date/Time: 09/28/99 11:00
SWIS: 62
Spiller Name: Not reported
Spiller Contact: Not reported
Spiller Phone: Not reported
Spiller Address: Not reported
Spiller City,St,Zip: Not reported
Spill Cause: Housekeeping

Map ID
 Direction
 Distance
 Distance (ft.)
 Elevation Site

MAP FINDINGS

Database(s) EDR ID Number
 EPA ID Number

OLD GAS STATION (Continued)

S104195688

Reported to Dept: Air
 Water Affected: Not reported
 Spill Source: 05
 Spill Notifier: Affected Persons
 PBS Number: Not reported
 Cleanup Ceased: / /
 Cleanup Meets Std: False
 Last Inspection: / /
 Recommended Penalty: Penalty Not Recommended
 Spiller Cleanup Dt: / /
 Enforcement Date: / /
 Invstgn Complete: / /
 UST Involvement: False
 Spill Class: Known release with minimal potential for fire or hazard. DEC Response. Willing Responsible Party. Corrective action taken.
 Spill Closed Dt: / /
 Corrective Action Plan Submitted: / /
 Date Region Sent Summary to Central Office: / /
 Date Spill Entered In Computer Data File: 09/28/99
 Date Spill Entered In Computer Data File: Not reported
 Update Date: 09/29/99
 Is Updated: False
 PBS Number: Not reported
 Tank Number: Not reported
 Tank Size: Not reported
 Test Method: Not reported
 Leak Rate Failed Tank: Not reported
 Gross Leak Rate: Not reported
 Material Class Type: Petroleum
 Quantity Spilled: 0
 Unkonwn Quantity Spilled: True
 Units: Gallons
 Quantity Recovered: 0
 Unkonwn Quantity Recovered: False
 Material: GASOLINE
 Class Type: GASOLINE
 Times Material Entry In File: 21329
 CAS Number: Not reported
 Last Date: 19940929
 DEC Remarks: Not reported
 Remark: DIGGING UP THE OLD TANKS AT THE OLD GAS STATION - SEVERE ODORS PRESENT - COMP HAS CALLED NYC DEP ALREADY CASE 75955

A7 W 20 ST AND 10TH AVE
 NNE WEST 20TH ST / 10TH AVE
 < 1/8 MANHATTAN, NY
 210 ft.

NY Spills S104652993
 NY Hist Spills N/A

Site 6 of 6 in cluster A

Relative: NY Spills:
 Equal Site ID: 264326
 Actual: Facility Addr2: Not reported
 11 ft. Facility ID: 0030004
 Spill Number: 0030004
 Facility Type: ER
 SWIS: 3101
 Region of Spill: 2
 Investigator: SXLASDIN

MAP FINDINGS

Map ID
 Direction
 Distance
 Distance (ft.)
 Elevation

Site

Database(s)

EDR ID Number
 EPA ID Number

B8 **501-513 W. 19TH STREET**
WNW **513 W. 19TH STREET**
 < 1/8 **MANHATTAN, NY**
 222 ft.

NY LTANKS **S101340991**
NY HIST LTANKS **N/A**

Site 1 of 5 in cluster B

Relative:
Lower

LTANKS:

Actual:
10 ft.

Site ID: 167544
 Spill Date: 08/10/94
 Facility Addr2: Not reported
 Facility ID: 9406402
 Program Number: 9406402
 SWIS: 3101
 Region of Spill: 2
 Investigator: Needs Reassignment
 Referred To: Not reported
 Reported to Dept: 08/10/94
 CID: 08
 Spill Cause: Tank Failure
 Water Affected: Not reported
 Spill Source: Commercial/Industrial
 Spill Notifier: Other
 Cleanup Ceased: / /
 Cleanup Meets Standard: False
 Last Inspection: / /
 Recommended Penalty: Penalty Not Recommended
 UST Involvement: True
 Spill Class: Known release with minimal potential for fire or hazard. DEC Response. Unknown Responsible Party. Corrective action taken. (ISR)
 Spill Closed Dt: / /
 Remediation Phase: 1
 Date Entered In Computer: 10/20/94
 Spill Record Last Update: 12/20/05
 Spille Namer: Not reported
 Spiller Company: BROWAY BLDG MATERIALS
 Spiller Phone: Not reported
 Spiller Extention: Not reported
 Spiller Address: 501-513 W. 19TH STREET
 Spiller City,St,Zip: NEW YORK, NEW YORK, ZZ
 Spiller County: 001
 Spiller Contact: Not reported
 Spiller Phone: Not reported
 Spiller Extention: Not reported
 DEC Region: 2
 Program Number: 9406402
 DER Facility ID: 141173
 Site ID: 167544
 Operable Unit ID: 1003785
 Operable Unit: 01
 Material ID: 379446
 Material Code: 0008
 Material Name: Diesel
 Case No.: Not reported
 Material FA: Petroleum
 Quantity: -1.00
 Units: Pounds
 Recovered: 0.00
 Resource Affected: Soil
 Oxygenate: False

Map ID
Direction
Distance
Distance (ft.)
Elevation Site

MAP FINDINGS

Database(s) EDR ID Number
EPA ID Number

501-513 W. 19TH STREET (Continued)

S101340991

Site ID: Not reported
Spill Tank Test: Not reported
Tank Number: Not reported
Tank Size: Not reported
Test Method: Not reported
Leak Rate: Not reported
Gross Fail: Not reported
Modified By: Not reported
Last Modified: Not reported
Test Method: Not reported
DEC Remarks: Start CallerRemark - 9406402 STUCK PROBE IN GROUND FOUND CONTAMINATED SOIL AT 9 FEET. WILL PULL TANKS OUT -ONCE THEY CAN SEE ALL CONTAMINATED SOIL THEY CAN REMOVE IT STUCK PILE. END CallerRemark - 9406402
Remarks: Start DECRemark - 9406402 Prior to Sept, 2004 data translation this spill Lead DEC Field was "ROMMEL" 4/12/04-Vought-Spill transferred from Sullivan to Rommel as per Rommel. letter to be sent END DECRemark - 9406402

HIST LTANKS:

Region of Spill: 2
Spill Number: 9406402
Investigator: SULLIVAN
Caller Name: Not reported
Caller Agency: Not reported
Caller Phone: Not reported
Caller Extension: Not reported
Notifier Name: Not reported
Notifier Agency: Not reported
Notifier Phone: Not reported
Notifier Extension: Not reported
Spill Date: 08/10/1994
Spill Time: 17:00
Reported to Department Date: 08/10/94
Reported to Department Time: 09:23
SWIS: 62
Spiller Contact: Not reported
Spiller Phone: Not reported
Spiller Extension: Not reported
Spiller Name: BROWAY BLDG MATERIALS
Spiller Address: 501-513 W. 19TH STREET
Spiller City,St,Zip: NEW YORK, NEW YORK
Facility Contact: Not reported
Facility Phone: Not reported
Facility Extension: Not reported
Spill Cause: Tank Failure
Resource Affectd: On Land
Water Affected: Not reported
Spill Source: Other Commercial/Industrial
Spill Notifier: Other
PBS Number: Not reported
Cleanup Ceased: / /
Cleanup Meets Standard: False
Last Inspection: / /
Recommended Penalty: Penalty Not Recommended
Spiller Cleanup Date: / /
Enforcement Date: / /
Investigation Complete: / /
UST Involvement: True

Map ID
 Direction
 Distance
 Distance (ft.)
 Elevation Site

MAP FINDINGS

Database(s) EDR ID Number
 EPA ID Number

501-513 W. 19TH STREET (Continued)

S101340991

Spill Class: Not reported
 Spill Closed Dt: / /
 Date Region Sent Summary to Central Office: / /
 Corrective Action Plan Submitted: / /
 Date Spill Entered In Computer Data File: 10/20/94
 Time Spill Entered In Computer Data File: Not reported
 Spill Record Last Update: 08/16/95
 Is Updated: False
 PBS Number: Not reported
 Tank Number: Not reported
 Tank Size: Not reported
 Test Method: Not reported
 Leak Rate Failed Tank: Not reported
 Gross Leak Rate: Not reported
 Material Class Type: Petroleum
 Quantity Spilled: -1
 Unkonwn Quantity Spilled: False
 Units: Not reported
 Quantity Recovered: 0
 Unkonwn Quantity Recovered: False
 Material: DIESEL
 Class Type: DIESEL
 Times Material Entry In File: 10625
 CAS Number: Not reported
 Last Date: 19940728
 DEC Remarks: Not reported
 Spill Cause: STUCK PROBE IN GROUND FOUND CONTAMINATED SOIL AT 9 FEET. WILL PULL TANKS OUT
 -ONCE THEY CAN SEE ALL CONTAMINATED SOIL THEY CAN REMOVE IT STUCK PILE.

C9 448 E. 19TH ST
 SE 448 E. 19TH ST
 < 1/8 MANHATTAN, NY
 248 ft.

NY Spills S104495803
 NY Hist Spills N/A

Site 1 of 5 in cluster C

Relative:
 Higher

Actual:
 13 ft.

NY Spills:
 Site ID: 240641
 Facility Addr2: Not reported
 Facility ID: 9410491
 Spill Number: 9410491
 Facility Type: ER
 SWIS: 4101
 Region of Spill: 2
 Investigator: KSTANG
 Referred To: Not reported
 Spill Date: 11/07/94
 Reported to Dept: 11/07/94
 CID: 08
 Spill Cause: Other
 Water Affected: Not reported
 Spill Source: Private Dwelling
 Spill Notifier: Other
 Cleanup Ceased: 11/07/94
 Cleanup Meets Std: True
 Last Inspection: / /
 Recommended Penalty: Penalty Not Recommended
 UST Trust: False
 Spill Class: Known release with minimal potential for fire or hazard. DEC Response. Willing

Map ID
 Direction
 Distance
 Distance (ft.)
 Elevation Site

MAP FINDINGS

Database(s) EDR ID Number
 EPA ID Number

BETW. 9TH/10TH AVE. (Continued)

S106383447

Operable Unit: 01
 Material ID: 555244
 Material Code: 0008
 Material Name: Diesel
 Case No.: Not reported
 Material FA: Petroleum
 Quantity: 0.00
 Units: Pounds
 Recovered: 0.00
 Resource Affected: Air
 Oxygenate: False

DEC Remarks: Start CallerRemark - 0313332 Smell of diesel fuel possible spill. The resource is in the air right now unsure if there is actually a spill. All other info is unknown. END CallerRemark - 0313332

Remarks: Start DECRemark - 0313332 Prior to Sept, 2004 data translation this spill Lead DEC Field was "SAWYER" Sangesland spoke to Mr. Williamson. Appears to be a neighborhood fight. Next door is a construction site and Mr. Williamson's building has been hit by construction equipment from next door. Fire Dept was called to the site. Mr. Williamson says the problem site address is probably 438 West 19th St (anything below 446 west 19th). He says the site is going to be a new highrise apartment building. Site is already dug 30 ft down with a basement/sub-basement level. Sidewalls have been poured and the foundation walls now rise to street level. Strong smell of diesel at the site. spill closed Ref to #0311002 END DECRemark - 0313332

C13
 SE
 < 1/8
 276 ft.

CONSTRUCTION SITE
438 WEST 19TH ST
MANHATTAN, NY

Site 3 of 5 in cluster C

NY Spills S106127254
 N/A

Relative:
 Higher

Actual:
 13 ft.

NY Spills:
 Site ID: 236116
 Facility Addr2: Not reported
 Facility ID: 0311002
 Spill Number: 0311002
 Facility Type: ER
 SWIS: 3101
 Region of Spill: 2
 Investigator: KMFOLEY
 Referred To: NFA, 4/19/06
 Spill Date: 12/24/03
 Reported to Dept: 12/26/03
 CID: 08
 Spill Cause: Human Error
 Water Affected: Not reported
 Spill Source: Commercial/Industrial
 Spill Notifier: Local Agency
 Cleanup Ceased: / /
 Cleanup Meets Std: False
 Last Inspection: / /
 Recommended Penalty: Penalty Not Recommended
 UST Trust: False
 Spill Class: Known release with minimal potential for fire or hazard. DEC Response. Willing Responsible Party. Corrective action taken.
 Spill Closed Dt: 04/19/06
 Remediation Phase: 0
 Date Entered In Computer: 12/26/03

Map ID
Direction
Distance
Distance (ft.)
Elevation Site

MAP FINDINGS

EDR ID Number
EPA ID Number
Database(s)

CONSTRUCTION SITE (Continued)

S106127254

Spill Record Last Update: 04/19/06
Spiller Name: LABIB NADER
Spiller Company: FUTURE CONDOMINIUM
Spiller Address: 438 WEST 19TH STREET
Spiller City,St,Zip: NEW YORK, NY
Spiller Company: 001
Spiller Phone: (201) 532-9302
Contact Name: LABIB NADER
Contact Phone: (201) 532-9302
DEC Region: 2
Program Number: 0311002
DER Facility ID: 308319
Site ID: 236116
Operable Unit ID: 876247
Operable Unit: 01
Material ID: 499835
Material Code: 0009
Material Name: Gasoline
Case No.: Not reported
Material FA: Petroleum
Quantity: 0.00
Units: Gallons
Recovered: 0.00
Resource Affected: Soil
Oxygenate: True
Site ID: 236116
Operable Unit ID: 876247
Operable Unit: 01
Material ID: 2106574
Material Code: 1213A
Material Name: MTBE (METHYL-TERT-BUTYL ETHER)
Case No.: 01634044
Material FA: Hazardous Material
Quantity: 0.00
Units: Not reported
Recovered: 0.00
Resource Affected: Not reported
Oxygenate: True
DEC Remarks: Start CallerRemark - 0311002 CALLER FOUND Two TANKS IN GROUND ONE THEY RUPTURED WITH MACHINE. UNKNOWN MATERIAL SEEPKING OUT. END CallerRemark - 0311002
Remarks: Start DECRemark - 0311002 12/26/03 11:30 Hrs - Sawyer - Responded to the site to check a minor spill of 35 gallon tank and a larger spill from the removal of the 1500 gallon tank. The project manager who I had spoken to on the phone before I left was not at the site when I arrived. His name is Labib Nader, the superintendent (cell) 201-532-9302 and he would arrive later on after lunch. When he arrived I notified him that the excavator had uncovered two more tanks and they should also be registered before removal. From the latest PBS registration, the two 550 gallon tanks are registered and classified as removed per 1/20/04. 01/26/04 0929 Hrs - Sawyer - Received a call from Richard Parrish of Impact Environmental (631)269-8800, (516)805-8900 who has been retained by the contractor, Breeze International. He was giving the background to a spill reported this morning from the same site. He explained that when the two 550 gallon tanks were removed major petroleum contamination was found. They will remove as much of the contaminated soil as they can and get ground water samples to see the extent of its pollution. 2/17/04 Investigation Plan received. 2/26/04 Investigation report prepared by Impact Env. Gasoline release from the two 550gal USTs has impacted soil and groundwater. 4/19/04

Map ID
 Direction
 Distance
 Distance (ft.)
 Elevation Site

MAP FINDINGS

Database(s) EDR ID Number
 EPA ID Number

CONSTRUCTION SITE (Continued)

S106127254

RAP dated 4/7/04 received. 06/24/04 Transferred from Sawyer to Foley. Reference spills #0311976, 0313332. 6/30/04 Rich Parrish hand-delivered RAP dated 4/15/04. Explained that construction has already begun for the Chelsea Club. Vapor barrier, resistant to petroleum, will be installed. Proposing an SVE/AS system which will be horizontal on the west side of building with two vertical points on north side. They were planning on horizontal piping on north side but changed due to a change in construction details. 7/6/04 Reviewed and conditionally approved RAP. Faxed to R. Parrish. 5/6/05 Update from Hal Benjamin, Impact. Wells installed early in the project were destroyed during construction activities, so the following wells are in place at this time: Horizontal SVE-1, MW-1, and AS-1. Hit refusal on several tries at the location of MW-2. Location is now inside a parking garage with a seven foot ceiling.(requested that we skip this install) Scheduled to drill MW/SVE-2, AS-2, MW/SVE-3, and AS-3 next week(5/9/05). Pilot testing has been completed & equipment has been installed. Piping is in place except to MW/SVE-3, AS-3. Those lines will be connected during drilling event. Looking to start up the system within a month. 5/19/05 Update from H. Benjamin, Impact. MW-1, SVE/MW-2, SVE/MW-3 installed. Gave approval to not install MW-4. Horizontal SVE also already in. Electric to be installed followed by startup. Will notify of startup and send in the data with first report. 5/24/05 System start-up. 9/9/05 Update from H. Benjamin. They started the system at the end of May and just performed the first quarterly sampling. Will send a startup/quarterly report when the lab data comes back. 10/31/05 Start-up procedures and 1Q05 report received. Effluent concentrations were monitored to verify compliance with discharge limits. Once SVE effluent stabilized, sparge was started. Effluent was measured weekly for first five weeks and at least monthly thereafter. Estimated 96lbs of total hydrocarbons removed from 5/24-10/17/05. Groundwater concentrations decreased from 5/19 to 10/6. 1/18/06 Quarterly dated 1/11/06 received. GW concentrations have decreased. Sampling from 12/7/05 showed no VOCs detected in MW-2. Two VOCs were detected in MW-1 but below GWQS. Two VOCs were detected in MW-3 marginally exceeding GWQS. SVE effluent is approaching asymptotic. 4/3/06 3Q06- MW-1 and MW-2/SVE-2 are ND for BTEX and MTBE. MW-3/SVE-3 shows exceedances for xylenes, ethylbenzene, naphthalene and 1,2,4-trimethylbenzene with total BTEX at 330ppb. 4/19/06 NFA issued. END
 DECRemark - 0311002

C14 CONSTRUCTION SITE NY Spills S106125543
SE 438 WEST 19TH ST N/A
< 1/8 MANHATTAN, NY
276 ft.

Site 4 of 5 in cluster C

Relative: NY Spills:
Higher Site ID: 236117
 Facility Addr2: Not reported
Actual: Facility ID: 0311976
13 ft. Spill Number: 0311976
 Facility Type: ER
 SWIS: 3101
 Region of Spill: 2
 Investigator: CESAWYER
 Referred To: Not reported
 Spill Date: 01/26/04
 Reported to Dept: 01/26/04
 CID: 08
 Spill Cause: Other
 Water Affected: Not reported
 Spill Source: Commercial/Industrial

Map ID
 Direction
 Distance
 Distance (ft.)
 Elevation Site

MAP FINDINGS

Database(s) EDR ID Number
 EPA ID Number

MENDON LEASING CORP (Continued)

1004759829

Trans1 Recv Date: 960517
 Trans2 Recv Date: Not reported
 TSD Site Recv Date: 960517
 Part A Recv Date: Not reported
 Part B Recv Date: 960528
 Generator EPA ID: NYR000022665
 Trans1 EPA ID: NYD982741282
 Trans2 EPA ID: Not reported
 TSDF ID: NYD077444263
 Waste Code: D001 - NON-LISTED IGNITABLE WASTES
 Quantity: 01485
 Units: G - Gallons (liquids only)* (8.3 pounds)
 Number of Containers: 027
 Container Type: DM - Metal drums, barrels
 Handling Method: B Incineration, heat recovery, burning.
 Specific Gravity: 077
 Year: 96
 Facility Type: Generator
 EPA ID: NYR000022665
 Facility Name: MENDON LEASING
 Facility Address: 515 W 18TH ST
 Facility City: NEW YORK
 Facility Zip 4: 2822
 Country: Not reported
 County: NEW YORK
 Mailing Name: MENDON LEASING
 Mailing Contact: GEORGE TAKO
 Mailing Address: 515 W 18TH ST
 Mailing City: NEW YORK
 Mailing State: NY
 Mailing Zip: 10011
 Mailing Zip4: 2822
 Mailing Country: USA
 Mailing Phone: N/S

Click this hyperlink while viewing on your computer to access
 2 additional NY MANIFEST: record(s) in the EDR Site Report.

F27 MENDON LEASING CORP.
 WSW 515 WEST 18TH STREET
 < 1/8 NYC, NY
 350 ft.

NY LTANKS S102232664
 NY HIST LTANKS N/A

Relative:
 Lower

Site 3 of 4 in cluster F

Actual:
 10 ft.

LTANKS:
 Site ID: 235191
 Spill Date: 02/07/96
 Facility Addr2: Not reported
 Facility ID: 9514181
 Program Number: 9514181
 SWIS: 3101
 Region of Spill: 2
 Investigator: KSTANG
 Referred To: Not reported
 Reported to Dept: 02/07/96
 CID: 08
 Spill Cause: Tank Test Failure
 Water Affected: Not reported

Map ID
 Direction
 Distance
 Distance (ft.)
 Elevation

MAP FINDINGS

EDR ID Number
 EPA ID Number

MENDON LEASING CORP. (Continued)

S102232664

Spill Source: Institutional, Educational, Gov., Other
 Spill Notifier: Responsible Party
 Cleanup Ceased: / /
 Cleanup Meets Standard: False
 Last Inspection: / /
 Recommended Penalty: Penalty Not Recommended
 UST Involvement: False
 Spill Class: Known release that creates potential for fire or hazard. DEC Response. Willing Responsible Party. Corrective action taken.
 Spill Closed Dt: / /
 Remediation Phase: 1
 Date Entered in Computer: 02/07/96
 Spill Record Last Update: 06/16/06
 Spille Namer: TOM FASINI
 Spiller Company: MENDON LEASING CORP.
 Spiller Phone: (718) 389-2100
 Spiller Extention: Not reported
 Spiller Address: 515 WEST 18TH STREET
 Spiller City,St,Zip: NYC, ZZ
 Spiller County: 001
 Spiller Contact: TOM FASINI
 Spiller Phone: (718) 389-2100
 Spiller Extention: Not reported
 DEC Region: 2
 Program Number: 9514181
 DER Facility ID: 193722
 Site ID: Not reported
 Operable Unit ID: Not reported
 Operable Unit: Not reported
 Material ID: Not reported
 Material Code: Not reported
 Material Name: Not reported
 Case No.: Not reported
 Material FA: Not reported
 Quantity: Not reported
 Units: Not reported
 Recovered: Not reported
 Resource Affected: Not reported
 Oxygenate: Not reported
 Site ID: 235191
 Spill Tank Test: 18964
 Tank Number: 4n5
 Tank Size: 1500
 Test Method: 01
 Leak Rate: 0.00
 Gross Fail: Not reported
 Modified By: Spills
 Last Modified: 10/01/04
 Test Method: Petro-Tite/Petro Comp
 DEC Remarks: Start CallerRemark - 9514181 tank test failiure. END CallerRemark - 9514181
 Remarks: Start DECRemark - 9514181 Prior to Sept, 2004 data translation this spill Lead DEC Field was "MULQUEEN" ORIGINALLY ASSIGNED TO MARTINKAT - FILE TRANSFERRED TO MULQUEEN END DECRemark - 9514181

HIST LTANKS:
 Region of Spill: 2
 Spill Number: 9514181

Map ID
Direction
Distance
Distance (ft.)
Elevation Site

MAP FINDINGS

Database(s) EDR ID Number
EPA ID Number

MENDON LEASING CORP. (Continued)

S102232664

Investigator: MULQUEEN
Caller Name: Not reported
Caller Agency: Not reported
Caller Phone: Not reported
Caller Extension: Not reported
Notifier Name: Not reported
Notifier Agency: Not reported
Notifier Phone: Not reported
Notifier Extension: Not reported
Spill Date: 02/07/1996
Spill Time: 11:30
Reported to Department Date: 02/07/96
Reported to Department Time: 12:40
SWIS: 62
Spiller Contact: TOM FASINI
Spiller Phone: (718) 389-2100
Spiller Extension: Not reported
Spiller Name: MENDON LEASING CORP.
Spiller Address: 515 WEST 18TH STREET
Spiller City,St,Zip: NYC
Facility Contact: TOM FASINI
Facility Phone: (718) 389-2100
Facility Extension: Not reported
Spill Cause: Tank Test Failure
Resource Affectd: On Land
Water Affected: Not reported
Spill Source: Other Non Commercial/Industrial
Spill Notifier: Responsible Party
PBS Number: Not reported
Cleanup Ceased: / /
Cleanup Meets Standard: False
Last Inspection: / /
Recommended Penalty: Penalty Not Recommended
Spiller Cleanup Date: / /
Enforcement Date: / /
Investigation Complete: / /
UST Involvement: False
Spill Class: Known release that creates potential for fire or hazard. DEC Response. Willing Responsible Party. Corrective action taken.
Spill Closed Dt: / /
Date Region Sent Summary to Central Office: / /
Corrective Action Plan Submitted: / /
Date Spill Entered In Computer Data File: 02/07/96
Time Spill Entered In Computer Data File: Not reported
Spill Record Last Update: 10/06/97
Is Updated: False
PBS Number: Not reported
Tank Number: 4n5
Tank Size: 1500
Test Method: Petro-Tite
Leak Rate Failed Tank: 0.00
Gross Leak Rate: Not reported
Material Class Type: Not reported
Quantity Spilled: Not reported
Unkonwn Quantity Spilled: Not reported
Units: Not reported
Quantity Recovered: Not reported

Map ID
 Direction
 Distance
 Distance (ft.)
 Elevation Site

MAP FINDINGS

Database(s) EDR ID Number
 EPA ID Number

MENDON LEASING CORP. (Continued)

S102232664

Unkonwn Quantity Recovered: Not reported
 Material: Not reported
 Class Type: Not reported
 Times Material Entry In File: Not reported
 CAS Number: Not reported
 Last Date: Not reported
 DEC Remarks: ORIGINALLY ASSIGNED TO MARTINKAT - FILE TRANSFERRED TO MULQUEEN
 Spill Cause: tank test failiure.

F28
 WSW
 < 1/8
 350 ft.

515 W 18 ST
 515 WEST 18TH ST
 MANHATTEN, NY

NY Spills S104502660
 NY Hist Spills N/A

Site 4 of 4 in cluster F

Relative:
 Lower

NY Spills:
 Site ID: 178360
 Facility Addr2: Not reported
 Facility ID: 9612012
 Spill Number: 9612012
 Facility Type: ER
 SWIS: 3101
 Region of Spill: 2
 Investigator: KSTANG
 Referred To: Not reported
 Spill Date: 01/06/97
 Reported to Dept: 01/06/97
 CID: 08
 Spill Cause: Unknown
 Water Affected: Not reported
 Spill Source: Commercial/Industrial
 Spill Notifier: Other
 Cleanup Ceased: / /
 Cleanup Meets Std: False
 Last Inspection: / /
 Recommended Penalty: Penalty Not Recommended
 UST Trust: False
 Spill Class: Known release that creates potential for fire or hazard. DEC Response. Willing Responsible Party. Corrective action taken.
 Spill Closed Dt: / /
 Remediation Phase: 1
 Date Entered In Computer: 01/06/97
 Spill Record Last Update: 06/16/06
 Spiller Name: MR RICCIO
 Spiller Company: MENDON LEASING
 Spiller Address: 515 WEST 18TH ST
 Spiller City,St,Zip: MANHATTEN, NY
 Spiller Company: 001
 Spiller Phone: Not reported
 Contact Name: CHRISTOPHER HONOR
 Contact Phone: (516) 485-0000
 DEC Region: 2
 Program Number: 9612012
 DER Facility ID: 149797
 Site ID: 178360
 Operable Unit ID: 1039877
 Operable Unit: 01
 Material ID: 340667

Actual:
 10 ft.

Map ID
Direction
Distance
Distance (ft.)
Elevation Site

MAP FINDINGS

EDR ID Number
EPA ID Number
Database(s)

515 W 18 ST (Continued)

S104502660

Material Code: 0008
Material Name: Diesel
Case No.: Not reported
Material FA: Petroleum
Quantity: 0.00
Units: Gallons
Recovered: 0.00
Resource Affected: Soil
Oxygenate: False
DEC Remarks: Start CallerRemark - 9612012 THE CALLERS COMPANY WAS HIRED TO REPLACE 2 1500 GALLON TANKS WITH 1 4000 GALLON TANK AND THEY DISCOVERED CONTAMINATED SOIL AROUND THE AREA OF THE TANKS - SOIL IS BEING EXCAVATED END CallerRemark - 9612012
Remarks: Start DECRemark - 9612012 Prior to Sept, 2004 data translation this spill Lead DEC Field was "MULQUEEN" 9514181 TANK TEST FAILURE. ORIGINALLY ASSIGNED TO MARTINKAT - FILE TRANSFERRED TO MULQUEEN END DECRemark - 9612012

NY Hist Spills:

Region of Spill: 2
Spill Number: 9612012
Investigator: MULQUEEN
Caller Name: Not reported
Caller Agency: Not reported
Caller Phone: Not reported
Notifier Name: Not reported
Notifier Agency: Not reported
Notifier Phone: Not reported
Spill Date/Time: 01/06/1997 10:15
Reported to Dept Date/Time: 01/06/97 10:58
SWIS: 62
Spiller Name: MENDON LEASING
Spiller Contact: MR RICCIO
Spiller Phone: Not reported
Spiller Contact: CHRISTOPHER HONOR
Spiller Phone: (516) 485-0000
Spiller Address: 515 WEST 18TH ST
Spiller City,St,Zip: MANHATTEN, NY
Spill Cause: Unknown
Reported to Dept: On Land
Water Affected: Not reported
Spill Source: 01
Spill Notifier: Other
PBS Number: Not reported
Cleanup Ceased: / /
Cleanup Meets Std: False
Last Inspection: / /
Recommended Penalty: Penalty Not Recommended
Spiller Cleanup Dt: / /
Enforcement Date: / /
Invstgn Complete: / /
UST Involvement: False
Spill Class: Known release that creates potential for fire or hazard. DEC Response. Willing Responsible Party. Corrective action taken.
Spill Closed Dt: / /
Corrective Action Plan Submitted: / /
Date Region Sent Summary to Central Office: / /
Date Spill Entered In Computer Data File: 01/06/97

Map ID
 Direction
 Distance
 Distance (ft.)
 Elevation Site

MAP FINDINGS

Database(s) EDR ID Number
 EPA ID Number

515 W 18 ST (Continued)

S104502660

Date Spill Entered in Computer Data File: Not reported
 Update Date: 10/06/97
 Is Updated: False
 PBS Number: Not reported
 Tank Number: Not reported
 Tank Size: Not reported
 Test Method: Not reported
 Leak Rate Failed Tank: Not reported
 Gross Leak Rate: Not reported
 Material Class Type: Petroleum
 Quantity Spilled: 0
 Unkonwn Quantity Spilled: True
 Units: Gallons
 Quantity Recovered: 0
 Unkonwn Quantity Recovered: False
 Material: DIESEL
 Class Type: DIESEL
 Times Material Entry In File: 10625
 CAS Number: Not reported
 Last Date: 19940728
 DEC Remarks: 9514181 TANK TEST FAILURE. ORIGINALLY ASSIGNED TO MARTINKAT - FILE TRANSFERRED TO MULQUEEN
 Remark: THE CALLERS COMPANY WAS HIRED TO REPLACE 2 1500 GALLON TANKS WITH 1 4000 GALLON TANK AND THEY DISCOVERED CONTAMINATED SOIL AROUND THE AREA OF THE TANKS - SOIL IS BEING EXCAVATED

G29 EMPIRE CITY SUBWAY CO LTD
 NNE 177-183 10TH AVE
 < 1/8 NEW YORK, NY 10011
 353 ft.

RCRA-SQG 1000912482
 FINDS NY0000821736
 NY MANIFEST

Site 1 of 2 in cluster G

Relative: RCRAInfo:
 Equal Owner: EMPIRE CITY SUBWAY CO LTD
 (212) 242-1173
 Actual: EPA ID: NY0000821736
 11 ft. Contact: Not reported
 Classification: Small Quantity Generator
 TSDF Activities: Not reported
 Violation Status: No violations found

FINDS:
 Other Pertinent Environmental Activity Identified at Site

RCRAInfo is a national information system that supports the Resource Conservation and Recovery Act (RCRA) program through the tracking of events and activities related to facilities that generate, transport, and treat, store, or dispose of hazardous waste. RCRAInfo allows RCRA program staff to track the notification, permit, compliance, and corrective action activities required under RCRA.

NY MANIFEST:
 Document ID: NJA2701607

APPENDIX B

Soil Boring Logs



BORING NO. SB/MW-1

PROJECT: 515 West 18th Street

SHEET: 1 of 1

CLIENT: MENDON

JOB NO:

BORING CONTRACTOR: Aquifer Drilling & Testing

BORING LOCATION: See Attachment 1

Ground water level

GROUND ELEVATION: N/A

DATE	TIME	LEVEL	TYPE	TYPE	Sonic drill	HP	MC	TUBE
1/23/2012		13	Estimated	DIA	4"		2"	
2/2/2010	10:05	8.05	Interface Meter	WT				
2/15/2012	16:17	8.39	Interface Meter	FALL				

DATE STARTED: 1/23/2012

DATE FINISHED: 1/23/2012

DRILLER: Thomas Schelder

GEOLOGIST: Vladimir Ortiz

REVIEWED BY: William Czelusta

*POCKET PENETROMETER READING

DEPTH	STRATA	SAMPLE				DESCRIPTION				REMARKS	
		NO.	TYPE	BLOWS PER 6"	RECOVERY RQD %	COLOR	CONSISTENCY HARDNESS	MATERIAL DESCRIPTION	CLASS USCS	PID	MOISTURE
0'-5'		1	HC	N/A	Hand Cleared	Brown	Soft	4" Concrete slab 4" Pea gravel 36" Fine to medium and silty sand, some gravel (fill material) 12" Fine to medium and coarse sands, some gravel, trace of silt.	SW	BG	Dry
5'-10'		2	MC	N/A	40%	Brown to Black (stained)	Soft	16" Fine to medium and coarse sands, some gravel, trace of silt. 8" Fine to medium sand and silt. (strong petroleum odor and soil discoloration/stain)	SW	1185	Dry to moist to very moist
10'-15'		3	MC	N/A	20%	Black (stained) to Dark Brown	Medium Stiff	6" Fine to medium sand and silt. 6" Fine to medium sand and silt, some gravel.	SM	1024	Very moist to wet
15'-20'		4	MC	N/A	47%	Light Brown to Brown	Very soft	12" Fine to medium sand and coarse sand, some gravel, trace of silt. 16" Silty clay to clay	SC	0.3	Wet to moist

PROJECT NO: 515 West 18th Street

BORING NO

SB/MW-1

COMMENTS: A mixture of fill material and gravelly sands were found throughout the first 10 feet. Collected soil sample at 8.0 to 9.0 feet below ground surface (bgs). Samples will be analyze for Full List VOCs/SVOCs. A groundwater monitoring well was installed to a total depth of 20' feet (bgs). The well was constructed of 2' schedule 40 PVC piping, 15' of screen and 5' of riser. The well was sand packed with coarse sand to 5' feet bgs and seal with Bentonite to 1' feet bgs. The well was flush mounted and finished with quick setting concrete.



BORING NO. SB/MW-2

PROJECT: 515 West 18th Street

SHEET: 1 of 1

CLIENT: MENDON

JOB NO:

BORING CONTRACTOR: Aquifer Drilling & Testing

BORING LOCATION: See Attachment 1

Ground water level

GROUND ELEVATION: N/A

DATE	TIME	LEVEL	TYPE	TYPE	CAS	SAMPLER	CORE	TUBE
1/23/2012		13	Estimated	DIA	Sonic drill/H.S.A.	HP	MC/SP	
2/2/2012	14:05	8.7	Interface Meter	WT	4"			
2/15/2012	16:35	9.09	Interface Meter	FALL				

DATE STARTED: 1/23/2012

DATE FINISHED: 1/25/2012

DRILLER: Thomas Schelder/Christopher Stratton

GEOLOGIST: Vladimir Ortiz

REVIEWED BY: William Czelusta

DEPTH	STRATA	SAMPLE				DESCRIPTION						REMARKS	
		NO.	TYPE	BLOWS PER 8"	RECOVERY RQD %	COLOR	CONSISTENCY HARDNESS	MATERIAL DESCRIPTION	CLASS USCS	PID	MOISTURE		
0'-5'		1	HC	N/A	Hand Cleared	Gray to Brown	Soft	6" Concrete slab 6" Pea gravel 8" Pea gravel and silt 28" Fine to medium sand and silt, some gravel	SW	BG	Dry		
5'-10'		2	MC	N/A	40%	Dark Brown/Black (stained) to Brown	Soft to very soft	20" Fine to medium sand and gravel, some silt. (petroleum odor and soil discoloration/stain) 4" Fine to medium and silt, trace of gravel	SW	98	Moist to very moist		
10'-15'		3	MC	N/A	17%	Brown	Very Soft	2" Fine to medium and silt, trace of gravel. 8" Fine to medium sand and gravel, some silt.	SM	8.7	Wet		
15'-20'		4	MC	N/A	60%	Brown to dark brown	Very Soft	36" Fine to medium sand and silty clay, some gravel. (gray clay was observed on the outside walls of the sampler but it was not recover on the sampler).	SC	BG	Wet		

PROJECT NO: 515 West 18th Street BORING NO SB/MW-2

COMMENTS: A mixture of fill material and gravely sands were found throughout the first 10 feet. Collected soil sample at 8.0 to 9.0 feet below ground surface (bgs). Samples will be analyze for Full List VOCs/SVOCs. A groundwater monitoring well was installed to a total depth of 20' feet (bgs) on 1-25-12. The well was constructed of 2' schedule 40 PVC piping, 15' of screen and 5' of riser. The well was sand packed with coarse sand to 5' feet bgs and seal with Bentonite to 1' feet bgs. The well was flush mounted and finished with quick setting concrete.



BORING NO. SB/MW-3

PROJECT: 515 West 18th Street

SHEET: 1 of 1

CLIENT: MENDON

JOB NO:

BORING CONTRACTOR: Aquifer Drilling & Testing

BORING LOCATION: See Attachment 1

Ground water level

GROUND ELEVATION: N/A

DATE	TIME	LEVEL	TYPE	TYPE	CAS	H.S.A.	HP	SP	TUBE
1/25/2012		11	Estimated	DIA		6"		2"	
2/2/2012	13:20	8.9	Interface Meter	WT					
2/15/2012	16:30	9.27	Interface Meter	FALL					

DATE STARTED: 1/25/2012

DATE FINISHED: 1/25/2012

DRILLER: Christopher Stratton

GEOLOGIST: Vladimir Ortiz

REVIEWED BY: William Czelusta

DEPTH	STRATA	SAMPLE				DESCRIPTION				REMARKS	
		NO	TYPE	BLOWS PER 6"	RECOVERY ROD %	COLOR	CONSISTENCY HARDNESS	MATERIAL DESCRIPTION	CLASS USCS	PID	MOISTURE
0'-3'		1	HC	N/A	Hand cleared	Black to gray to dark brown	Soft	3" Asphalt 7" Concrete slab 26" Fine to medium sand and silt, some coarse sand, trace of gravel (some petroleum odor and soil is slightly stained)	SW	775	Dry
3'-5'		2	SP	6	5	50%	Dark brown	8" Fine to medium sand and silt, some coarse sand. 4" Fine to medium sand and coarse sand, some silt. (petroleum odor and soil stained)	SW	1395	Dry
				7	8						
5'-7'		3	SP	8	8	50%	Brown	4" Fine to medium sand and coarse sand, some silt. 8" Fine to medium sand and silt, trace of gravel.	SW	1485	Moist
				5	7						
7'-9'		4	SP	4	7	17%	Brown	4" Fine to medium sand and coarse sand, some silt.	SW	86	Very moist
				5	4						
9'-11'		5	SP	5	4	25%	Brown	6" Fine to medium sand and coarse sand, some silt.	SW	875	Very moist to Wet
				4	4						
11'-13'		6	SP	6	3	25%	Brown	6" Fine to medium sand and coarse sand, some silt.	SW	217	Wet
				4	3						
13'-15'		7	SP	2	5	25%	Brown	2" Fine sand and silt. 4" Medium to coarse sand, some fine sand, trace of silt	SW	73	Wet
				5	4						
15'-17'		8	SP	5	4	33%	Brown to black	8" Medium to coarse sand, some fine sand, trace of silt. (some petroleum odor and staining)	SW	218	Wet
				3	3						
17'-19'		9	SP	6	7	58%	Brown to black/gray	8" Medium to coarse sand, some fine sand, trace of silt. 6" Silty clay	SM	115	Wet to moist
				7	5						
19'-20'		10	SP			17%	Black/gray	4" Silty clay	SC	BG	Moist

PROJECT NO: 515 West 18th Street

BORING NO SB/MW-3

COMMENTS: A mixture of fill material and gravelly sands were found throughout the first 5 feet. Collected soil sample at 6.0 to 6.5 feet below ground surface (bgs). Samples will be analyze for Full List VOCs/SVOCs. A groundwater monitoring well was installed to a total depth of 20' feet (bgs). The well was constructed of 2' schedule 40 PVC piping, 15' of screen and 5' of riser. The well was sand packed with coarse sand to 5' feet bgs and seal with Bentonite to 1' feet bgs. The well was flush mounted and finished with quick setting concrete.



PROJECT: 515 West 18th Street

BORING NO. SB/MW-4

SHEET: 1 of 1

CLIENT: MENDON

JOB NO:

BORING CONTRACTOR: Aquifer Drilling & Testing

BORING LOCATION: See Attachment 1

Ground water level

GROUND ELEVATION: N/A

DATE	TIME	LEVEL	TYPE	TYPE	CAS	H.S.A.	SAMPLER	CORE	TUBE
1/27/2012		11	Estimated	DIA		6"	HP	SP	
2/2/2012	12:40	8.7	Interface Meter	WT					
2/15/2010	16:27	9.02	Interface Meter	FALL					

DATE STARTED: 1/27/2012

DATE FINISHED: 1/27/2012

DRILLER: Christopher Stratton

GEOLOGIST: Vladimir Ortiz

REVIEWED BY: William Czelusta

DEPTH	STRATA	SAMPLE				DESCRIPTION				REMARKS		
		NO.	TYPE	BLOWS PER 6"	RECOVERY ROD %	COLOR	CONSISTENCY HARDNESS	MATERIAL DESCRIPTION	CLASS USCS	PID	MOISTURE	
0'-3'		1	HC	N/A	Hand cleared	Black to gray to brown	Soft	2" Asphalt 5" Concrete slab 6" Pea gravel 26" Fine to medium sand and grave, trace of silt	SW	78	Dry	
3'-5'		2	SP	1	25%	Dark Brown to orange	Soft	6" Fine to medium sand and silt, some gravel	SW	20	Dry	
				2								3
5'-7'		3	SP	4	33%	Dark brown	Soft	4" Fine to medium sand and silt, some gravel. 4" Fine to medium sand, some silt (fill like material, wood, red brick, glass)	SW	14	Dry	
				1								3
7'-9'		4	SP	10	33%	Brown	Stiff	8" Fine to medium sand, some silt (fill like material, red brick, wood glass) (slight petroleum smell)	SW	217	Moist	
				7								6
9'-11'		5	SP	7	16%	Brown	Stiff	4" Fine to medium sand, some silt (fill like material, red brick, wood glass) (slight petroleum smell)	SW	22	Moist	
				2								2
11'-13'		6	SP	2	42%	Brown	Soft	10" Silty fine to medium sand, some gravel. (some petroleum odor)	SW	50	Wet	
				1								2
13'-15'		7	SP	2	50%	Brown	Soft	12" Silty fine to medium sand, trace of coarse	SW	17	Wet	
				3								3
15'-17'		8		4	67%	Brown	Very soft	16" Fine to medium sand and coarse sand, trace of silt.	SW	5	Wet	
				4								3
17'-19'		9		3	16%	Brown	Very soft	4" Fine to medium sand and coarse sand, trace of silt.	SW	3	Wet	
				1								1
19'-20'		10	SP	2	No recovery	Black/gray	Very soft	Gray clay was observed on the augers but it was not recover on the split spoon sampler.	SC	BG	Moist	

PROJECT NO: 515 West 18th Street

BORING NO

SB/MW-4

COMMENTS: A mixture of fill material and gravely sands were found throughout the first 10 feet. Collected soil sample at 7.0 to 8.0 feet below ground surface (bgs). Samples will be analyze for Full List VOCs/SVOCs. A groundwater monitoring well was installed to a total depth of 20' feet (bgs). The well was constructed of 2' schedule 40 PVC piping, 15' of screen and 5' of riser. The well was sand packed with coarse sand to 5' feet bgs and seal with Bentonite to 1' feet bgs. The well was flush mounted and finished with quick setting concrete.



PROJECT: 515 West 18th Street

BORING NO. SB/MW-5

SHEET: 1 of 1

CLIENT: MENDON

JOB NO:

BORING CONTRACTOR: Aquifer Drilling & Testing

BORING LOCATION: See Attachment 1

Ground water level

GROUND ELEVATION: N/A

DATE	TIME	LEVEL	TYPE	TYPE	CAS	SAMPLER	CORE	TUBE
1/26/2012		11	Estimated	DIA	H.S.A.	HP	SP	
2/2/2010	11:14	8.7	Interface Meter	WT	6"			
2/15/2012	16:25	8.66	Interface Meter	FALL				

DATE STARTED: 1/26/2012

DATE FINISHED: 1/26/2012

DRILLER: Christopher Stratton

GEOLOGIST: Vladimir Ortiz

REVIEWED BY: William Czelusta

*POCKET PENETROMETER READING

DEPTH	STRATA	SAMPLE				DESCRIPTION				REMARKS	
		NO.	TYPE	BLOWS PER 6"	RECOVERY RQD %	COLOR	CONSISTENCY HARDNESS	MATERIAL DESCRIPTION	CLASS USCS	PID	MOISTURE
0'-3'		1	HC	N/A	Hand cleared	Brown	Soft	4" Asphalt 10" Concrete slab 6" Pea gravel. 16" Fine to medium sand and silt, trace of gravel.	SW	29	Dry
3'-5'		2	SP	8	33%	Brown/orange	Soft	8" Fine to medium sand and silt, some gravel (fill material, glass, brick wood)	SW	13	Dry
				4							
5'-7'		3	SP	3	50%	Brown/orange	Soft	8" Fine to medium sand and silt, some gravel (fill material, glass, brick wood)	SW	8	Dry
				9							
7'-9'		4	SP	9	17%	Brown/black	Soft	4" Fine to medium sand and silt, some gravel (some petroleum odor and stained soils)	SW	1160	Dry to moist
				6							
9'-11'		5	SP	6	67%	Brown to black	Soft	4" Fine to medium sand and silt, trace of gravel. 12" Fine to medium sand, some silt (petroleum odor, stained and visible sheen on saturated soil)	SW	1658	Moist to Wet
				2							
11'-13'		6	SP	2	33%	Dark Brown/Black	Very soft	8" Fine to medium sand and coarse sand, some gravel, trace of silt (some petroleum odor and discolored soil)	SW	1014	Wet
				4							
13'-15'		7	SP	1	17%	Dark Brown/Black	Very soft	4" Fine to medium sand and coarse sand, some gravel, trace of silt (some petroleum odor and discolored soil)	SW	267	Wet
				2							
15'-17'		8	SP	0	17%	Dark Brown/Black	Very soft	4" Fine to medium sand and coarse sand, some gravel, trace of silt (some petroleum odor and discolored soil)	SW	23	Wet
				1							
17'-19'		9	SP	2	33%	Brown	Very soft	8" Medium to coarse sand and fine sand, trace of silt. (some petroleum odor).	SW	61	Wet
				4							
19'-20'		10	SP	2	No recovery	Black/gray	Very soft	Gray clay was observed on the augers but it was not recovered on the split spoon sampler.	SC	BG	Moist

PROJECT NO: 515 West 18th Street

BORING NO

SB/MW-5

COMMENTS: A mixture of fill material and gravelly sands were found throughout the first 8 feet. Collected soil sample at 9.0 to 9.5 feet below ground surface (bgs). Samples will be analyze for Full List VOCs/SVOCs. A groundwater monitoring well was installed to a total depth of 20' feet (bgs). The well was constructed of 2' schedule 40 PVC piping, 15' of screen and 5' of riser. The well was sand packed with coarse sand to 5' feet bgs and seal with Bentonite to 1' feet bgs. The well was flush mounted and finished with quick setting concrete. Ground water level at 8.66 feet bgs



BORING NO. SB/MW-6

PROJECT: 515 West 18th Street

SHEET: 1 of 1

CLIENT: MENDON

JOB NO:

BORING CONTRACTOR: Aquifer Drilling & Testing

BORING LOCATION: See Attachment 1

Ground water level

GROUND ELEVATION: N/A

DATE	TIME	LEVEL	TYPE	TYPE	CAS	H.S.A.	SAMPLER	CORE	TUBE
1/26/2012		11	Estimated			6"	HP	SP	2"
2/2/2012	10:37	9.3	Interface Meter	WT					
2/15/2012	16:20	9.56	Interface Meter	FALL					

DATE STARTED: 1/26/2012

DATE FINISHED: 1/26/2012

DRILLER: Christopher Stratton

GEOLOGIST: Vladimir Ortiz

REVIEWED BY: William Czelusta

*POCKET PENETROMETER READING

DEPTH	STRATA	SAMPLE					DESCRIPTION					REMARKS	
		NO.	TYPE	BLOWS PER 6"		RECOVERY ROD %	COLOR	CONSISTENCY HARDNESS	MATERIAL DESCRIPTION	CLASS USCS	PID	MOISTURE	
				7	8								
0'-3'		1	HC	N/A		Hand cleared	Dark brown	Soft	4" Asphalt 4" Pea gravel 28" Fine to medium sand and silt, some gravel. (some petroleum odor)	SW	20.9	Dry	
3'-5'		2	SP	7	8	33%	Dark brown	Soft	8" Fine to medium sand and silt, some gravel.	SW	11.6	Dry	
				8	10								
5'-7'		3	SP	9	7	33%	Dark brown	Soft	8" Fine to medium sand and silt, some gravel.	SW	7.4	Moist	
				7	7								
7'-9'		4	SP	10	15	No recovery	Dark brown	Soft	Fine to medium sand and silt, some gravel.	SW	BG	Moist	
				12	12								
9'-11'		5	SP	12	12	16%	Dark brown	Soft	4" Fine to medium sand and silt, some gravel (some petroleum odor)	SW	795	Moist to very moist	
				10	4								
11'-13'		6	SP	7	7	25%	Brown to black	Very soft	6" Fine to medium sand and silt, trace of gravel (some petroleum odor and staining)	SW	878	Wet	
				6	4								
13'-15'		7	SP	7	7	16%	Brown	Very soft	4" Fine to medium sand and coarse sand, trace of gravel. (slight petroleum odor)	SW	57	Wet	
				6	4								
15'-17'		8	SP	5	5	42%	Brown	Very soft	10" Medium to coarse sand, some fine sand, trace of silt (some petroleum odor)	SW	270	Wet	
				6	5								
17'-19'		9	SP	5	6	50%	Brown	Very soft	12" Fine to medium sand and coarse sand, some gravel, trace of silt.	SW	117	Wet	
				5	5								
19'-20'		10	SP	4	2	No recovery	Black/gray	Very soft	Gray clay was observed on the augers but it was not recover on the split spoon sampler.	SC	BG	Moist	

PROJECT NO: 515 West 18th Street BORING NO SB/MW-6

COMMENTS: A mixture of fill material and gravelly sands were found throughout the first 7 feet. Collected soil sample at 10.0 to 10.5 feet below ground surface (bgs). Samples will be analyze for Full List VOCs/SVOCs. A groundwater monitoring well was installed to a total depth of 20' feet (bgs). The well was constructed of 2' schedule 40 PVC piping, 15' of screen and 5' of riser. The well was sand packed with coarse sand to 5' feet bgs and seal with Bentonite to 1' feet bgs. The well was flush mounted and finished with quick setting concrete. Ground water level at 9.56 feet bgs



BORING NO. SB-7

PROJECT: 515 West 18th Street

SHEET: 1 of 1

CLIENT: MENDON

JOB NO:

BORING CONTRACTOR: Aquifer Drilling & Testing

BORING LOCATION: See Attachment 1

Ground water level

GROUND ELEVATION: N/A

DATE	TIME	LEVEL	TYPE	TYPE	H.S.A.	HP	SP	TUBE
1/27/2012		12	Estimated	DIA	6"		2"	
				WT				
				FALL				

DATE STARTED: 1/27/2012

DATE FINISHED: 1/27/2012

DRILLER: Christopher Stratton

GEOLOGIST: Vladimir Ortiz

REVIEWED BY: William Czelusta

*POCKET PENETROMETER READING

DEPTH	STRATA	SAMPLE				DESCRIPTION				REMARKS	
		NO.	TYPE	BLOWS PER 5"	RECOVERY RQD %	COLOR	CONSISTENCY HARDNESS	MATERIAL DESCRIPTION	CLASS USCS	PID	MOISTURE
0'-3'		1	HC	N/A	Hand cleared	Black to gray to brown	Soft	3" Asphalt 7" Concrete slab 2" Pea gravel 26" Fine to medium sand and silt, some gravel.	SW	28	Dry
3'-5'		2	SP	3	16%	Dark brown	Soft	4" Fine to medium sand and silt, some gravel.	SW	78	Dry
				3							
5'-7'		3	SP	16	25%	Black/Gray/Red	Soft	Fill like material (concrete, red brick, glass, gravel, wood)	SW	18	Dry to moist
				15							
7'-9'		4	SP	6	67%	Black/Pink	Soft to Stiff	12" Fine to medium sand and silt, trace of gravel. (some petroleum odor and stained soil) 4" Boulder debris (Quartz), medium sand.	SW	348	Moist to Dry
				9							
9'-11'		5	SP	13	25%	Black/Gray/Red	Soft	2" Boulder debris (Quartz), medium sand. Fill like material. (concrete, red brick, glass, gravel, wood)	SW	112	Dry to moist
				9							
11'-13'		6	SP	2	42%	Brown/Green	Very soft	10" Fine to medium sand and silt (some petroleum odor and soil staining, green)	SW	25	Wet
				3							
13'-15'		7	SP	3	No recovery	Brown/Green	Very soft	Fine to medium sand and silt	SW	BG	Wet
				2							
15'-17'		8	SP	2	67%	Brown	Very soft	4" Fine sand and silt. 4" Fine to medium sand, some silt. 4" Coarse to medium sand some fine sand. 4" Fine to medium sand and silt.	SW	6	Wet
				2							
17'-19'		9	SP	2	8%	Brown	Very soft	2" Fine to medium sand and silt, trace of gravel	SW	6	Wet
				4							
19'-20'		10	SP	2	16%	Brown	Very soft	4" Fine to medium sand and silt.	SW	34	Wet

PROJECT NO: 515 West 18th Street

BORING NO

SB-7

COMMENTS: A mixture of fill material and gravelly sands were found throughout the first 10 feet. Collected soil sample at 7.0 to 8.0 feet below ground surface (bgs). Samples will be analyze for Full List VOCs/SVOCs.



BORING NO. SB-8

PROJECT: 515 West 18th Street

SHEET: 1 of 1

CLIENT: MENDON

JOB NO:

BORING CONTRACTOR: Aquifer Drilling & Testing

BORING LOCATION: See Attachment 1

Ground water level

GROUND ELEVATION: N/A

DATE	TIME	LEVEL	TYPE	TYPE	CAS	SAMPLER	CORE	TUBE
1/27/2012		11	Estimated	DIA	H.S.A. 6"	HP	SP	2"
				WT				
				FALL				

DATE STARTED: 1/27/2012

DATE FINISHED: 1/27/2012

DRILLER: Christopher Stratton

GEOLOGIST: Vladimir Ortiz

REVIEWED BY: William Czelusta

DEPTH	STRATA	SAMPLE				DESCRIPTION				REMARKS		
		NO.	TYPE	BLOWS PER 6"	RECOVERY ROD %	COLOR	CONSISTENCY HARDNESS	MATERIAL DESCRIPTION	CLASS USCS	PID	MOISTURE	
0'-3'		1	HC	N/A	Hand cleared	Black to gray to brown	Soft	4" Asphalt 5" Concrete slab. 3" Pea gravel 26" Fine to medium sand and silt.	SW	2	Dry	
3'-5'		2	SP	28	42%	Brown	Medium stiff	4" Fine to medium sand and silt. 4" Boulder debris (gray Schist). 2" Fine to medium sand, some silt.	SW	2	Dry	
				10								6
5'-7'		3	SP	14	8%	Gray	Stiff	2" Boulder debris (gray Schist)	N/A	2	Dry	
7'-9'		4	SP	7	17%	Brown	Soft	4" Fine to medium sand and silt, some coarse. (some wood debris was observed)	SW	124	Moist	
				3								3
9'-11'		5	SP	5	25%	Brown	Soft	6" Fine to medium sand and silt, some coarse. (some wood debris was observed)	SW	124	Moist to very moist	
				2								2
11'-13'		6	SP	4	8%	Brown	Soft	2" Fine to medium sand and silt, trace of gravel.	SW	2	Wet	
				2								2
13'-15'		7	SP	5	17%	Brown	Very soft	4" Fine to medium and silt.	SW	20	Wet	
				2								1
15'-17'		8	SP	8	50%	Brown	Very soft	12" Medium to coarse sand and silt, some fine sand.	SW	3	Wet	
				3								3
17'-19'		9	SP	2	25%	Brown to gray/black	Very soft	2" Silty fine sand 2" Silty Clay 2" Clay	SC	3	Wet to moist	
				1								1
19'-20'		10	SP	1	25%	Gray	Very soft	6" Clay	SC	2	Moist	

PROJECT NO: 515 West 18th Street

BORING NO

SB-8

COMMENTS: A mixture of fill material and gravelly sands were found throughout the first 10 feet. Collected soil sample at 8.0 to 9.0 feet below ground surface (bgs). Samples will be analyze for Full List VOCs/SVOCs.

APPENDIX C

Monitoring Well Construction Details

DRILLING SUMMARY

Geologist:
Vladimir Ortiz
Drilling Company:
Aquifer Drilling & Testing

Drillers:
Thomas Schelder
Rig Make/Model:
Compact Rotor Sonic 17-C
Date:
1/23/2012

GEOLOGIC LOG



depth(ft.)	lithology
0'-10'	Fill material, gravelly fine to medium sand and silts
10'-18'	Fine to medium sand and silt
18'-21'	Silty Clay and Clay

WELL DESIGN

CASING MATERIAL		SCREEN MATERIAL		FILTER MATERIAL	
Surface:	Steel flush mount	Type:	Schedule 40	Type:	#2 Sand Setting:
Monitor:	2" diameter PVC	Slot Size:	10	SEAL MATERIAL	
				Type:	Medium Setting:
				Bentonite Chips	

COMMENTS:

LEGEND

-  Cement/Bentonite Grout
-  Bentonite Seal
-  Silica Sandpack

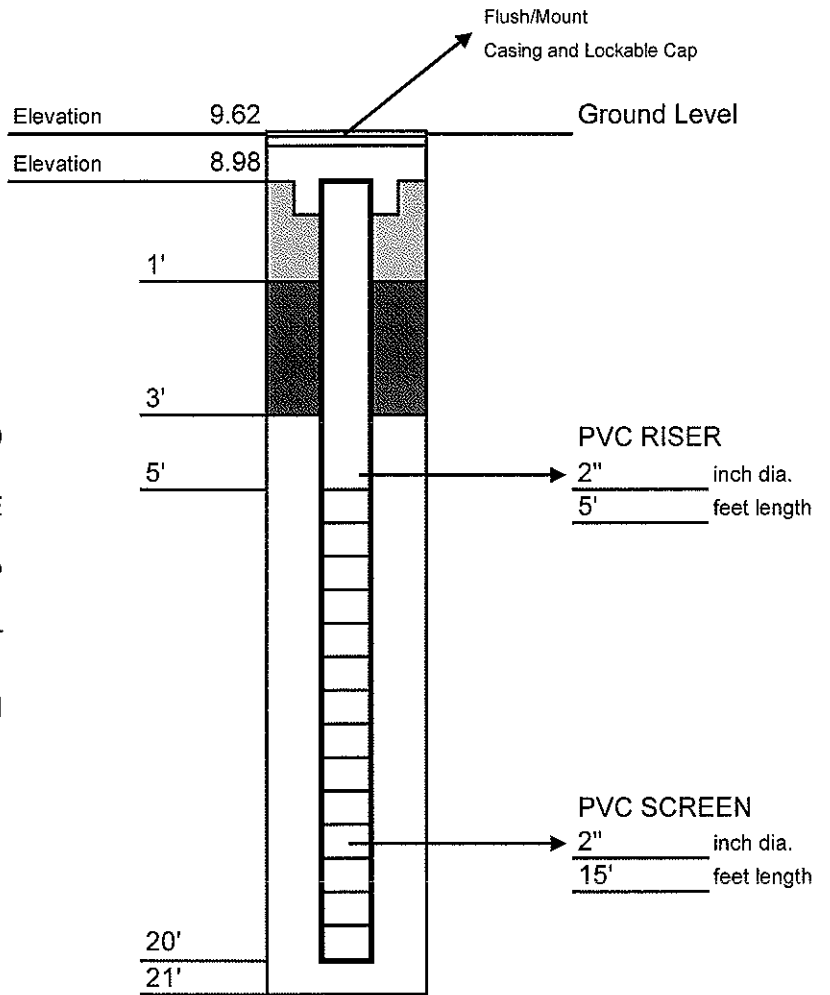

	Project No.:
	Well Number: MW1

MONITORING WELL
CONSTRUCTION DETAILS

DRILLING SUMMARY

Geologist:
Vladimir Ortiz
Drilling Company:
Aquifer Drilling & Testing

Drillers:
Christopher Stratton
Rig Make/Model:
Acker ATV Hallow Stem Auger
Date:
1/25/2012

GEOLOGIC LOG



depth(ft.)	lithology
0'-10'	Fill material, gravelly fine to medium sand and silts
10'-18'	Fine to medium sand and silt
18'-21'	Silty Clay and Clay

WELL DESIGN

CASING MATERIAL		SCREEN MATERIAL	FILTER MATERIAL
Surface:	Steel flush mount	Type: Schedule 40	Type: #2 Sand Setting:
Monitor:	2" diameter PVC	Slot Size: 10	SEAL MATERIAL Type: Medium Setting: Bentonite Chips

COMMENTS:

LEGEND

-  Cement/Bentonite Grout
-  Bentonite Seal
-  Silica Sandpack

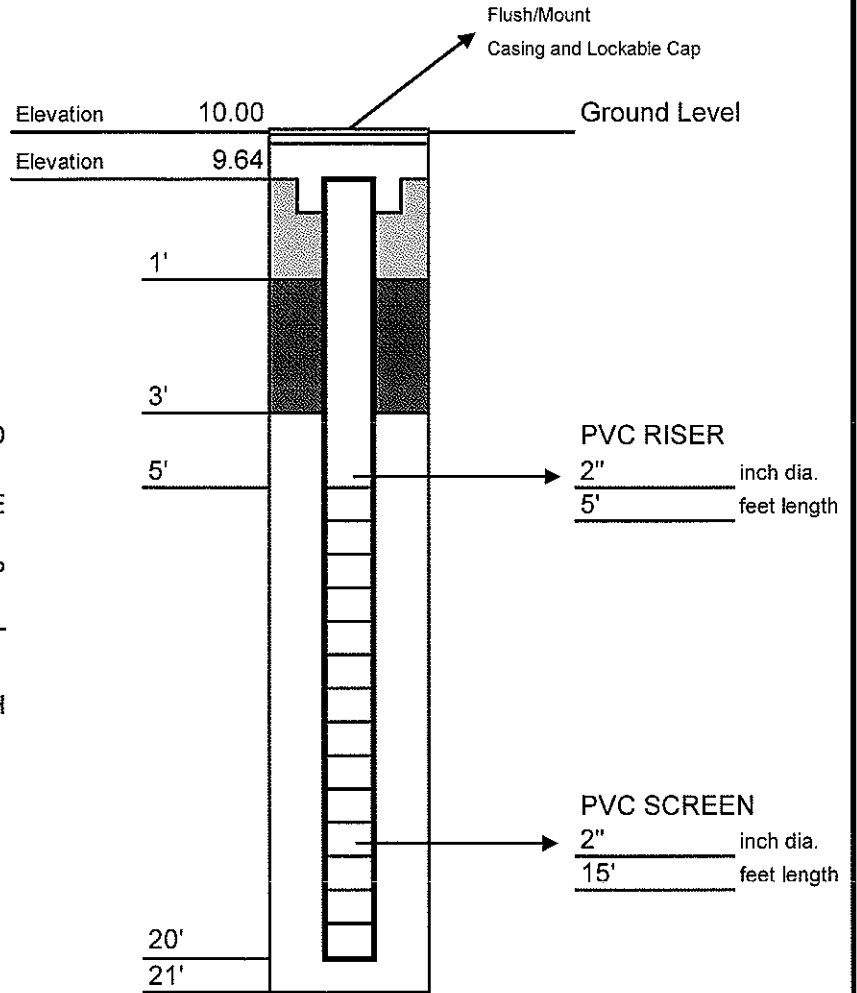

	Project No.:
	Well Number: MW2

MONITORING WELL
CONSTRUCTION DETAILS

DRILLING SUMMARY

Geologist:
Vladimir Ortiz
Drilling Company:
Aquifer Drilling & Testing

Drillers:
Christopher Stratton
Rig Make/Model:
Acker ATV Hallow Stem Auger
Date:
1/25/2012

GEOLOGIC LOG



depth(ft.)	lithology
0'-7'	Fill material, gravely fine to medium sand, some silt
7'-19'	Fine to medium sands and silt.
19'-21'	Silty Clay and Clay

WELL DESIGN

CASING MATERIAL		SCREEN MATERIAL	FILTER MATERIAL
Surface:	Steel flush mount	Type: Schedule 40	Type: #2 Sand Setting:
Monitor:	2" diameter PVC	Slot Size: 10	SEAL MATERIAL Type: Medium Setting: Bentonite Chips

COMMENTS:

LEGEND

-  Cement/Bentonite Grout
-  Bentonite Seal
-  Silica Sandpack

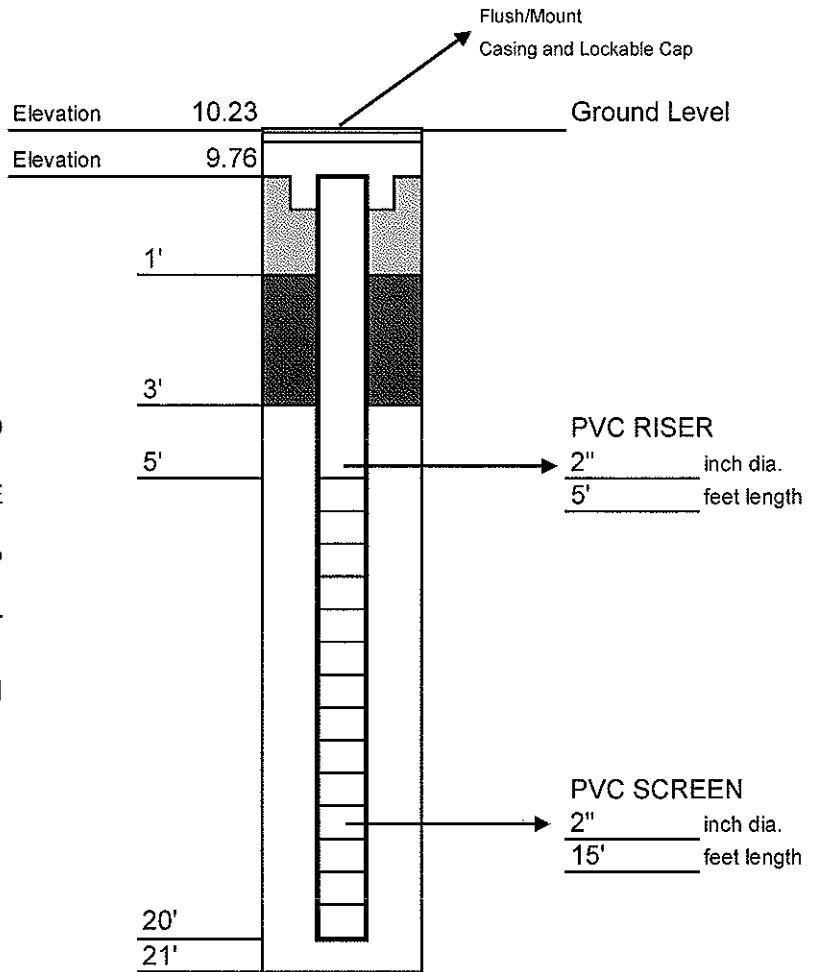

MONITORING WELL
CONSTRUCTION DETAILS

Project No.:

Well Number **MW3**

DRILLING SUMMARY

Geologist:
Vladimir Ortiz
Drilling Company:
Aquifer Drilling & Testing

Drillers:
Christopher Stratton
Rig Make/Model:
Acker ATV Hallow Stem Auger
Date:
1/27/2012

GEOLOGIC LOG



depth(ft.)	lithology
0'-11'	Fill material, gravelly fine to medium sand, some silt
11'-19'	Fine to medium sands and silt.
19'-21'	Silty Clay and Clay

WELL DESIGN

CASING MATERIAL		SCREEN MATERIAL	FILTER MATERIAL
Surface:	Steel flush mount	Type: Schedule 40	Type: #2 Sand Setting:
Monitor:	2" diameter PVC	Slot Size: 10	SEAL MATERIAL Type: Medium Setting: Bentonite Chips

COMMENTS:

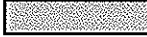
LEGEND

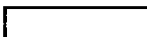
-  Cement/Bentonite Grout
-  Bentonite Seal
-  Silica Sandpack

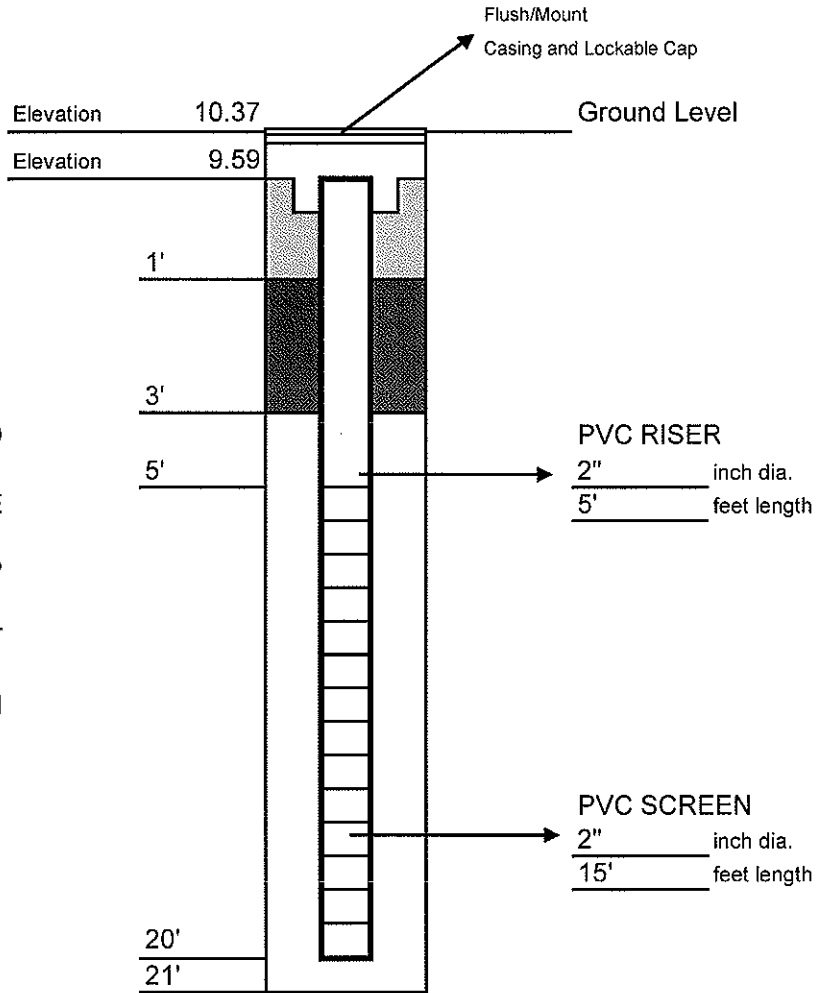

MONITORING WELL
CONSTRUCTION DETAILS

Project No.:

Well Number: **MW4**

DRILLING SUMMARY

Geologist:

Vladimir Ortiz

Drilling Company:

Aquifer Drilling & Testing

Drillers:

Christopher Stratton

Rig Make/Model:

Acker ATV Hallow Stem Auger

Date:

5/22/2008

GEOLOGIC LOG



depth(ft.)	lithology
0'-7'	Fill material, gravelly fine to medium sand, some ash, some brick, traces of glass
7'-17'	Fine to medium sand and silt some gravel
17'-19'	Fine to medium sands and silt.
19'-21"	Silty Clay and Clay

WELL DESIGN

CASING MATERIAL		SCREEN MATERIAL	FILTER MATERIAL
Surface:	Steel flush mount	Type: Schedule 40	Type: #2 Sand Setting:
Monitor:	2" diameter PVC	Slot Size: 10	SEAL MATERIAL Type: Medium Setting: Bentonite Chips

COMMENTS:

LEGEND

-  Cement/Bentonite Grout
-  Bentonite Seal
-  Silica Sandpack

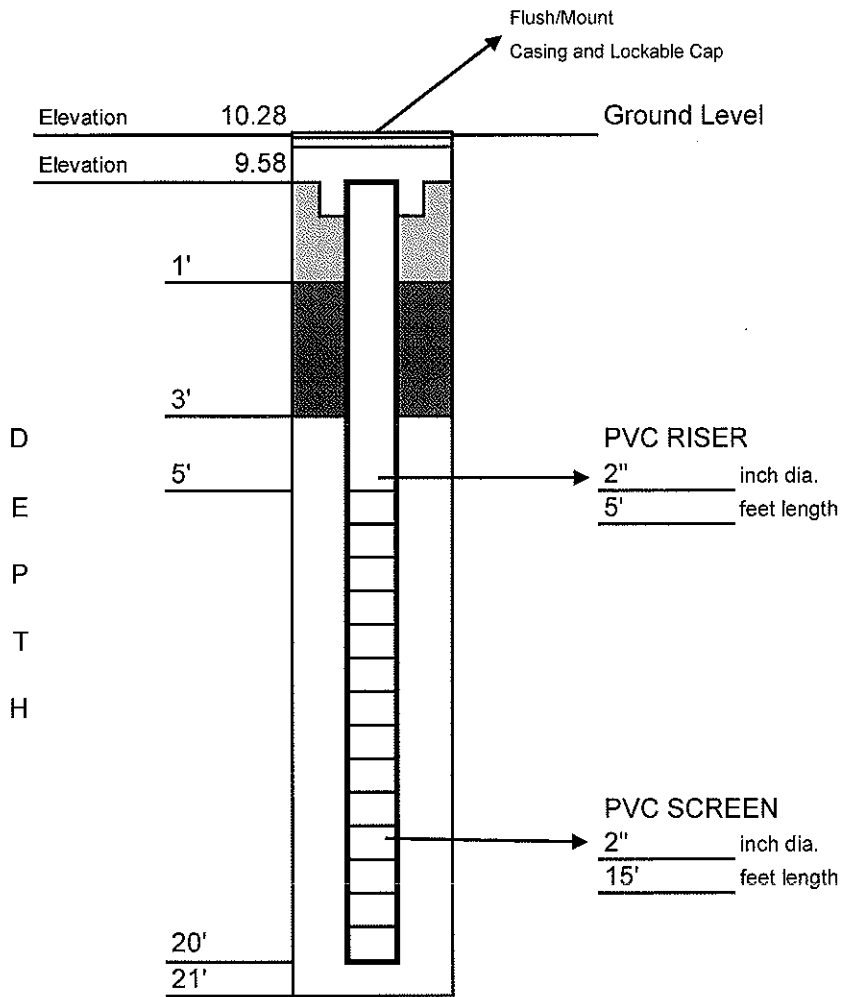

DRILLING SUMMARY

Geologist:
Vladimir Ortiz
Drilling Company:
Aquifer Drilling & Testing

Drillers:
Christopher Stratton
Rig Make/Model:
Acker ATV Hallow Stem Auger
Date:
5/22/2008

GEOLOGIC LOG



depth(ft.)	lithology
0'-5'	Fill material, gravelly fine to medium sand, some gravel
5'-15'	Fine to medium sand and silt some gravel
15'-19'	Fine to medium sand and silt
19'-21'	Silty Clay and Clay

WELL DESIGN

CASING MATERIAL		SCREEN MATERIAL	FILTER MATERIAL
Surface:	Steel flush mount	Type: Schedule 40	Type: #2 Sand Setting:
Monitor:	2" diameter PVC	Slot Size: 10	SEAL MATERIAL Type: Medium Setting: Bentonite Chips

COMMENTS:

LEGEND

-  Cement/Bentonite Grout
-  Bentonite Seal
-  Silica Sandpack

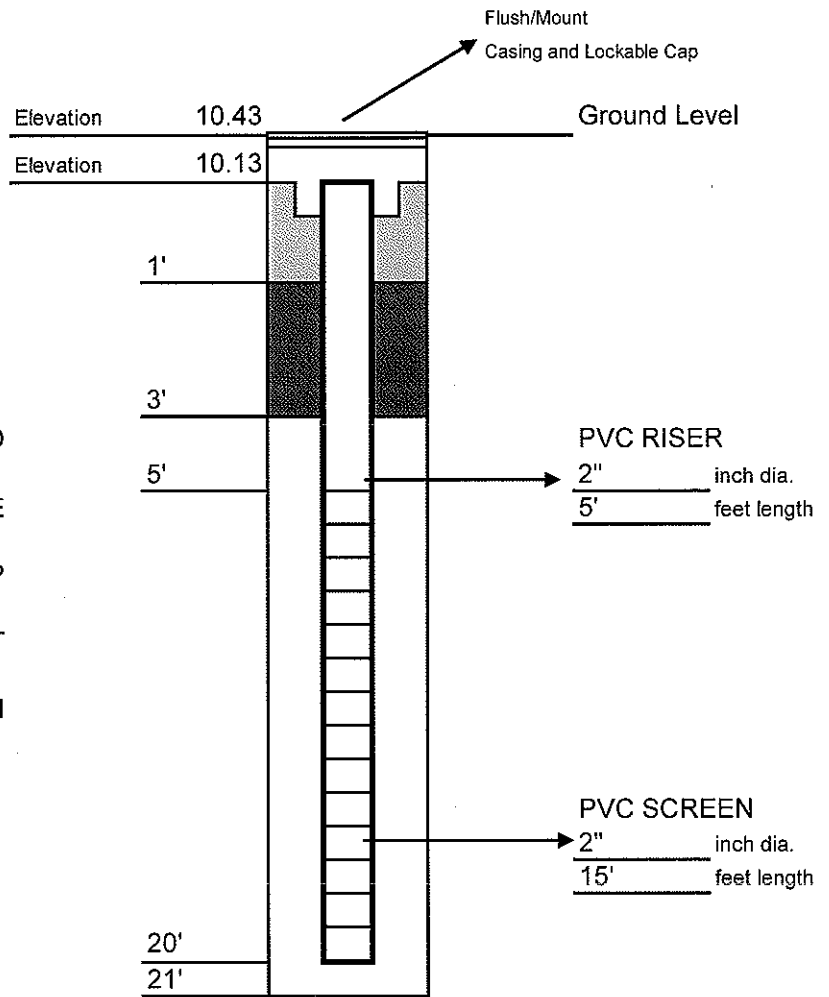

	Project No.:
	Well Number: MW6

MONITORING WELL
CONSTRUCTION DETAILS

APPENDIX D

Monitoring Well Development Logs

Project Title: MENDON

Well ID: SB/MW-1

Site Name: 515 West 18th Street

Date: 2/2/2012

Weather: Sunny

Staff: Manuel Duran

		Well ID	Volume (gal/ft)
A) Total casing and screen length in feet.	<u>19.30</u>	1"	0.04
B) Water level below top of casing in feet.	<u>8.05</u>	2"	0.17
C) Length of standing water [A-B].	<u>11.25</u>	3"	0.38
D) Volume of water/foot of casing (gal.).	<u>0.17</u>	4"	0.66
E) Volume of water in casing (gal.) [CxD].	<u>1.91</u>	5"	1.04
F) Total Volume of water removed (gal.).	<u>20.00</u>	6"	1.50
		8"	2.60

Gallons purged	Parameters							
	5	10	15	20	25	30	35	40
pH	10.01	8.93	8.53	8.40				
Conductivity (S)	1.32	1.51	1.720	1.790				
Turbidity	600	352	555	198				
Dissolved O ₂	0.16	0.17	0.17	0.19				
Temp. (°C)	16.8	16.4	16.4	16.2				
Salinity	0.05	0.07	0.08	0.08				
ORP	48.0	34	20	26				
Appearance	Cloudy	Cloudy	Slightly Cloudy	Clear				

Development Day/Time: 2/2/2012 10:05

Notes: Some petroleum odor

Project Title: MENDON

Well ID: SB/MW-2

Site Name: 515 West 18th Street

Date: 2/2/2012

Weather: Sunny

Staff: Manuel Duran

		Well ID	Volume (gal/ft)
A) Total casing and screen length in feet.	<u>17.60</u>	1"	0.04
B) Water level below top of casing in feet.	<u>8.70</u>	2"	0.17
C) Length of standing water [A-B].	<u>8.90</u>	3"	0.38
D) Volume of water/foot of casing (gal.).	<u>0.17</u>	4"	0.66
E) Volume of water in casing (gal.) [Cx D].	<u>1.51</u>	5"	1.04
F) Total Volume of water removed (gal.).	<u>20.00</u>	6"	1.50
		8"	2.60

Gallons purged	Parameters							
	5	10	15	20	25	30	35	40
pH	9.26	8.96	8.34	8.27				
Conductivity (S)	0.02	4.08	0.010	4.060				
Turbidity	784	875	610	192				
Dissolved O ₂	0.24	0.18	0.27	1.32				
Temp. (°C)	9.9	14.6	10.6	16.3				
Salinity	0.00	0.20	0.00	0.21				
ORP	48.0	34	20	26				
Appearance	Cloudy	Cloudy	Slightly Cloudy	Clear				

Development Day/Time: 2/2/2012 14:05

Notes: Some petroleum odor

Project Title: MENDON

Well ID: SB/MW-3

Site Name: 515 West 18th Street

Date: 2/2/2012

Weather: Sunny

Staff: Manuel Duran

		Well ID	Volume (gal/ft)
A) Total casing and screen length in feet.	<u>19.00</u>	1"	0.04
B) Water level below top of casing in feet.	<u>8.90</u>	2"	0.17
C) Length of standing water [A-B].	<u>10.10</u>	3"	0.38
D) Volume of water/foot of casing (gal.).	<u>0.17</u>	4"	0.66
E) Volume of water in casing (gal.) [Cx D].	<u>1.72</u>	5"	1.04
F) Total Volume of water removed (gal.).	<u>40.00</u>	6"	1.50
		8"	2.60

Gallons purged	Parameters							
	5	10	15	20	25	30	35	40
pH	8.21	8.01	8.14	8.13	8.10	8.04	7.91	7.45
Conductivity (S)	1.73	2.71	1.06	2.21	1.95	1.94	2.79	1.82
Turbidity	785	798	696	685	721	625	591	438
Dissolved O ₂	0.18	0.19	0.20	0.15	0.21	0.24	0.21	0.28
Temp. (°C)	13.9	13.8	12.7	17.6	12.1	9.2	13.4	12.7
Salinity	0.05	0.13	0.04	0.14	0.07	0.08	0.13	0.07
ORP	48.0	34	20	26	28	25	30	32
Appearance	Cloudy	Cloudy	Slightly Cloudy	Slightly Cloudy	Slightly Cloudy	Slightly Cloudy	Slightly Cloudy	Slightly Cloudy

Development Day/Time: 2/2/2012 13:20

Notes: Some petroleum odor

Project Title: MENDON

Well ID: SB/MW-4

Site Name: 515 West 18th Street

Date: 2/2/2012

Weather: Sunny

Staff: Manuel Duran

		Well ID	Volume (gal/ft)
A) Total casing and screen length in feet.	<u>19.50</u>	1"	0.04
B) Water level below top of casing in feet.	<u>8.70</u>	2"	0.17
C) Length of standing water [A-B].	<u>10.80</u>	3"	0.38
D) Volume of water/foot of casing (gal.).	<u>0.17</u>	4"	0.66
E) Volume of water in casing (gal.) [Cx D].	<u>1.84</u>	5"	1.04
F) Total Volume of water removed (gal.).	<u>15.00</u>	6"	1.50
		8"	2.60

Gallons purged	Parameters							
	5	10	15	20	25	30	35	40
pH	8.23	7.91	7.90					
Conductivity (S)	3.96	3.83	3.74					
Turbidity	847	628	182					
Dissolved O ₂	0.14	0.12	0.12					
Temp. (°C)	17.4	18.3	18.3					
Salinity	0.19	0.19	0.18					
ORP	44.0	38	32					
Appearance	Cloudy	Slightly Cloudy	Clear					

Development Day/Time: 2/2/2012 12:40

Notes: Some petroleum odor

Project Title: MENDON

Well ID: SB/MW-5

Site Name: 515 West 18th Street

Date: 2/2/2012

Weather: Sunny

Staff: Manuel Duran

		Well ID	Volume (gal/ft)
A) Total casing and screen length in feet.	<u>19.60</u>	1"	0.04
B) Water level below top of casing in feet.	<u>8.70</u>	2"	0.17
C) Length of standing water [A-B].	<u>10.90</u>	3"	0.38
D) Volume of water/foot of casing (gal.).	<u>0.17</u>	4"	0.66
E) Volume of water in casing (gal.) [CxD].	<u>1.85</u>	5"	1.04
F) Total Volume of water removed (gal.).	<u>20.00</u>	6"	1.50
		8"	2.60

Gallons purged	Parameters							
	5	10	15	20	25	30	35	40
pH	8.04	8.03	8.11	8.11				
Conductivity (S)	2.06	2.06	2.13	2.07				
Turbidity	785	350	350	201				
Dissolved O ₂	0.14	0.14	0.18	0.14				
Temp. (°C)	18.7	18.6	18.5	18.5				
Salinity	0.09	0.09	0.10	0.09				
ORP	44.0	38	32	28				
Appearance	Cloudy	Slightly Cloudy	Slightly Cloudy	Clear				

Development Day/Time: 2/2/2012 11:14

Notes: Some petroleum odor

Project Title: MENDON

Well ID: SB/MW-6

Site Name: 515 West 18th Street

Date: 2/2/2012

Weather: Sunny

Staff: Manuel Duran

		Well ID	Volume (gal/ft)
A) Total casing and screen length in feet.	<u>18.20</u>	1"	0.04
B) Water level below top of casing in feet.	<u>9.30</u>	2"	0.17
C) Length of standing water [A-B].	<u>8.90</u>	3"	0.38
D) Volume of water/foot of casing (gal.).	<u>0.17</u>	4"	0.66
E) Volume of water in casing (gal.) [CxD].	<u>1.51</u>	5"	1.04
F) Total Volume of water removed (gal.).	<u>35.00</u>	6"	1.50
		8"	2.60

Gallons purged	Parameters							
	5	10	15	20	25	30	35	40
pH	8.25	8.43	8.11	7.80	8.22	8.26	8.21	
Conductivity (S)	1.27	1.43	0.01	1.29	1.11	2.56	2.64	
Turbidity	732	615	357	876	652	575	216	
Dissolved O₂	0.22	0.2	0.14	0.17	0.17	0.14	0.18	
Temp. (°C)	11.4	12.8	15.4	13.8	15.3	18.1	12.4	
Salinity	0.05	0.06	0.06	0.06	0.05	0.12	0.14	
ORP	44.0	38	32	28	28	26	26	
Appearance	Cloudy	Cloudy	Slightly Cloudy	Cloudy	Slightly Cloudy	Slightly Cloudy	Clear	

Development Day/Time: 2/2/2012 10:37

Notes: Some petroleum odor

APPENDIX E

Monitoring Well Sampling Logs

Project Title: MENDON

Well ID: SB/MW-1

Site Name: 515 West 18th Street

Date: 2/6/2012

Weather: Sunny

Staff: Manuel Duran

		Well ID	Volume (gal/ft)
A) Total casing and screen length in feet.	<u>19.90</u>	1"	0.04
B) Water level below top of casing in feet.	<u>8.15</u>	2"	0.17
C) Length of standing water [A-B].	<u>11.75</u>	3"	0.38
D) Volume of water/foot of casing (gal.).	<u>0.17</u>	4"	0.66
E) Volume of water in casing (gal.) [CxD].	<u>2.00</u>	5"	1.04
F) Total Volume of water removed (gal.).	<u>5.99</u>	6"	1.50
		8"	2.60

Parameters	Parameters						
	1	3	5				
Gallons purged							
pH	8.38	8.54	8.61				
Conductivity (S)	1.82	1.71	2.460				
Turbidity	999	999	999				
Dissolved O ₂	0.13	0.14	0.13				
Temp. (°C)	17.1	17.3	17.9				
Salinity	0.08	0.08	0.11				
ORP	46.0	40	30				
Appearance	Cloudy	Cloudy	Cloudy				

Sample ID: SB/MW 1

Sample Day/Time: 2/6/2012 - 11:05

Sample Preservation: (2) 40 ml with HCL (1) L amber

Sample Analysis: Full list VOC/SVOC

Notes: _____

Project Title: MENDON

Well ID: SB/MW-2

Site Name: 515 West 18th Street

Date: 2/6/2012

Weather: Sunny

Staff: Manuel Duran

		Well ID	Volume (gal/ft)
A) Total casing and screen length in feet.	<u>19.42</u>	1"	0.04
B) Water level below top of casing in feet.	<u>8.86</u>	2"	0.17
C) Length of standing water [A-B].	<u>10.56</u>	3"	0.38
D) Volume of water/foot of casing (gal.).	<u>0.17</u>	4"	0.66
E) Volume of water in casing (gal.) [Cx D].	<u>1.80</u>	5"	1.04
F) Total Volume of water removed (gal.).	<u>5.39</u>	6"	1.50
		8"	2.60

Gallons purged	Parameters							
	1	3	5					
pH	8.53	8.39	8.37					
Conductivity (S)	4.29	4.02	4.340					
Turbidity	999	999	826					
Dissolved O ₂	0.15	0.16	0.15					
Temp. (°C)	17.4	17.1	17.8					
Salinity	0.22	0.20	0.22					
ORP	42.0	48	40					
Appearance	Cloudy	Cloudy	Cloudy					

Sample ID: SB/MW 2

Sample Day/Time: 2/6/2012 - 1:35

Sample Preservation: (2) 40 ml with HCL (1) L amber

Sample Analysis: Full list VOC/SVOC

Notes: _____

Project Title: MENDON

Well ID: SB/MW-3

Site Name: 515 West 18th Street

Date: 2/6/2012

Weather: Sunny

Staff: Manuel Duran

		Well ID	Volume (gal/ft)
A) Total casing and screen length in feet.	<u>18.92</u>	1"	0.04
B) Water level below top of casing in feet.	<u>9.00</u>	2"	0.17
C) Length of standing water [A-B].	<u>9.92</u>	3"	0.38
D) Volume of water/foot of casing (gal.).	<u>0.17</u>	4"	0.66
E) Volume of water in casing (gal.) [Cx D].	<u>1.69</u>	5"	1.04
F) Total Volume of water removed (gal.).	<u>5.06</u>	6"	1.50
		8"	2.60

Gallons purged	Parameters							
	1	3	5					
pH	8.8	8.6	8.60					
Conductivity (S)	3	3.03	3.00					
Turbidity	999	999	999					
Dissolved O ₂	0.13	0.17	0.18					
Temp. (°C)	18.5	18.6	18.7					
Salinity	0.14	0.15	0.14					
ORP	38.0	34	26					
Appearance	Cloudy	Cloudy	Slightly Cloudy					

Sample ID: SB/MW 3

Sample Day/Time: 2/6/2012 - 12:50

Sample Preservation: (2) 40 ml with HCL (1) L amber

Sample Analysis: Full list VOC/SVOC

Notes: _____

Project Title: MENDON

Well ID: SB/MW-4

Site Name: 515 West 18th Street

Date: 2/6/2012

Weather: Sunny

Staff: Manuel Duran

		Well ID	Volume (gal/ft)
A) Total casing and screen length in feet.	<u>19.56</u>	1"	0.04
B) Water level below top of casing in feet.	<u>8.75</u>	2"	0.17
C) Length of standing water [A-B].	<u>10.81</u>	3"	0.38
D) Volume of water/foot of casing (gal.).	<u>0.17</u>	4"	0.66
E) Volume of water in casing (gal.) [CxD].	<u>1.84</u>	5"	1.04
F) Total Volume of water removed (gal.).	<u>5.51</u>	6"	1.50
		8"	2.60

Parameters	Parameters						
	1	3	5				
Gallons purged							
pH	8.85	8.56	8.51				
Conductivity (S)	3.37	3.69	3.72				
Turbidity	999	999	773				
Dissolved O ₂	0.14	0.17	0.16				
Temp. (°C)	18.6	18.7	18.7				
Salinity	0.16	0.18	0.18				
ORP	39.0	42	36				
Appearance	Cloudy	Cloudy	Slightly Cloudy				

Sample ID: SB/MW 4

Sample Day/Time: 2/6/2012 - 12:35afternoon

Sample Preservation: (2) 40 ml with HCL (1) L amber

Sample Analysis: Full list VOC/SVOC

Notes: _____

Project Title: MENDON

Well ID: SB/MW-5

Site Name: 515 West 18th Street

Date: 2/6/2012

Weather: Sunny

Staff: Manuel Duran

		Well ID	Volume (gal/ft)
A) Total casing and screen length in feet.	<u>19.53</u>	1"	0.04
B) Water level below top of casing in feet.	<u>8.76</u>	2"	0.17
C) Length of standing water [A-B].	<u>10.77</u>	3"	0.38
D) Volume of water/foot of casing (gal.).	<u>0.17</u>	4"	0.66
E) Volume of water in casing (gal.) [CxD].	<u>1.83</u>	5"	1.04
F) Total Volume of water removed (gal.).	<u>5.49</u>	6"	1.50
		8"	2.60

Parameters	Parameters							
	1	3	5					
Gallons purged								
pH	9.5	8.93	8.68					
Conductivity (S)	1.95	2	2.05					
Turbidity	999	999	999					
Dissolved O ₂	0.10	0.17	0.18					
Temp. (°C)	19.1	19	19.0					
Salinity	0.09	0.09	0.09					
ORP	42.0	40	42					
Appearance	Cloudy	Cloudy	Cloudy					

Sample ID: SB/MW 5

Sample Day/Time: 2/6/2012 - 12:10

Sample Preservation: (2) 40 ml with HCL (1) L amber

Sample Analysis: Full list VOC/SVOC

Notes: _____

Project Title: MENDON

Well ID: SB/MW-6

Site Name: 515 West 18th Street

Date: 2/6/2012

Weather: Sunny

Staff: Manuel Duran

		Well ID	Volume (gal/ft)
A) Total casing and screen length in feet.	<u>19.00</u>	1"	0.04
B) Water level below top of casing in feet.	<u>9.30</u>	2"	0.17
C) Length of standing water [A-B].	<u>9.70</u>	3"	0.38
D) Volume of water/foot of casing (gal.).	<u>0.17</u>	4"	0.66
E) Volume of water in casing (gal.) [CxD].	<u>1.65</u>	5"	1.04
F) Total Volume of water removed (gal.).	<u>4.95</u>	6"	1.50
		8"	2.60

Gallons purged	Parameters							
	1	3	5					
pH	9.34	8.75	8.64					
Conductivity (S)	2.57	2.66	2.63					
Turbidity	999	999	999					
Dissolved O ₂	0.13	0.13	0.14					
Temp. (°C)	18.8	19.1	19.2					
Salinity	0.12	0.13	0.12					
ORP	50.0	46	40					
Appearance	Cloudy	Cloudy	Cloudy					

Sample ID: SB/MW 6

Sample Day/Time: 2/6/2012 - 11:25

Sample Preservation: (2) 40 ml with HCL (1) L amber

Sample Analysis: Full list VOC/SVOC

Notes: _____

Project Title: MENDON

Well ID: SB/MW-219

Site Name: 515 West 18th Street

Date: 2/6/2012

Weather: Sunny

Staff: Manuel Duran

		Well ID	Volume (gal/ft)
A) Total casing and screen length in feet.	<u>14.23</u>	1"	0.04
B) Water level below top of casing in feet.	<u>8.40</u>	2"	0.17
C) Length of standing water [A-B].	<u>5.83</u>	3"	0.38
D) Volume of water/foot of casing (gal.).	<u>0.17</u>	4"	0.66
E) Volume of water in casing (gal.) [Cx D].	<u>0.99</u>	5"	1.04
F) Total Volume of water removed (gal.).	<u>2.97</u>	6"	1.50
		8"	2.60

Gallons purged	Parameters							
	1	3	5					
pH	9.4	8.75	8.72					
Conductivity (S)	3.32	4.06	4.14					
Turbidity	362	591	999					
Dissolved O ₂	0.18	0.23	0.18					
Temp. (°C)	15.4	16.9	16.9					
Salinity	0.16	0.20	0.21					
ORP	36.0	30	26					
Appearance	Slightly Cloudy	Slightly Cloudy	Cloudy					

Sample ID: SB/MW 219

Sample Day/Time: 2/6/2012 - 1:15

Sample Preservation: (2) 40 ml with HCL (1) L amber

Sample Analysis: Full list VOC/SVOC

Notes: _____

Project Title: MENDON

Well ID: SB/MW-7A

Site Name: 515 West 18th Street

Date: 2/6/2012

Weather: Sunny

Staff: Manuel Duran

		Well ID	Volume (gal/ft)
A) Total casing and screen length in feet.	<u>15.38</u>	1"	0.04
B) Water level below top of casing in feet.	<u>8.16</u>	2"	0.17
C) Length of standing water [A-B].	<u>7.22</u>	3"	0.38
D) Volume of water/foot of casing (gal.).	<u>0.17</u>	4"	0.66
E) Volume of water in casing (gal.) [CxD].	<u>1.23</u>	5"	1.04
F) Total Volume of water removed (gal.).	<u>3.68</u>	6"	1.50
		8"	2.60

Gallons purged	Parameters							
	1	3	5					
pH	8.77	8.79	8.99					
Conductivity (S)	3.64	3.97	4.13					
Turbidity	394	440	190					
Dissolved O ₂	0.20	0.2	0.19					
Temp. (°C)	14.3	14.9	15.2					
Salinity	0.18	0.20	0.21					
ORP	42.0	36	30					
Appearance	Slightly Cloudy	Slightly Cloudy	Clear					

Sample ID: SB/MW 7A

Sample Day/Time: 2/6/2012 - 2:20

Sample Preservation: (2) 40 ml with HCL (1) L amber

Sample Analysis: Full list VOC/SVOC

Notes: _____

Project Title: MENDON

Well ID: SB/MW-224

Site Name: 515 West 18th Street

Date: 2/6/2012

Weather: Sunny

Staff: Manuel Duran

		Well ID	Volume (gal/ft)
A) Total casing and screen length in feet.	<u>14.28</u>	1"	0.04
B) Water level below top of casing in feet.	<u>9.53</u>	2"	0.17
C) Length of standing water [A-B].	<u>4.75</u>	3"	0.38
D) Volume of water/foot of casing (gal.).	<u>0.17</u>	4"	0.66
E) Volume of water in casing (gal.) [Cx D].	<u>0.81</u>	5"	1.04
F) Total Volume of water removed (gal.).	<u>2.42</u>	6"	1.50
		8"	2.60

Gallons purged	Parameters							
	1	3	5					
pH	9.2	8.6	8.58					
Conductivity (S)	1.4	1.13	1.06					
Turbidity	999	967	361					
Dissolved O ₂	0.18	0.17	0.19					
Temp. (°C)	14.5	15.2	15.4					
Salinity	0.06	0.05	0.04					
ORP	48.0	44	24					
Appearance	Cloudy	Cloudy	Slightly Cloudy					

Sample ID: SB/MW 224

Sample Day/Time: 2/6/2012 - 1:55

Sample Preservation: (2) 40 ml with HCL (1) L amber

Sample Analysis: Full list VOC/SVOC

Notes: Visible Sheen and strong petroleum odor

APPENDIX F

Analytical Laboratory Reports

YORK

ANALYTICAL LABORATORIES, INC.

Technical Report

prepared for:

Core Environmental
2312 Wehrle Drive
Williamsville NY, 14221
Attention: Ron Tramposch

Report Date: 02/14/2012
Client Project ID: 515 West 18th St.
York Project (SDG) No.: 12B0219

CT License No. PH-0723

New Jersey License No. CT-005



New York License No. 10854

PA License No. 68-04440

Report Date: 02/14/2012
Client Project ID: 515 West 18th St.
York Project (SDG) No.: 12B0219

Core Environmental
2312 Wehrle Drive
Williamsville NY, 14221
Attention: Ron Tramposch

Purpose and Results

This report contains the analytical data for the sample(s) identified on the attached chain-of-custody received in our laboratory on February 07, 2012 and listed below. The project was identified as your project: **515 West 18th St.**

The analyses were conducted utilizing appropriate EPA, Standard Methods, and ASTM methods as detailed in the data summary tables.

All samples were received in proper condition meeting the customary acceptance requirements for environmental samples except those indicated under the Notes section of this report.

All analyses met the method and laboratory standard operating procedure requirements except as indicated by any data flags, the meaning of which are explained in the attachment to this report, and case narrative if applicable.

The results of the analyses, which are all reported on dry weight basis (soils) unless otherwise noted, are detailed in the following pages.

Please contact Client Services at 203.325.1371 with any questions regarding this report.

<u>York Sample ID</u>	<u>Client Sample ID</u>	<u>Matrix</u>	<u>Date Collected</u>	<u>Date Received</u>
12B0219-01	515W18-SB/MW1-GW	Water	02/06/2012	02/07/2012
12B0219-02	515W18-SB/MW2-GW	Water	02/06/2012	02/07/2012
12B0219-03	515W18-SB/MW3-GW	Water	02/06/2012	02/07/2012
12B0219-04	515W18-SB/MW4-GW	Water	02/06/2012	02/07/2012
12B0219-05	515W18-SB/MW5-GW	Water	02/06/2012	02/07/2012
12B0219-06	515W18-SB/MW6-GW	Water	02/06/2012	02/07/2012
12B0219-07	515W18-SB/MW219-GW	Water	02/06/2012	02/07/2012
12B0219-08	515W18-SB/MW224-GW	Water	02/06/2012	02/07/2012
12B0219-09	515W18-SB/MW7A-GW	Water	02/06/2012	02/07/2012

General Notes for York Project (SDG) No.: 12B0219

1. The RLs and MDLs (Reporting Limit and Method Detection Limit respectively) reported are adjusted for any dilution necessary due to the levels of target and/or non-target analytes and matrix interference. The RL(REPORTING LIMIT) is based upon the lowest standard utilized for the calibration where applicable.
Samples are retained for a period of thirty days after submittal of report, unless other arrangements are made.
2. York's liability for the above data is limited to the dollar value paid to York for the referenced project.
4. This report shall not be reproduced without the written approval of York Analytical Laboratories, Inc.
5. All samples were received in proper condition for analysis with proper documentation, unless otherwise noted.
6. All analyses conducted met method or Laboratory SOP requirements. See the Qualifiers and/or Narrative sections for further information.
7. It is noted that no analyses reported herein were subcontracted to another laboratory, unless noted in the report.
8. This report reflects results that relate only to the samples submitted on the attached chain-of-custody form(s) received by York.

Approved By: 

Date: 02/14/2012

Robert Q. Bradley
Executive Vice President / Laboratory Director

YORK

YORK

ANALYTICAL LABORATORIES, INC.

Sample Information

Client Sample ID: 515W18-SB/MW1-GW

York Sample ID: 12B0219-01

York Project (SDG) No.
12B0219

Client Project ID
515 West 18th St.

Matrix
Water

Collection Date/Time
February 6, 2012 3:00 pm

Date Received
02/07/2012

Volatile Organics, 8260 List

Log-in Notes:

Sample Notes:

Sample Prepared by Method: EPA 5030B

CAS No.	Parameter	Result	Flag	Units	MDL	RL	Dilution	Reference Method	Date/Time Prepared	Date/Time Analyzed	Analyst
630-20-6	1,1,1,2-Tetrachloroethane	ND		ug/L	5.4	50	10	EPA SW846-8260B	02/09/2012 15:14	02/10/2012 03:16	SS
71-55-6	1,1,1-Trichloroethane	ND		ug/L	9.5	50	10	EPA SW846-8260B	02/09/2012 15:14	02/10/2012 03:16	SS
79-34-5	1,1,2,2-Tetrachloroethane	ND		ug/L	5.7	50	10	EPA SW846-8260B	02/09/2012 15:14	02/10/2012 03:16	SS
76-13-1	1,1,2-Trichloro-1,2,2-trifluoroethane (Freon 113)	ND		ug/L	6.0	50	10	EPA SW846-8260B	02/09/2012 15:14	02/10/2012 03:16	SS
79-00-5	1,1,2-Trichloroethane	ND		ug/L	6.1	50	10	EPA SW846-8260B	02/09/2012 15:14	02/10/2012 03:16	SS
75-34-3	1,1-Dichloroethane	ND		ug/L	6.9	50	10	EPA SW846-8260B	02/09/2012 15:14	02/10/2012 03:16	SS
75-35-4	1,1-Dichloroethylene	ND		ug/L	13	50	10	EPA SW846-8260B	02/09/2012 15:14	02/10/2012 03:16	SS
563-58-6	1,1-Dichloropropylene	ND		ug/L	4.3	50	10	EPA SW846-8260B	02/09/2012 15:14	02/10/2012 03:16	SS
87-61-6	1,2,3-Trichlorobenzene	ND		ug/L	3.7	100	10	EPA SW846-8260B	02/09/2012 15:14	02/10/2012 03:16	SS
96-18-4	1,2,3-Trichloropropane	ND		ug/L	11	50	10	EPA SW846-8260B	02/09/2012 15:14	02/10/2012 03:16	SS
120-82-1	1,2,4-Trichlorobenzene	ND		ug/L	4.8	100	10	EPA SW846-8260B	02/09/2012 15:14	02/10/2012 03:16	SS
63-6	1,2,4-Trimethylbenzene	ND		ug/L	5.3	50	10	EPA SW846-8260B	02/09/2012 15:14	02/10/2012 03:16	SS
12-8	1,2-Dibromo-3-chloropropane	ND		ug/L	13	100	10	EPA SW846-8260B	02/09/2012 15:14	02/10/2012 03:16	SS
106-93-4	1,2-Dibromoethane	ND		ug/L	6.8	50	10	EPA SW846-8260B	02/09/2012 15:14	02/10/2012 03:16	SS
95-50-1	1,2-Dichlorobenzene	ND		ug/L	5.9	50	10	EPA SW846-8260B	02/09/2012 15:14	02/10/2012 03:16	SS
107-06-2	1,2-Dichloroethane	ND		ug/L	6.5	50	10	EPA SW846-8260B	02/09/2012 15:14	02/10/2012 03:16	SS
78-87-5	1,2-Dichloropropane	ND		ug/L	2.2	50	10	EPA SW846-8260B	02/09/2012 15:14	02/10/2012 03:16	SS
108-67-8	1,3,5-Trimethylbenzene	ND		ug/L	3.7	50	10	EPA SW846-8260B	02/09/2012 15:14	02/10/2012 03:16	SS
541-73-1	1,3-Dichlorobenzene	ND		ug/L	4.7	50	10	EPA SW846-8260B	02/09/2012 15:14	02/10/2012 03:16	SS
142-28-9	1,3-Dichloropropane	ND		ug/L	6.9	50	10	EPA SW846-8260B	02/09/2012 15:14	02/10/2012 03:16	SS
106-46-7	1,4-Dichlorobenzene	ND		ug/L	6.8	50	10	EPA SW846-8260B	02/09/2012 15:14	02/10/2012 03:16	SS
594-20-7	2,2-Dichloropropane	ND		ug/L	9.6	50	10	EPA SW846-8260B	02/09/2012 15:14	02/10/2012 03:16	SS
78-93-3	2-Butanone	ND		ug/L	26	100	10	EPA SW846-8260B	02/09/2012 15:14	02/10/2012 03:16	SS
95-49-8	2-Chlorotoluene	ND		ug/L	4.9	50	10	EPA SW846-8260B	02/09/2012 15:14	02/10/2012 03:16	SS
106-43-4	4-Chlorotoluene	ND		ug/L	4.9	50	10	EPA SW846-8260B	02/09/2012 15:14	02/10/2012 03:16	SS
67-64-1	Acetone	ND		ug/L	31	100	10	EPA SW846-8260B	02/09/2012 15:14	02/10/2012 03:16	SS
71-43-2	Benzene	50		ug/L	4.8	50	10	EPA SW846-8260B	02/09/2012 15:14	02/10/2012 03:16	SS
108-86-1	Bromobenzene	ND		ug/L	6.1	50	10	EPA SW846-8260B	02/09/2012 15:14	02/10/2012 03:16	SS
74-97-5	Bromochloromethane	ND		ug/L	13	50	10	EPA SW846-8260B	02/09/2012 15:14	02/10/2012 03:16	SS
75-27-4	Bromodichloromethane	ND		ug/L	6.2	50	10	EPA SW846-8260B	02/09/2012 15:14	02/10/2012 03:16	SS
75-25-2	Bromoform	ND		ug/L	5.8	50	10	EPA SW846-8260B	02/09/2012 15:14	02/10/2012 03:16	SS
109	Bromomethane	ND		ug/L	12	50	10	EPA SW846-8260B	02/09/2012 15:14	02/10/2012 03:16	SS
56-23-5	Carbon tetrachloride	ND		ug/L	10	50	10	EPA SW846-8260B	02/09/2012 15:14	02/10/2012 03:16	SS
108-90-7	Chlorobenzene	ND		ug/L	3.5	50	10	EPA SW846-8260B	02/09/2012 15:14	02/10/2012 03:16	SS

YORK

ANALYTICAL LABORATORIES, INC.

Sample Information

Client Sample ID: 515W18-SB/MW1-GW

York Sample ID: 12B0219-01

York Project (SDG) No.
12B0219

Client Project ID
515 West 18th St.

Matrix
Water

Collection Date/Time
February 6, 2012 3:00 pm

Date Received
02/07/2012

Volatiles Organics, 8260 List

Sample Prepared by Method: EPA 5030B

Log-in Notes:

Sample Notes:

CAS No.	Parameter	Result	Flag	Units	MDL	RL	Dilution	Reference Method	Date/Time Prepared	Date/Time Analyzed	Analyst
75-00-3	Chloroethane	ND		ug/L	7.6	50	10	EPA SW846-8260B	02/09/2012 15:14	02/10/2012 03:16	SS
67-66-3	Chloroform	ND		ug/L	3.6	50	10	EPA SW846-8260B	02/09/2012 15:14	02/10/2012 03:16	SS
74-87-3	Chloromethane	ND		ug/L	8.9	50	10	EPA SW846-8260B	02/09/2012 15:14	02/10/2012 03:16	SS
156-59-2	cis-1,2-Dichloroethylene	ND		ug/L	9.6	50	10	EPA SW846-8260B	02/09/2012 15:14	02/10/2012 03:16	SS
10061-01-5	cis-1,3-Dichloropropylene	ND		ug/L	3.5	50	10	EPA SW846-8260B	02/09/2012 15:14	02/10/2012 03:16	SS
124-48-1	Dibromochloromethane	ND		ug/L	6.7	50	10	EPA SW846-8260B	02/09/2012 15:14	02/10/2012 03:16	SS
74-95-3	Dibromomethane	ND		ug/L	13	50	10	EPA SW846-8260B	02/09/2012 15:14	02/10/2012 03:16	SS
75-71-8	Dichlorodifluoromethane	ND		ug/L	8.3	50	10	EPA SW846-8260B	02/09/2012 15:14	02/10/2012 03:16	SS
100-41-4	Ethyl Benzene	ND		ug/L	3.5	50	10	EPA SW846-8260B	02/09/2012 15:14	02/10/2012 03:16	SS
87-68-3	Hexachlorobutadiene	ND		ug/L	4.3	50	10	EPA SW846-8260B	02/09/2012 15:14	02/10/2012 03:16	SS
98-82-8	Isopropylbenzene	24	J	ug/L	3.9	50	10	EPA SW846-8260B	02/09/2012 15:14	02/10/2012 03:16	SS
1634-04-4	Methyl tert-butyl ether (MTBE)	ND		ug/L	3.8	50	10	EPA SW846-8260B	02/09/2012 15:14	02/10/2012 03:16	SS
75-28-5	Methylene chloride	44	I, B	ug/L	11	100	10	EPA SW846-8260B	02/09/2012 15:14	02/10/2012 03:16	SS
91-20-3	Naphthalene	ND		ug/L	5.0	100	10	EPA SW846-8260B	02/09/2012 15:14	02/10/2012 03:16	SS
104-51-8	n-Butylbenzene	ND		ug/L	3.2	50	10	EPA SW846-8260B	02/09/2012 15:14	02/10/2012 03:16	SS
103-65-1	n-Propylbenzene	22	J	ug/L	5.8	50	10	EPA SW846-8260B	02/09/2012 15:14	02/10/2012 03:16	SS
95-47-6	o-Xylene	ND		ug/L	5.0	50	10	EPA SW846-8260B	02/09/2012 15:14	02/10/2012 03:16	SS
1330-20-7P/M	p- & m- Xylenes	ND		ug/L	5.5	100	10	EPA SW846-8260B	02/09/2012 15:14	02/10/2012 03:16	SS
99-87-6	p-Isopropyltoluene	ND		ug/L	2.5	50	10	EPA SW846-8260B	02/09/2012 15:14	02/10/2012 03:16	SS
135-98-8	sec-Butylbenzene	ND		ug/L	5.2	50	10	EPA SW846-8260B	02/09/2012 15:14	02/10/2012 03:16	SS
100-42-5	Styrene	ND		ug/L	4.3	50	10	EPA SW846-8260B	02/09/2012 15:14	02/10/2012 03:16	SS
98-06-6	tert-Butylbenzene	ND		ug/L	4.6	50	10	EPA SW846-8260B	02/09/2012 15:14	02/10/2012 03:16	SS
127-18-4	Tetrachloroethylene	ND		ug/L	5.2	50	10	EPA SW846-8260B	02/09/2012 15:14	02/10/2012 03:16	SS
108-88-3	Toluene	ND		ug/L	2.3	50	10	EPA SW846-8260B	02/09/2012 15:14	02/10/2012 03:16	SS
156-60-5	trans-1,2-Dichloroethylene	ND		ug/L	6.5	50	10	EPA SW846-8260B	02/09/2012 15:14	02/10/2012 03:16	SS
10061-02-6	trans-1,3-Dichloropropylene	ND		ug/L	6.8	50	10	EPA SW846-8260B	02/09/2012 15:14	02/10/2012 03:16	SS
79-01-6	Trichloroethylene	ND		ug/L	5.7	50	10	EPA SW846-8260B	02/09/2012 15:14	02/10/2012 03:16	SS
75-69-4	Trichlorofluoromethane	ND		ug/L	9.1	50	10	EPA SW846-8260B	02/09/2012 15:14	02/10/2012 03:16	SS
75-01-4	Vinyl Chloride	ND		ug/L	9.7	50	10	EPA SW846-8260B	02/09/2012 15:14	02/10/2012 03:16	SS
1330-20-7	Xylenes, Total	ND		ug/L	10	150	10	EPA SW846-8260B	02/09/2012 15:14	02/10/2012 03:16	SS

YORK

ANALYTICAL LABORATORIES, INC.

Sample Information

Client Sample ID: 515W18-SB/MW1-GW

York Sample ID: 12B0219-01

York Project (SDG) No.
12B0219

Client Project ID
515 West 18th St.

Matrix
Water

Collection Date/Time
February 6, 2012 3:00 pm

Date Received
02/07/2012

Semi-Volatiles, 8270 Target List

Log-in Notes:

Sample Notes:

Sample Prepared by Method: EPA 3510C

CAS No.	Parameter	Result	Flag	Units	MDL	RL	Dilution	Reference Method	Date/Time Prepared	Date/Time Analyzed	Analyst
120-82-1	1,2,4-Trichlorobenzene	ND		ug/L	1.31	5.00	1	EPA SW-846 8270C	02/08/2012 07:46	02/08/2012 21:43	TD
95-50-1	1,2-Dichlorobenzene	ND		ug/L	1.64	5.00	1	EPA SW-846 8270C	02/08/2012 07:46	02/08/2012 21:43	TD
541-73-1	1,3-Dichlorobenzene	ND		ug/L	2.75	5.00	1	EPA SW-846 8270C	02/08/2012 07:46	02/08/2012 21:43	TD
106-46-7	1,4-Dichlorobenzene	ND		ug/L	3.23	5.00	1	EPA SW-846 8270C	02/08/2012 07:46	02/08/2012 21:43	TD
95-95-4	2,4,5-Trichlorophenol	ND		ug/L	3.61	5.00	1	EPA SW-846 8270C	02/08/2012 07:46	02/08/2012 21:43	TD
88-06-2	2,4,6-Trichlorophenol	ND		ug/L	3.27	5.00	1	EPA SW-846 8270C	02/08/2012 07:46	02/08/2012 21:43	TD
120-83-2	2,4-Dichlorophenol	ND		ug/L	3.09	5.00	1	EPA SW-846 8270C	02/08/2012 07:46	02/08/2012 21:43	TD
105-67-9	2,4-Dimethylphenol	ND		ug/L	3.68	5.00	1	EPA SW-846 8270C	02/08/2012 07:46	02/08/2012 21:43	TD
51-28-5	2,4-Dinitrophenol	ND		ug/L	9.60	10.0	1	EPA SW-846 8270C	02/08/2012 07:46	02/08/2012 21:43	TD
121-14-2	2,4-Dinitrotoluene	ND		ug/L	2.37	5.00	1	EPA SW-846 8270C	02/08/2012 07:46	02/08/2012 21:43	TD
606-20-2	2,6-Dinitrotoluene	ND		ug/L	3.51	5.00	1	EPA SW-846 8270C	02/08/2012 07:46	02/08/2012 21:43	TD
91-58-7	2-Chloronaphthalene	ND		ug/L	3.49	5.00	1	EPA SW-846 8270C	02/08/2012 07:46	02/08/2012 21:43	TD
7-8	2-Chlorophenol	ND		ug/L	3.42	5.00	1	EPA SW-846 8270C	02/08/2012 07:46	02/08/2012 21:43	TD
91-57-6	2-Methylnaphthalene	ND		ug/L	3.07	5.00	1	EPA SW-846 8270C	02/08/2012 07:46	02/08/2012 21:43	TD
95-48-7	2-Methylphenol	ND		ug/L	0.857	5.00	1	EPA SW-846 8270C	02/08/2012 07:46	02/08/2012 21:43	TD
88-74-4	2-Nitroaniline	ND		ug/L	3.01	5.00	1	EPA SW-846 8270C	02/08/2012 07:46	02/08/2012 21:43	TD
88-75-5	2-Nitrophenol	ND		ug/L	3.10	5.00	1	EPA SW-846 8270C	02/08/2012 07:46	02/08/2012 21:43	TD
100-01-6	3- & 4-Methylphenols	ND		ug/L	3.72	5.00	1	EPA SW-846 8270C	02/08/2012 07:46	02/08/2012 21:43	TD
91-94-1	3,3'-Dichlorobenzidine	ND		ug/L	3.51	5.00	1	EPA SW-846 8270C	02/08/2012 07:46	02/08/2012 21:43	TD
99-09-2	3-Nitroaniline	ND		ug/L	1.59	5.00	1	EPA SW-846 8270C	02/08/2012 07:46	02/08/2012 21:43	TD
534-52-1	4,6-Dinitro-2-methylphenol	ND		ug/L	6.70	10.0	1	EPA SW-846 8270C	02/08/2012 07:46	02/08/2012 21:43	TD
101-55-3	4-Bromophenyl phenyl ether	ND		ug/L	3.45	5.00	1	EPA SW-846 8270C	02/08/2012 07:46	02/08/2012 21:43	TD
59-50-7	4-Chloro-3-methylphenol	ND		ug/L	3.63	5.00	1	EPA SW-846 8270C	02/08/2012 07:46	02/08/2012 21:43	TD
106-47-8	4-Chloroaniline	ND		ug/L	3.74	5.00	1	EPA SW-846 8270C	02/08/2012 07:46	02/08/2012 21:43	TD
7005-72-3	4-Chlorophenyl phenyl ether	ND		ug/L	3.12	5.00	1	EPA SW-846 8270C	02/08/2012 07:46	02/08/2012 21:43	TD
100-02-7	4-Nitroaniline	ND		ug/L	3.77	5.00	1	EPA SW-846 8270C	02/08/2012 07:46	02/08/2012 21:43	TD
56-57-5	4-Nitrophenol	ND		ug/L	3.94	5.00	1	EPA SW-846 8270C	02/08/2012 07:46	02/08/2012 21:43	TD
83-32-9	Acenaphthene	ND		ug/L	3.24	5.00	1	EPA SW-846 8270C	02/08/2012 07:46	02/08/2012 21:43	TD
208-96-8	Acenaphthylene	ND		ug/L	4.27	5.00	1	EPA SW-846 8270C	02/08/2012 07:46	02/08/2012 21:43	TD
62-53-3	Aniline	ND		ug/L	1.97	5.00	1	EPA SW-846 8270C	02/08/2012 07:46	02/08/2012 21:43	TD
120-12-7	Anthracene	ND		ug/L	3.66	5.00	1	EPA SW-846 8270C	02/08/2012 07:46	02/08/2012 21:43	TD
5-3	Benzo(a)anthracene	ND		ug/L	4.07	5.00	1	EPA SW-846 8270C	02/08/2012 07:46	02/08/2012 21:43	TD
50-32-8	Benzo(a)pyrene	ND		ug/L	4.85	5.00	1	EPA SW-846 8270C	02/08/2012 07:46	02/08/2012 21:43	TD
205-99-2	Benzo(b)fluoranthene	ND		ug/L	4.12	5.00	1	EPA SW-846 8270C	02/08/2012 07:46	02/08/2012 21:43	TD
191-24-2	Benzo(g,h,i)perylene	ND		ug/L	4.15	5.00	1	EPA SW-846 8270C	02/08/2012 07:46	02/08/2012 21:43	TD

YORK

ANALYTICAL LABORATORIES, INC.

Sample Information

Client Sample ID: 515W18-SB/MW1-GW

York Sample ID: 12B0219-01

York Project (SDG) No.
12B0219

Client Project ID
515 West 18th St.

Matrix
Water

Collection Date/Time
February 6, 2012 3:00 pm

Date Received
02/07/2012

Semi-Volatiles, 8270 Target List

Log-in Notes:

Sample Notes:

Sample Prepared by Method: EPA 3510C

CAS No.	Parameter	Result	Flag	Units	MDL	RL	Dilution	Reference Method	Date/Time Prepared	Date/Time Analyzed	Analyst
207-08-9	Benzo(k)fluoranthene	ND		ug/L	3.46	5.00	1	EPA SW-846 8270C	02/08/2012 07:46	02/08/2012 21:43	TD
100-51-6	Benzyl alcohol	ND		ug/L	4.00	5.00	1	EPA SW-846 8270C	02/08/2012 07:46	02/08/2012 21:43	TD
85-68-7	Benzyl butyl phthalate	ND		ug/L	2.30	5.00	1	EPA SW-846 8270C	02/08/2012 07:46	02/08/2012 21:43	TD
111-91-1	Bis(2-chloroethoxy)methane	ND		ug/L	4.85	5.00	1	EPA SW-846 8270C	02/08/2012 07:46	02/08/2012 21:43	TD
111-44-4	Bis(2-chloroethyl)ether	ND		ug/L	4.12	5.00	1	EPA SW-846 8270C	02/08/2012 07:46	02/08/2012 21:43	TD
108-60-1	Bis(2-chloroisopropyl)ether	ND		ug/L	4.15	5.00	1	EPA SW-846 8270C	02/08/2012 07:46	02/08/2012 21:43	TD
117-81-7	Bis(2-ethylhexyl)phthalate	16.0		ug/L	2.57	5.00	1	EPA SW-846 8270C	02/08/2012 07:46	02/08/2012 21:43	TD
218-01-9	Chrysene	ND		ug/L	4.15	5.00	1	EPA SW-846 8270C	02/08/2012 07:46	02/08/2012 21:43	TD
53-70-3	Dibenzo(a,h)anthracene	ND		ug/L	3.10	5.00	1	EPA SW-846 8270C	02/08/2012 07:46	02/08/2012 21:43	TD
132-64-9	Dibenzofuran	ND		ug/L	2.90	5.00	1	EPA SW-846 8270C	02/08/2012 07:46	02/08/2012 21:43	TD
84-66-2	Diethyl phthalate	ND		ug/L	2.20	5.00	1	EPA SW-846 8270C	02/08/2012 07:46	02/08/2012 21:43	TD
131-11-3	Dimethyl phthalate	ND		ug/L	4.85	5.00	1	EPA SW-846 8270C	02/08/2012 07:46	02/08/2012 21:43	TD
14-2	Di-n-butyl phthalate	ND		ug/L	4.12	5.00	1	EPA SW-846 8270C	02/08/2012 07:46	02/08/2012 21:43	TD
117-84-0	Di-n-octyl phthalate	ND		ug/L	4.15	5.00	1	EPA SW-846 8270C	02/08/2012 07:46	02/08/2012 21:43	TD
206-44-0	Fluoranthene	ND		ug/L	1.59	5.00	1	EPA SW-846 8270C	02/08/2012 07:46	02/08/2012 21:43	TD
86-73-7	Fluorene	ND		ug/L	3.22	5.00	1	EPA SW-846 8270C	02/08/2012 07:46	02/08/2012 21:43	TD
118-74-1	Hexachlorobenzene	ND		ug/L	2.96	5.00	1	EPA SW-846 8270C	02/08/2012 07:46	02/08/2012 21:43	TD
87-68-3	Hexachlorobutadiene	ND		ug/L	3.31	5.00	1	EPA SW-846 8270C	02/08/2012 07:46	02/08/2012 21:43	TD
77-47-4	Hexachlorocyclopentadiene	ND		ug/L	3.45	5.00	1	EPA SW-846 8270C	02/08/2012 07:46	02/08/2012 21:43	TD
67-72-1	Hexachloroethane	ND		ug/L	3.63	5.00	1	EPA SW-846 8270C	02/08/2012 07:46	02/08/2012 21:43	TD
193-39-5	Indeno(1,2,3-cd)pyrene	ND		ug/L	2.75	5.00	1	EPA SW-846 8270C	02/08/2012 07:46	02/08/2012 21:43	TD
78-59-1	Isophorone	ND		ug/L	3.23	5.00	1	EPA SW-846 8270C	02/08/2012 07:46	02/08/2012 21:43	TD
91-20-3	Naphthalene	ND		ug/L	3.86	5.00	1	EPA SW-846 8270C	02/08/2012 07:46	02/08/2012 21:43	TD
98-95-3	Nitrobenzene	ND		ug/L	1.97	5.00	1	EPA SW-846 8270C	02/08/2012 07:46	02/08/2012 21:43	TD
62-75-9	N-Nitrosodimethylamine	ND		ug/L	3.10	5.00	1	EPA SW-846 8270C	02/08/2012 07:46	02/08/2012 21:43	TD
621-64-7	N-nitroso-di-n-propylamine	ND		ug/L	2.57	5.00	1	EPA SW-846 8270C	02/08/2012 07:46	02/08/2012 21:43	TD
86-30-6	N-Nitrosodiphenylamine	ND		ug/L	3.62	5.00	1	EPA SW-846 8270C	02/08/2012 07:46	02/08/2012 21:43	TD
87-86-5	Pentachlorophenol	ND		ug/L	3.76	5.00	1	EPA SW-846 8270C	02/08/2012 07:46	02/08/2012 21:43	TD
85-01-8	Phenanthrene	ND		ug/L	3.61	5.00	1	EPA SW-846 8270C	02/08/2012 07:46	02/08/2012 21:43	TD
108-95-2	Phenol	ND		ug/L	3.27	5.00	1	EPA SW-846 8270C	02/08/2012 07:46	02/08/2012 21:43	TD
129-00-0	Pyrene	ND		ug/L	2.37	5.00	1	EPA SW-846 8270C	02/08/2012 07:46	02/08/2012 21:43	TD
96-1	Pyridine	ND		ug/L	3.19	5.00	1	EPA SW-846 8270C	02/08/2012 07:46	02/08/2012 21:43	TD

YORK

ANALYTICAL LABORATORIES, INC.

Sample Information

Client Sample ID: **515W18-SB/MW2-GW**

York Sample ID: **12B0219-02**

York Project (SDG) No.
12B0219

Client Project ID
515 West 18th St.

Matrix
Water

Collection Date/Time
February 6, 2012 3:00 pm

Date Received
02/07/2012

Volatile Organics, 8260 List

Sample Prepared by Method: EPA 5030B

Log-in Notes:

Sample Notes:

CAS No.	Parameter	Result	Flag	Units	MDL	RL	Dilution	Reference Method	Date/Time Prepared	Date/Time Analyzed	Analyst
630-20-6	1,1,1,2-Tetrachloroethane	ND		ug/L	0.54	5.0	1	EPA SW846-8260B	02/09/2012 15:14	02/10/2012 03:52	SS
71-55-6	1,1,1-Trichloroethane	ND		ug/L	0.95	5.0	1	EPA SW846-8260B	02/09/2012 15:14	02/10/2012 03:52	SS
79-34-5	1,1,2,2-Tetrachloroethane	ND		ug/L	0.57	5.0	1	EPA SW846-8260B	02/09/2012 15:14	02/10/2012 03:52	SS
76-13-1	1,1,2-Trichloro-1,2,2-trifluoroethane (Freon 113)	ND		ug/L	0.60	5.0	1	EPA SW846-8260B	02/09/2012 15:14	02/10/2012 03:52	SS
79-00-5	1,1,2-Trichloroethane	ND		ug/L	0.61	5.0	1	EPA SW846-8260B	02/09/2012 15:14	02/10/2012 03:52	SS
75-34-3	1,1-Dichloroethane	ND		ug/L	0.69	5.0	1	EPA SW846-8260B	02/09/2012 15:14	02/10/2012 03:52	SS
75-35-4	1,1-Dichloroethylene	ND		ug/L	1.3	5.0	1	EPA SW846-8260B	02/09/2012 15:14	02/10/2012 03:52	SS
563-58-6	1,1-Dichloropropylene	ND		ug/L	0.43	5.0	1	EPA SW846-8260B	02/09/2012 15:14	02/10/2012 03:52	SS
87-61-6	1,2,3-Trichlorobenzene	ND		ug/L	0.37	10	1	EPA SW846-8260B	02/09/2012 15:14	02/10/2012 03:52	SS
96-18-4	1,2,3-Trichloropropane	ND		ug/L	1.1	5.0	1	EPA SW846-8260B	02/09/2012 15:14	02/10/2012 03:52	SS
120-82-1	1,2,4-Trichlorobenzene	ND		ug/L	0.48	10	1	EPA SW846-8260B	02/09/2012 15:14	02/10/2012 03:52	SS
95-63-6	1,2,4-Trimethylbenzene	0.94	J	ug/L	0.53	5.0	1	EPA SW846-8260B	02/09/2012 15:14	02/10/2012 03:52	SS
3-8	1,2-Dibromo-3-chloropropane	ND		ug/L	1.3	10	1	EPA SW846-8260B	02/09/2012 15:14	02/10/2012 03:52	SS
106-93-4	1,2-Dibromoethane	ND		ug/L	0.68	5.0	1	EPA SW846-8260B	02/09/2012 15:14	02/10/2012 03:52	SS
95-50-1	1,2-Dichlorobenzene	ND		ug/L	0.59	5.0	1	EPA SW846-8260B	02/09/2012 15:14	02/10/2012 03:52	SS
107-06-2	1,2-Dichloroethane	ND		ug/L	0.65	5.0	1	EPA SW846-8260B	02/09/2012 15:14	02/10/2012 03:52	SS
78-87-5	1,2-Dichloropropane	ND		ug/L	0.22	5.0	1	EPA SW846-8260B	02/09/2012 15:14	02/10/2012 03:52	SS
108-67-8	1,3,5-Trimethylbenzene	ND		ug/L	0.37	5.0	1	EPA SW846-8260B	02/09/2012 15:14	02/10/2012 03:52	SS
541-73-1	1,3-Dichlorobenzene	ND		ug/L	0.47	5.0	1	EPA SW846-8260B	02/09/2012 15:14	02/10/2012 03:52	SS
142-28-9	1,3-Dichloropropane	ND		ug/L	0.69	5.0	1	EPA SW846-8260B	02/09/2012 15:14	02/10/2012 03:52	SS
106-46-7	1,4-Dichlorobenzene	ND		ug/L	0.68	5.0	1	EPA SW846-8260B	02/09/2012 15:14	02/10/2012 03:52	SS
594-20-7	2,2-Dichloropropane	ND		ug/L	0.96	5.0	1	EPA SW846-8260B	02/09/2012 15:14	02/10/2012 03:52	SS
78-93-3	2-Butanone	ND		ug/L	2.6	10	1	EPA SW846-8260B	02/09/2012 15:14	02/10/2012 03:52	SS
95-49-8	2-Chlorotoluene	ND		ug/L	0.49	5.0	1	EPA SW846-8260B	02/09/2012 15:14	02/10/2012 03:52	SS
106-43-4	4-Chlorotoluene	ND		ug/L	0.49	5.0	1	EPA SW846-8260B	02/09/2012 15:14	02/10/2012 03:52	SS
67-64-1	Acetone	ND		ug/L	3.1	10	1	EPA SW846-8260B	02/09/2012 15:14	02/10/2012 03:52	SS
71-43-2	Benzene	350		ug/L	2.4	25	5	EPA SW846-8260B	02/09/2012 15:14	02/11/2012 20:54	SS
108-86-1	Bromobenzene	ND		ug/L	0.61	5.0	1	EPA SW846-8260B	02/09/2012 15:14	02/10/2012 03:52	SS
74-97-5	Bromochloromethane	ND		ug/L	1.3	5.0	1	EPA SW846-8260B	02/09/2012 15:14	02/10/2012 03:52	SS
75-27-4	Bromodichloromethane	ND		ug/L	0.62	5.0	1	EPA SW846-8260B	02/09/2012 15:14	02/10/2012 03:52	SS
75-25-2	Bromoform	ND		ug/L	0.58	5.0	1	EPA SW846-8260B	02/09/2012 15:14	02/10/2012 03:52	SS
-9	Bromomethane	ND		ug/L	1.2	5.0	1	EPA SW846-8260B	02/09/2012 15:14	02/10/2012 03:52	SS
56-23-5	Carbon tetrachloride	ND		ug/L	1.0	5.0	1	EPA SW846-8260B	02/09/2012 15:14	02/10/2012 03:52	SS
108-90-7	Chlorobenzene	ND		ug/L	0.35	5.0	1	EPA SW846-8260B	02/09/2012 15:14	02/10/2012 03:52	SS

YORK

ANALYTICAL LABORATORIES, INC.

Sample Information

Client Sample ID: **515W18-SB/MW2-GW**

York Sample ID: **12B0219-02**

York Project (SDG) No.
12B0219

Client Project ID
515 West 18th St.

Matrix
Water

Collection Date/Time
February 6, 2012 3:00 pm

Date Received
02/07/2012

Volatile Organics, 8260 List

Log-in Notes:

Sample Notes:

Sample Prepared by Method: EPA 5030B

CAS No.	Parameter	Result	Flag	Units	MDL	RL	Dilution	Reference Method	Date/Time Prepared	Date/Time Analyzed	Analyst
75-00-3	Chloroethane	ND		ug/L	0.76	5.0	1	EPA SW846-8260B	02/09/2012 15:14	02/10/2012 03:52	SS
67-66-3	Chloroform	ND		ug/L	0.36	5.0	1	EPA SW846-8260B	02/09/2012 15:14	02/10/2012 03:52	SS
74-87-3	Chloromethane	ND		ug/L	0.89	5.0	1	EPA SW846-8260B	02/09/2012 15:14	02/10/2012 03:52	SS
156-59-2	cis-1,2-Dichloroethylene	ND		ug/L	0.96	5.0	1	EPA SW846-8260B	02/09/2012 15:14	02/10/2012 03:52	SS
10061-01-5	cis-1,3-Dichloropropylene	ND		ug/L	0.35	5.0	1	EPA SW846-8260B	02/09/2012 15:14	02/10/2012 03:52	SS
124-48-1	Dibromochloromethane	ND		ug/L	0.67	5.0	1	EPA SW846-8260B	02/09/2012 15:14	02/10/2012 03:52	SS
74-95-3	Dibromomethane	ND		ug/L	1.3	5.0	1	EPA SW846-8260B	02/09/2012 15:14	02/10/2012 03:52	SS
75-71-8	Dichlorodifluoromethane	ND		ug/L	0.83	5.0	1	EPA SW846-8260B	02/09/2012 15:14	02/10/2012 03:52	SS
100-41-4	Ethyl Benzene	1.6	J	ug/L	0.35	5.0	1	EPA SW846-8260B	02/09/2012 15:14	02/10/2012 03:52	SS
87-68-3	Hexachlorobutadiene	ND		ug/L	0.43	5.0	1	EPA SW846-8260B	02/09/2012 15:14	02/10/2012 03:52	SS
98-82-8	Isopropylbenzene	10		ug/L	0.39	5.0	1	EPA SW846-8260B	02/09/2012 15:14	02/10/2012 03:52	SS
1634-04-4	Methyl tert-butyl ether (MTBE)	9.6		ug/L	0.38	5.0	1	EPA SW846-8260B	02/09/2012 15:14	02/10/2012 03:52	SS
79-2	Methylene chloride	4.3	J, B	ug/L	1.1	10	1	EPA SW846-8260B	02/09/2012 15:14	02/10/2012 03:52	SS
120-3	Naphthalene	2.6	J	ug/L	0.50	10	1	EPA SW846-8260B	02/09/2012 15:14	02/10/2012 03:52	SS
104-51-8	n-Butylbenzene	ND		ug/L	0.32	5.0	1	EPA SW846-8260B	02/09/2012 15:14	02/10/2012 03:52	SS
103-65-1	n-Propylbenzene	11		ug/L	0.58	5.0	1	EPA SW846-8260B	02/09/2012 15:14	02/10/2012 03:52	SS
95-47-6	o-Xylene	1.2	J	ug/L	0.50	5.0	1	EPA SW846-8260B	02/09/2012 15:14	02/10/2012 03:52	SS
1330-20-7P/M	p- & m- Xylenes	4.1	J	ug/L	0.55	10	1	EPA SW846-8260B	02/09/2012 15:14	02/10/2012 03:52	SS
99-87-6	p-Isopropyltoluene	ND		ug/L	0.25	5.0	1	EPA SW846-8260B	02/09/2012 15:14	02/10/2012 03:52	SS
135-98-8	sec-Butylbenzene	1.8	J	ug/L	0.52	5.0	1	EPA SW846-8260B	02/09/2012 15:14	02/10/2012 03:52	SS
100-42-5	Styrene	ND		ug/L	0.43	5.0	1	EPA SW846-8260B	02/09/2012 15:14	02/10/2012 03:52	SS
98-06-6	tert-Butylbenzene	ND		ug/L	0.46	5.0	1	EPA SW846-8260B	02/09/2012 15:14	02/10/2012 03:52	SS
127-18-4	Tetrachloroethylene	ND		ug/L	0.52	5.0	1	EPA SW846-8260B	02/09/2012 15:14	02/10/2012 03:52	SS
108-88-3	Toluene	1.5	J	ug/L	0.23	5.0	1	EPA SW846-8260B	02/09/2012 15:14	02/10/2012 03:52	SS
156-60-5	trans-1,2-Dichloroethylene	ND		ug/L	0.65	5.0	1	EPA SW846-8260B	02/09/2012 15:14	02/10/2012 03:52	SS
10061-02-6	trans-1,3-Dichloropropylene	ND		ug/L	0.68	5.0	1	EPA SW846-8260B	02/09/2012 15:14	02/10/2012 03:52	SS
79-01-6	Trichloroethylene	ND		ug/L	0.57	5.0	1	EPA SW846-8260B	02/09/2012 15:14	02/10/2012 03:52	SS
75-69-4	Trichlorofluoromethane	ND		ug/L	0.91	5.0	1	EPA SW846-8260B	02/09/2012 15:14	02/10/2012 03:52	SS
75-01-4	Vinyl Chloride	ND		ug/L	0.97	5.0	1	EPA SW846-8260B	02/09/2012 15:14	02/10/2012 03:52	SS
1330-20-7	Xylenes, Total	5.3	J	ug/L	1.0	15	1	EPA SW846-8260B	02/09/2012 15:14	02/10/2012 03:52	SS

YORK

ANALYTICAL LABORATORIES, INC.

Sample Information

Client Sample ID: 515W18-SB/MW2-GW

York Sample ID: 12B0219-02

York Project (SDG) No.
12B0219

Client Project ID
515 West 18th St.

Matrix
Water

Collection Date/Time
February 6, 2012 3:00 pm

Date Received
02/07/2012

Semi-Volatiles, 8270 Target List

Log-in Notes:

Sample Notes:

Sample Prepared by Method: EPA 3510C

CAS No.	Parameter	Result	Flag	Units	MDL	RL	Dilution	Reference Method	Date/Time Prepared	Date/Time Analyzed	Analyst
120-82-1	1,2,4-Trichlorobenzene	ND		ug/L	1.35	5.13	1	EPA SW-846 8270C	02/08/2012 07:46	02/08/2012 22:15	TD
95-50-1	1,2-Dichlorobenzene	ND		ug/L	1.68	5.13	1	EPA SW-846 8270C	02/08/2012 07:46	02/08/2012 22:15	TD
541-73-1	1,3-Dichlorobenzene	ND		ug/L	2.82	5.13	1	EPA SW-846 8270C	02/08/2012 07:46	02/08/2012 22:15	TD
106-46-7	1,4-Dichlorobenzene	ND		ug/L	3.31	5.13	1	EPA SW-846 8270C	02/08/2012 07:46	02/08/2012 22:15	TD
95-95-4	2,4,5-Trichlorophenol	ND		ug/L	3.70	5.13	1	EPA SW-846 8270C	02/08/2012 07:46	02/08/2012 22:15	TD
88-06-2	2,4,6-Trichlorophenol	ND		ug/L	3.36	5.13	1	EPA SW-846 8270C	02/08/2012 07:46	02/08/2012 22:15	TD
120-83-2	2,4-Dichlorophenol	ND		ug/L	3.17	5.13	1	EPA SW-846 8270C	02/08/2012 07:46	02/08/2012 22:15	TD
105-67-9	2,4-Dimethylphenol	ND		ug/L	3.78	5.13	1	EPA SW-846 8270C	02/08/2012 07:46	02/08/2012 22:15	TD
51-28-5	2,4-Dinitrophenol	ND		ug/L	9.85	10.3	1	EPA SW-846 8270C	02/08/2012 07:46	02/08/2012 22:15	TD
121-14-2	2,4-Dinitrotoluene	ND		ug/L	2.43	5.13	1	EPA SW-846 8270C	02/08/2012 07:46	02/08/2012 22:15	TD
606-20-2	2,6-Dinitrotoluene	ND		ug/L	3.60	5.13	1	EPA SW-846 8270C	02/08/2012 07:46	02/08/2012 22:15	TD
91-58-7	2-Chloronaphthalene	ND		ug/L	3.58	5.13	1	EPA SW-846 8270C	02/08/2012 07:46	02/08/2012 22:15	TD
7-8	2-Chlorophenol	ND		ug/L	3.50	5.13	1	EPA SW-846 8270C	02/08/2012 07:46	02/08/2012 22:15	TD
91-57-6	2-Methylnaphthalene	ND		ug/L	3.15	5.13	1	EPA SW-846 8270C	02/08/2012 07:46	02/08/2012 22:15	TD
95-48-7	2-Methylphenol	ND		ug/L	0.879	5.13	1	EPA SW-846 8270C	02/08/2012 07:46	02/08/2012 22:15	TD
88-74-4	2-Nitroaniline	ND		ug/L	3.08	5.13	1	EPA SW-846 8270C	02/08/2012 07:46	02/08/2012 22:15	TD
88-75-5	2-Nitrophenol	ND		ug/L	3.18	5.13	1	EPA SW-846 8270C	02/08/2012 07:46	02/08/2012 22:15	TD
100-01-6	3- & 4-Methylphenols	ND		ug/L	3.81	5.13	1	EPA SW-846 8270C	02/08/2012 07:46	02/08/2012 22:15	TD
91-94-1	3,3'-Dichlorobenzidine	ND		ug/L	3.60	5.13	1	EPA SW-846 8270C	02/08/2012 07:46	02/08/2012 22:15	TD
99-09-2	3-Nitroaniline	ND		ug/L	1.64	5.13	1	EPA SW-846 8270C	02/08/2012 07:46	02/08/2012 22:15	TD
534-52-1	4,6-Dinitro-2-methylphenol	ND		ug/L	6.87	10.3	1	EPA SW-846 8270C	02/08/2012 07:46	02/08/2012 22:15	TD
101-55-3	4-Bromophenyl phenyl ether	ND		ug/L	3.53	5.13	1	EPA SW-846 8270C	02/08/2012 07:46	02/08/2012 22:15	TD
59-50-7	4-Chloro-3-methylphenol	ND		ug/L	3.72	5.13	1	EPA SW-846 8270C	02/08/2012 07:46	02/08/2012 22:15	TD
106-47-8	4-Chloroaniline	ND		ug/L	3.84	5.13	1	EPA SW-846 8270C	02/08/2012 07:46	02/08/2012 22:15	TD
7005-72-3	4-Chlorophenyl phenyl ether	ND		ug/L	3.20	5.13	1	EPA SW-846 8270C	02/08/2012 07:46	02/08/2012 22:15	TD
100-02-7	4-Nitroaniline	ND		ug/L	3.87	5.13	1	EPA SW-846 8270C	02/08/2012 07:46	02/08/2012 22:15	TD
56-57-5	4-Nitrophenol	ND		ug/L	4.04	5.13	1	EPA SW-846 8270C	02/08/2012 07:46	02/08/2012 22:15	TD
83-32-9	Acenaphthene	ND		ug/L	3.32	5.13	1	EPA SW-846 8270C	02/08/2012 07:46	02/08/2012 22:15	TD
208-96-8	Acenaphthylene	ND		ug/L	4.38	5.13	1	EPA SW-846 8270C	02/08/2012 07:46	02/08/2012 22:15	TD
62-53-3	Aniline	ND		ug/L	2.02	5.13	1	EPA SW-846 8270C	02/08/2012 07:46	02/08/2012 22:15	TD
120-12-7	Anthracene	ND		ug/L	3.75	5.13	1	EPA SW-846 8270C	02/08/2012 07:46	02/08/2012 22:15	TD
15-3	Benzo(a)anthracene	ND		ug/L	4.17	5.13	1	EPA SW-846 8270C	02/08/2012 07:46	02/08/2012 22:15	TD
30-32-8	Benzo(a)pyrene	ND		ug/L	4.97	5.13	1	EPA SW-846 8270C	02/08/2012 07:46	02/08/2012 22:15	TD
205-99-2	Benzo(b)fluoranthene	ND		ug/L	4.23	5.13	1	EPA SW-846 8270C	02/08/2012 07:46	02/08/2012 22:15	TD
191-24-2	Benzo(g,h,i)perylene	ND		ug/L	4.26	5.13	1	EPA SW-846 8270C	02/08/2012 07:46	02/08/2012 22:15	TD

YORK

ANALYTICAL LABORATORIES, INC.

Sample Information

Client Sample ID: 515W18-SB/MW2-GW

York Sample ID: 12B0219-02

York Project (SDG) No.

Client Project ID

Matrix

Collection Date/Time

Date Received

12B0219

515 West 18th St.

Water

February 6, 2012 3:00 pm

02/07/2012

Semi-Volatiles, 8270 Target List

Log-in Notes:

Sample Notes:

Sample Prepared by Method: EPA 3510C

CAS No.	Parameter	Result	Flag	Units	MDL	RL	Dilution	Reference Method	Date/Time Prepared	Date/Time Analyzed	Analyst
207-08-9	Benzo(k)fluoranthene	ND		ug/L	3.54	5.13	1	EPA SW-846 8270C	02/08/2012 07:46	02/08/2012 22:15	TD
100-51-6	Benzyl alcohol	ND		ug/L	4.10	5.13	1	EPA SW-846 8270C	02/08/2012 07:46	02/08/2012 22:15	TD
85-68-7	Benzyl butyl phthalate	ND		ug/L	2.36	5.13	1	EPA SW-846 8270C	02/08/2012 07:46	02/08/2012 22:15	TD
111-91-1	Bis(2-chloroethoxy)methane	ND		ug/L	4.97	5.13	1	EPA SW-846 8270C	02/08/2012 07:46	02/08/2012 22:15	TD
111-44-4	Bis(2-chloroethyl)ether	ND		ug/L	4.23	5.13	1	EPA SW-846 8270C	02/08/2012 07:46	02/08/2012 22:15	TD
108-60-1	Bis(2-chloroisopropyl)ether	ND		ug/L	4.26	5.13	1	EPA SW-846 8270C	02/08/2012 07:46	02/08/2012 22:15	TD
117-81-7	Bis(2-ethylhexyl)phthalate	ND		ug/L	2.64	5.13	1	EPA SW-846 8270C	02/08/2012 07:46	02/08/2012 22:15	TD
218-01-9	Chrysene	ND		ug/L	4.26	5.13	1	EPA SW-846 8270C	02/08/2012 07:46	02/08/2012 22:15	TD
53-70-3	Dibenzo(a,h)anthracene	ND		ug/L	3.18	5.13	1	EPA SW-846 8270C	02/08/2012 07:46	02/08/2012 22:15	TD
132-64-9	Dibenzofuran	ND		ug/L	2.97	5.13	1	EPA SW-846 8270C	02/08/2012 07:46	02/08/2012 22:15	TD
84-66-2	Diethyl phthalate	ND		ug/L	2.26	5.13	1	EPA SW-846 8270C	02/08/2012 07:46	02/08/2012 22:15	TD
131-11-3	Dimethyl phthalate	ND		ug/L	4.97	5.13	1	EPA SW-846 8270C	02/08/2012 07:46	02/08/2012 22:15	TD
2	Di-n-butyl phthalate	ND		ug/L	4.23	5.13	1	EPA SW-846 8270C	02/08/2012 07:46	02/08/2012 22:15	TD
117-84-0	Di-n-octyl phthalate	ND		ug/L	4.26	5.13	1	EPA SW-846 8270C	02/08/2012 07:46	02/08/2012 22:15	TD
206-44-0	Fluoranthene	ND		ug/L	1.64	5.13	1	EPA SW-846 8270C	02/08/2012 07:46	02/08/2012 22:15	TD
86-73-7	Fluorene	ND		ug/L	3.31	5.13	1	EPA SW-846 8270C	02/08/2012 07:46	02/08/2012 22:15	TD
118-74-1	Hexachlorobenzene	ND		ug/L	3.03	5.13	1	EPA SW-846 8270C	02/08/2012 07:46	02/08/2012 22:15	TD
87-68-3	Hexachlorobutadiene	ND		ug/L	3.39	5.13	1	EPA SW-846 8270C	02/08/2012 07:46	02/08/2012 22:15	TD
77-47-4	Hexachlorocyclopentadiene	ND		ug/L	3.53	5.13	1	EPA SW-846 8270C	02/08/2012 07:46	02/08/2012 22:15	TD
67-72-1	Hexachloroethane	ND		ug/L	3.72	5.13	1	EPA SW-846 8270C	02/08/2012 07:46	02/08/2012 22:15	TD
193-39-5	Indeno(1,2,3-cd)pyrene	ND		ug/L	2.82	5.13	1	EPA SW-846 8270C	02/08/2012 07:46	02/08/2012 22:15	TD
78-59-1	Isophorone	ND		ug/L	3.31	5.13	1	EPA SW-846 8270C	02/08/2012 07:46	02/08/2012 22:15	TD
91-20-3	Naphthalene	ND		ug/L	3.96	5.13	1	EPA SW-846 8270C	02/08/2012 07:46	02/08/2012 22:15	TD
98-95-3	Nitrobenzene	ND		ug/L	2.02	5.13	1	EPA SW-846 8270C	02/08/2012 07:46	02/08/2012 22:15	TD
62-75-9	N-Nitrosodimethylamine	ND		ug/L	3.18	5.13	1	EPA SW-846 8270C	02/08/2012 07:46	02/08/2012 22:15	TD
621-64-7	N-nitroso-di-n-propylamine	ND		ug/L	2.64	5.13	1	EPA SW-846 8270C	02/08/2012 07:46	02/08/2012 22:15	TD
86-30-6	N-Nitrosodiphenylamine	ND		ug/L	3.71	5.13	1	EPA SW-846 8270C	02/08/2012 07:46	02/08/2012 22:15	TD
87-86-5	Pentachlorophenol	ND		ug/L	3.86	5.13	1	EPA SW-846 8270C	02/08/2012 07:46	02/08/2012 22:15	TD
85-01-8	Phenanthrene	ND		ug/L	3.70	5.13	1	EPA SW-846 8270C	02/08/2012 07:46	02/08/2012 22:15	TD
108-95-2	Phenol	ND		ug/L	3.36	5.13	1	EPA SW-846 8270C	02/08/2012 07:46	02/08/2012 22:15	TD
129-00-0	Pyrene	ND		ug/L	2.43	5.13	1	EPA SW-846 8270C	02/08/2012 07:46	02/08/2012 22:15	TD
6-1	Pyridine	ND		ug/L	3.27	5.13	1	EPA SW-846 8270C	02/08/2012 07:46	02/08/2012 22:15	TD

YORK

ANALYTICAL LABORATORIES, INC.

Sample Information

Client Sample ID: 515W18-SB/MW3-GW

York Sample ID: 12B0219-03

York Project (SDG) No.

Client Project ID

Matrix

Collection Date/Time

Date Received

12B0219

515 West 18th St.

Water

February 6, 2012 3:00 pm

02/07/2012

Volatiles Organics, 8260 List

Log-in Notes:

Sample Notes:

Sample Prepared by Method: EPA 5030B

CAS No.	Parameter	Result	Flag	Units	MDL	RL	Dilution	Reference Method	Date/Time Prepared	Date/Time Analyzed	Analyst
630-20-6	1,1,1,2-Tetrachloroethane	ND		ug/L	0.54	5.0	1	EPA SW846-8260B	02/09/2012 15:14	02/10/2012 04:29	SS
71-55-6	1,1,1-Trichloroethane	ND		ug/L	0.95	5.0	1	EPA SW846-8260B	02/09/2012 15:14	02/10/2012 04:29	SS
79-34-5	1,1,2,2-Tetrachloroethane	ND		ug/L	0.57	5.0	1	EPA SW846-8260B	02/09/2012 15:14	02/10/2012 04:29	SS
76-13-1	1,1,2-Trichloro-1,2,2-trifluoroethane (Freon 113)	ND		ug/L	0.60	5.0	1	EPA SW846-8260B	02/09/2012 15:14	02/10/2012 04:29	SS
79-00-5	1,1,2-Trichloroethane	ND		ug/L	0.61	5.0	1	EPA SW846-8260B	02/09/2012 15:14	02/10/2012 04:29	SS
75-34-3	1,1-Dichloroethane	ND		ug/L	0.69	5.0	1	EPA SW846-8260B	02/09/2012 15:14	02/10/2012 04:29	SS
75-35-4	1,1-Dichloroethylene	ND		ug/L	1.3	5.0	1	EPA SW846-8260B	02/09/2012 15:14	02/10/2012 04:29	SS
563-58-6	1,1-Dichloropropylene	ND		ug/L	0.43	5.0	1	EPA SW846-8260B	02/09/2012 15:14	02/10/2012 04:29	SS
87-61-6	1,2,3-Trichlorobenzene	ND		ug/L	0.37	10	1	EPA SW846-8260B	02/09/2012 15:14	02/10/2012 04:29	SS
96-18-4	1,2,3-Trichloropropane	ND		ug/L	1.1	5.0	1	EPA SW846-8260B	02/09/2012 15:14	02/10/2012 04:29	SS
120-82-1	1,2,4-Trichlorobenzene	ND		ug/L	0.48	10	1	EPA SW846-8260B	02/09/2012 15:14	02/10/2012 04:29	SS
95-63-6	1,2,4-Trimethylbenzene	8.2		ug/L	0.53	5.0	1	EPA SW846-8260B	02/09/2012 15:14	02/10/2012 04:29	SS
-8	1,2-Dibromo-3-chloropropane	ND		ug/L	1.3	10	1	EPA SW846-8260B	02/09/2012 15:14	02/10/2012 04:29	SS
106-93-4	1,2-Dibromoethane	ND		ug/L	0.68	5.0	1	EPA SW846-8260B	02/09/2012 15:14	02/10/2012 04:29	SS
95-50-1	1,2-Dichlorobenzene	ND		ug/L	0.59	5.0	1	EPA SW846-8260B	02/09/2012 15:14	02/10/2012 04:29	SS
107-06-2	1,2-Dichloroethane	ND		ug/L	0.65	5.0	1	EPA SW846-8260B	02/09/2012 15:14	02/10/2012 04:29	SS
78-87-5	1,2-Dichloropropane	ND		ug/L	0.22	5.0	1	EPA SW846-8260B	02/09/2012 15:14	02/10/2012 04:29	SS
108-67-8	1,3,5-Trimethylbenzene	2.9		ug/L	0.37	5.0	1	EPA SW846-8260B	02/09/2012 15:14	02/10/2012 04:29	SS
541-73-1	1,3-Dichlorobenzene	ND		ug/L	0.47	5.0	1	EPA SW846-8260B	02/09/2012 15:14	02/10/2012 04:29	SS
142-28-9	1,3-Dichloropropane	ND		ug/L	0.69	5.0	1	EPA SW846-8260B	02/09/2012 15:14	02/10/2012 04:29	SS
106-46-7	1,4-Dichlorobenzene	ND		ug/L	0.68	5.0	1	EPA SW846-8260B	02/09/2012 15:14	02/10/2012 04:29	SS
594-20-7	2,2-Dichloropropane	ND		ug/L	0.96	5.0	1	EPA SW846-8260B	02/09/2012 15:14	02/10/2012 04:29	SS
78-93-3	2-Butanone	ND		ug/L	2.6	10	1	EPA SW846-8260B	02/09/2012 15:14	02/10/2012 04:29	SS
95-49-8	2-Chlorotoluene	ND		ug/L	0.49	5.0	1	EPA SW846-8260B	02/09/2012 15:14	02/10/2012 04:29	SS
106-43-4	4-Chlorotoluene	ND		ug/L	0.49	5.0	1	EPA SW846-8260B	02/09/2012 15:14	02/10/2012 04:29	SS
67-64-1	Acetone	ND		ug/L	3.1	10	1	EPA SW846-8260B	02/09/2012 15:14	02/10/2012 04:29	SS
71-43-2	Benzene	120		ug/L	0.48	5.0	1	EPA SW846-8260B	02/09/2012 15:14	02/10/2012 04:29	SS
108-86-1	Bromobenzene	ND		ug/L	0.61	5.0	1	EPA SW846-8260B	02/09/2012 15:14	02/10/2012 04:29	SS
74-97-5	Bromochloromethane	ND		ug/L	1.3	5.0	1	EPA SW846-8260B	02/09/2012 15:14	02/10/2012 04:29	SS
75-27-4	Bromodichloromethane	ND		ug/L	0.62	5.0	1	EPA SW846-8260B	02/09/2012 15:14	02/10/2012 04:29	SS
75-25-2	Bromoform	ND		ug/L	0.58	5.0	1	EPA SW846-8260B	02/09/2012 15:14	02/10/2012 04:29	SS
-9	Bromomethane	ND		ug/L	1.2	5.0	1	EPA SW846-8260B	02/09/2012 15:14	02/10/2012 04:29	SS
56-23-5	Carbon tetrachloride	ND		ug/L	1.0	5.0	1	EPA SW846-8260B	02/09/2012 15:14	02/10/2012 04:29	SS
108-90-7	Chlorobenzene	ND		ug/L	0.35	5.0	1	EPA SW846-8260B	02/09/2012 15:14	02/10/2012 04:29	SS

YORK

ANALYTICAL LABORATORIES, INC.

Sample Information

Client Sample ID: 515W18-SB/MW3-GW

York Sample ID: 12B0219-03

York Project (SDG) No.
12B0219

Client Project ID
515 West 18th St.

Matrix
Water

Collection Date/Time
February 6, 2012 3:00 pm

Date Received
02/07/2012

Volatile Organics, 8260 List

Log-in Notes:

Sample Notes:

Sample Prepared by Method: EPA 5030B

CAS No.	Parameter	Result	Flag	Units	MDL	RL	Dilution	Reference Method	Date/Time Prepared	Date/Time Analyzed	Analyst
75-00-3	Chloroethane	ND		ug/L	0.76	5.0	1	EPA SW846-8260B	02/09/2012 15:14	02/10/2012 04:29	SS
67-66-3	Chloroform	ND		ug/L	0.36	5.0	1	EPA SW846-8260B	02/09/2012 15:14	02/10/2012 04:29	SS
74-87-3	Chloromethane	ND		ug/L	0.89	5.0	1	EPA SW846-8260B	02/09/2012 15:14	02/10/2012 04:29	SS
156-59-2	cis-1,2-Dichloroethylene	ND		ug/L	0.96	5.0	1	EPA SW846-8260B	02/09/2012 15:14	02/10/2012 04:29	SS
10061-01-5	cis-1,3-Dichloropropylene	ND		ug/L	0.35	5.0	1	EPA SW846-8260B	02/09/2012 15:14	02/10/2012 04:29	SS
124-48-1	Dibromochloromethane	ND		ug/L	0.67	5.0	1	EPA SW846-8260B	02/09/2012 15:14	02/10/2012 04:29	SS
74-95-3	Dibromomethane	ND		ug/L	1.3	5.0	1	EPA SW846-8260B	02/09/2012 15:14	02/10/2012 04:29	SS
75-71-8	Dichlorodifluoromethane	ND		ug/L	0.83	5.0	1	EPA SW846-8260B	02/09/2012 15:14	02/10/2012 04:29	SS
100-41-4	Ethyl Benzene	8.0		ug/L	0.35	5.0	1	EPA SW846-8260B	02/09/2012 15:14	02/10/2012 04:29	SS
87-68-3	Hexachlorobutadiene	ND		ug/L	0.43	5.0	1	EPA SW846-8260B	02/09/2012 15:14	02/10/2012 04:29	SS
98-82-8	Isopropylbenzene	2.0	J	ug/L	0.39	5.0	1	EPA SW846-8260B	02/09/2012 15:14	02/10/2012 04:29	SS
1634-04-4	Methyl tert-butyl ether (MTBE)	6.2		ug/L	0.38	5.0	1	EPA SW846-8260B	02/09/2012 15:14	02/10/2012 04:29	SS
100-42-2	Methylene chloride	4.0	J, B	ug/L	1.1	10	1	EPA SW846-8260B	02/09/2012 15:14	02/10/2012 04:29	SS
100-52-3	Naphthalene	5.2	J	ug/L	0.50	10	1	EPA SW846-8260B	02/09/2012 15:14	02/10/2012 04:29	SS
104-51-8	n-Butylbenzene	0.91	J	ug/L	0.32	5.0	1	EPA SW846-8260B	02/09/2012 15:14	02/10/2012 04:29	SS
103-65-1	n-Propylbenzene	1.9	J	ug/L	0.58	5.0	1	EPA SW846-8260B	02/09/2012 15:14	02/10/2012 04:29	SS
95-47-6	o-Xylene	7.9		ug/L	0.50	5.0	1	EPA SW846-8260B	02/09/2012 15:14	02/10/2012 04:29	SS
1330-20-7P/M	p- & m- Xylenes	17		ug/L	0.55	10	1	EPA SW846-8260B	02/09/2012 15:14	02/10/2012 04:29	SS
99-87-6	p-Isopropyltoluene	ND		ug/L	0.25	5.0	1	EPA SW846-8260B	02/09/2012 15:14	02/10/2012 04:29	SS
135-98-8	sec-Butylbenzene	ND		ug/L	0.52	5.0	1	EPA SW846-8260B	02/09/2012 15:14	02/10/2012 04:29	SS
100-42-5	Styrene	ND		ug/L	0.43	5.0	1	EPA SW846-8260B	02/09/2012 15:14	02/10/2012 04:29	SS
98-06-6	tert-Butylbenzene	ND		ug/L	0.46	5.0	1	EPA SW846-8260B	02/09/2012 15:14	02/10/2012 04:29	SS
127-18-4	Tetrachloroethylene	ND		ug/L	0.52	5.0	1	EPA SW846-8260B	02/09/2012 15:14	02/10/2012 04:29	SS
108-88-3	Toluene	1.3	J	ug/L	0.23	5.0	1	EPA SW846-8260B	02/09/2012 15:14	02/10/2012 04:29	SS
156-60-5	trans-1,2-Dichloroethylene	ND		ug/L	0.65	5.0	1	EPA SW846-8260B	02/09/2012 15:14	02/10/2012 04:29	SS
10061-02-6	trans-1,3-Dichloropropylene	ND		ug/L	0.68	5.0	1	EPA SW846-8260B	02/09/2012 15:14	02/10/2012 04:29	SS
79-01-6	Trichloroethylene	ND		ug/L	0.57	5.0	1	EPA SW846-8260B	02/09/2012 15:14	02/10/2012 04:29	SS
75-69-4	Trichlorofluoromethane	ND		ug/L	0.91	5.0	1	EPA SW846-8260B	02/09/2012 15:14	02/10/2012 04:29	SS
75-01-4	Vinyl Chloride	ND		ug/L	0.97	5.0	1	EPA SW846-8260B	02/09/2012 15:14	02/10/2012 04:29	SS
1330-20-7	Xylenes, Total	25		ug/L	1.0	15	1	EPA SW846-8260B	02/09/2012 15:14	02/10/2012 04:29	SS

YORK

ANALYTICAL LABORATORIES, INC.

Sample Information

Client Sample ID: 515W18-SB/MW3-GW

York Sample ID: 12B0219-03

York Project (SDG) No.
12B0219

Client Project ID
515 West 18th St.

Matrix
Water

Collection Date/Time
February 6, 2012 3:00 pm

Date Received
02/07/2012

Semi-Volatiles, 8270 Target List

Log-in Notes:

Sample Notes:

Sample Prepared by Method: EPA 3510C

CAS No.	Parameter	Result	Flag	Units	MDL	RL	Dilution	Reference Method	Date/Time Prepared	Date/Time Analyzed	Analyst
120-82-1	1,2,4-Trichlorobenzene	ND		ug/L	15.0	57.1	10	EPA SW-846 8270C	02/08/2012 07:46	02/10/2012 04:00	TD
95-50-1	1,2-Dichlorobenzene	ND		ug/L	18.7	57.1	10	EPA SW-846 8270C	02/08/2012 07:46	02/10/2012 04:00	TD
541-73-1	1,3-Dichlorobenzene	ND		ug/L	31.4	57.1	10	EPA SW-846 8270C	02/08/2012 07:46	02/10/2012 04:00	TD
106-46-7	1,4-Dichlorobenzene	ND		ug/L	36.9	57.1	10	EPA SW-846 8270C	02/08/2012 07:46	02/10/2012 04:00	TD
95-95-4	2,4,5-Trichlorophenol	ND		ug/L	41.2	57.1	10	EPA SW-846 8270C	02/08/2012 07:46	02/10/2012 04:00	TD
88-06-2	2,4,6-Trichlorophenol	ND		ug/L	37.4	57.1	10	EPA SW-846 8270C	02/08/2012 07:46	02/10/2012 04:00	TD
120-83-2	2,4-Dichlorophenol	ND		ug/L	35.3	57.1	10	EPA SW-846 8270C	02/08/2012 07:46	02/10/2012 04:00	TD
105-67-9	2,4-Dimethylphenol	ND		ug/L	42.1	57.1	10	EPA SW-846 8270C	02/08/2012 07:46	02/10/2012 04:00	TD
51-28-5	2,4-Dinitrophenol	ND		ug/L	110	114	10	EPA SW-846 8270C	02/08/2012 07:46	02/10/2012 04:00	TD
121-14-2	2,4-Dinitrotoluene	ND		ug/L	27.0	57.1	10	EPA SW-846 8270C	02/08/2012 07:46	02/10/2012 04:00	TD
606-20-2	2,6-Dinitrotoluene	ND		ug/L	40.1	57.1	10	EPA SW-846 8270C	02/08/2012 07:46	02/10/2012 04:00	TD
91-58-7	2-Chloronaphthalene	ND		ug/L	39.9	57.1	10	EPA SW-846 8270C	02/08/2012 07:46	02/10/2012 04:00	TD
-8	2-Chlorophenol	ND		ug/L	39.0	57.1	10	EPA SW-846 8270C	02/08/2012 07:46	02/10/2012 04:00	TD
91-57-6	2-Methylnaphthalene	ND		ug/L	35.1	57.1	10	EPA SW-846 8270C	02/08/2012 07:46	02/10/2012 04:00	TD
95-48-7	2-Methylphenol	ND		ug/L	9.80	57.1	10	EPA SW-846 8270C	02/08/2012 07:46	02/10/2012 04:00	TD
88-74-4	2-Nitroaniline	ND		ug/L	34.4	57.1	10	EPA SW-846 8270C	02/08/2012 07:46	02/10/2012 04:00	TD
88-75-5	2-Nitrophenol	ND		ug/L	35.5	57.1	10	EPA SW-846 8270C	02/08/2012 07:46	02/10/2012 04:00	TD
100-01-6	3- & 4-Methylphenols	ND		ug/L	42.5	57.1	10	EPA SW-846 8270C	02/08/2012 07:46	02/10/2012 04:00	TD
91-94-1	3,3'-Dichlorobenzidine	ND		ug/L	40.1	57.1	10	EPA SW-846 8270C	02/08/2012 07:46	02/10/2012 04:00	TD
99-09-2	3-Nitroaniline	ND		ug/L	18.2	57.1	10	EPA SW-846 8270C	02/08/2012 07:46	02/10/2012 04:00	TD
534-52-1	4,6-Dinitro-2-methylphenol	ND		ug/L	76.6	114	10	EPA SW-846 8270C	02/08/2012 07:46	02/10/2012 04:00	TD
101-55-3	4-Bromophenyl phenyl ether	ND		ug/L	39.4	57.1	10	EPA SW-846 8270C	02/08/2012 07:46	02/10/2012 04:00	TD
59-50-7	4-Chloro-3-methylphenol	ND		ug/L	41.5	57.1	10	EPA SW-846 8270C	02/08/2012 07:46	02/10/2012 04:00	TD
106-47-8	4-Chloroaniline	ND		ug/L	42.7	57.1	10	EPA SW-846 8270C	02/08/2012 07:46	02/10/2012 04:00	TD
7005-72-3	4-Chlorophenyl phenyl ether	ND		ug/L	35.7	57.1	10	EPA SW-846 8270C	02/08/2012 07:46	02/10/2012 04:00	TD
100-02-7	4-Nitroaniline	ND		ug/L	43.1	57.1	10	EPA SW-846 8270C	02/08/2012 07:46	02/10/2012 04:00	TD
56-57-5	4-Nitrophenol	ND		ug/L	45.0	57.1	10	EPA SW-846 8270C	02/08/2012 07:46	02/10/2012 04:00	TD
83-32-9	Acenaphthene	ND		ug/L	37.0	57.1	10	EPA SW-846 8270C	02/08/2012 07:46	02/10/2012 04:00	TD
208-96-8	Acenaphthylene	ND		ug/L	48.9	57.1	10	EPA SW-846 8270C	02/08/2012 07:46	02/10/2012 04:00	TD
62-53-3	Aniline	ND		ug/L	22.5	57.1	10	EPA SW-846 8270C	02/08/2012 07:46	02/10/2012 04:00	TD
120-12-7	Anthracene	ND		ug/L	41.8	57.1	10	EPA SW-846 8270C	02/08/2012 07:46	02/10/2012 04:00	TD
-3	Benzo(a)anthracene	ND		ug/L	46.5	57.1	10	EPA SW-846 8270C	02/08/2012 07:46	02/10/2012 04:00	TD
50-52-8	Benzo(a)pyrene	ND		ug/L	55.4	57.1	10	EPA SW-846 8270C	02/08/2012 07:46	02/10/2012 04:00	TD
205-99-2	Benzo(b)fluoranthene	ND		ug/L	47.1	57.1	10	EPA SW-846 8270C	02/08/2012 07:46	02/10/2012 04:00	TD
191-24-2	Benzo(g,h,i)perylene	ND		ug/L	47.5	57.1	10	EPA SW-846 8270C	02/08/2012 07:46	02/10/2012 04:00	TD

YORK

ANALYTICAL LABORATORIES, INC.

Sample Information

Client Sample ID: 515W18-SB/MW3-GW

York Sample ID: 12B0219-03

York Project (SDG) No.
12B0219

Client Project ID
515 West 18th St.

Matrix
Water

Collection Date/Time
February 6, 2012 3:00 pm

Date Received
02/07/2012

Semi-Volatiles, 8270 Target List

Log-in Notes:

Sample Notes:

Sample Prepared by Method: EPA 3510C

CAS No.	Parameter	Result	Flag	Units	MDL	RL	Dilution	Reference Method	Date/Time Prepared	Date/Time Analyzed	Analyst
207-08-9	Benzo(k)fluoranthene	ND		ug/L	39.5	57.1	10	EPA SW-846 8270C	02/08/2012 07:46	02/10/2012 04:00	TD
100-51-6	Benzyl alcohol	ND		ug/L	45.7	57.1	10	EPA SW-846 8270C	02/08/2012 07:46	02/10/2012 04:00	TD
85-68-7	Benzyl butyl phthalate	ND		ug/L	26.3	57.1	10	EPA SW-846 8270C	02/08/2012 07:46	02/10/2012 04:00	TD
111-91-1	Bis(2-chloroethoxy)methane	ND		ug/L	55.4	57.1	10	EPA SW-846 8270C	02/08/2012 07:46	02/10/2012 04:00	TD
111-44-4	Bis(2-chloroethyl)ether	ND		ug/L	47.1	57.1	10	EPA SW-846 8270C	02/08/2012 07:46	02/10/2012 04:00	TD
108-60-1	Bis(2-chloroisopropyl)ether	ND		ug/L	47.5	57.1	10	EPA SW-846 8270C	02/08/2012 07:46	02/10/2012 04:00	TD
117-81-7	Bis(2-ethylhexyl)phthalate	634		ug/L	29.4	57.1	10	EPA SW-846 8270C	02/08/2012 07:46	02/10/2012 04:00	TD
218-01-9	Chrysene	ND		ug/L	47.5	57.1	10	EPA SW-846 8270C	02/08/2012 07:46	02/10/2012 04:00	TD
53-70-3	Dibenzo(a,h)anthracene	ND		ug/L	35.4	57.1	10	EPA SW-846 8270C	02/08/2012 07:46	02/10/2012 04:00	TD
132-64-9	Dibenzofuran	ND		ug/L	33.1	57.1	10	EPA SW-846 8270C	02/08/2012 07:46	02/10/2012 04:00	TD
84-66-2	Diethyl phthalate	ND		ug/L	25.1	57.1	10	EPA SW-846 8270C	02/08/2012 07:46	02/10/2012 04:00	TD
131-11-3	Dimethyl phthalate	ND		ug/L	55.4	57.1	10	EPA SW-846 8270C	02/08/2012 07:46	02/10/2012 04:00	TD
-2	Di-n-butyl phthalate	ND		ug/L	47.1	57.1	10	EPA SW-846 8270C	02/08/2012 07:46	02/10/2012 04:00	TD
117-84-0	Di-n-octyl phthalate	ND		ug/L	47.5	57.1	10	EPA SW-846 8270C	02/08/2012 07:46	02/10/2012 04:00	TD
206-44-0	Fluoranthene	ND		ug/L	18.2	57.1	10	EPA SW-846 8270C	02/08/2012 07:46	02/10/2012 04:00	TD
86-73-7	Fluorene	ND		ug/L	36.9	57.1	10	EPA SW-846 8270C	02/08/2012 07:46	02/10/2012 04:00	TD
118-74-1	Hexachlorobenzene	ND		ug/L	33.8	57.1	10	EPA SW-846 8270C	02/08/2012 07:46	02/10/2012 04:00	TD
87-68-3	Hexachlorobutadiene	ND		ug/L	37.8	57.1	10	EPA SW-846 8270C	02/08/2012 07:46	02/10/2012 04:00	TD
77-47-4	Hexachlorocyclopentadiene	ND		ug/L	39.4	57.1	10	EPA SW-846 8270C	02/08/2012 07:46	02/10/2012 04:00	TD
67-72-1	Hexachloroethane	ND		ug/L	41.5	57.1	10	EPA SW-846 8270C	02/08/2012 07:46	02/10/2012 04:00	TD
193-39-5	Indeno(1,2,3-cd)pyrene	ND		ug/L	31.4	57.1	10	EPA SW-846 8270C	02/08/2012 07:46	02/10/2012 04:00	TD
78-59-1	Isophorone	ND		ug/L	36.9	57.1	10	EPA SW-846 8270C	02/08/2012 07:46	02/10/2012 04:00	TD
91-20-3	Naphthalene	ND		ug/L	44.1	57.1	10	EPA SW-846 8270C	02/08/2012 07:46	02/10/2012 04:00	TD
98-95-3	Nitrobenzene	ND		ug/L	22.5	57.1	10	EPA SW-846 8270C	02/08/2012 07:46	02/10/2012 04:00	TD
62-75-9	N-Nitrosodimethylamine	ND		ug/L	35.5	57.1	10	EPA SW-846 8270C	02/08/2012 07:46	02/10/2012 04:00	TD
621-64-7	N-nitroso-di-n-propylamine	ND		ug/L	29.4	57.1	10	EPA SW-846 8270C	02/08/2012 07:46	02/10/2012 04:00	TD
86-30-6	N-Nitrosodiphenylamine	ND		ug/L	41.4	57.1	10	EPA SW-846 8270C	02/08/2012 07:46	02/10/2012 04:00	TD
87-86-5	Pentachlorophenol	ND		ug/L	43.0	57.1	10	EPA SW-846 8270C	02/08/2012 07:46	02/10/2012 04:00	TD
85-01-8	Phenanthrene	ND		ug/L	41.2	57.1	10	EPA SW-846 8270C	02/08/2012 07:46	02/10/2012 04:00	TD
108-95-2	Phenol	ND		ug/L	37.4	57.1	10	EPA SW-846 8270C	02/08/2012 07:46	02/10/2012 04:00	TD
129-00-0	Pyrene	ND		ug/L	27.0	57.1	10	EPA SW-846 8270C	02/08/2012 07:46	02/10/2012 04:00	TD
123-61	Pyridine	ND		ug/L	36.4	57.1	10	EPA SW-846 8270C	02/08/2012 07:46	02/10/2012 04:00	TD

YORK

ANALYTICAL LABORATORIES, INC.

Sample Information

Client Sample ID: **515W18-SB/MW4-GW**

York Sample ID: **12B0219-04**

York Project (SDG) No.
12B0219

Client Project ID
515 West 18th St.

Matrix
Water

Collection Date/Time
February 6, 2012 3:00 pm

Date Received
02/07/2012

Volatile Organics, 8260 List

Log-in Notes:

Sample Notes:

Sample Prepared by Method: EPA 5030B

CAS No.	Parameter	Result	Flag	Units	MDL	RL	Dilution	Reference Method	Date/Time Prepared	Date/Time Analyzed	Analyst
630-20-6	1,1,1,2-Tetrachloroethane	ND		ug/L	0.54	5.0	1	EPA SW846-8260B	02/09/2012 15:14	02/10/2012 05:05	SS
71-55-6	1,1,1-Trichloroethane	ND		ug/L	0.95	5.0	1	EPA SW846-8260B	02/09/2012 15:14	02/10/2012 05:05	SS
79-34-5	1,1,2,2-Tetrachloroethane	ND		ug/L	0.57	5.0	1	EPA SW846-8260B	02/09/2012 15:14	02/10/2012 05:05	SS
76-13-1	1,1,2-Trichloro-1,2,2-trifluoroethane (Freon 113)	ND		ug/L	0.60	5.0	1	EPA SW846-8260B	02/09/2012 15:14	02/10/2012 05:05	SS
79-00-5	1,1,2-Trichloroethane	ND		ug/L	0.61	5.0	1	EPA SW846-8260B	02/09/2012 15:14	02/10/2012 05:05	SS
75-34-3	1,1-Dichloroethane	ND		ug/L	0.69	5.0	1	EPA SW846-8260B	02/09/2012 15:14	02/10/2012 05:05	SS
75-35-4	1,1-Dichloroethylene	ND		ug/L	1.3	5.0	1	EPA SW846-8260B	02/09/2012 15:14	02/10/2012 05:05	SS
563-58-6	1,1-Dichloropropylene	ND		ug/L	0.43	5.0	1	EPA SW846-8260B	02/09/2012 15:14	02/10/2012 05:05	SS
87-61-6	1,2,3-Trichlorobenzene	ND		ug/L	0.37	10	1	EPA SW846-8260B	02/09/2012 15:14	02/10/2012 05:05	SS
96-18-4	1,2,3-Trichloropropane	ND		ug/L	1.1	5.0	1	EPA SW846-8260B	02/09/2012 15:14	02/10/2012 05:05	SS
120-82-1	1,2,4-Trichlorobenzene	ND		ug/L	0.48	10	1	EPA SW846-8260B	02/09/2012 15:14	02/10/2012 05:05	SS
95-63-6	1,2,4-Trimethylbenzene	ND		ug/L	0.53	5.0	1	EPA SW846-8260B	02/09/2012 15:14	02/10/2012 05:05	SS
-8	1,2-Dibromo-3-chloropropane	ND		ug/L	1.3	10	1	EPA SW846-8260B	02/09/2012 15:14	02/10/2012 05:05	SS
106-93-4	1,2-Dibromoethane	ND		ug/L	0.68	5.0	1	EPA SW846-8260B	02/09/2012 15:14	02/10/2012 05:05	SS
95-50-1	1,2-Dichlorobenzene	ND		ug/L	0.59	5.0	1	EPA SW846-8260B	02/09/2012 15:14	02/10/2012 05:05	SS
107-06-2	1,2-Dichloroethane	ND		ug/L	0.65	5.0	1	EPA SW846-8260B	02/09/2012 15:14	02/10/2012 05:05	SS
78-87-5	1,2-Dichloropropane	ND		ug/L	0.22	5.0	1	EPA SW846-8260B	02/09/2012 15:14	02/10/2012 05:05	SS
108-67-8	1,3,5-Trimethylbenzene	ND		ug/L	0.37	5.0	1	EPA SW846-8260B	02/09/2012 15:14	02/10/2012 05:05	SS
541-73-1	1,3-Dichlorobenzene	ND		ug/L	0.47	5.0	1	EPA SW846-8260B	02/09/2012 15:14	02/10/2012 05:05	SS
142-28-9	1,3-Dichloropropane	ND		ug/L	0.69	5.0	1	EPA SW846-8260B	02/09/2012 15:14	02/10/2012 05:05	SS
106-46-7	1,4-Dichlorobenzene	ND		ug/L	0.68	5.0	1	EPA SW846-8260B	02/09/2012 15:14	02/10/2012 05:05	SS
594-20-7	2,2-Dichloropropane	ND		ug/L	0.96	5.0	1	EPA SW846-8260B	02/09/2012 15:14	02/10/2012 05:05	SS
78-93-3	2-Butanone	ND		ug/L	2.6	10	1	EPA SW846-8260B	02/09/2012 15:14	02/10/2012 05:05	SS
95-49-8	2-Chlorotoluene	ND		ug/L	0.49	5.0	1	EPA SW846-8260B	02/09/2012 15:14	02/10/2012 05:05	SS
106-43-4	4-Chlorotoluene	ND		ug/L	0.49	5.0	1	EPA SW846-8260B	02/09/2012 15:14	02/10/2012 05:05	SS
67-64-1	Acetone	ND		ug/L	3.1	10	1	EPA SW846-8260B	02/09/2012 15:14	02/10/2012 05:05	SS
71-43-2	Benzene	83		ug/L	0.48	5.0	1	EPA SW846-8260B	02/09/2012 15:14	02/10/2012 05:05	SS
108-86-1	Bromobenzene	ND		ug/L	0.61	5.0	1	EPA SW846-8260B	02/09/2012 15:14	02/10/2012 05:05	SS
74-97-5	Bromochloromethane	ND		ug/L	1.3	5.0	1	EPA SW846-8260B	02/09/2012 15:14	02/10/2012 05:05	SS
75-27-4	Bromodichloromethane	ND		ug/L	0.62	5.0	1	EPA SW846-8260B	02/09/2012 15:14	02/10/2012 05:05	SS
75-25-2	Bromoform	ND		ug/L	0.58	5.0	1	EPA SW846-8260B	02/09/2012 15:14	02/10/2012 05:05	SS
9	Bromomethane	ND		ug/L	1.2	5.0	1	EPA SW846-8260B	02/09/2012 15:14	02/10/2012 05:05	SS
56-23-5	Carbon tetrachloride	ND		ug/L	1.0	5.0	1	EPA SW846-8260B	02/09/2012 15:14	02/10/2012 05:05	SS
108-90-7	Chlorobenzene	ND		ug/L	0.35	5.0	1	EPA SW846-8260B	02/09/2012 15:14	02/10/2012 05:05	SS

YORK

ANALYTICAL LABORATORIES, INC.

Sample Information

Client Sample ID: 515W18-SB/MW4-GW

York Sample ID: 12B0219-04

York Project (SDG) No.
12B0219

Client Project ID
515 West 18th St.

Matrix
Water

Collection Date/Time
February 6, 2012 3:00 pm

Date Received
02/07/2012

Volatiles Organics, 8260 List

Log-in Notes:

Sample Notes:

Sample Prepared by Method: EPA 5030B

CAS No.	Parameter	Result	Flag	Units	MDL	RL	Dilution	Reference Method	Date/Time Prepared	Date/Time Analyzed	Analyst
75-00-3	Chloroethane	ND		ug/L	0.76	5.0	1	EPA SW846-8260B	02/09/2012 15:14	02/10/2012 05:05	SS
67-66-3	Chloroform	ND		ug/L	0.36	5.0	1	EPA SW846-8260B	02/09/2012 15:14	02/10/2012 05:05	SS
74-87-3	Chloromethane	ND		ug/L	0.89	5.0	1	EPA SW846-8260B	02/09/2012 15:14	02/10/2012 05:05	SS
156-59-2	cis-1,2-Dichloroethylene	ND		ug/L	0.96	5.0	1	EPA SW846-8260B	02/09/2012 15:14	02/10/2012 05:05	SS
10061-01-5	cis-1,3-Dichloropropylene	ND		ug/L	0.35	5.0	1	EPA SW846-8260B	02/09/2012 15:14	02/10/2012 05:05	SS
124-48-1	Dibromochloromethane	ND		ug/L	0.67	5.0	1	EPA SW846-8260B	02/09/2012 15:14	02/10/2012 05:05	SS
74-95-3	Dibromomethane	ND		ug/L	1.3	5.0	1	EPA SW846-8260B	02/09/2012 15:14	02/10/2012 05:05	SS
75-71-8	Dichlorodifluoromethane	ND		ug/L	0.83	5.0	1	EPA SW846-8260B	02/09/2012 15:14	02/10/2012 05:05	SS
100-41-4	Ethyl Benzene	3.4	J	ug/L	0.35	5.0	1	EPA SW846-8260B	02/09/2012 15:14	02/10/2012 05:05	SS
87-68-3	Hexachlorobutadiene	ND		ug/L	0.43	5.0	1	EPA SW846-8260B	02/09/2012 15:14	02/10/2012 05:05	SS
98-82-8	Isopropylbenzene	1.6	J	ug/L	0.39	5.0	1	EPA SW846-8260B	02/09/2012 15:14	02/10/2012 05:05	SS
1634-04-4	Methyl tert-butyl ether (MTBE)	5.6		ug/L	0.38	5.0	1	EPA SW846-8260B	02/09/2012 15:14	02/10/2012 05:05	SS
75-70-2	Methylene chloride	4.3	J, B	ug/L	1.1	10	1	EPA SW846-8260B	02/09/2012 15:14	02/10/2012 05:05	SS
123-05-3	Naphthalene	2.0	J	ug/L	0.50	10	1	EPA SW846-8260B	02/09/2012 15:14	02/10/2012 05:05	SS
104-51-8	n-Butylbenzene	ND		ug/L	0.32	5.0	1	EPA SW846-8260B	02/09/2012 15:14	02/10/2012 05:05	SS
103-65-1	n-Propylbenzene	ND		ug/L	0.58	5.0	1	EPA SW846-8260B	02/09/2012 15:14	02/10/2012 05:05	SS
95-47-6	o-Xylene	1.9	J	ug/L	0.50	5.0	1	EPA SW846-8260B	02/09/2012 15:14	02/10/2012 05:05	SS
1330-20-7P/M	p- & m- Xylenes	2.7	J	ug/L	0.55	10	1	EPA SW846-8260B	02/09/2012 15:14	02/10/2012 05:05	SS
99-87-6	p-Isopropyltoluene	ND		ug/L	0.25	5.0	1	EPA SW846-8260B	02/09/2012 15:14	02/10/2012 05:05	SS
135-98-8	sec-Butylbenzene	ND		ug/L	0.52	5.0	1	EPA SW846-8260B	02/09/2012 15:14	02/10/2012 05:05	SS
100-42-5	Styrene	ND		ug/L	0.43	5.0	1	EPA SW846-8260B	02/09/2012 15:14	02/10/2012 05:05	SS
98-06-6	tert-Butylbenzene	ND		ug/L	0.46	5.0	1	EPA SW846-8260B	02/09/2012 15:14	02/10/2012 05:05	SS
127-18-4	Tetrachloroethylene	ND		ug/L	0.52	5.0	1	EPA SW846-8260B	02/09/2012 15:14	02/10/2012 05:05	SS
108-88-3	Toluene	ND		ug/L	0.23	5.0	1	EPA SW846-8260B	02/09/2012 15:14	02/10/2012 05:05	SS
156-60-5	trans-1,2-Dichloroethylene	ND		ug/L	0.65	5.0	1	EPA SW846-8260B	02/09/2012 15:14	02/10/2012 05:05	SS
10061-02-6	trans-1,3-Dichloropropylene	ND		ug/L	0.68	5.0	1	EPA SW846-8260B	02/09/2012 15:14	02/10/2012 05:05	SS
79-01-6	Trichloroethylene	ND		ug/L	0.57	5.0	1	EPA SW846-8260B	02/09/2012 15:14	02/10/2012 05:05	SS
75-69-4	Trichlorofluoromethane	ND		ug/L	0.91	5.0	1	EPA SW846-8260B	02/09/2012 15:14	02/10/2012 05:05	SS
75-01-4	Vinyl Chloride	ND		ug/L	0.97	5.0	1	EPA SW846-8260B	02/09/2012 15:14	02/10/2012 05:05	SS
1330-20-7	Xylenes, Total	4.7	J	ug/L	1.0	15	1	EPA SW846-8260B	02/09/2012 15:14	02/10/2012 05:05	SS

YORK

ANALYTICAL LABORATORIES, INC.

Sample Information

Client Sample ID: 515W18-SB/MW4-GW

York Sample ID: 12B0219-04

York Project (SDG) No.
12B0219

Client Project ID
515 West 18th St.

Matrix
Water

Collection Date/Time
February 6, 2012 3:00 pm

Date Received
02/07/2012

Semi-Volatiles, 8270 Target List

Log-in Notes:

Sample Notes:

Sample Prepared by Method: EPA 3510C

CAS No.	Parameter	Result	Flag	Units	MDL	RL	Dilution	Reference Method	Date/Time Prepared	Date/Time Analyzed	Analyst
120-82-1	1,2,4-Trichlorobenzene	ND		ug/L	1.31	5.00	1	EPA SW-846 8270C	02/08/2012 07:46	02/08/2012 23:17	TD
95-50-1	1,2-Dichlorobenzene	ND		ug/L	1.64	5.00	1	EPA SW-846 8270C	02/08/2012 07:46	02/08/2012 23:17	TD
541-73-1	1,3-Dichlorobenzene	ND		ug/L	2.75	5.00	1	EPA SW-846 8270C	02/08/2012 07:46	02/08/2012 23:17	TD
106-46-7	1,4-Dichlorobenzene	ND		ug/L	3.23	5.00	1	EPA SW-846 8270C	02/08/2012 07:46	02/08/2012 23:17	TD
95-95-4	2,4,5-Trichlorophenol	ND		ug/L	3.61	5.00	1	EPA SW-846 8270C	02/08/2012 07:46	02/08/2012 23:17	TD
88-06-2	2,4,6-Trichlorophenol	ND		ug/L	3.27	5.00	1	EPA SW-846 8270C	02/08/2012 07:46	02/08/2012 23:17	TD
120-83-2	2,4-Dichlorophenol	ND		ug/L	3.09	5.00	1	EPA SW-846 8270C	02/08/2012 07:46	02/08/2012 23:17	TD
105-67-9	2,4-Dimethylphenol	ND		ug/L	3.68	5.00	1	EPA SW-846 8270C	02/08/2012 07:46	02/08/2012 23:17	TD
51-28-5	2,4-Dinitrophenol	ND		ug/L	9.60	10.0	1	EPA SW-846 8270C	02/08/2012 07:46	02/08/2012 23:17	TD
121-14-2	2,4-Dinitrotoluene	ND		ug/L	2.37	5.00	1	EPA SW-846 8270C	02/08/2012 07:46	02/08/2012 23:17	TD
606-20-2	2,6-Dinitrotoluene	ND		ug/L	3.51	5.00	1	EPA SW-846 8270C	02/08/2012 07:46	02/08/2012 23:17	TD
91-58-7	2-Chloronaphthalene	ND		ug/L	3.49	5.00	1	EPA SW-846 8270C	02/08/2012 07:46	02/08/2012 23:17	TD
7-8	2-Chlorophenol	ND		ug/L	3.42	5.00	1	EPA SW-846 8270C	02/08/2012 07:46	02/08/2012 23:17	TD
91-57-6	2-Methylnaphthalene	ND		ug/L	3.07	5.00	1	EPA SW-846 8270C	02/08/2012 07:46	02/08/2012 23:17	TD
95-48-7	2-Methylphenol	ND		ug/L	0.857	5.00	1	EPA SW-846 8270C	02/08/2012 07:46	02/08/2012 23:17	TD
88-74-4	2-Nitroaniline	ND		ug/L	3.01	5.00	1	EPA SW-846 8270C	02/08/2012 07:46	02/08/2012 23:17	TD
88-75-5	2-Nitrophenol	ND		ug/L	3.10	5.00	1	EPA SW-846 8270C	02/08/2012 07:46	02/08/2012 23:17	TD
100-01-6	3- & 4-Methylphenols	ND		ug/L	3.72	5.00	1	EPA SW-846 8270C	02/08/2012 07:46	02/08/2012 23:17	TD
91-94-1	3,3'-Dichlorobenzidine	ND		ug/L	3.51	5.00	1	EPA SW-846 8270C	02/08/2012 07:46	02/08/2012 23:17	TD
99-09-2	3-Nitroaniline	ND		ug/L	1.59	5.00	1	EPA SW-846 8270C	02/08/2012 07:46	02/08/2012 23:17	TD
534-52-1	4,6-Dinitro-2-methylphenol	ND		ug/L	6.70	10.0	1	EPA SW-846 8270C	02/08/2012 07:46	02/08/2012 23:17	TD
101-55-3	4-Bromophenyl phenyl ether	ND		ug/L	3.45	5.00	1	EPA SW-846 8270C	02/08/2012 07:46	02/08/2012 23:17	TD
59-50-7	4-Chloro-3-methylphenol	ND		ug/L	3.63	5.00	1	EPA SW-846 8270C	02/08/2012 07:46	02/08/2012 23:17	TD
106-47-8	4-Chloroaniline	ND		ug/L	3.74	5.00	1	EPA SW-846 8270C	02/08/2012 07:46	02/08/2012 23:17	TD
7005-72-3	4-Chlorophenyl phenyl ether	ND		ug/L	3.12	5.00	1	EPA SW-846 8270C	02/08/2012 07:46	02/08/2012 23:17	TD
100-02-7	4-Nitroaniline	ND		ug/L	3.77	5.00	1	EPA SW-846 8270C	02/08/2012 07:46	02/08/2012 23:17	TD
56-57-5	4-Nitrophenol	ND		ug/L	3.94	5.00	1	EPA SW-846 8270C	02/08/2012 07:46	02/08/2012 23:17	TD
83-32-9	Acenaphthene	ND		ug/L	3.24	5.00	1	EPA SW-846 8270C	02/08/2012 07:46	02/08/2012 23:17	TD
208-96-8	Acenaphthylene	ND		ug/L	4.27	5.00	1	EPA SW-846 8270C	02/08/2012 07:46	02/08/2012 23:17	TD
62-53-3	Aniline	ND		ug/L	1.97	5.00	1	EPA SW-846 8270C	02/08/2012 07:46	02/08/2012 23:17	TD
120-12-7	Anthracene	ND		ug/L	3.66	5.00	1	EPA SW-846 8270C	02/08/2012 07:46	02/08/2012 23:17	TD
15-3	Benzo(a)anthracene	ND		ug/L	4.07	5.00	1	EPA SW-846 8270C	02/08/2012 07:46	02/08/2012 23:17	TD
50-32-8	Benzo(a)pyrene	ND		ug/L	4.85	5.00	1	EPA SW-846 8270C	02/08/2012 07:46	02/08/2012 23:17	TD
205-99-2	Benzo(b)fluoranthene	ND		ug/L	4.12	5.00	1	EPA SW-846 8270C	02/08/2012 07:46	02/08/2012 23:17	TD
191-24-2	Benzo(g,h,i)perylene	ND		ug/L	4.15	5.00	1	EPA SW-846 8270C	02/08/2012 07:46	02/08/2012 23:17	TD

YORK

ANALYTICAL LABORATORIES, INC.

Sample Information

Client Sample ID: 515W18-SB/MW4-GW

York Sample ID: 12B0219-04

York Project (SDG) No.
12B0219

Client Project ID
515 West 18th St.

Matrix
Water

Collection Date/Time
February 6, 2012 3:00 pm

Date Received
02/07/2012

Semi-Volatiles, 8270 Target List

Log-in Notes:

Sample Notes:

Sample Prepared by Method: EPA 3510C

CAS No.	Parameter	Result	Flag	Units	MDL	RL	Dilution	Reference Method	Date/Time Prepared	Date/Time Analyzed	Analyst
207-08-9	Benzo(k)fluoranthene	ND		ug/L	3.46	5.00	1	EPA SW-846 8270C	02/08/2012 07:46	02/08/2012 23:17	TD
100-51-6	Benzyl alcohol	ND		ug/L	4.00	5.00	1	EPA SW-846 8270C	02/08/2012 07:46	02/08/2012 23:17	TD
85-68-7	Benzyl butyl phthalate	ND		ug/L	2.30	5.00	1	EPA SW-846 8270C	02/08/2012 07:46	02/08/2012 23:17	TD
111-91-1	Bis(2-chloroethoxy)methane	ND		ug/L	4.85	5.00	1	EPA SW-846 8270C	02/08/2012 07:46	02/08/2012 23:17	TD
111-44-4	Bis(2-chloroethyl)ether	ND		ug/L	4.12	5.00	1	EPA SW-846 8270C	02/08/2012 07:46	02/08/2012 23:17	TD
108-60-1	Bis(2-chloroisopropyl)ether	ND		ug/L	4.15	5.00	1	EPA SW-846 8270C	02/08/2012 07:46	02/08/2012 23:17	TD
117-81-7	Bis(2-ethylhexyl)phthalate	ND		ug/L	2.57	5.00	1	EPA SW-846 8270C	02/08/2012 07:46	02/08/2012 23:17	TD
218-01-9	Chrysene	ND		ug/L	4.15	5.00	1	EPA SW-846 8270C	02/08/2012 07:46	02/08/2012 23:17	TD
53-70-3	Dibenzo(a,h)anthracene	ND		ug/L	3.10	5.00	1	EPA SW-846 8270C	02/08/2012 07:46	02/08/2012 23:17	TD
132-64-9	Dibenzofuran	ND		ug/L	2.90	5.00	1	EPA SW-846 8270C	02/08/2012 07:46	02/08/2012 23:17	TD
84-66-2	Diethyl phthalate	ND		ug/L	2.20	5.00	1	EPA SW-846 8270C	02/08/2012 07:46	02/08/2012 23:17	TD
131-11-3	Dimethyl phthalate	ND		ug/L	4.85	5.00	1	EPA SW-846 8270C	02/08/2012 07:46	02/08/2012 23:17	TD
2	Di-n-butyl phthalate	ND		ug/L	4.12	5.00	1	EPA SW-846 8270C	02/08/2012 07:46	02/08/2012 23:17	TD
117-84-0	Di-n-octyl phthalate	ND		ug/L	4.15	5.00	1	EPA SW-846 8270C	02/08/2012 07:46	02/08/2012 23:17	TD
206-44-0	Fluoranthene	ND		ug/L	1.59	5.00	1	EPA SW-846 8270C	02/08/2012 07:46	02/08/2012 23:17	TD
86-73-7	Fluorene	ND		ug/L	3.22	5.00	1	EPA SW-846 8270C	02/08/2012 07:46	02/08/2012 23:17	TD
118-74-1	Hexachlorobenzene	ND		ug/L	2.96	5.00	1	EPA SW-846 8270C	02/08/2012 07:46	02/08/2012 23:17	TD
87-68-3	Hexachlorobutadiene	ND		ug/L	3.31	5.00	1	EPA SW-846 8270C	02/08/2012 07:46	02/08/2012 23:17	TD
77-47-4	Hexachlorocyclopentadiene	ND		ug/L	3.45	5.00	1	EPA SW-846 8270C	02/08/2012 07:46	02/08/2012 23:17	TD
67-72-1	Hexachloroethane	ND		ug/L	3.63	5.00	1	EPA SW-846 8270C	02/08/2012 07:46	02/08/2012 23:17	TD
193-39-5	Indeno(1,2,3-cd)pyrene	ND		ug/L	2.75	5.00	1	EPA SW-846 8270C	02/08/2012 07:46	02/08/2012 23:17	TD
78-59-1	Isophorone	ND		ug/L	3.23	5.00	1	EPA SW-846 8270C	02/08/2012 07:46	02/08/2012 23:17	TD
91-20-3	Naphthalene	ND		ug/L	3.86	5.00	1	EPA SW-846 8270C	02/08/2012 07:46	02/08/2012 23:17	TD
98-95-3	Nitrobenzene	ND		ug/L	1.97	5.00	1	EPA SW-846 8270C	02/08/2012 07:46	02/08/2012 23:17	TD
62-75-9	N-Nitrosodimethylamine	ND		ug/L	3.10	5.00	1	EPA SW-846 8270C	02/08/2012 07:46	02/08/2012 23:17	TD
621-64-7	N-nitroso-di-n-propylamine	ND		ug/L	2.57	5.00	1	EPA SW-846 8270C	02/08/2012 07:46	02/08/2012 23:17	TD
86-30-6	N-Nitrosodiphenylamine	ND		ug/L	3.62	5.00	1	EPA SW-846 8270C	02/08/2012 07:46	02/08/2012 23:17	TD
87-86-5	Pentachlorophenol	ND		ug/L	3.76	5.00	1	EPA SW-846 8270C	02/08/2012 07:46	02/08/2012 23:17	TD
85-01-8	Phenanthrene	ND		ug/L	3.61	5.00	1	EPA SW-846 8270C	02/08/2012 07:46	02/08/2012 23:17	TD
108-95-2	Phenol	ND		ug/L	3.27	5.00	1	EPA SW-846 8270C	02/08/2012 07:46	02/08/2012 23:17	TD
129-00-0	Pyrene	ND		ug/L	2.37	5.00	1	EPA SW-846 8270C	02/08/2012 07:46	02/08/2012 23:17	TD
16-1	Pyridine	ND		ug/L	3.19	5.00	1	EPA SW-846 8270C	02/08/2012 07:46	02/08/2012 23:17	TD

YORK

ANALYTICAL LABORATORIES, INC.

Sample Information

Client Sample ID: 515W18-SB/MW5-GW

York Sample ID: 12B0219-05

York Project (SDG) No.
12B0219

Client Project ID
515 West 18th St.

Matrix
Water

Collection Date/Time
February 6, 2012 3:00 pm

Date Received
02/07/2012

Volatiles Organics, 8260 List

Log-in Notes:

Sample Notes:

Sample Prepared by Method: EPA 5030B

CAS No.	Parameter	Result	Flag	Units	MDL	RL	Dilution	Reference Method	Date/Time Prepared	Date/Time Analyzed	Analyst
630-20-6	1,1,1,2-Tetrachloroethane	ND		ug/L	0.54	5.0	1	EPA SW846-8260B	02/09/2012 15:14	02/11/2012 21:38	SS
71-55-6	1,1,1-Trichloroethane	ND		ug/L	0.95	5.0	1	EPA SW846-8260B	02/09/2012 15:14	02/11/2012 21:38	SS
79-34-5	1,1,2,2-Tetrachloroethane	ND		ug/L	0.57	5.0	1	EPA SW846-8260B	02/09/2012 15:14	02/11/2012 21:38	SS
76-13-1	1,1,2-Trichloro-1,2,2-trifluoroethane (Freon 113)	ND		ug/L	0.60	5.0	1	EPA SW846-8260B	02/09/2012 15:14	02/11/2012 21:38	SS
79-00-5	1,1,2-Trichloroethane	ND		ug/L	0.61	5.0	1	EPA SW846-8260B	02/09/2012 15:14	02/11/2012 21:38	SS
75-34-3	1,1-Dichloroethane	ND		ug/L	0.69	5.0	1	EPA SW846-8260B	02/09/2012 15:14	02/11/2012 21:38	SS
75-35-4	1,1-Dichloroethylene	ND		ug/L	1.3	5.0	1	EPA SW846-8260B	02/09/2012 15:14	02/11/2012 21:38	SS
563-58-6	1,1-Dichloropropylene	ND		ug/L	0.43	5.0	1	EPA SW846-8260B	02/09/2012 15:14	02/11/2012 21:38	SS
87-61-6	1,2,3-Trichlorobenzene	ND		ug/L	0.37	10	1	EPA SW846-8260B	02/09/2012 15:14	02/11/2012 21:38	SS
96-18-4	1,2,3-Trichloropropane	ND		ug/L	1.1	5.0	1	EPA SW846-8260B	02/09/2012 15:14	02/11/2012 21:38	SS
120-82-1	1,2,4-Trichlorobenzene	ND		ug/L	0.48	10	1	EPA SW846-8260B	02/09/2012 15:14	02/11/2012 21:38	SS
95-63-6	1,2,4-Trimethylbenzene	ND		ug/L	0.53	5.0	1	EPA SW846-8260B	02/09/2012 15:14	02/11/2012 21:38	SS
2-8	1,2-Dibromo-3-chloropropane	ND		ug/L	1.3	10	1	EPA SW846-8260B	02/09/2012 15:14	02/11/2012 21:38	SS
106-93-4	1,2-Dibromoethane	ND		ug/L	0.68	5.0	1	EPA SW846-8260B	02/09/2012 15:14	02/11/2012 21:38	SS
95-50-1	1,2-Dichlorobenzene	ND		ug/L	0.59	5.0	1	EPA SW846-8260B	02/09/2012 15:14	02/11/2012 21:38	SS
107-06-2	1,2-Dichloroethane	ND		ug/L	0.65	5.0	1	EPA SW846-8260B	02/09/2012 15:14	02/11/2012 21:38	SS
78-87-5	1,2-Dichloropropane	ND		ug/L	0.22	5.0	1	EPA SW846-8260B	02/09/2012 15:14	02/11/2012 21:38	SS
108-67-8	1,3,5-Trimethylbenzene	ND		ug/L	0.37	5.0	1	EPA SW846-8260B	02/09/2012 15:14	02/11/2012 21:38	SS
541-73-1	1,3-Dichlorobenzene	ND		ug/L	0.47	5.0	1	EPA SW846-8260B	02/09/2012 15:14	02/11/2012 21:38	SS
142-28-9	1,3-Dichloropropane	ND		ug/L	0.69	5.0	1	EPA SW846-8260B	02/09/2012 15:14	02/11/2012 21:38	SS
106-46-7	1,4-Dichlorobenzene	ND		ug/L	0.68	5.0	1	EPA SW846-8260B	02/09/2012 15:14	02/11/2012 21:38	SS
594-20-7	2,2-Dichloropropane	ND		ug/L	0.96	5.0	1	EPA SW846-8260B	02/09/2012 15:14	02/11/2012 21:38	SS
78-93-3	2-Butanone	ND		ug/L	2.6	10	1	EPA SW846-8260B	02/09/2012 15:14	02/11/2012 21:38	SS
95-49-8	2-Chlorotoluene	ND		ug/L	0.49	5.0	1	EPA SW846-8260B	02/09/2012 15:14	02/11/2012 21:38	SS
106-43-4	4-Chlorotoluene	ND		ug/L	0.49	5.0	1	EPA SW846-8260B	02/09/2012 15:14	02/11/2012 21:38	SS
67-64-1	Acetone	ND		ug/L	3.1	10	1	EPA SW846-8260B	02/09/2012 15:14	02/11/2012 21:38	SS
71-43-2	Benzene	30		ug/L	0.48	5.0	1	EPA SW846-8260B	02/09/2012 15:14	02/11/2012 21:38	SS
108-86-1	Bromobenzene	ND		ug/L	0.61	5.0	1	EPA SW846-8260B	02/09/2012 15:14	02/11/2012 21:38	SS
74-97-5	Bromochloromethane	ND		ug/L	1.3	5.0	1	EPA SW846-8260B	02/09/2012 15:14	02/11/2012 21:38	SS
75-27-4	Bromodichloromethane	ND		ug/L	0.62	5.0	1	EPA SW846-8260B	02/09/2012 15:14	02/11/2012 21:38	SS
75-25-2	Bromoform	ND		ug/L	0.58	5.0	1	EPA SW846-8260B	02/09/2012 15:14	02/11/2012 21:38	SS
3-9	Bromomethane	ND		ug/L	1.2	5.0	1	EPA SW846-8260B	02/09/2012 15:14	02/11/2012 21:38	SS
56-23-5	Carbon tetrachloride	ND		ug/L	1.0	5.0	1	EPA SW846-8260B	02/09/2012 15:14	02/11/2012 21:38	SS
108-90-7	Chlorobenzene	ND		ug/L	0.35	5.0	1	EPA SW846-8260B	02/09/2012 15:14	02/11/2012 21:38	SS

YORK

ANALYTICAL LABORATORIES, INC.

Sample Information

Client Sample ID: 515W18-SB/MW5-GW

York Sample ID: 12B0219-05

York Project (SDG) No.
12B0219

Client Project ID
515 West 18th St.

Matrix
Water

Collection Date/Time
February 6, 2012 3:00 pm

Date Received
02/07/2012

Volatile Organics, 8260 List

Log-in Notes:

Sample Notes:

Sample Prepared by Method: EPA 5030B

CAS No.	Parameter	Result	Flag	Units	MDL	RL	Dilution	Reference Method	Date/Time Prepared	Date/Time Analyzed	Analyst
75-00-3	Chloroethane	ND		ug/L	0.76	5.0	1	EPA SW846-8260B	02/09/2012 15:14	02/11/2012 21:38	SS
67-66-3	Chloroform	ND		ug/L	0.36	5.0	1	EPA SW846-8260B	02/09/2012 15:14	02/11/2012 21:38	SS
74-87-3	Chloromethane	ND		ug/L	0.89	5.0	1	EPA SW846-8260B	02/09/2012 15:14	02/11/2012 21:38	SS
156-59-2	cis-1,2-Dichloroethylene	ND		ug/L	0.96	5.0	1	EPA SW846-8260B	02/09/2012 15:14	02/11/2012 21:38	SS
10061-01-5	cis-1,3-Dichloropropylene	ND		ug/L	0.35	5.0	1	EPA SW846-8260B	02/09/2012 15:14	02/11/2012 21:38	SS
124-48-1	Dibromochloromethane	ND		ug/L	0.67	5.0	1	EPA SW846-8260B	02/09/2012 15:14	02/11/2012 21:38	SS
74-95-3	Dibromomethane	ND		ug/L	1.3	5.0	1	EPA SW846-8260B	02/09/2012 15:14	02/11/2012 21:38	SS
75-71-8	Dichlorodifluoromethane	ND		ug/L	0.83	5.0	1	EPA SW846-8260B	02/09/2012 15:14	02/11/2012 21:38	SS
100-41-4	Ethyl Benzene	2.5	J	ug/L	0.35	5.0	1	EPA SW846-8260B	02/09/2012 15:14	02/11/2012 21:38	SS
87-68-3	Hexachlorobutadiene	ND		ug/L	0.43	5.0	1	EPA SW846-8260B	02/09/2012 15:14	02/11/2012 21:38	SS
98-82-8	Isopropylbenzene	6.1		ug/L	0.39	5.0	1	EPA SW846-8260B	02/09/2012 15:14	02/11/2012 21:38	SS
1634-04-4	Methyl tert-butyl ether (MTBE)	3.6	J	ug/L	0.38	5.0	1	EPA SW846-8260B	02/09/2012 15:14	02/11/2012 21:38	SS
75-09-2	Methylene chloride	3.5	J, B	ug/L	1.1	10	1	EPA SW846-8260B	02/09/2012 15:14	02/11/2012 21:38	SS
124-03-3	Naphthalene	1.4	J	ug/L	0.50	10	1	EPA SW846-8260B	02/09/2012 15:14	02/11/2012 21:38	SS
104-51-8	n-Butylbenzene	1.6	J	ug/L	0.32	5.0	1	EPA SW846-8260B	02/09/2012 15:14	02/11/2012 21:38	SS
103-65-1	n-Propylbenzene	6.3		ug/L	0.58	5.0	1	EPA SW846-8260B	02/09/2012 15:14	02/11/2012 21:38	SS
95-47-6	o-Xylene	1.6	J	ug/L	0.50	5.0	1	EPA SW846-8260B	02/09/2012 15:14	02/11/2012 21:38	SS
1330-20-7P/M	p- & m- Xylenes	1.6	J	ug/L	0.55	10	1	EPA SW846-8260B	02/09/2012 15:14	02/11/2012 21:38	SS
99-87-6	p-Isopropyltoluene	ND		ug/L	0.25	5.0	1	EPA SW846-8260B	02/09/2012 15:14	02/11/2012 21:38	SS
135-98-8	sec-Butylbenzene	1.8	J	ug/L	0.52	5.0	1	EPA SW846-8260B	02/09/2012 15:14	02/11/2012 21:38	SS
100-42-5	Styrene	ND		ug/L	0.43	5.0	1	EPA SW846-8260B	02/09/2012 15:14	02/11/2012 21:38	SS
98-06-6	tert-Butylbenzene	ND		ug/L	0.46	5.0	1	EPA SW846-8260B	02/09/2012 15:14	02/11/2012 21:38	SS
127-18-4	Tetrachloroethylene	ND		ug/L	0.52	5.0	1	EPA SW846-8260B	02/09/2012 15:14	02/11/2012 21:38	SS
108-88-3	Toluene	ND		ug/L	0.23	5.0	1	EPA SW846-8260B	02/09/2012 15:14	02/11/2012 21:38	SS
156-60-5	trans-1,2-Dichloroethylene	ND		ug/L	0.65	5.0	1	EPA SW846-8260B	02/09/2012 15:14	02/11/2012 21:38	SS
10061-02-6	trans-1,3-Dichloropropylene	ND		ug/L	0.68	5.0	1	EPA SW846-8260B	02/09/2012 15:14	02/11/2012 21:38	SS
79-01-6	Trichloroethylene	ND		ug/L	0.57	5.0	1	EPA SW846-8260B	02/09/2012 15:14	02/11/2012 21:38	SS
75-69-4	Trichlorofluoromethane	ND		ug/L	0.91	5.0	1	EPA SW846-8260B	02/09/2012 15:14	02/11/2012 21:38	SS
75-01-4	Vinyl Chloride	ND		ug/L	0.97	5.0	1	EPA SW846-8260B	02/09/2012 15:14	02/11/2012 21:38	SS
1330-20-7	Xylenes, Total	3.2	J	ug/L	1.0	15	1	EPA SW846-8260B	02/09/2012 15:14	02/11/2012 21:38	SS

YORK

ANALYTICAL LABORATORIES, INC.

Sample Information

Client Sample ID: 515W18-SB/MW5-GW

York Sample ID: 12B0219-05

York Project (SDG) No.
12B0219

Client Project ID
515 West 18th St.

Matrix
Water

Collection Date/Time
February 6, 2012 3:00 pm

Date Received
02/07/2012

Semi-Volatiles, 8270 Target List

Sample Prepared by Method: EPA 3510C

Log-in Notes:

Sample Notes:

CAS No.	Parameter	Result	Flag	Units	MDL	RL	Dilution	Reference Method	Date/Time Prepared	Date/Time Analyzed	Analyst
120-82-1	1,2,4-Trichlorobenzene	ND		ug/L	1.31	5.00	1	EPA SW-846 8270C	02/08/2012 07:46	02/08/2012 23:49	TD
95-50-1	1,2-Dichlorobenzene	ND		ug/L	1.64	5.00	1	EPA SW-846 8270C	02/08/2012 07:46	02/08/2012 23:49	TD
541-73-1	1,3-Dichlorobenzene	ND		ug/L	2.75	5.00	1	EPA SW-846 8270C	02/08/2012 07:46	02/08/2012 23:49	TD
106-46-7	1,4-Dichlorobenzene	ND		ug/L	3.23	5.00	1	EPA SW-846 8270C	02/08/2012 07:46	02/08/2012 23:49	TD
95-95-4	2,4,5-Trichlorophenol	ND		ug/L	3.61	5.00	1	EPA SW-846 8270C	02/08/2012 07:46	02/08/2012 23:49	TD
88-06-2	2,4,6-Trichlorophenol	ND		ug/L	3.27	5.00	1	EPA SW-846 8270C	02/08/2012 07:46	02/08/2012 23:49	TD
120-83-2	2,4-Dichlorophenol	ND		ug/L	3.09	5.00	1	EPA SW-846 8270C	02/08/2012 07:46	02/08/2012 23:49	TD
105-67-9	2,4-Dimethylphenol	ND		ug/L	3.68	5.00	1	EPA SW-846 8270C	02/08/2012 07:46	02/08/2012 23:49	TD
51-28-5	2,4-Dinitrophenol	ND		ug/L	9.60	10.0	1	EPA SW-846 8270C	02/08/2012 07:46	02/08/2012 23:49	TD
121-14-2	2,4-Dinitrotoluene	ND		ug/L	2.37	5.00	1	EPA SW-846 8270C	02/08/2012 07:46	02/08/2012 23:49	TD
606-20-2	2,6-Dinitrotoluene	ND		ug/L	3.51	5.00	1	EPA SW-846 8270C	02/08/2012 07:46	02/08/2012 23:49	TD
91-58-7	2-Chloronaphthalene	ND		ug/L	3.49	5.00	1	EPA SW-846 8270C	02/08/2012 07:46	02/08/2012 23:49	TD
57-8	2-Chlorophenol	ND		ug/L	3.42	5.00	1	EPA SW-846 8270C	02/08/2012 07:46	02/08/2012 23:49	TD
91-57-6	2-Methylnaphthalene	ND		ug/L	3.07	5.00	1	EPA SW-846 8270C	02/08/2012 07:46	02/08/2012 23:49	TD
95-48-7	2-Methylphenol	ND		ug/L	0.857	5.00	1	EPA SW-846 8270C	02/08/2012 07:46	02/08/2012 23:49	TD
88-74-4	2-Nitroaniline	ND		ug/L	3.01	5.00	1	EPA SW-846 8270C	02/08/2012 07:46	02/08/2012 23:49	TD
88-75-5	2-Nitrophenol	ND		ug/L	3.10	5.00	1	EPA SW-846 8270C	02/08/2012 07:46	02/08/2012 23:49	TD
100-01-6	3- & 4-Methylphenols	ND		ug/L	3.72	5.00	1	EPA SW-846 8270C	02/08/2012 07:46	02/08/2012 23:49	TD
91-94-1	3,3'-Dichlorobenzidine	ND		ug/L	3.51	5.00	1	EPA SW-846 8270C	02/08/2012 07:46	02/08/2012 23:49	TD
99-09-2	3-Nitroaniline	ND		ug/L	1.59	5.00	1	EPA SW-846 8270C	02/08/2012 07:46	02/08/2012 23:49	TD
534-52-1	4,6-Dinitro-2-methylphenol	ND		ug/L	6.70	10.0	1	EPA SW-846 8270C	02/08/2012 07:46	02/08/2012 23:49	TD
101-55-3	4-Bromophenyl phenyl ether	ND		ug/L	3.45	5.00	1	EPA SW-846 8270C	02/08/2012 07:46	02/08/2012 23:49	TD
59-50-7	4-Chloro-3-methylphenol	ND		ug/L	3.63	5.00	1	EPA SW-846 8270C	02/08/2012 07:46	02/08/2012 23:49	TD
106-47-8	4-Chloroaniline	ND		ug/L	3.74	5.00	1	EPA SW-846 8270C	02/08/2012 07:46	02/08/2012 23:49	TD
7005-72-3	4-Chlorophenyl phenyl ether	ND		ug/L	3.12	5.00	1	EPA SW-846 8270C	02/08/2012 07:46	02/08/2012 23:49	TD
100-02-7	4-Nitroaniline	ND		ug/L	3.77	5.00	1	EPA SW-846 8270C	02/08/2012 07:46	02/08/2012 23:49	TD
56-57-5	4-Nitrophenol	ND		ug/L	3.94	5.00	1	EPA SW-846 8270C	02/08/2012 07:46	02/08/2012 23:49	TD
83-32-9	Acenaphthene	ND		ug/L	3.24	5.00	1	EPA SW-846 8270C	02/08/2012 07:46	02/08/2012 23:49	TD
208-96-8	Acenaphthylene	ND		ug/L	4.27	5.00	1	EPA SW-846 8270C	02/08/2012 07:46	02/08/2012 23:49	TD
62-53-3	Aniline	ND		ug/L	1.97	5.00	1	EPA SW-846 8270C	02/08/2012 07:46	02/08/2012 23:49	TD
120-12-7	Anthracene	ND		ug/L	3.66	5.00	1	EPA SW-846 8270C	02/08/2012 07:46	02/08/2012 23:49	TD
55-3	Benzo(a)anthracene	ND		ug/L	4.07	5.00	1	EPA SW-846 8270C	02/08/2012 07:46	02/08/2012 23:49	TD
120-32-8	Benzo(a)pyrene	ND		ug/L	4.85	5.00	1	EPA SW-846 8270C	02/08/2012 07:46	02/08/2012 23:49	TD
205-99-2	Benzo(b)fluoranthene	ND		ug/L	4.12	5.00	1	EPA SW-846 8270C	02/08/2012 07:46	02/08/2012 23:49	TD
191-24-2	Benzo(g,h,i)perylene	ND		ug/L	4.15	5.00	1	EPA SW-846 8270C	02/08/2012 07:46	02/08/2012 23:49	TD

YORK

ANALYTICAL LABORATORIES, INC.

Sample Information

Client Sample ID: 515W18-SB/MW5-GW

York Sample ID: 12B0219-05

York Project (SDG) No.
12B0219

Client Project ID
515 West 18th St.

Matrix
Water

Collection Date/Time
February 6, 2012 3:00 pm

Date Received
02/07/2012

Semi-Volatiles, 8270 Target List

Log-in Notes:

Sample Notes:

Sample Prepared by Method: EPA 3510C

CAS No.	Parameter	Result	Flag	Units	MDL	RL	Dilution	Reference Method	Date/Time Prepared	Date/Time Analyzed	Analyst
207-08-9	Benzo(k)fluoranthene	ND		ug/L	3.46	5.00	1	EPA SW-846 8270C	02/08/2012 07:46	02/08/2012 23:49	TD
100-51-6	Benzyl alcohol	ND		ug/L	4.00	5.00	1	EPA SW-846 8270C	02/08/2012 07:46	02/08/2012 23:49	TD
85-68-7	Benzyl butyl phthalate	ND		ug/L	2.30	5.00	1	EPA SW-846 8270C	02/08/2012 07:46	02/08/2012 23:49	TD
111-91-1	Bis(2-chloroethoxy)methane	ND		ug/L	4.85	5.00	1	EPA SW-846 8270C	02/08/2012 07:46	02/08/2012 23:49	TD
111-44-4	Bis(2-chloroethyl)ether	ND		ug/L	4.12	5.00	1	EPA SW-846 8270C	02/08/2012 07:46	02/08/2012 23:49	TD
108-60-1	Bis(2-chloroisopropyl)ether	ND		ug/L	4.15	5.00	1	EPA SW-846 8270C	02/08/2012 07:46	02/08/2012 23:49	TD
117-81-7	Bis(2-ethylhexyl)phthalate	58.2		ug/L	2.57	5.00	1	EPA SW-846 8270C	02/08/2012 07:46	02/08/2012 23:49	TD
218-01-9	Chrysene	ND		ug/L	4.15	5.00	1	EPA SW-846 8270C	02/08/2012 07:46	02/08/2012 23:49	TD
53-70-3	Dibenzo(a,h)anthracene	ND		ug/L	3.10	5.00	1	EPA SW-846 8270C	02/08/2012 07:46	02/08/2012 23:49	TD
132-64-9	Dibenzofuran	ND		ug/L	2.90	5.00	1	EPA SW-846 8270C	02/08/2012 07:46	02/08/2012 23:49	TD
84-66-2	Diethyl phthalate	ND		ug/L	2.20	5.00	1	EPA SW-846 8270C	02/08/2012 07:46	02/08/2012 23:49	TD
131-11-3	Dimethyl phthalate	ND		ug/L	4.85	5.00	1	EPA SW-846 8270C	02/08/2012 07:46	02/08/2012 23:49	TD
117-84-0	Di-n-butyl phthalate	ND		ug/L	4.12	5.00	1	EPA SW-846 8270C	02/08/2012 07:46	02/08/2012 23:49	TD
117-84-0	Di-n-octyl phthalate	ND		ug/L	4.15	5.00	1	EPA SW-846 8270C	02/08/2012 07:46	02/08/2012 23:49	TD
206-44-0	Fluoranthene	ND		ug/L	1.59	5.00	1	EPA SW-846 8270C	02/08/2012 07:46	02/08/2012 23:49	TD
86-73-7	Fluorene	ND		ug/L	3.22	5.00	1	EPA SW-846 8270C	02/08/2012 07:46	02/08/2012 23:49	TD
118-74-1	Hexachlorobenzene	ND		ug/L	2.96	5.00	1	EPA SW-846 8270C	02/08/2012 07:46	02/08/2012 23:49	TD
87-68-3	Hexachlorobutadiene	ND		ug/L	3.31	5.00	1	EPA SW-846 8270C	02/08/2012 07:46	02/08/2012 23:49	TD
77-47-4	Hexachlorocyclopentadiene	ND		ug/L	3.45	5.00	1	EPA SW-846 8270C	02/08/2012 07:46	02/08/2012 23:49	TD
67-72-1	Hexachloroethane	ND		ug/L	3.63	5.00	1	EPA SW-846 8270C	02/08/2012 07:46	02/08/2012 23:49	TD
193-39-5	Indeno(1,2,3-cd)pyrene	ND		ug/L	2.75	5.00	1	EPA SW-846 8270C	02/08/2012 07:46	02/08/2012 23:49	TD
78-59-1	Isophorone	ND		ug/L	3.23	5.00	1	EPA SW-846 8270C	02/08/2012 07:46	02/08/2012 23:49	TD
91-20-3	Naphthalene	ND		ug/L	3.86	5.00	1	EPA SW-846 8270C	02/08/2012 07:46	02/08/2012 23:49	TD
98-95-3	Nitrobenzene	ND		ug/L	1.97	5.00	1	EPA SW-846 8270C	02/08/2012 07:46	02/08/2012 23:49	TD
62-75-9	N-Nitrosodimethylamine	ND		ug/L	3.10	5.00	1	EPA SW-846 8270C	02/08/2012 07:46	02/08/2012 23:49	TD
621-64-7	N-nitroso-di-n-propylamine	ND		ug/L	2.57	5.00	1	EPA SW-846 8270C	02/08/2012 07:46	02/08/2012 23:49	TD
86-30-6	N-Nitrosodiphenylamine	ND		ug/L	3.62	5.00	1	EPA SW-846 8270C	02/08/2012 07:46	02/08/2012 23:49	TD
87-86-5	Pentachlorophenol	ND		ug/L	3.76	5.00	1	EPA SW-846 8270C	02/08/2012 07:46	02/08/2012 23:49	TD
85-01-8	Phenanthrene	ND		ug/L	3.61	5.00	1	EPA SW-846 8270C	02/08/2012 07:46	02/08/2012 23:49	TD
108-95-2	Phenol	ND		ug/L	3.27	5.00	1	EPA SW-846 8270C	02/08/2012 07:46	02/08/2012 23:49	TD
129-00-0	Pyrene	ND		ug/L	2.37	5.00	1	EPA SW-846 8270C	02/08/2012 07:46	02/08/2012 23:49	TD
96-1	Pyridine	ND		ug/L	3.19	5.00	1	EPA SW-846 8270C	02/08/2012 07:46	02/08/2012 23:49	TD

YORK

ANALYTICAL LABORATORIES, INC.

Sample Information

Client Sample ID: 515W18-SB/MW6-GW

York Sample ID: 12B0219-06

York Project (SDG) No.
12B0219

Client Project ID
515 West 18th St.

Matrix
Water

Collection Date/Time
February 6, 2012 3:00 pm

Date Received
02/07/2012

Volatiles Organics, 8260 List

Sample Prepared by Method: EPA 5030B

Log-in Notes:

Sample Notes:

CAS No.	Parameter	Result	Flag	Units	MDL	RL	Dilution	Reference Method	Date/Time Prepared	Date/Time Analyzed	Analyst
630-20-6	1,1,1,2-Tetrachloroethane	ND		ug/L	0.54	5.0	1	EPA SW846-8260B	02/09/2012 15:14	02/11/2012 22:25	SS
71-55-6	1,1,1-Trichloroethane	ND		ug/L	0.95	5.0	1	EPA SW846-8260B	02/09/2012 15:14	02/11/2012 22:25	SS
79-34-5	1,1,2,2-Tetrachloroethane	ND		ug/L	0.57	5.0	1	EPA SW846-8260B	02/09/2012 15:14	02/11/2012 22:25	SS
76-13-1	1,1,2-Trichloro-1,2,2-trifluoroethane (Freon 113)	ND		ug/L	0.60	5.0	1	EPA SW846-8260B	02/09/2012 15:14	02/11/2012 22:25	SS
79-00-5	1,1,2-Trichloroethane	ND		ug/L	0.61	5.0	1	EPA SW846-8260B	02/09/2012 15:14	02/11/2012 22:25	SS
75-34-3	1,1-Dichloroethane	ND		ug/L	0.69	5.0	1	EPA SW846-8260B	02/09/2012 15:14	02/11/2012 22:25	SS
75-35-4	1,1-Dichloroethylene	ND		ug/L	1.3	5.0	1	EPA SW846-8260B	02/09/2012 15:14	02/11/2012 22:25	SS
563-58-6	1,1-Dichloropropylene	ND		ug/L	0.43	5.0	1	EPA SW846-8260B	02/09/2012 15:14	02/11/2012 22:25	SS
87-61-6	1,2,3-Trichlorobenzene	ND		ug/L	0.37	10	1	EPA SW846-8260B	02/09/2012 15:14	02/11/2012 22:25	SS
96-18-4	1,2,3-Trichloropropane	ND		ug/L	1.1	5.0	1	EPA SW846-8260B	02/09/2012 15:14	02/11/2012 22:25	SS
120-82-1	1,2,4-Trichlorobenzene	ND		ug/L	0.48	10	1	EPA SW846-8260B	02/09/2012 15:14	02/11/2012 22:25	SS
95-63-6	1,2,4-Trimethylbenzene	1.1	J	ug/L	0.53	5.0	1	EPA SW846-8260B	02/09/2012 15:14	02/11/2012 22:25	SS
2-8	1,2-Dibromo-3-chloropropane	ND		ug/L	1.3	10	1	EPA SW846-8260B	02/09/2012 15:14	02/11/2012 22:25	SS
106-93-4	1,2-Dibromoethane	ND		ug/L	0.68	5.0	1	EPA SW846-8260B	02/09/2012 15:14	02/11/2012 22:25	SS
95-50-1	1,2-Dichlorobenzene	ND		ug/L	0.59	5.0	1	EPA SW846-8260B	02/09/2012 15:14	02/11/2012 22:25	SS
107-06-2	1,2-Dichloroethane	ND		ug/L	0.65	5.0	1	EPA SW846-8260B	02/09/2012 15:14	02/11/2012 22:25	SS
78-57-5	1,2-Dichloropropane	ND		ug/L	0.22	5.0	1	EPA SW846-8260B	02/09/2012 15:14	02/11/2012 22:25	SS
108-67-8	1,3,5-Trimethylbenzene	ND		ug/L	0.37	5.0	1	EPA SW846-8260B	02/09/2012 15:14	02/11/2012 22:25	SS
541-73-1	1,3-Dichlorobenzene	ND		ug/L	0.47	5.0	1	EPA SW846-8260B	02/09/2012 15:14	02/11/2012 22:25	SS
142-28-9	1,3-Dichloropropane	ND		ug/L	0.69	5.0	1	EPA SW846-8260B	02/09/2012 15:14	02/11/2012 22:25	SS
106-46-7	1,4-Dichlorobenzene	ND		ug/L	0.68	5.0	1	EPA SW846-8260B	02/09/2012 15:14	02/11/2012 22:25	SS
594-20-7	2,2-Dichloropropane	ND		ug/L	0.96	5.0	1	EPA SW846-8260B	02/09/2012 15:14	02/11/2012 22:25	SS
78-93-3	2-Butanone	ND		ug/L	2.6	10	1	EPA SW846-8260B	02/09/2012 15:14	02/11/2012 22:25	SS
95-49-8	2-Chlorotoluene	ND		ug/L	0.49	5.0	1	EPA SW846-8260B	02/09/2012 15:14	02/11/2012 22:25	SS
106-43-4	4-Chlorotoluene	ND		ug/L	0.49	5.0	1	EPA SW846-8260B	02/09/2012 15:14	02/11/2012 22:25	SS
67-64-1	Acetone	7.3	J, B	ug/L	3.1	10	1	EPA SW846-8260B	02/09/2012 15:14	02/11/2012 22:25	SS
71-43-2	Benzene	16		ug/L	0.48	5.0	1	EPA SW846-8260B	02/09/2012 15:14	02/11/2012 22:25	SS
108-86-1	Bromobenzene	ND		ug/L	0.61	5.0	1	EPA SW846-8260B	02/09/2012 15:14	02/11/2012 22:25	SS
74-97-5	Bromochloromethane	ND		ug/L	1.3	5.0	1	EPA SW846-8260B	02/09/2012 15:14	02/11/2012 22:25	SS
75-27-4	Bromodichloromethane	ND		ug/L	0.62	5.0	1	EPA SW846-8260B	02/09/2012 15:14	02/11/2012 22:25	SS
75-25-2	Bromoform	ND		ug/L	0.58	5.0	1	EPA SW846-8260B	02/09/2012 15:14	02/11/2012 22:25	SS
3-9	Bromomethane	ND		ug/L	1.2	5.0	1	EPA SW846-8260B	02/09/2012 15:14	02/11/2012 22:25	SS
56-23-5	Carbon tetrachloride	ND		ug/L	1.0	5.0	1	EPA SW846-8260B	02/09/2012 15:14	02/11/2012 22:25	SS
108-90-7	Chlorobenzene	ND		ug/L	0.35	5.0	1	EPA SW846-8260B	02/09/2012 15:14	02/11/2012 22:25	SS

YORK

ANALYTICAL LABORATORIES, INC.

Sample Information

Client Sample ID: **515W18-SB/MW6-GW**

York Sample ID: **12B0219-06**

York Project (SDG) No.
12B0219

Client Project ID
515 West 18th St.

Matrix
Water

Collection Date/Time
February 6, 2012 3:00 pm

Date Received
02/07/2012

Volatiles Organics, 8260 List

Sample Prepared by Method: EPA 5030B

Log-in Notes:

Sample Notes:

CAS No.	Parameter	Result	Flag	Units	MDL	RL	Dilution	Reference Method	Date/Time Prepared	Date/Time Analyzed	Analyst
75-00-3	Chloroethane	ND		ug/L	0.76	5.0	1	EPA SW846-8260B	02/09/2012 15:14	02/11/2012 22:25	SS
67-66-3	Chloroform	ND		ug/L	0.36	5.0	1	EPA SW846-8260B	02/09/2012 15:14	02/11/2012 22:25	SS
74-87-3	Chloromethane	ND		ug/L	0.89	5.0	1	EPA SW846-8260B	02/09/2012 15:14	02/11/2012 22:25	SS
156-59-2	cis-1,2-Dichloroethylene	ND		ug/L	0.96	5.0	1	EPA SW846-8260B	02/09/2012 15:14	02/11/2012 22:25	SS
10061-01-5	cis-1,3-Dichloropropylene	ND		ug/L	0.35	5.0	1	EPA SW846-8260B	02/09/2012 15:14	02/11/2012 22:25	SS
124-48-1	Dibromochloromethane	ND		ug/L	0.67	5.0	1	EPA SW846-8260B	02/09/2012 15:14	02/11/2012 22:25	SS
74-95-3	Dibromomethane	ND		ug/L	1.3	5.0	1	EPA SW846-8260B	02/09/2012 15:14	02/11/2012 22:25	SS
75-71-8	Dichlorodifluoromethane	ND		ug/L	0.83	5.0	1	EPA SW846-8260B	02/09/2012 15:14	02/11/2012 22:25	SS
100-41-4	Ethyl Benzene	2.2	J	ug/L	0.35	5.0	1	EPA SW846-8260B	02/09/2012 15:14	02/11/2012 22:25	SS
87-68-3	Hexachlorobutadiene	ND		ug/L	0.43	5.0	1	EPA SW846-8260B	02/09/2012 15:14	02/11/2012 22:25	SS
98-82-8	Isopropylbenzene	11		ug/L	0.39	5.0	1	EPA SW846-8260B	02/09/2012 15:14	02/11/2012 22:25	SS
1634-04-4	Methyl tert-butyl ether (MTBE)	7.0		ug/L	0.38	5.0	1	EPA SW846-8260B	02/09/2012 15:14	02/11/2012 22:25	SS
75-70-2	Methylene chloride	3.4	J, B	ug/L	1.1	10	1	EPA SW846-8260B	02/09/2012 15:14	02/11/2012 22:25	SS
100-02-3	Naphthalene	1.8	J	ug/L	0.50	10	1	EPA SW846-8260B	02/09/2012 15:14	02/11/2012 22:25	SS
104-51-8	n-Butylbenzene	2.4	J	ug/L	0.32	5.0	1	EPA SW846-8260B	02/09/2012 15:14	02/11/2012 22:25	SS
103-65-1	n-Propylbenzene	10		ug/L	0.58	5.0	1	EPA SW846-8260B	02/09/2012 15:14	02/11/2012 22:25	SS
95-47-6	o-Xylene	1.4	J	ug/L	0.50	5.0	1	EPA SW846-8260B	02/09/2012 15:14	02/11/2012 22:25	SS
1330-20-7P/M	p- & m- Xylenes	1.9	J	ug/L	0.55	10	1	EPA SW846-8260B	02/09/2012 15:14	02/11/2012 22:25	SS
99-87-6	p-Isopropyltoluene	5.4		ug/L	0.25	5.0	1	EPA SW846-8260B	02/09/2012 15:14	02/11/2012 22:25	SS
135-98-8	sec-Butylbenzene	3.4	J	ug/L	0.52	5.0	1	EPA SW846-8260B	02/09/2012 15:14	02/11/2012 22:25	SS
100-42-5	Styrene	ND		ug/L	0.43	5.0	1	EPA SW846-8260B	02/09/2012 15:14	02/11/2012 22:25	SS
98-06-6	tert-Butylbenzene	ND		ug/L	0.46	5.0	1	EPA SW846-8260B	02/09/2012 15:14	02/11/2012 22:25	SS
127-18-4	Tetrachloroethylene	ND		ug/L	0.52	5.0	1	EPA SW846-8260B	02/09/2012 15:14	02/11/2012 22:25	SS
108-88-3	Toluene	0.93	J	ug/L	0.23	5.0	1	EPA SW846-8260B	02/09/2012 15:14	02/11/2012 22:25	SS
156-60-5	trans-1,2-Dichloroethylene	ND		ug/L	0.65	5.0	1	EPA SW846-8260B	02/09/2012 15:14	02/11/2012 22:25	SS
10061-02-6	trans-1,3-Dichloropropylene	ND		ug/L	0.68	5.0	1	EPA SW846-8260B	02/09/2012 15:14	02/11/2012 22:25	SS
79-01-6	Trichloroethylene	ND		ug/L	0.57	5.0	1	EPA SW846-8260B	02/09/2012 15:14	02/11/2012 22:25	SS
75-69-4	Trichlorofluoromethane	ND		ug/L	0.91	5.0	1	EPA SW846-8260B	02/09/2012 15:14	02/11/2012 22:25	SS
75-01-4	Vinyl Chloride	ND		ug/L	0.97	5.0	1	EPA SW846-8260B	02/09/2012 15:14	02/11/2012 22:25	SS
1330-20-7	Xylenes, Total	3.2	J	ug/L	1.0	15	1	EPA SW846-8260B	02/09/2012 15:14	02/11/2012 22:25	SS

YORK

ANALYTICAL LABORATORIES, INC.

Sample Information

Client Sample ID: 515W18-SB/MW6-GW

York Sample ID: 12B0219-06

York Project (SDG) No.
12B0219

Client Project ID
515 West 18th St.

Matrix
Water

Collection Date/Time
February 6, 2012 3:00 pm

Date Received
02/07/2012

Semi-Volatiles, 8270 Target List

Log-in Notes:

Sample Notes:

Sample Prepared by Method: EPA 3510C

CAS No.	Parameter	Result	Flag	Units	MDL	RL	Dilution	Reference Method	Date/Time Prepared	Date/Time Analyzed	Analyst
120-82-1	1,2,4-Trichlorobenzene	ND		ug/L	1.50	5.71	1	EPA SW-846 8270C	02/08/2012 07:46	02/09/2012 00:20	TD
95-50-1	1,2-Dichlorobenzene	ND		ug/L	1.87	5.71	1	EPA SW-846 8270C	02/08/2012 07:46	02/09/2012 00:20	TD
541-73-1	1,3-Dichlorobenzene	ND		ug/L	3.14	5.71	1	EPA SW-846 8270C	02/08/2012 07:46	02/09/2012 00:20	TD
106-46-7	1,4-Dichlorobenzene	ND		ug/L	3.69	5.71	1	EPA SW-846 8270C	02/08/2012 07:46	02/09/2012 00:20	TD
95-95-4	2,4,5-Trichlorophenol	ND		ug/L	4.12	5.71	1	EPA SW-846 8270C	02/08/2012 07:46	02/09/2012 00:20	TD
88-06-2	2,4,6-Trichlorophenol	ND		ug/L	3.74	5.71	1	EPA SW-846 8270C	02/08/2012 07:46	02/09/2012 00:20	TD
120-83-2	2,4-Dichlorophenol	ND		ug/L	3.53	5.71	1	EPA SW-846 8270C	02/08/2012 07:46	02/09/2012 00:20	TD
105-67-9	2,4-Dimethylphenol	ND		ug/L	4.21	5.71	1	EPA SW-846 8270C	02/08/2012 07:46	02/09/2012 00:20	TD
51-28-5	2,4-Dinitrophenol	ND		ug/L	11.0	11.4	1	EPA SW-846 8270C	02/08/2012 07:46	02/09/2012 00:20	TD
121-14-2	2,4-Dinitrotoluene	ND		ug/L	2.70	5.71	1	EPA SW-846 8270C	02/08/2012 07:46	02/09/2012 00:20	TD
606-20-2	2,6-Dinitrotoluene	ND		ug/L	4.01	5.71	1	EPA SW-846 8270C	02/08/2012 07:46	02/09/2012 00:20	TD
91-58-7	2-Chloronaphthalene	ND		ug/L	3.99	5.71	1	EPA SW-846 8270C	02/08/2012 07:46	02/09/2012 00:20	TD
57-8	2-Chlorophenol	ND		ug/L	3.90	5.71	1	EPA SW-846 8270C	02/08/2012 07:46	02/09/2012 00:20	TD
91-57-6	2-Methylnaphthalene	ND		ug/L	3.51	5.71	1	EPA SW-846 8270C	02/08/2012 07:46	02/09/2012 00:20	TD
95-48-7	2-Methylphenol	ND		ug/L	0.980	5.71	1	EPA SW-846 8270C	02/08/2012 07:46	02/09/2012 00:20	TD
88-74-4	2-Nitroaniline	ND		ug/L	3.44	5.71	1	EPA SW-846 8270C	02/08/2012 07:46	02/09/2012 00:20	TD
88-75-5	2-Nitrophenol	ND		ug/L	3.55	5.71	1	EPA SW-846 8270C	02/08/2012 07:46	02/09/2012 00:20	TD
100-01-6	3- & 4-Methylphenols	ND		ug/L	4.25	5.71	1	EPA SW-846 8270C	02/08/2012 07:46	02/09/2012 00:20	TD
91-94-1	3,3'-Dichlorobenzidine	ND		ug/L	4.01	5.71	1	EPA SW-846 8270C	02/08/2012 07:46	02/09/2012 00:20	TD
99-09-2	3-Nitroaniline	ND		ug/L	1.82	5.71	1	EPA SW-846 8270C	02/08/2012 07:46	02/09/2012 00:20	TD
534-52-1	4,6-Dinitro-2-methylphenol	ND		ug/L	7.66	11.4	1	EPA SW-846 8270C	02/08/2012 07:46	02/09/2012 00:20	TD
101-55-3	4-Bromophenyl phenyl ether	ND		ug/L	3.94	5.71	1	EPA SW-846 8270C	02/08/2012 07:46	02/09/2012 00:20	TD
59-50-7	4-Chloro-3-methylphenol	ND		ug/L	4.15	5.71	1	EPA SW-846 8270C	02/08/2012 07:46	02/09/2012 00:20	TD
106-47-8	4-Chloroaniline	ND		ug/L	4.27	5.71	1	EPA SW-846 8270C	02/08/2012 07:46	02/09/2012 00:20	TD
7005-72-3	4-Chlorophenyl phenyl ether	ND		ug/L	3.57	5.71	1	EPA SW-846 8270C	02/08/2012 07:46	02/09/2012 00:20	TD
100-02-7	4-Nitroaniline	ND		ug/L	4.31	5.71	1	EPA SW-846 8270C	02/08/2012 07:46	02/09/2012 00:20	TD
56-57-5	4-Nitrophenol	ND		ug/L	4.50	5.71	1	EPA SW-846 8270C	02/08/2012 07:46	02/09/2012 00:20	TD
83-32-9	Acenaphthene	ND		ug/L	3.70	5.71	1	EPA SW-846 8270C	02/08/2012 07:46	02/09/2012 00:20	TD
208-96-8	Acenaphthylene	ND		ug/L	4.89	5.71	1	EPA SW-846 8270C	02/08/2012 07:46	02/09/2012 00:20	TD
62-53-3	Aniline	ND		ug/L	2.25	5.71	1	EPA SW-846 8270C	02/08/2012 07:46	02/09/2012 00:20	TD
120-12-7	Anthracene	ND		ug/L	4.18	5.71	1	EPA SW-846 8270C	02/08/2012 07:46	02/09/2012 00:20	TD
5-3	Benzo(a)anthracene	ND		ug/L	4.65	5.71	1	EPA SW-846 8270C	02/08/2012 07:46	02/09/2012 00:20	TD
32-8	Benzo(a)pyrene	ND		ug/L	5.54	5.71	1	EPA SW-846 8270C	02/08/2012 07:46	02/09/2012 00:20	TD
205-99-2	Benzo(b)fluoranthene	ND		ug/L	4.71	5.71	1	EPA SW-846 8270C	02/08/2012 07:46	02/09/2012 00:20	TD
191-24-2	Benzo(g,h,i)perylene	ND		ug/L	4.75	5.71	1	EPA SW-846 8270C	02/08/2012 07:46	02/09/2012 00:20	TD

YORK

ANALYTICAL LABORATORIES, INC.

Sample Information

Client Sample ID: 515W18-SB/MW6-GW

York Sample ID: 12B0219-06

York Project (SDG) No.
12B0219

Client Project ID
515 West 18th St.

Matrix
Water

Collection Date/Time
February 6, 2012 3:00 pm

Date Received
02/07/2012

Semi-Volatiles, 8270 Target List

Log-in Notes:

Sample Notes:

Sample Prepared by Method: EPA 3510C

CAS No.	Parameter	Result	Flag	Units	MDL	RL	Dilution	Reference Method	Date/Time Prepared	Date/Time Analyzed	Analyst
207-08-9	Benzo(k)fluoranthene	ND		ug/L	3.95	5.71	1	EPA SW-846 8270C	02/08/2012 07:46	02/09/2012 00:20	TD
100-51-6	Benzyl alcohol	ND		ug/L	4.57	5.71	1	EPA SW-846 8270C	02/08/2012 07:46	02/09/2012 00:20	TD
85-68-7	Benzyl butyl phthalate	ND		ug/L	2.63	5.71	1	EPA SW-846 8270C	02/08/2012 07:46	02/09/2012 00:20	TD
111-91-1	Bis(2-chloroethoxy)methane	ND		ug/L	5.54	5.71	1	EPA SW-846 8270C	02/08/2012 07:46	02/09/2012 00:20	TD
111-44-4	Bis(2-chloroethyl)ether	ND		ug/L	4.71	5.71	1	EPA SW-846 8270C	02/08/2012 07:46	02/09/2012 00:20	TD
108-60-1	Bis(2-chloroisopropyl)ether	ND		ug/L	4.75	5.71	1	EPA SW-846 8270C	02/08/2012 07:46	02/09/2012 00:20	TD
117-81-7	Bis(2-ethylhexyl)phthalate	ND		ug/L	2.94	5.71	1	EPA SW-846 8270C	02/08/2012 07:46	02/09/2012 00:20	TD
218-01-9	Chrysene	ND		ug/L	4.75	5.71	1	EPA SW-846 8270C	02/08/2012 07:46	02/09/2012 00:20	TD
53-70-3	Dibenzo(a,h)anthracene	ND		ug/L	3.54	5.71	1	EPA SW-846 8270C	02/08/2012 07:46	02/09/2012 00:20	TD
132-64-9	Dibenzofuran	ND		ug/L	3.31	5.71	1	EPA SW-846 8270C	02/08/2012 07:46	02/09/2012 00:20	TD
84-66-2	Diethyl phthalate	ND		ug/L	2.51	5.71	1	EPA SW-846 8270C	02/08/2012 07:46	02/09/2012 00:20	TD
131-11-3	Dimethyl phthalate	ND		ug/L	5.54	5.71	1	EPA SW-846 8270C	02/08/2012 07:46	02/09/2012 00:20	TD
74-2	Di-n-butyl phthalate	ND		ug/L	4.71	5.71	1	EPA SW-846 8270C	02/08/2012 07:46	02/09/2012 00:20	TD
117-84-0	Di-n-octyl phthalate	ND		ug/L	4.75	5.71	1	EPA SW-846 8270C	02/08/2012 07:46	02/09/2012 00:20	TD
206-44-0	Fluoranthene	ND		ug/L	1.82	5.71	1	EPA SW-846 8270C	02/08/2012 07:46	02/09/2012 00:20	TD
86-73-7	Fluorene	ND		ug/L	3.69	5.71	1	EPA SW-846 8270C	02/08/2012 07:46	02/09/2012 00:20	TD
118-74-1	Hexachlorobenzene	ND		ug/L	3.38	5.71	1	EPA SW-846 8270C	02/08/2012 07:46	02/09/2012 00:20	TD
87-68-3	Hexachlorobutadiene	ND		ug/L	3.78	5.71	1	EPA SW-846 8270C	02/08/2012 07:46	02/09/2012 00:20	TD
77-47-4	Hexachlorocyclopentadiene	ND		ug/L	3.94	5.71	1	EPA SW-846 8270C	02/08/2012 07:46	02/09/2012 00:20	TD
67-72-1	Hexachloroethane	ND		ug/L	4.15	5.71	1	EPA SW-846 8270C	02/08/2012 07:46	02/09/2012 00:20	TD
193-39-5	Indeno(1,2,3-cd)pyrene	ND		ug/L	3.14	5.71	1	EPA SW-846 8270C	02/08/2012 07:46	02/09/2012 00:20	TD
78-59-1	Isophorone	ND		ug/L	3.69	5.71	1	EPA SW-846 8270C	02/08/2012 07:46	02/09/2012 00:20	TD
91-20-3	Naphthalene	ND		ug/L	4.41	5.71	1	EPA SW-846 8270C	02/08/2012 07:46	02/09/2012 00:20	TD
98-95-3	Nitrobenzene	ND		ug/L	2.25	5.71	1	EPA SW-846 8270C	02/08/2012 07:46	02/09/2012 00:20	TD
62-75-9	N-Nitrosodimethylamine	ND		ug/L	3.55	5.71	1	EPA SW-846 8270C	02/08/2012 07:46	02/09/2012 00:20	TD
621-64-7	N-nitroso-di-n-propylamine	ND		ug/L	2.94	5.71	1	EPA SW-846 8270C	02/08/2012 07:46	02/09/2012 00:20	TD
86-30-6	N-Nitrosodiphenylamine	ND		ug/L	4.14	5.71	1	EPA SW-846 8270C	02/08/2012 07:46	02/09/2012 00:20	TD
87-86-5	Pentachlorophenol	ND		ug/L	4.30	5.71	1	EPA SW-846 8270C	02/08/2012 07:46	02/09/2012 00:20	TD
85-01-8	Phenanthrene	ND		ug/L	4.12	5.71	1	EPA SW-846 8270C	02/08/2012 07:46	02/09/2012 00:20	TD
108-95-2	Phenol	ND		ug/L	3.74	5.71	1	EPA SW-846 8270C	02/08/2012 07:46	02/09/2012 00:20	TD
129-00-0	Pyrene	ND		ug/L	2.70	5.71	1	EPA SW-846 8270C	02/08/2012 07:46	02/09/2012 00:20	TD
86-1	Pyridine	ND		ug/L	3.64	5.71	1	EPA SW-846 8270C	02/08/2012 07:46	02/09/2012 00:20	TD

YORK

ANALYTICAL LABORATORIES, INC.

Sample Information

Client Sample ID: 515W18-SB/MW219-GW

York Sample ID: 12B0219-07

York Project (SDG) No.
12B0219

Client Project ID
515 West 18th St.

Matrix
Water

Collection Date/Time
February 6, 2012 3:00 pm

Date Received
02/07/2012

Volatile Organics, 8260 List

Log-in Notes:

Sample Notes:

Sample Prepared by Method: EPA 5030B

CAS No.	Parameter	Result	Flag	Units	MDL	RL	Dilution	Reference Method	Date/Time Prepared	Date/Time Analyzed	Analyst
630-20-6	1,1,1,2-Tetrachloroethane	ND		ug/L	0.54	5.0	1	EPA SW846-8260B	02/09/2012 15:14	02/10/2012 06:54	SS
71-55-6	1,1,1-Trichloroethane	ND		ug/L	0.95	5.0	1	EPA SW846-8260B	02/09/2012 15:14	02/10/2012 06:54	SS
79-34-5	1,1,2,2-Tetrachloroethane	ND		ug/L	0.57	5.0	1	EPA SW846-8260B	02/09/2012 15:14	02/10/2012 06:54	SS
76-13-1	1,1,2-Trichloro-1,2,2-trifluoroethane (Freon 113)	ND		ug/L	0.60	5.0	1	EPA SW846-8260B	02/09/2012 15:14	02/10/2012 06:54	SS
79-00-5	1,1,2-Trichloroethane	ND		ug/L	0.61	5.0	1	EPA SW846-8260B	02/09/2012 15:14	02/10/2012 06:54	SS
75-34-3	1,1-Dichloroethane	ND		ug/L	0.69	5.0	1	EPA SW846-8260B	02/09/2012 15:14	02/10/2012 06:54	SS
75-35-4	1,1-Dichloroethylene	ND		ug/L	1.3	5.0	1	EPA SW846-8260B	02/09/2012 15:14	02/10/2012 06:54	SS
563-58-6	1,1-Dichloropropylene	ND		ug/L	0.43	5.0	1	EPA SW846-8260B	02/09/2012 15:14	02/10/2012 06:54	SS
87-61-6	1,2,3-Trichlorobenzene	ND		ug/L	0.37	10	1	EPA SW846-8260B	02/09/2012 15:14	02/10/2012 06:54	SS
96-18-4	1,2,3-Trichloropropane	ND		ug/L	1.1	5.0	1	EPA SW846-8260B	02/09/2012 15:14	02/10/2012 06:54	SS
120-82-1	1,2,4-Trichlorobenzene	ND		ug/L	0.48	10	1	EPA SW846-8260B	02/09/2012 15:14	02/10/2012 06:54	SS
95-63-6	1,2,4-Trimethylbenzene	ND		ug/L	0.53	5.0	1	EPA SW846-8260B	02/09/2012 15:14	02/10/2012 06:54	SS
8	1,2-Dibromo-3-chloropropane	ND		ug/L	1.3	10	1	EPA SW846-8260B	02/09/2012 15:14	02/10/2012 06:54	SS
106-93-4	1,2-Dibromoethane	ND		ug/L	0.68	5.0	1	EPA SW846-8260B	02/09/2012 15:14	02/10/2012 06:54	SS
95-50-1	1,2-Dichlorobenzene	ND		ug/L	0.59	5.0	1	EPA SW846-8260B	02/09/2012 15:14	02/10/2012 06:54	SS
107-06-2	1,2-Dichloroethane	ND		ug/L	0.65	5.0	1	EPA SW846-8260B	02/09/2012 15:14	02/10/2012 06:54	SS
78-87-5	1,2-Dichloropropane	ND		ug/L	0.22	5.0	1	EPA SW846-8260B	02/09/2012 15:14	02/10/2012 06:54	SS
108-67-8	1,3,5-Trimethylbenzene	ND		ug/L	0.37	5.0	1	EPA SW846-8260B	02/09/2012 15:14	02/10/2012 06:54	SS
541-73-1	1,3-Dichlorobenzene	ND		ug/L	0.47	5.0	1	EPA SW846-8260B	02/09/2012 15:14	02/10/2012 06:54	SS
142-28-9	1,3-Dichloropropane	ND		ug/L	0.69	5.0	1	EPA SW846-8260B	02/09/2012 15:14	02/10/2012 06:54	SS
106-46-7	1,4-Dichlorobenzene	ND		ug/L	0.68	5.0	1	EPA SW846-8260B	02/09/2012 15:14	02/10/2012 06:54	SS
594-20-7	2,2-Dichloropropane	ND		ug/L	0.96	5.0	1	EPA SW846-8260B	02/09/2012 15:14	02/10/2012 06:54	SS
78-93-3	2-Butanone	ND		ug/L	2.6	10	1	EPA SW846-8260B	02/09/2012 15:14	02/10/2012 06:54	SS
95-49-8	2-Chlorotoluene	ND		ug/L	0.49	5.0	1	EPA SW846-8260B	02/09/2012 15:14	02/10/2012 06:54	SS
106-43-4	4-Chlorotoluene	ND		ug/L	0.49	5.0	1	EPA SW846-8260B	02/09/2012 15:14	02/10/2012 06:54	SS
67-64-1	Acetone	ND		ug/L	3.1	10	1	EPA SW846-8260B	02/09/2012 15:14	02/10/2012 06:54	SS
71-43-2	Benzene	ND		ug/L	0.48	5.0	1	EPA SW846-8260B	02/09/2012 15:14	02/10/2012 06:54	SS
108-86-1	Bromobenzene	ND		ug/L	0.61	5.0	1	EPA SW846-8260B	02/09/2012 15:14	02/10/2012 06:54	SS
74-97-5	Bromochloromethane	ND		ug/L	1.3	5.0	1	EPA SW846-8260B	02/09/2012 15:14	02/10/2012 06:54	SS
75-27-4	Bromodichloromethane	ND		ug/L	0.62	5.0	1	EPA SW846-8260B	02/09/2012 15:14	02/10/2012 06:54	SS
75-25-2	Bromoform	ND		ug/L	0.58	5.0	1	EPA SW846-8260B	02/09/2012 15:14	02/10/2012 06:54	SS
9	Bromomethane	ND		ug/L	1.2	5.0	1	EPA SW846-8260B	02/09/2012 15:14	02/10/2012 06:54	SS
56-23-5	Carbon tetrachloride	ND		ug/L	1.0	5.0	1	EPA SW846-8260B	02/09/2012 15:14	02/10/2012 06:54	SS
108-90-7	Chlorobenzene	ND		ug/L	0.35	5.0	1	EPA SW846-8260B	02/09/2012 15:14	02/10/2012 06:54	SS

YORK

ANALYTICAL LABORATORIES, INC.

Sample Information

Client Sample ID: 515W18-SB/MW219-GW

York Sample ID: 12B0219-07

York Project (SDG) No.
12B0219

Client Project ID
515 West 18th St.

Matrix
Water

Collection Date/Time
February 6, 2012 3:00 pm

Date Received
02/07/2012

Volatile Organics, 8260 List

Sample Prepared by Method: EPA 5030B

Log-in Notes:

Sample Notes:

CAS No.	Parameter	Result	Flag	Units	MDL	RL	Dilution	Reference Method	Date/Time Prepared	Date/Time Analyzed	Analyst
75-00-3	Chloroethane	ND		ug/L	0.76	5.0	1	EPA SW846-8260B	02/09/2012 15:14	02/10/2012 06:54	SS
67-66-3	Chloroform	ND		ug/L	0.36	5.0	1	EPA SW846-8260B	02/09/2012 15:14	02/10/2012 06:54	SS
74-87-3	Chloromethane	ND		ug/L	0.89	5.0	1	EPA SW846-8260B	02/09/2012 15:14	02/10/2012 06:54	SS
156-59-2	cis-1,2-Dichloroethylene	ND		ug/L	0.96	5.0	1	EPA SW846-8260B	02/09/2012 15:14	02/10/2012 06:54	SS
10061-01-5	cis-1,3-Dichloropropylene	ND		ug/L	0.35	5.0	1	EPA SW846-8260B	02/09/2012 15:14	02/10/2012 06:54	SS
124-48-1	Dibromochloromethane	ND		ug/L	0.67	5.0	1	EPA SW846-8260B	02/09/2012 15:14	02/10/2012 06:54	SS
74-95-3	Dibromomethane	ND		ug/L	1.3	5.0	1	EPA SW846-8260B	02/09/2012 15:14	02/10/2012 06:54	SS
75-71-8	Dichlorodifluoromethane	ND		ug/L	0.83	5.0	1	EPA SW846-8260B	02/09/2012 15:14	02/10/2012 06:54	SS
100-41-4	Ethyl Benzene	ND		ug/L	0.35	5.0	1	EPA SW846-8260B	02/09/2012 15:14	02/10/2012 06:54	SS
87-68-3	Hexachlorobutadiene	ND		ug/L	0.43	5.0	1	EPA SW846-8260B	02/09/2012 15:14	02/10/2012 06:54	SS
98-82-8	Isopropylbenzene	ND		ug/L	0.39	5.0	1	EPA SW846-8260B	02/09/2012 15:14	02/10/2012 06:54	SS
1634-04-4	Methyl tert-butyl ether (MTBE)	1.8	J	ug/L	0.38	5.0	1	EPA SW846-8260B	02/09/2012 15:14	02/10/2012 06:54	SS
-2	Methylene chloride	4.1	J, B	ug/L	1.1	10	1	EPA SW846-8260B	02/09/2012 15:14	02/10/2012 06:54	SS
9-20-3	Naphthalene	ND		ug/L	0.50	10	1	EPA SW846-8260B	02/09/2012 15:14	02/10/2012 06:54	SS
104-51-8	n-Butylbenzene	ND		ug/L	0.32	5.0	1	EPA SW846-8260B	02/09/2012 15:14	02/10/2012 06:54	SS
103-65-1	n-Propylbenzene	ND		ug/L	0.58	5.0	1	EPA SW846-8260B	02/09/2012 15:14	02/10/2012 06:54	SS
95-47-6	o-Xylene	ND		ug/L	0.50	5.0	1	EPA SW846-8260B	02/09/2012 15:14	02/10/2012 06:54	SS
1330-20-7P/M	p- & m- Xylenes	ND		ug/L	0.55	10	1	EPA SW846-8260B	02/09/2012 15:14	02/10/2012 06:54	SS
99-87-6	p-Isopropyltoluene	ND		ug/L	0.25	5.0	1	EPA SW846-8260B	02/09/2012 15:14	02/10/2012 06:54	SS
135-98-8	sec-Butylbenzene	ND		ug/L	0.52	5.0	1	EPA SW846-8260B	02/09/2012 15:14	02/10/2012 06:54	SS
100-42-5	Styrene	ND		ug/L	0.43	5.0	1	EPA SW846-8260B	02/09/2012 15:14	02/10/2012 06:54	SS
98-06-6	tert-Butylbenzene	ND		ug/L	0.46	5.0	1	EPA SW846-8260B	02/09/2012 15:14	02/10/2012 06:54	SS
127-18-4	Tetrachloroethylene	ND		ug/L	0.52	5.0	1	EPA SW846-8260B	02/09/2012 15:14	02/10/2012 06:54	SS
108-88-3	Toluene	ND		ug/L	0.23	5.0	1	EPA SW846-8260B	02/09/2012 15:14	02/10/2012 06:54	SS
156-60-5	trans-1,2-Dichloroethylene	ND		ug/L	0.65	5.0	1	EPA SW846-8260B	02/09/2012 15:14	02/10/2012 06:54	SS
10061-02-6	trans-1,3-Dichloropropylene	ND		ug/L	0.68	5.0	1	EPA SW846-8260B	02/09/2012 15:14	02/10/2012 06:54	SS
79-01-6	Trichloroethylene	ND		ug/L	0.57	5.0	1	EPA SW846-8260B	02/09/2012 15:14	02/10/2012 06:54	SS
75-69-4	Trichlorofluoromethane	ND		ug/L	0.91	5.0	1	EPA SW846-8260B	02/09/2012 15:14	02/10/2012 06:54	SS
75-01-4	Vinyl Chloride	ND		ug/L	0.97	5.0	1	EPA SW846-8260B	02/09/2012 15:14	02/10/2012 06:54	SS
1330-20-7	Xylenes, Total	ND		ug/L	1.0	15	1	EPA SW846-8260B	02/09/2012 15:14	02/10/2012 06:54	SS

YORK

ANALYTICAL LABORATORIES, INC.

Sample Information

Client Sample ID: 515W18-SB/MW219-GW

York Sample ID: 12B0219-07

York Project (SDG) No.
12B0219

Client Project ID
515 West 18th St.

Matrix
Water

Collection Date/Time
February 6, 2012 3:00 pm

Date Received
02/07/2012

Semi-Volatiles, 8270 Target List

Log-in Notes:

Sample Notes:

Sample Prepared by Method: EPA 3510C

CAS No.	Parameter	Result	Flag	Units	MDL	RL	Dilution	Reference Method	Date/Time Prepared	Date/Time Analyzed	Analyst
120-82-1	1,2,4-Trichlorobenzene	ND		ug/L	1.38	5.26	1	EPA SW-846 8270C	02/08/2012 07:46	02/09/2012 00:52	TD
95-50-1	1,2-Dichlorobenzene	ND		ug/L	1.72	5.26	1	EPA SW-846 8270C	02/08/2012 07:46	02/09/2012 00:52	TD
541-73-1	1,3-Dichlorobenzene	ND		ug/L	2.89	5.26	1	EPA SW-846 8270C	02/08/2012 07:46	02/09/2012 00:52	TD
106-46-7	1,4-Dichlorobenzene	ND		ug/L	3.40	5.26	1	EPA SW-846 8270C	02/08/2012 07:46	02/09/2012 00:52	TD
95-95-4	2,4,5-Trichlorophenol	ND		ug/L	3.80	5.26	1	EPA SW-846 8270C	02/08/2012 07:46	02/09/2012 00:52	TD
88-06-2	2,4,6-Trichlorophenol	ND		ug/L	3.44	5.26	1	EPA SW-846 8270C	02/08/2012 07:46	02/09/2012 00:52	TD
120-83-2	2,4-Dichlorophenol	ND		ug/L	3.25	5.26	1	EPA SW-846 8270C	02/08/2012 07:46	02/09/2012 00:52	TD
105-67-9	2,4-Dimethylphenol	ND		ug/L	3.88	5.26	1	EPA SW-846 8270C	02/08/2012 07:46	02/09/2012 00:52	TD
51-28-5	2,4-Dinitrophenol	ND		ug/L	10.1	10.5	1	EPA SW-846 8270C	02/08/2012 07:46	02/09/2012 00:52	TD
121-14-2	2,4-Dinitrotoluene	ND		ug/L	2.49	5.26	1	EPA SW-846 8270C	02/08/2012 07:46	02/09/2012 00:52	TD
606-20-2	2,6-Dinitrotoluene	ND		ug/L	3.69	5.26	1	EPA SW-846 8270C	02/08/2012 07:46	02/09/2012 00:52	TD
91-58-7	2-Chloronaphthalene	ND		ug/L	3.67	5.26	1	EPA SW-846 8270C	02/08/2012 07:46	02/09/2012 00:52	TD
87-86-8	2-Chlorophenol	ND		ug/L	3.60	5.26	1	EPA SW-846 8270C	02/08/2012 07:46	02/09/2012 00:52	TD
91-57-6	2-Methylnaphthalene	ND		ug/L	3.24	5.26	1	EPA SW-846 8270C	02/08/2012 07:46	02/09/2012 00:52	TD
95-48-7	2-Methylphenol	ND		ug/L	0.902	5.26	1	EPA SW-846 8270C	02/08/2012 07:46	02/09/2012 00:52	TD
88-74-4	2-Nitroaniline	ND		ug/L	3.17	5.26	1	EPA SW-846 8270C	02/08/2012 07:46	02/09/2012 00:52	TD
88-75-5	2-Nitrophenol	ND		ug/L	3.27	5.26	1	EPA SW-846 8270C	02/08/2012 07:46	02/09/2012 00:52	TD
100-01-6	3- & 4-Methylphenols	ND		ug/L	3.91	5.26	1	EPA SW-846 8270C	02/08/2012 07:46	02/09/2012 00:52	TD
91-94-1	3,3'-Dichlorobenzidine	ND		ug/L	3.70	5.26	1	EPA SW-846 8270C	02/08/2012 07:46	02/09/2012 00:52	TD
99-09-2	3-Nitroaniline	ND		ug/L	1.68	5.26	1	EPA SW-846 8270C	02/08/2012 07:46	02/09/2012 00:52	TD
534-52-1	4,6-Dinitro-2-methylphenol	ND		ug/L	7.05	10.5	1	EPA SW-846 8270C	02/08/2012 07:46	02/09/2012 00:52	TD
101-55-3	4-Bromophenyl phenyl ether	ND		ug/L	3.63	5.26	1	EPA SW-846 8270C	02/08/2012 07:46	02/09/2012 00:52	TD
59-50-7	4-Chloro-3-methylphenol	ND		ug/L	3.82	5.26	1	EPA SW-846 8270C	02/08/2012 07:46	02/09/2012 00:52	TD
106-47-8	4-Chloroaniline	ND		ug/L	3.94	5.26	1	EPA SW-846 8270C	02/08/2012 07:46	02/09/2012 00:52	TD
7005-72-3	4-Chlorophenyl phenyl ether	ND		ug/L	3.28	5.26	1	EPA SW-846 8270C	02/08/2012 07:46	02/09/2012 00:52	TD
100-02-7	4-Nitroaniline	ND		ug/L	3.97	5.26	1	EPA SW-846 8270C	02/08/2012 07:46	02/09/2012 00:52	TD
56-57-5	4-Nitrophenol	ND		ug/L	4.15	5.26	1	EPA SW-846 8270C	02/08/2012 07:46	02/09/2012 00:52	TD
83-32-9	Acenaphthene	ND		ug/L	3.41	5.26	1	EPA SW-846 8270C	02/08/2012 07:46	02/09/2012 00:52	TD
208-96-8	Acenaphthylene	ND		ug/L	4.50	5.26	1	EPA SW-846 8270C	02/08/2012 07:46	02/09/2012 00:52	TD
62-53-3	Aniline	ND		ug/L	2.07	5.26	1	EPA SW-846 8270C	02/08/2012 07:46	02/09/2012 00:52	TD
120-12-7	Anthracene	ND		ug/L	3.85	5.26	1	EPA SW-846 8270C	02/08/2012 07:46	02/09/2012 00:52	TD
120-12-3	Benzo(a)anthracene	ND		ug/L	4.28	5.26	1	EPA SW-846 8270C	02/08/2012 07:46	02/09/2012 00:52	TD
50-12-8	Benzo(a)pyrene	ND		ug/L	5.10	5.26	1	EPA SW-846 8270C	02/08/2012 07:46	02/09/2012 00:52	TD
205-99-2	Benzo(b)fluoranthene	ND		ug/L	4.34	5.26	1	EPA SW-846 8270C	02/08/2012 07:46	02/09/2012 00:52	TD
191-24-2	Benzo(g,h,i)perylene	ND		ug/L	4.37	5.26	1	EPA SW-846 8270C	02/08/2012 07:46	02/09/2012 00:52	TD

YORK

ANALYTICAL LABORATORIES, INC.

Sample Information

Client Sample ID: 515W18-SB/MW219-GW

York Sample ID: 12B0219-07

York Project (SDG) No.
12B0219

Client Project ID
515 West 18th St.

Matrix
Water

Collection Date/Time
February 6, 2012 3:00 pm

Date Received
02/07/2012

Semi-Volatiles, 8270 Target List

Log-in Notes:

Sample Notes:

Sample Prepared by Method: EPA 3510C

CAS No.	Parameter	Result	Flag	Units	MDL	RL	Dilution	Reference Method	Date/Time Prepared	Date/Time Analyzed	Analyst
207-08-9	Benzo(k)fluoranthene	ND		ug/L	3.64	5.26	1	EPA SW-846 8270C	02/08/2012 07:46	02/09/2012 00:52	TD
100-51-6	Benzyl alcohol	ND		ug/L	4.21	5.26	1	EPA SW-846 8270C	02/08/2012 07:46	02/09/2012 00:52	TD
85-68-7	Benzyl butyl phthalate	ND		ug/L	2.42	5.26	1	EPA SW-846 8270C	02/08/2012 07:46	02/09/2012 00:52	TD
111-91-1	Bis(2-chloroethoxy)methane	ND		ug/L	5.10	5.26	1	EPA SW-846 8270C	02/08/2012 07:46	02/09/2012 00:52	TD
111-44-4	Bis(2-chloroethyl)ether	ND		ug/L	4.34	5.26	1	EPA SW-846 8270C	02/08/2012 07:46	02/09/2012 00:52	TD
108-60-1	Bis(2-chloroisopropyl)ether	ND		ug/L	4.37	5.26	1	EPA SW-846 8270C	02/08/2012 07:46	02/09/2012 00:52	TD
117-81-7	Bis(2-ethylhexyl)phthalate	ND		ug/L	2.71	5.26	1	EPA SW-846 8270C	02/08/2012 07:46	02/09/2012 00:52	TD
218-01-9	Chrysene	ND		ug/L	4.37	5.26	1	EPA SW-846 8270C	02/08/2012 07:46	02/09/2012 00:52	TD
53-70-3	Dibenzo(a,h)anthracene	ND		ug/L	3.26	5.26	1	EPA SW-846 8270C	02/08/2012 07:46	02/09/2012 00:52	TD
132-64-9	Dibenzofuran	ND		ug/L	3.05	5.26	1	EPA SW-846 8270C	02/08/2012 07:46	02/09/2012 00:52	TD
84-66-2	Diethyl phthalate	ND		ug/L	2.32	5.26	1	EPA SW-846 8270C	02/08/2012 07:46	02/09/2012 00:52	TD
131-11-3	Dimethyl phthalate	ND		ug/L	5.10	5.26	1	EPA SW-846 8270C	02/08/2012 07:46	02/09/2012 00:52	TD
2	Di-n-butyl phthalate	ND		ug/L	4.34	5.26	1	EPA SW-846 8270C	02/08/2012 07:46	02/09/2012 00:52	TD
117-84-0	Di-n-octyl phthalate	ND		ug/L	4.37	5.26	1	EPA SW-846 8270C	02/08/2012 07:46	02/09/2012 00:52	TD
206-44-0	Fluoranthene	ND		ug/L	1.68	5.26	1	EPA SW-846 8270C	02/08/2012 07:46	02/09/2012 00:52	TD
86-73-7	Fluorene	ND		ug/L	3.39	5.26	1	EPA SW-846 8270C	02/08/2012 07:46	02/09/2012 00:52	TD
118-74-1	Hexachlorobenzene	ND		ug/L	3.11	5.26	1	EPA SW-846 8270C	02/08/2012 07:46	02/09/2012 00:52	TD
87-68-3	Hexachlorobutadiene	ND		ug/L	3.48	5.26	1	EPA SW-846 8270C	02/08/2012 07:46	02/09/2012 00:52	TD
77-47-4	Hexachlorocyclopentadiene	ND		ug/L	3.63	5.26	1	EPA SW-846 8270C	02/08/2012 07:46	02/09/2012 00:52	TD
67-72-1	Hexachloroethane	ND		ug/L	3.82	5.26	1	EPA SW-846 8270C	02/08/2012 07:46	02/09/2012 00:52	TD
193-39-5	Indeno(1,2,3-cd)pyrene	ND		ug/L	2.89	5.26	1	EPA SW-846 8270C	02/08/2012 07:46	02/09/2012 00:52	TD
78-59-1	Isophorone	ND		ug/L	3.40	5.26	1	EPA SW-846 8270C	02/08/2012 07:46	02/09/2012 00:52	TD
91-20-3	Naphthalene	ND		ug/L	4.07	5.26	1	EPA SW-846 8270C	02/08/2012 07:46	02/09/2012 00:52	TD
98-95-3	Nitrobenzene	ND		ug/L	2.07	5.26	1	EPA SW-846 8270C	02/08/2012 07:46	02/09/2012 00:52	TD
62-75-9	N-Nitrosodimethylamine	ND		ug/L	3.27	5.26	1	EPA SW-846 8270C	02/08/2012 07:46	02/09/2012 00:52	TD
621-64-7	N-nitroso-di-n-propylamine	ND		ug/L	2.71	5.26	1	EPA SW-846 8270C	02/08/2012 07:46	02/09/2012 00:52	TD
86-30-6	N-Nitrosodiphenylamine	ND		ug/L	3.81	5.26	1	EPA SW-846 8270C	02/08/2012 07:46	02/09/2012 00:52	TD
87-86-5	Pentachlorophenol	ND		ug/L	3.96	5.26	1	EPA SW-846 8270C	02/08/2012 07:46	02/09/2012 00:52	TD
85-01-8	Phenanthrene	ND		ug/L	3.80	5.26	1	EPA SW-846 8270C	02/08/2012 07:46	02/09/2012 00:52	TD
108-95-2	Phenol	ND		ug/L	3.44	5.26	1	EPA SW-846 8270C	02/08/2012 07:46	02/09/2012 00:52	TD
129-00-0	Pyrene	ND		ug/L	2.49	5.26	1	EPA SW-846 8270C	02/08/2012 07:46	02/09/2012 00:52	TD
6-1	Pyridine	ND		ug/L	3.35	5.26	1	EPA SW-846 8270C	02/08/2012 07:46	02/09/2012 00:52	TD

YORK

ANALYTICAL LABORATORIES, INC.

Sample Information

Client Sample ID: 515W18-SB/MW224-GW

York Sample ID: 12B0219-08

York Project (SDG) No.
12B0219

Client Project ID
515 West 18th St.

Matrix
Water

Collection Date/Time
February 6, 2012 3:00 pm

Date Received
02/07/2012

Volatile Organics, 8260 List

Log-in Notes:

Sample Notes:

Sample Prepared by Method: EPA 5030B

CAS No.	Parameter	Result	Flag	Units	MDL	RL	Dilution	Reference Method	Date/Time Prepared	Date/Time Analyzed	Analyst
630-20-6	1,1,1,2-Tetrachloroethane	ND		ug/L	0.54	5.0	1	EPA SW846-8260B	02/13/2012 12:01	02/13/2012 12:28	SS
71-55-6	1,1,1-Trichloroethane	ND		ug/L	0.95	5.0	1	EPA SW846-8260B	02/13/2012 12:01	02/13/2012 12:28	SS
79-34-5	1,1,2,2-Tetrachloroethane	ND		ug/L	0.57	5.0	1	EPA SW846-8260B	02/13/2012 12:01	02/13/2012 12:28	SS
76-13-1	1,1,2-Trichloro-1,2,2-trifluoroethane (Freon 113)	ND		ug/L	0.60	5.0	1	EPA SW846-8260B	02/13/2012 12:01	02/13/2012 12:28	SS
79-00-5	1,1,2-Trichloroethane	ND		ug/L	0.61	5.0	1	EPA SW846-8260B	02/13/2012 12:01	02/13/2012 12:28	SS
75-34-3	1,1-Dichloroethane	ND		ug/L	0.69	5.0	1	EPA SW846-8260B	02/13/2012 12:01	02/13/2012 12:28	SS
75-35-4	1,1-Dichloroethylene	ND		ug/L	1.3	5.0	1	EPA SW846-8260B	02/13/2012 12:01	02/13/2012 12:28	SS
563-58-6	1,1-Dichloropropylene	ND		ug/L	0.43	5.0	1	EPA SW846-8260B	02/13/2012 12:01	02/13/2012 12:28	SS
87-61-6	1,2,3-Trichlorobenzene	ND		ug/L	0.37	10	1	EPA SW846-8260B	02/13/2012 12:01	02/13/2012 12:28	SS
96-18-4	1,2,3-Trichloropropane	ND		ug/L	1.1	5.0	1	EPA SW846-8260B	02/13/2012 12:01	02/13/2012 12:28	SS
120-82-1	1,2,4-Trichlorobenzene	ND		ug/L	0.48	10	1	EPA SW846-8260B	02/13/2012 12:01	02/13/2012 12:28	SS
95-63-6	1,2,4-Trimethylbenzene	1.2	J	ug/L	0.53	5.0	1	EPA SW846-8260B	02/13/2012 12:01	02/13/2012 12:28	SS
-8	1,2-Dibromo-3-chloropropane	ND		ug/L	1.3	10	1	EPA SW846-8260B	02/13/2012 12:01	02/13/2012 12:28	SS
106-93-4	1,2-Dibromoethane	ND		ug/L	0.68	5.0	1	EPA SW846-8260B	02/13/2012 12:01	02/13/2012 12:28	SS
95-50-1	1,2-Dichlorobenzene	ND		ug/L	0.59	5.0	1	EPA SW846-8260B	02/13/2012 12:01	02/13/2012 12:28	SS
107-06-2	1,2-Dichloroethane	ND		ug/L	0.65	5.0	1	EPA SW846-8260B	02/13/2012 12:01	02/13/2012 12:28	SS
78-87-5	1,2-Dichloropropane	ND		ug/L	0.22	5.0	1	EPA SW846-8260B	02/13/2012 12:01	02/13/2012 12:28	SS
108-67-8	1,3,5-Trimethylbenzene	ND		ug/L	0.37	5.0	1	EPA SW846-8260B	02/13/2012 12:01	02/13/2012 12:28	SS
541-73-1	1,3-Dichlorobenzene	ND		ug/L	0.47	5.0	1	EPA SW846-8260B	02/13/2012 12:01	02/13/2012 12:28	SS
142-28-9	1,3-Dichloropropane	ND		ug/L	0.69	5.0	1	EPA SW846-8260B	02/13/2012 12:01	02/13/2012 12:28	SS
106-46-7	1,4-Dichlorobenzene	ND		ug/L	0.68	5.0	1	EPA SW846-8260B	02/13/2012 12:01	02/13/2012 12:28	SS
594-20-7	2,2-Dichloropropane	ND		ug/L	0.96	5.0	1	EPA SW846-8260B	02/13/2012 12:01	02/13/2012 12:28	SS
78-93-3	2-Butanone	ND		ug/L	2.6	10	1	EPA SW846-8260B	02/13/2012 12:01	02/13/2012 12:28	SS
95-49-8	2-Chlorotoluene	ND		ug/L	0.49	5.0	1	EPA SW846-8260B	02/13/2012 12:01	02/13/2012 12:28	SS
106-43-4	4-Chlorotoluene	ND		ug/L	0.49	5.0	1	EPA SW846-8260B	02/13/2012 12:01	02/13/2012 12:28	SS
67-64-1	Acetone	ND		ug/L	3.1	10	1	EPA SW846-8260B	02/13/2012 12:01	02/13/2012 12:28	SS
71-43-2	Benzene	32		ug/L	0.48	5.0	1	EPA SW846-8260B	02/13/2012 12:01	02/13/2012 12:28	SS
108-86-1	Bromobenzene	ND		ug/L	0.61	5.0	1	EPA SW846-8260B	02/13/2012 12:01	02/13/2012 12:28	SS
74-97-5	Bromochloromethane	ND		ug/L	1.3	5.0	1	EPA SW846-8260B	02/13/2012 12:01	02/13/2012 12:28	SS
75-27-4	Bromodichloromethane	ND		ug/L	0.62	5.0	1	EPA SW846-8260B	02/13/2012 12:01	02/13/2012 12:28	SS
75-25-2	Bromoform	ND		ug/L	0.58	5.0	1	EPA SW846-8260B	02/13/2012 12:01	02/13/2012 12:28	SS
-9	Bromomethane	ND		ug/L	1.2	5.0	1	EPA SW846-8260B	02/13/2012 12:01	02/13/2012 12:28	SS
56-23-5	Carbon tetrachloride	ND		ug/L	1.0	5.0	1	EPA SW846-8260B	02/13/2012 12:01	02/13/2012 12:28	SS
108-90-7	Chlorobenzene	ND		ug/L	0.35	5.0	1	EPA SW846-8260B	02/13/2012 12:01	02/13/2012 12:28	SS

YORK

ANALYTICAL LABORATORIES, INC.

Sample Information

Client Sample ID: 515W18-SB/MW224-GW

York Sample ID: 12B0219-08

York Project (SDG) No.
12B0219

Client Project ID
515 West 18th St.

Matrix
Water

Collection Date/Time
February 6, 2012 3:00 pm

Date Received
02/07/2012

Volatile Organics, 8260 List

Log-in Notes:

Sample Notes:

Sample Prepared by Method: EPA 5030B

CAS No.	Parameter	Result	Flag	Units	MDL	RL	Dilution	Reference Method	Date/Time Prepared	Date/Time Analyzed	Analyst
75-00-3	Chloroethane	ND		ug/L	0.76	5.0	1	EPA SW846-8260B	02/13/2012 12:01	02/13/2012 12:28	SS
67-66-3	Chloroform	ND		ug/L	0.36	5.0	1	EPA SW846-8260B	02/13/2012 12:01	02/13/2012 12:28	SS
74-87-3	Chloromethane	ND		ug/L	0.89	5.0	1	EPA SW846-8260B	02/13/2012 12:01	02/13/2012 12:28	SS
156-59-2	cis-1,2-Dichloroethylene	ND		ug/L	0.96	5.0	1	EPA SW846-8260B	02/13/2012 12:01	02/13/2012 12:28	SS
10061-01-5	cis-1,3-Dichloropropylene	ND		ug/L	0.35	5.0	1	EPA SW846-8260B	02/13/2012 12:01	02/13/2012 12:28	SS
124-48-1	Dibromochloromethane	ND		ug/L	0.67	5.0	1	EPA SW846-8260B	02/13/2012 12:01	02/13/2012 12:28	SS
74-95-3	Dibromomethane	ND		ug/L	1.3	5.0	1	EPA SW846-8260B	02/13/2012 12:01	02/13/2012 12:28	SS
75-71-8	Dichlorodifluoromethane	ND		ug/L	0.83	5.0	1	EPA SW846-8260B	02/13/2012 12:01	02/13/2012 12:28	SS
100-41-4	Ethyl Benzene	ND		ug/L	0.35	5.0	1	EPA SW846-8260B	02/13/2012 12:01	02/13/2012 12:28	SS
87-68-3	Hexachlorobutadiene	ND		ug/L	0.43	5.0	1	EPA SW846-8260B	02/13/2012 12:01	02/13/2012 12:28	SS
98-82-8	Isopropylbenzene	21		ug/L	0.39	5.0	1	EPA SW846-8260B	02/13/2012 12:01	02/13/2012 12:28	SS
1634-04-4	Methyl tert-butyl ether (MTBE)	ND		ug/L	0.38	5.0	1	EPA SW846-8260B	02/13/2012 12:01	02/13/2012 12:28	SS
75-28-2	Methylene chloride	2.3	J, B	ug/L	1.1	10	1	EPA SW846-8260B	02/13/2012 12:01	02/13/2012 12:28	SS
149-30-3	Naphthalene	4.9	J	ug/L	0.50	10	1	EPA SW846-8260B	02/13/2012 12:01	02/13/2012 12:28	SS
104-51-8	n-Butylbenzene	6.3		ug/L	0.32	5.0	1	EPA SW846-8260B	02/13/2012 12:01	02/13/2012 12:28	SS
103-65-1	n-Propylbenzene	39		ug/L	0.58	5.0	1	EPA SW846-8260B	02/13/2012 12:01	02/13/2012 12:28	SS
95-47-6	o-Xylene	1.2	J	ug/L	0.50	5.0	1	EPA SW846-8260B	02/13/2012 12:01	02/13/2012 12:28	SS
1330-20-7P/M	p- & m- Xylenes	3.2	J	ug/L	0.55	10	1	EPA SW846-8260B	02/13/2012 12:01	02/13/2012 12:28	SS
99-87-6	p-Isopropyltoluene	ND		ug/L	0.25	5.0	1	EPA SW846-8260B	02/13/2012 12:01	02/13/2012 12:28	SS
135-98-8	sec-Butylbenzene	5.2		ug/L	0.52	5.0	1	EPA SW846-8260B	02/13/2012 12:01	02/13/2012 12:28	SS
100-42-5	Styrene	ND		ug/L	0.43	5.0	1	EPA SW846-8260B	02/13/2012 12:01	02/13/2012 12:28	SS
98-06-6	tert-Butylbenzene	ND		ug/L	0.46	5.0	1	EPA SW846-8260B	02/13/2012 12:01	02/13/2012 12:28	SS
127-18-4	Tetrachloroethylene	ND		ug/L	0.52	5.0	1	EPA SW846-8260B	02/13/2012 12:01	02/13/2012 12:28	SS
108-88-3	Toluene	2.3	J	ug/L	0.23	5.0	1	EPA SW846-8260B	02/13/2012 12:01	02/13/2012 12:28	SS
156-60-5	trans-1,2-Dichloroethylene	ND		ug/L	0.65	5.0	1	EPA SW846-8260B	02/13/2012 12:01	02/13/2012 12:28	SS
10061-02-6	trans-1,3-Dichloropropylene	ND		ug/L	0.68	5.0	1	EPA SW846-8260B	02/13/2012 12:01	02/13/2012 12:28	SS
79-01-6	Trichloroethylene	ND		ug/L	0.57	5.0	1	EPA SW846-8260B	02/13/2012 12:01	02/13/2012 12:28	SS
75-69-4	Trichlorofluoromethane	ND		ug/L	0.91	5.0	1	EPA SW846-8260B	02/13/2012 12:01	02/13/2012 12:28	SS
75-01-4	Vinyl Chloride	ND		ug/L	0.97	5.0	1	EPA SW846-8260B	02/13/2012 12:01	02/13/2012 12:28	SS
1330-20-7	Xylenes, Total	4.4	J	ug/L	1.0	15	1	EPA SW846-8260B	02/13/2012 12:01	02/13/2012 12:28	SS

YORK

ANALYTICAL LABORATORIES, INC.

Sample Information

Client Sample ID: 515W18-SB/MW224-GW

York Sample ID: 12B0219-08

York Project (SDG) No.
12B0219

Client Project ID
515 West 18th St.

Matrix
Water

Collection Date/Time
February 6, 2012 3:00 pm

Date Received
02/07/2012

Semi-Volatiles, 8270 Target List

Log-in Notes:

Sample Notes: EXT-EM

Sample Prepared by Method: EPA 3510C

CAS No.	Parameter	Result	Flag	Units	MDL	RL	Dilution	Reference Method	Date/Time Prepared	Date/Time Analyzed	Analyst
120-82-1	1,2,4-Trichlorobenzene	ND		ug/L	1.35	5.13	1	EPA SW-846 8270C	02/08/2012 07:46	02/09/2012 01:23	TD
95-50-1	1,2-Dichlorobenzene	ND		ug/L	1.68	5.13	1	EPA SW-846 8270C	02/08/2012 07:46	02/09/2012 01:23	TD
541-73-1	1,3-Dichlorobenzene	ND		ug/L	2.82	5.13	1	EPA SW-846 8270C	02/08/2012 07:46	02/09/2012 01:23	TD
106-46-7	1,4-Dichlorobenzene	ND		ug/L	3.31	5.13	1	EPA SW-846 8270C	02/08/2012 07:46	02/09/2012 01:23	TD
95-95-4	2,4,5-Trichlorophenol	ND		ug/L	3.70	5.13	1	EPA SW-846 8270C	02/08/2012 07:46	02/09/2012 01:23	TD
88-06-2	2,4,6-Trichlorophenol	ND		ug/L	3.36	5.13	1	EPA SW-846 8270C	02/08/2012 07:46	02/09/2012 01:23	TD
120-83-2	2,4-Dichlorophenol	ND		ug/L	3.17	5.13	1	EPA SW-846 8270C	02/08/2012 07:46	02/09/2012 01:23	TD
105-67-9	2,4-Dimethylphenol	ND		ug/L	3.78	5.13	1	EPA SW-846 8270C	02/08/2012 07:46	02/09/2012 01:23	TD
51-28-5	2,4-Dinitrophenol	ND		ug/L	9.85	10.3	1	EPA SW-846 8270C	02/08/2012 07:46	02/09/2012 01:23	TD
121-14-2	2,4-Dinitrotoluene	ND		ug/L	2.43	5.13	1	EPA SW-846 8270C	02/08/2012 07:46	02/09/2012 01:23	TD
606-20-2	2,6-Dinitrotoluene	ND		ug/L	3.60	5.13	1	EPA SW-846 8270C	02/08/2012 07:46	02/09/2012 01:23	TD
91-58-7	2-Chloronaphthalene	ND		ug/L	3.58	5.13	1	EPA SW-846 8270C	02/08/2012 07:46	02/09/2012 01:23	TD
7-8	2-Chlorophenol	ND		ug/L	3.50	5.13	1	EPA SW-846 8270C	02/08/2012 07:46	02/09/2012 01:23	TD
51-57-6	2-Methylnaphthalene	17.8		ug/L	3.15	5.13	1	EPA SW-846 8270C	02/08/2012 07:46	02/09/2012 01:23	TD
95-48-7	2-Methylphenol	ND		ug/L	0.879	5.13	1	EPA SW-846 8270C	02/08/2012 07:46	02/09/2012 01:23	TD
88-74-4	2-Nitroaniline	ND		ug/L	3.08	5.13	1	EPA SW-846 8270C	02/08/2012 07:46	02/09/2012 01:23	TD
88-75-5	2-Nitrophenol	ND		ug/L	3.18	5.13	1	EPA SW-846 8270C	02/08/2012 07:46	02/09/2012 01:23	TD
100-01-6	3- & 4-Methylphenols	ND		ug/L	3.81	5.13	1	EPA SW-846 8270C	02/08/2012 07:46	02/09/2012 01:23	TD
91-94-1	3,3'-Dichlorobenzidine	ND		ug/L	3.60	5.13	1	EPA SW-846 8270C	02/08/2012 07:46	02/09/2012 01:23	TD
99-09-2	3-Nitroaniline	ND		ug/L	1.64	5.13	1	EPA SW-846 8270C	02/08/2012 07:46	02/09/2012 01:23	TD
534-52-1	4,6-Dinitro-2-methylphenol	ND		ug/L	6.87	10.3	1	EPA SW-846 8270C	02/08/2012 07:46	02/09/2012 01:23	TD
101-55-3	4-Bromophenyl phenyl ether	ND		ug/L	3.53	5.13	1	EPA SW-846 8270C	02/08/2012 07:46	02/09/2012 01:23	TD
59-50-7	4-Chloro-3-methylphenol	ND		ug/L	3.72	5.13	1	EPA SW-846 8270C	02/08/2012 07:46	02/09/2012 01:23	TD
106-47-8	4-Chloroaniline	ND		ug/L	3.84	5.13	1	EPA SW-846 8270C	02/08/2012 07:46	02/09/2012 01:23	TD
7005-72-3	4-Chlorophenyl phenyl ether	ND		ug/L	3.20	5.13	1	EPA SW-846 8270C	02/08/2012 07:46	02/09/2012 01:23	TD
100-02-7	4-Nitroaniline	ND		ug/L	3.87	5.13	1	EPA SW-846 8270C	02/08/2012 07:46	02/09/2012 01:23	TD
56-57-5	4-Nitrophenol	ND		ug/L	4.04	5.13	1	EPA SW-846 8270C	02/08/2012 07:46	02/09/2012 01:23	TD
83-32-9	Acenaphthene	ND		ug/L	3.32	5.13	1	EPA SW-846 8270C	02/08/2012 07:46	02/09/2012 01:23	TD
208-96-8	Acenaphthylene	ND		ug/L	4.38	5.13	1	EPA SW-846 8270C	02/08/2012 07:46	02/09/2012 01:23	TD
62-53-3	Aniline	ND		ug/L	2.02	5.13	1	EPA SW-846 8270C	02/08/2012 07:46	02/09/2012 01:23	TD
120-12-7	Anthracene	ND		ug/L	3.75	5.13	1	EPA SW-846 8270C	02/08/2012 07:46	02/09/2012 01:23	TD
15-3	Benzo(a)anthracene	ND		ug/L	4.17	5.13	1	EPA SW-846 8270C	02/08/2012 07:46	02/09/2012 01:23	TD
129-32-8	Benzo(a)pyrene	ND		ug/L	4.97	5.13	1	EPA SW-846 8270C	02/08/2012 07:46	02/09/2012 01:23	TD
205-99-2	Benzo(b)fluoranthene	ND		ug/L	4.23	5.13	1	EPA SW-846 8270C	02/08/2012 07:46	02/09/2012 01:23	TD
191-24-2	Benzo(g,h,i)perylene	ND		ug/L	4.26	5.13	1	EPA SW-846 8270C	02/08/2012 07:46	02/09/2012 01:23	TD

YORK

ANALYTICAL LABORATORIES, INC.

Sample Information

Client Sample ID: 515W18-SB/MW224-GW

York Sample ID: 12B0219-08

York Project (SDG) No.
12B0219

Client Project ID
515 West 18th St.

Matrix
Water

Collection Date/Time
February 6, 2012 3:00 pm

Date Received
02/07/2012

Semi-Volatiles, 8270 Target List

Log-in Notes:

Sample Notes: EXT-EM

Sample Prepared by Method: EPA 3510C

CAS No.	Parameter	Result	Flag	Units	MDL	RL	Dilution	Reference Method	Date/Time Prepared	Date/Time Analyzed	Analyst
207-08-9	Benzo(k)fluoranthene	ND		ug/L	3.54	5.13	1	EPA SW-846 8270C	02/08/2012 07:46	02/09/2012 01:23	TD
100-51-6	Benzyl alcohol	ND		ug/L	4.10	5.13	1	EPA SW-846 8270C	02/08/2012 07:46	02/09/2012 01:23	TD
85-68-7	Benzyl butyl phthalate	ND		ug/L	2.36	5.13	1	EPA SW-846 8270C	02/08/2012 07:46	02/09/2012 01:23	TD
111-91-1	Bis(2-chloroethoxy)methane	ND		ug/L	4.97	5.13	1	EPA SW-846 8270C	02/08/2012 07:46	02/09/2012 01:23	TD
111-44-4	Bis(2-chloroethyl)ether	ND		ug/L	4.23	5.13	1	EPA SW-846 8270C	02/08/2012 07:46	02/09/2012 01:23	TD
108-60-1	Bis(2-chloroisopropyl)ether	ND		ug/L	4.26	5.13	1	EPA SW-846 8270C	02/08/2012 07:46	02/09/2012 01:23	TD
117-81-7	Bis(2-ethylhexyl)phthalate	ND		ug/L	2.64	5.13	1	EPA SW-846 8270C	02/08/2012 07:46	02/09/2012 01:23	TD
218-01-9	Chrysene	ND		ug/L	4.26	5.13	1	EPA SW-846 8270C	02/08/2012 07:46	02/09/2012 01:23	TD
53-70-3	Dibenzo(a,h)anthracene	ND		ug/L	3.18	5.13	1	EPA SW-846 8270C	02/08/2012 07:46	02/09/2012 01:23	TD
132-64-9	Dibenzofuran	ND		ug/L	2.97	5.13	1	EPA SW-846 8270C	02/08/2012 07:46	02/09/2012 01:23	TD
84-66-2	Diethyl phthalate	ND		ug/L	2.26	5.13	1	EPA SW-846 8270C	02/08/2012 07:46	02/09/2012 01:23	TD
131-11-3	Dimethyl phthalate	ND		ug/L	4.97	5.13	1	EPA SW-846 8270C	02/08/2012 07:46	02/09/2012 01:23	TD
-2	Di-n-butyl phthalate	ND		ug/L	4.23	5.13	1	EPA SW-846 8270C	02/08/2012 07:46	02/09/2012 01:23	TD
117-84-0	Di-n-octyl phthalate	ND		ug/L	4.26	5.13	1	EPA SW-846 8270C	02/08/2012 07:46	02/09/2012 01:23	TD
206-44-0	Fluoranthene	ND		ug/L	1.64	5.13	1	EPA SW-846 8270C	02/08/2012 07:46	02/09/2012 01:23	TD
86-73-7	Fluorene	ND		ug/L	3.31	5.13	1	EPA SW-846 8270C	02/08/2012 07:46	02/09/2012 01:23	TD
118-74-1	Hexachlorobenzene	ND		ug/L	3.03	5.13	1	EPA SW-846 8270C	02/08/2012 07:46	02/09/2012 01:23	TD
87-68-3	Hexachlorobutadiene	ND		ug/L	3.39	5.13	1	EPA SW-846 8270C	02/08/2012 07:46	02/09/2012 01:23	TD
77-47-4	Hexachlorocyclopentadiene	ND		ug/L	3.53	5.13	1	EPA SW-846 8270C	02/08/2012 07:46	02/09/2012 01:23	TD
67-72-1	Hexachloroethane	ND		ug/L	3.72	5.13	1	EPA SW-846 8270C	02/08/2012 07:46	02/09/2012 01:23	TD
193-39-5	Indeno(1,2,3-cd)pyrene	ND		ug/L	2.82	5.13	1	EPA SW-846 8270C	02/08/2012 07:46	02/09/2012 01:23	TD
78-59-1	Isophorone	ND		ug/L	3.31	5.13	1	EPA SW-846 8270C	02/08/2012 07:46	02/09/2012 01:23	TD
91-20-3	Naphthalene	ND		ug/L	3.96	5.13	1	EPA SW-846 8270C	02/08/2012 07:46	02/09/2012 01:23	TD
98-95-3	Nitrobenzene	ND		ug/L	2.02	5.13	1	EPA SW-846 8270C	02/08/2012 07:46	02/09/2012 01:23	TD
62-75-9	N-Nitrosodimethylamine	ND		ug/L	3.18	5.13	1	EPA SW-846 8270C	02/08/2012 07:46	02/09/2012 01:23	TD
621-64-7	N-nitroso-di-n-propylamine	ND		ug/L	2.64	5.13	1	EPA SW-846 8270C	02/08/2012 07:46	02/09/2012 01:23	TD
86-30-6	N-Nitrosodiphenylamine	ND		ug/L	3.71	5.13	1	EPA SW-846 8270C	02/08/2012 07:46	02/09/2012 01:23	TD
87-86-5	Pentachlorophenol	ND		ug/L	3.86	5.13	1	EPA SW-846 8270C	02/08/2012 07:46	02/09/2012 01:23	TD
85-01-8	Phenanthrene	ND		ug/L	3.70	5.13	1	EPA SW-846 8270C	02/08/2012 07:46	02/09/2012 01:23	TD
108-95-2	Phenol	ND		ug/L	3.36	5.13	1	EPA SW-846 8270C	02/08/2012 07:46	02/09/2012 01:23	TD
129-00-0	Pyrene	ND		ug/L	2.43	5.13	1	EPA SW-846 8270C	02/08/2012 07:46	02/09/2012 01:23	TD
16-1	Pyridine	ND		ug/L	3.27	5.13	1	EPA SW-846 8270C	02/08/2012 07:46	02/09/2012 01:23	TD

YORK

ANALYTICAL LABORATORIES, INC.

Sample Information

Client Sample ID: 515W18-SB/MW7A-GW

York Sample ID: 12B0219-09

York Project (SDG) No.

Client Project ID

Matrix

Collection Date/Time

Date Received

12B0219

515 West 18th St.

Water

February 6, 2012 3:00 pm

02/07/2012

Volatile Organics, 8260 List

Log-in Notes:

Sample Notes:

Sample Prepared by Method: EPA 5030B

CAS No.	Parameter	Result	Flag	Units	MDL	RL	Dilution	Reference Method	Date/Time Prepared	Date/Time Analyzed	Analyst
630-20-6	1,1,1,2-Tetrachloroethane	ND		ug/L	0.54	5.0	1	EPA SW846-8260B	02/09/2012 15:14	02/10/2012 08:06	SS
71-55-6	1,1,1-Trichloroethane	ND		ug/L	0.95	5.0	1	EPA SW846-8260B	02/09/2012 15:14	02/10/2012 08:06	SS
79-34-5	1,1,2,2-Tetrachloroethane	ND		ug/L	0.57	5.0	1	EPA SW846-8260B	02/09/2012 15:14	02/10/2012 08:06	SS
76-13-1	1,1,2-Trichloro-1,2,2-trifluoroethane (Freon 113)	ND		ug/L	0.60	5.0	1	EPA SW846-8260B	02/09/2012 15:14	02/10/2012 08:06	SS
79-00-5	1,1,2-Trichloroethane	ND		ug/L	0.61	5.0	1	EPA SW846-8260B	02/09/2012 15:14	02/10/2012 08:06	SS
75-34-3	1,1-Dichloroethane	ND		ug/L	0.69	5.0	1	EPA SW846-8260B	02/09/2012 15:14	02/10/2012 08:06	SS
75-35-4	1,1-Dichloroethylene	ND		ug/L	1.3	5.0	1	EPA SW846-8260B	02/09/2012 15:14	02/10/2012 08:06	SS
563-58-6	1,1-Dichloropropylene	ND		ug/L	0.43	5.0	1	EPA SW846-8260B	02/09/2012 15:14	02/10/2012 08:06	SS
87-61-6	1,2,3-Trichlorobenzene	ND		ug/L	0.37	10	1	EPA SW846-8260B	02/09/2012 15:14	02/10/2012 08:06	SS
96-18-4	1,2,3-Trichloropropane	ND		ug/L	1.1	5.0	1	EPA SW846-8260B	02/09/2012 15:14	02/10/2012 08:06	SS
120-82-1	1,2,4-Trichlorobenzene	ND		ug/L	0.48	10	1	EPA SW846-8260B	02/09/2012 15:14	02/10/2012 08:06	SS
95-63-6	1,2,4-Trimethylbenzene	ND		ug/L	0.53	5.0	1	EPA SW846-8260B	02/09/2012 15:14	02/10/2012 08:06	SS
2-8	1,2-Dibromo-3-chloropropane	ND		ug/L	1.3	10	1	EPA SW846-8260B	02/09/2012 15:14	02/10/2012 08:06	SS
106-93-4	1,2-Dibromoethane	ND		ug/L	0.68	5.0	1	EPA SW846-8260B	02/09/2012 15:14	02/10/2012 08:06	SS
95-50-1	1,2-Dichlorobenzene	ND		ug/L	0.59	5.0	1	EPA SW846-8260B	02/09/2012 15:14	02/10/2012 08:06	SS
107-06-2	1,2-Dichloroethane	ND		ug/L	0.65	5.0	1	EPA SW846-8260B	02/09/2012 15:14	02/10/2012 08:06	SS
78-87-5	1,2-Dichloropropane	ND		ug/L	0.22	5.0	1	EPA SW846-8260B	02/09/2012 15:14	02/10/2012 08:06	SS
108-67-8	1,3,5-Trimethylbenzene	ND		ug/L	0.37	5.0	1	EPA SW846-8260B	02/09/2012 15:14	02/10/2012 08:06	SS
541-73-1	1,3-Dichlorobenzene	ND		ug/L	0.47	5.0	1	EPA SW846-8260B	02/09/2012 15:14	02/10/2012 08:06	SS
142-28-9	1,3-Dichloropropane	ND		ug/L	0.69	5.0	1	EPA SW846-8260B	02/09/2012 15:14	02/10/2012 08:06	SS
106-46-7	1,4-Dichlorobenzene	ND		ug/L	0.68	5.0	1	EPA SW846-8260B	02/09/2012 15:14	02/10/2012 08:06	SS
594-20-7	2,2-Dichloropropane	ND		ug/L	0.96	5.0	1	EPA SW846-8260B	02/09/2012 15:14	02/10/2012 08:06	SS
78-93-3	2-Butanone	ND		ug/L	2.6	10	1	EPA SW846-8260B	02/09/2012 15:14	02/10/2012 08:06	SS
95-49-8	2-Chlorotoluene	ND		ug/L	0.49	5.0	1	EPA SW846-8260B	02/09/2012 15:14	02/10/2012 08:06	SS
106-43-4	4-Chlorotoluene	ND		ug/L	0.49	5.0	1	EPA SW846-8260B	02/09/2012 15:14	02/10/2012 08:06	SS
67-64-1	Acetone	8.2	B, J	ug/L	3.1	10	1	EPA SW846-8260B	02/09/2012 15:14	02/10/2012 08:06	SS
71-43-2	Benzene	23		ug/L	0.48	5.0	1	EPA SW846-8260B	02/09/2012 15:14	02/10/2012 08:06	SS
108-86-1	Bromobenzene	ND		ug/L	0.61	5.0	1	EPA SW846-8260B	02/09/2012 15:14	02/10/2012 08:06	SS
74-97-5	Bromochloromethane	ND		ug/L	1.3	5.0	1	EPA SW846-8260B	02/09/2012 15:14	02/10/2012 08:06	SS
75-27-4	Bromodichloromethane	ND		ug/L	0.62	5.0	1	EPA SW846-8260B	02/09/2012 15:14	02/10/2012 08:06	SS
75-25-2	Bromoform	ND		ug/L	0.58	5.0	1	EPA SW846-8260B	02/09/2012 15:14	02/10/2012 08:06	SS
3-9	Bromomethane	ND		ug/L	1.2	5.0	1	EPA SW846-8260B	02/09/2012 15:14	02/10/2012 08:06	SS
56-23-5	Carbon tetrachloride	ND		ug/L	1.0	5.0	1	EPA SW846-8260B	02/09/2012 15:14	02/10/2012 08:06	SS
108-90-7	Chlorobenzene	ND		ug/L	0.35	5.0	1	EPA SW846-8260B	02/09/2012 15:14	02/10/2012 08:06	SS

YORK

ANALYTICAL LABORATORIES, INC.

Sample Information

Client Sample ID: 515W18-SB/MW7A-GW

York Sample ID: 12B0219-09

York Project (SDG) No.
12B0219

Client Project ID
515 West 18th St.

Matrix
Water

Collection Date/Time
February 6, 2012 3:00 pm

Date Received
02/07/2012

Volatiles Organics, 8260 List

Log-in Notes:

Sample Notes:

Sample Prepared by Method: EPA 5030B

CAS No.	Parameter	Result	Flag	Units	MDL	RL	Dilution	Reference Method	Date/Time Prepared	Date/Time Analyzed	Analyst
75-00-3	Chloroethane	ND		ug/L	0.76	5.0	1	EPA SW846-8260B	02/09/2012 15:14	02/10/2012 08:06	SS
67-66-3	Chloroform	ND		ug/L	0.36	5.0	1	EPA SW846-8260B	02/09/2012 15:14	02/10/2012 08:06	SS
74-87-3	Chloromethane	ND		ug/L	0.89	5.0	1	EPA SW846-8260B	02/09/2012 15:14	02/10/2012 08:06	SS
156-59-2	cis-1,2-Dichloroethylene	ND		ug/L	0.96	5.0	1	EPA SW846-8260B	02/09/2012 15:14	02/10/2012 08:06	SS
10061-01-5	cis-1,3-Dichloropropylene	ND		ug/L	0.35	5.0	1	EPA SW846-8260B	02/09/2012 15:14	02/10/2012 08:06	SS
124-48-1	Dibromochloromethane	ND		ug/L	0.67	5.0	1	EPA SW846-8260B	02/09/2012 15:14	02/10/2012 08:06	SS
74-95-3	Dibromomethane	ND		ug/L	1.3	5.0	1	EPA SW846-8260B	02/09/2012 15:14	02/10/2012 08:06	SS
75-71-8	Dichlorodifluoromethane	ND		ug/L	0.83	5.0	1	EPA SW846-8260B	02/09/2012 15:14	02/10/2012 08:06	SS
100-41-4	Ethyl Benzene	ND		ug/L	0.35	5.0	1	EPA SW846-8260B	02/09/2012 15:14	02/10/2012 08:06	SS
87-68-3	Hexachlorobutadiene	ND		ug/L	0.43	5.0	1	EPA SW846-8260B	02/09/2012 15:14	02/10/2012 08:06	SS
98-82-8	Isopropylbenzene	0.87	J	ug/L	0.39	5.0	1	EPA SW846-8260B	02/09/2012 15:14	02/10/2012 08:06	SS
1634-04-4	Methyl tert-butyl ether (MTBE)	ND		ug/L	0.38	5.0	1	EPA SW846-8260B	02/09/2012 15:14	02/10/2012 08:06	SS
75-29-2	Methylene chloride	4.6	B, J	ug/L	1.1	10	1	EPA SW846-8260B	02/09/2012 15:14	02/10/2012 08:06	SS
123-20-3	Naphthalene	ND		ug/L	0.50	10	1	EPA SW846-8260B	02/09/2012 15:14	02/10/2012 08:06	SS
104-51-8	n-Butylbenzene	ND		ug/L	0.32	5.0	1	EPA SW846-8260B	02/09/2012 15:14	02/10/2012 08:06	SS
103-65-1	n-Propylbenzene	ND		ug/L	0.58	5.0	1	EPA SW846-8260B	02/09/2012 15:14	02/10/2012 08:06	SS
95-47-6	o-Xylene	ND		ug/L	0.50	5.0	1	EPA SW846-8260B	02/09/2012 15:14	02/10/2012 08:06	SS
1330-20-7P/M	p- & m- Xylenes	ND		ug/L	0.55	10	1	EPA SW846-8260B	02/09/2012 15:14	02/10/2012 08:06	SS
99-87-6	p-Isopropyltoluene	ND		ug/L	0.25	5.0	1	EPA SW846-8260B	02/09/2012 15:14	02/10/2012 08:06	SS
135-98-8	sec-Butylbenzene	ND		ug/L	0.52	5.0	1	EPA SW846-8260B	02/09/2012 15:14	02/10/2012 08:06	SS
100-42-5	Styrene	ND		ug/L	0.43	5.0	1	EPA SW846-8260B	02/09/2012 15:14	02/10/2012 08:06	SS
98-06-6	tert-Butylbenzene	ND		ug/L	0.46	5.0	1	EPA SW846-8260B	02/09/2012 15:14	02/10/2012 08:06	SS
127-18-4	Tetrachloroethylene	ND		ug/L	0.52	5.0	1	EPA SW846-8260B	02/09/2012 15:14	02/10/2012 08:06	SS
108-88-3	Toluene	ND		ug/L	0.23	5.0	1	EPA SW846-8260B	02/09/2012 15:14	02/10/2012 08:06	SS
156-60-5	trans-1,2-Dichloroethylene	ND		ug/L	0.65	5.0	1	EPA SW846-8260B	02/09/2012 15:14	02/10/2012 08:06	SS
10061-02-6	trans-1,3-Dichloropropylene	ND		ug/L	0.68	5.0	1	EPA SW846-8260B	02/09/2012 15:14	02/10/2012 08:06	SS
79-01-6	Trichloroethylene	ND		ug/L	0.57	5.0	1	EPA SW846-8260B	02/09/2012 15:14	02/10/2012 08:06	SS
75-69-4	Trichlorofluoromethane	ND		ug/L	0.91	5.0	1	EPA SW846-8260B	02/09/2012 15:14	02/10/2012 08:06	SS
75-01-4	Vinyl Chloride	ND		ug/L	0.97	5.0	1	EPA SW846-8260B	02/09/2012 15:14	02/10/2012 08:06	SS
1330-20-7	Xylenes, Total	ND		ug/L	1.0	15	1	EPA SW846-8260B	02/09/2012 15:14	02/10/2012 08:06	SS

YORK

ANALYTICAL LABORATORIES, INC.

Sample Information

Client Sample ID: 515W18-SB/MW7A-GW

York Sample ID: 12B0219-09

York Project (SDG) No.
12B0219

Client Project ID
515 West 18th St.

Matrix
Water

Collection Date/Time
February 6, 2012 3:00 pm

Date Received
02/07/2012

Semi-Volatiles, 8270 Target List

Log-in Notes:

Sample Notes: EXT-D

Sample Prepared by Method: EPA 3510C

CAS No.	Parameter	Result	Flag	Units	MDL	RL	Dilution	Reference Method	Date/Time Prepared	Date/Time Analyzed	Analyst
120-82-1	1,2,4-Trichlorobenzene	ND		ug/L	1.38	5.26	1	EPA SW-846 8270C	02/08/2012 07:46	02/09/2012 04:25	TD
95-50-1	1,2-Dichlorobenzene	ND		ug/L	1.72	5.26	1	EPA SW-846 8270C	02/08/2012 07:46	02/09/2012 04:25	TD
541-73-1	1,3-Dichlorobenzene	ND		ug/L	2.89	5.26	1	EPA SW-846 8270C	02/08/2012 07:46	02/09/2012 04:25	TD
106-46-7	1,4-Dichlorobenzene	ND		ug/L	3.40	5.26	1	EPA SW-846 8270C	02/08/2012 07:46	02/09/2012 04:25	TD
95-95-4	2,4,5-Trichlorophenol	ND		ug/L	3.80	5.26	1	EPA SW-846 8270C	02/08/2012 07:46	02/09/2012 04:25	TD
88-06-2	2,4,6-Trichlorophenol	ND		ug/L	3.44	5.26	1	EPA SW-846 8270C	02/08/2012 07:46	02/09/2012 04:25	TD
120-83-2	2,4-Dichlorophenol	ND		ug/L	3.25	5.26	1	EPA SW-846 8270C	02/08/2012 07:46	02/09/2012 04:25	TD
105-67-9	2,4-Dimethylphenol	ND		ug/L	3.88	5.26	1	EPA SW-846 8270C	02/08/2012 07:46	02/09/2012 04:25	TD
51-28-5	2,4-Dinitrophenol	ND		ug/L	10.1	10.5	1	EPA SW-846 8270C	02/08/2012 07:46	02/09/2012 04:25	TD
121-14-2	2,4-Dinitrotoluene	ND		ug/L	2.49	5.26	1	EPA SW-846 8270C	02/08/2012 07:46	02/09/2012 04:25	TD
606-20-2	2,6-Dinitrotoluene	ND		ug/L	3.69	5.26	1	EPA SW-846 8270C	02/08/2012 07:46	02/09/2012 04:25	TD
91-58-7	2-Chloronaphthalene	ND		ug/L	3.67	5.26	1	EPA SW-846 8270C	02/08/2012 07:46	02/09/2012 04:25	TD
7-8	2-Chlorophenol	ND		ug/L	3.60	5.26	1	EPA SW-846 8270C	02/08/2012 07:46	02/09/2012 04:25	TD
91-57-6	2-Methylnaphthalene	ND		ug/L	3.24	5.26	1	EPA SW-846 8270C	02/08/2012 07:46	02/09/2012 04:25	TD
95-48-7	2-Methylphenol	ND		ug/L	0.902	5.26	1	EPA SW-846 8270C	02/08/2012 07:46	02/09/2012 04:25	TD
88-74-4	2-Nitroaniline	ND		ug/L	3.17	5.26	1	EPA SW-846 8270C	02/08/2012 07:46	02/09/2012 04:25	TD
88-75-5	2-Nitrophenol	ND		ug/L	3.27	5.26	1	EPA SW-846 8270C	02/08/2012 07:46	02/09/2012 04:25	TD
100-01-6	3- & 4-Methylphenols	ND		ug/L	3.91	5.26	1	EPA SW-846 8270C	02/08/2012 07:46	02/09/2012 04:25	TD
91-94-1	3,3'-Dichlorobenzidine	ND		ug/L	3.70	5.26	1	EPA SW-846 8270C	02/08/2012 07:46	02/09/2012 04:25	TD
99-09-2	3-Nitroaniline	ND		ug/L	1.68	5.26	1	EPA SW-846 8270C	02/08/2012 07:46	02/09/2012 04:25	TD
534-52-1	4,6-Dinitro-2-methylphenol	ND		ug/L	7.05	10.5	1	EPA SW-846 8270C	02/08/2012 07:46	02/09/2012 04:25	TD
101-55-3	4-Bromophenyl phenyl ether	ND		ug/L	3.63	5.26	1	EPA SW-846 8270C	02/08/2012 07:46	02/09/2012 04:25	TD
59-50-7	4-Chloro-3-methylphenol	ND		ug/L	3.82	5.26	1	EPA SW-846 8270C	02/08/2012 07:46	02/09/2012 04:25	TD
106-47-8	4-Chloroaniline	ND		ug/L	3.94	5.26	1	EPA SW-846 8270C	02/08/2012 07:46	02/09/2012 04:25	TD
7005-72-3	4-Chlorophenyl phenyl ether	ND		ug/L	3.28	5.26	1	EPA SW-846 8270C	02/08/2012 07:46	02/09/2012 04:25	TD
100-02-7	4-Nitroaniline	ND		ug/L	3.97	5.26	1	EPA SW-846 8270C	02/08/2012 07:46	02/09/2012 04:25	TD
56-57-5	4-Nitrophenol	ND		ug/L	4.15	5.26	1	EPA SW-846 8270C	02/08/2012 07:46	02/09/2012 04:25	TD
83-32-9	Acenaphthene	ND		ug/L	3.41	5.26	1	EPA SW-846 8270C	02/08/2012 07:46	02/09/2012 04:25	TD
208-96-8	Acenaphthylene	ND		ug/L	4.50	5.26	1	EPA SW-846 8270C	02/08/2012 07:46	02/09/2012 04:25	TD
62-53-3	Aniline	ND		ug/L	2.07	5.26	1	EPA SW-846 8270C	02/08/2012 07:46	02/09/2012 04:25	TD
120-12-7	Anthracene	ND		ug/L	3.85	5.26	1	EPA SW-846 8270C	02/08/2012 07:46	02/09/2012 04:25	TD
15-3	Benzo(a)anthracene	ND		ug/L	4.28	5.26	1	EPA SW-846 8270C	02/08/2012 07:46	02/09/2012 04:25	TD
124-32-8	Benzo(a)pyrene	ND		ug/L	5.10	5.26	1	EPA SW-846 8270C	02/08/2012 07:46	02/09/2012 04:25	TD
205-99-2	Benzo(b)fluoranthene	ND		ug/L	4.34	5.26	1	EPA SW-846 8270C	02/08/2012 07:46	02/09/2012 04:25	TD
191-24-2	Benzo(g,h,i)perylene	ND		ug/L	4.37	5.26	1	EPA SW-846 8270C	02/08/2012 07:46	02/09/2012 04:25	TD

YORK

ANALYTICAL LABORATORIES, INC.

Sample Information

Client Sample ID: 515W18-SB/MW7A-GW

York Sample ID: 12B0219-09

York Project (SDG) No.
12B0219

Client Project ID
515 West 18th St.

Matrix
Water

Collection Date/Time
February 6, 2012 3:00 pm

Date Received
02/07/2012

Semi-Volatiles, 8270 Target List

Log-in Notes:

Sample Notes: EXT-D

Sample Prepared by Method: EPA 3510C

CAS No.	Parameter	Result	Flag	Units	MDL	RL	Dilution	Reference Method	Date/Time Prepared	Date/Time Analyzed	Analyst
207-08-9	Benzo(k)fluoranthene	ND		ug/L	3.64	5.26	1	EPA SW-846 8270C	02/08/2012 07:46	02/09/2012 04:25	TD
100-51-6	Benzyl alcohol	ND		ug/L	4.21	5.26	1	EPA SW-846 8270C	02/08/2012 07:46	02/09/2012 04:25	TD
85-68-7	Benzyl butyl phthalate	ND		ug/L	2.42	5.26	1	EPA SW-846 8270C	02/08/2012 07:46	02/09/2012 04:25	TD
111-91-1	Bis(2-chloroethoxy)methane	ND		ug/L	5.10	5.26	1	EPA SW-846 8270C	02/08/2012 07:46	02/09/2012 04:25	TD
111-44-4	Bis(2-chloroethyl)ether	ND		ug/L	4.34	5.26	1	EPA SW-846 8270C	02/08/2012 07:46	02/09/2012 04:25	TD
108-60-1	Bis(2-chloroisopropyl)ether	ND		ug/L	4.37	5.26	1	EPA SW-846 8270C	02/08/2012 07:46	02/09/2012 04:25	TD
117-81-7	Bis(2-ethylhexyl)phthalate	ND		ug/L	2.71	5.26	1	EPA SW-846 8270C	02/08/2012 07:46	02/09/2012 04:25	TD
218-01-9	Chrysene	ND		ug/L	4.37	5.26	1	EPA SW-846 8270C	02/08/2012 07:46	02/09/2012 04:25	TD
53-70-3	Dibenzo(a,h)anthracene	ND		ug/L	3.26	5.26	1	EPA SW-846 8270C	02/08/2012 07:46	02/09/2012 04:25	TD
132-64-9	Dibenzofuran	ND		ug/L	3.05	5.26	1	EPA SW-846 8270C	02/08/2012 07:46	02/09/2012 04:25	TD
84-66-2	Diethyl phthalate	ND		ug/L	2.32	5.26	1	EPA SW-846 8270C	02/08/2012 07:46	02/09/2012 04:25	TD
131-11-3	Dimethyl phthalate	ND		ug/L	5.10	5.26	1	EPA SW-846 8270C	02/08/2012 07:46	02/09/2012 04:25	TD
117-84-0	Di-n-butyl phthalate	ND		ug/L	4.34	5.26	1	EPA SW-846 8270C	02/08/2012 07:46	02/09/2012 04:25	TD
117-84-0	Di-n-octyl phthalate	ND		ug/L	4.37	5.26	1	EPA SW-846 8270C	02/08/2012 07:46	02/09/2012 04:25	TD
206-44-0	Fluoranthene	ND		ug/L	1.68	5.26	1	EPA SW-846 8270C	02/08/2012 07:46	02/09/2012 04:25	TD
86-73-7	Fluorene	ND		ug/L	3.39	5.26	1	EPA SW-846 8270C	02/08/2012 07:46	02/09/2012 04:25	TD
118-74-1	Hexachlorobenzene	ND		ug/L	3.11	5.26	1	EPA SW-846 8270C	02/08/2012 07:46	02/09/2012 04:25	TD
87-68-3	Hexachlorobutadiene	ND		ug/L	3.48	5.26	1	EPA SW-846 8270C	02/08/2012 07:46	02/09/2012 04:25	TD
77-47-4	Hexachlorocyclopentadiene	ND		ug/L	3.63	5.26	1	EPA SW-846 8270C	02/08/2012 07:46	02/09/2012 04:25	TD
67-72-1	Hexachloroethane	ND		ug/L	3.82	5.26	1	EPA SW-846 8270C	02/08/2012 07:46	02/09/2012 04:25	TD
193-39-5	Indeno(1,2,3-cd)pyrene	ND		ug/L	2.89	5.26	1	EPA SW-846 8270C	02/08/2012 07:46	02/09/2012 04:25	TD
78-59-1	Isophorone	ND		ug/L	3.40	5.26	1	EPA SW-846 8270C	02/08/2012 07:46	02/09/2012 04:25	TD
91-20-3	Naphthalene	ND		ug/L	4.07	5.26	1	EPA SW-846 8270C	02/08/2012 07:46	02/09/2012 04:25	TD
98-95-3	Nitrobenzene	ND		ug/L	2.07	5.26	1	EPA SW-846 8270C	02/08/2012 07:46	02/09/2012 04:25	TD
62-75-9	N-Nitrosodimethylamine	ND		ug/L	3.27	5.26	1	EPA SW-846 8270C	02/08/2012 07:46	02/09/2012 04:25	TD
621-64-7	N-nitroso-di-n-propylamine	ND		ug/L	2.71	5.26	1	EPA SW-846 8270C	02/08/2012 07:46	02/09/2012 04:25	TD
86-30-6	N-Nitrosodiphenylamine	ND		ug/L	3.81	5.26	1	EPA SW-846 8270C	02/08/2012 07:46	02/09/2012 04:25	TD
87-86-5	Pentachlorophenol	ND		ug/L	3.96	5.26	1	EPA SW-846 8270C	02/08/2012 07:46	02/09/2012 04:25	TD
85-01-8	Phenanthrene	ND		ug/L	3.80	5.26	1	EPA SW-846 8270C	02/08/2012 07:46	02/09/2012 04:25	TD
108-95-2	Phenol	ND		ug/L	3.44	5.26	1	EPA SW-846 8270C	02/08/2012 07:46	02/09/2012 04:25	TD
129-00-0	Pyrene	ND		ug/L	2.49	5.26	1	EPA SW-846 8270C	02/08/2012 07:46	02/09/2012 04:25	TD
123-06-1	Pyridine	ND		ug/L	3.35	5.26	1	EPA SW-846 8270C	02/08/2012 07:46	02/09/2012 04:25	TD

YORK

ANALYTICAL LABORATORIES, INC.

Notes and Definitions

- Q-01 The surrogate recovery for this sample may not be available due to sample dilution required from high analyte concentration and/or matrix interferences.
- QL-02 This LCS analyte is outside Laboratory Recovery limits due the analyte behavior using the referenced method. The reference method has certain limitations with respect to analytes of this nature.
- J Detected below the Reporting Limit but greater than or equal to the Method Detection Limit (MDL); therefore, the result is an estimated concentration.
- EXT-EM The sample exhibited emulsion formation during the extraction process. This may affect surrogate recoveries.
- EXT-D The sample submitted contained sediment. The aqueous portion was decanted off, the volume measured and used for the extraction. The sediment was not included in the extraction.
- B Analyte is found in the associated analysis batch blank. For volatiles, methylene chloride and acetone are common lab contaminants. Data users should consider anything <10x the blank value as artifact.
-
- ND Analyte NOT DETECTED at the stated Reporting Limit (RL) or above.
- RL REPORTING LIMIT - the minimum reportable value based upon the lowest point in the analyte calibration curve.
- MDL METHOD DETECTION LIMIT - the minimum concentration that can be measured and reported with a 99% confidence that the concentration is greater than zero. If requested or required, a value reported below the RL and above the MDL is considered estimated and is noted with a "J" flag.
- NR Not reported
- RPD Relative Percent Difference
- Wet The data has been reported on an as-received (wet weight) basis
- Low Bias Low Bias flag indicates that the recovery of the flagged analyte is below the laboratory or regulatory lower control limit. The data user should take note that this analyte may be biased low but should evaluate multiple lines of evidence including the LCS and site-specific MS/MSD data to draw bias conclusions. In cases where no site-specific MS/MSD was requested, only the LCS data can be used to evaluate such bias.
- High Bias High Bias flag indicates that the recovery of the flagged analyte is above the laboratory or regulatory upper control limit. The data user should take note that this analyte may be biased high but should evaluate multiple lines of evidence including the LCS and site-specific MS/MSD data to draw bias conclusions. In cases where no site-specific MS/MSD was requested, only the LCS data can be used to evaluate such bias.
- Non-Dir. Non-dir. flag (Non-Directional Bias) indicates that the Relative Percent Difference (RPD) (a measure of precision) among the MS and MSD data is outside the laboratory or regulatory control limit. This alerts the data user where the MS and MSD are from site-specific samples that the RPD is high due to either non-homogeneous distribution of target analyte between the MS/MSD or indicates poor reproducibility for other reasons.
- If EPA SW-846 method 8270 is included herein it is noted that the target compound N-nitrosodiphenylamine (NDPA) decomposes in the gas chromatographic inlet and cannot be separated from diphenylamine (DPA). These results could actually represent 100% DPA, 100% NDPA or some combination of the two. For this reason, York reports the combined result for n-nitrosodiphenylamine and diphenylamine for either of these compounds as a combined concentration as Diphenylamine.

Corrective Action:

YORK

ANALYTICAL LABORATORIES, INC.
 120 RESEARCH DR. STRATFORD, CT 06615
 (203) 325-1371 FAX (203) 357-0166

Field Chain-of-Custody Record

NOTE: York's Std. Terms & Conditions are listed on the back side of this document. This document serves as your written authorization to York to proceed with the analyses requested and your signature binds you to York's Std. Terms & Conditions unless superseded by written contract.

Page 1 of 1
 York Project No. 12 B 0219

YOUR Information Company: <u>COKE ENVIRONMENTAL</u> Address: <u>4611 54TH AVE</u> <u>MASAPETA NY 1370</u> Phone No: <u>(718) 786-4730</u> Contact Person: <u>RON TRAFOSCH</u> E-Mail Address: <u>YORK@COKEENV.COM</u>	Report To: Company: _____ Address: _____ Phone No: _____ Attention: _____ E-Mail Address: _____	Invoice To: Company: _____ Address: _____ Phone No: _____ Attention: _____ E-Mail Address: _____	YOUR Project ID <u>515 WEST 1574 SA</u>	Turn-Around Time <input type="checkbox"/> RUSH - Same Day <input type="checkbox"/> RUSH - Next Day <input type="checkbox"/> RUSH - Two Day <input type="checkbox"/> RUSH - Three Day <input type="checkbox"/> RUSH - Four Day Standard(5-7 Days) <input checked="" type="checkbox"/> Excel	Report Type/Deliverables <input checked="" type="checkbox"/> Summary Report <input type="checkbox"/> Summary w/ QA Summary <input type="checkbox"/> CT RCP Package <input type="checkbox"/> NY ASP A Package <input type="checkbox"/> NY ASP B Package Electronic Deliverables: <input type="checkbox"/> EDD (Specify Type) <input type="checkbox"/> Excel
Purchase Order No. _____			Samples from: CT <input checked="" type="checkbox"/> NY <input checked="" type="checkbox"/> NJ <input type="checkbox"/>		

Print Clearly and Legibly. All Information must be complete. All information must be complete. Samples will NOT be logged in and the turn-around time clock will not begin until any questions by York are resolved.

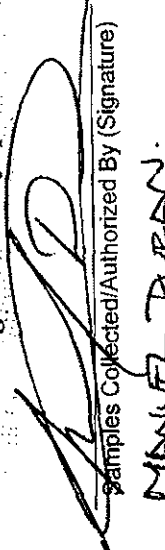
Samples Collected/Authorized By (Signature)

 MANUEL DURAN
 Name (printed)

Matrix Codes	Volatiles	Semi-Vols.	Pest/PCB/Herb	Metals	Misc. Org.	Full Lists	Common Miscellaneous Parameters	Special Instructions	
S - soil Other - specify (oil, etc.) GW - groundwater DW - drinking water Air-A - ambient air Air-SV - soil vapor	8260 full TIC's Site Spec. STARS list Nassau Co. Suffolk Co. Ketones Oxygenates TCLP list TAGM list CT RCP list 524.2 Arom. only 502.2 Halog. only NJDEP list App. IX SPLP or TCLP 8021B list	8270 or 625 STARS list IBN Only Acids Only PAH list TAGM list CT RCP list SPLP or TCLP Total Dissolved SPLP or TCLP Imp. Metals LIST Below 608 PCB	RCRA8 PP13 list TAL CTI.5 list TAGM list NJDEP list Total Dissolved SPLP or TCLP Imp. Metals LIST Below 608 PCB	RCRA8 PP13 list TAL CTI.5 list TAGM list NJDEP list Total Dissolved SPLP or TCLP Imp. Metals LIST Below 608 PCB	TPH GRO TPH DRO CT ETPH NY 310-13 TPH 1664 Air TO14A Air TO15 Air STARS Air VPH Air TICs Helium	Pri. Poll. TCL Organic TAL MetCN Full TCLP Full App. IX Part 360 Pestic Part 360 Pestic Part 360 Pestic Part 360 Pestic NYDEP Sewer TAGM	Nitrate Nitrite TKN Tot. Nitrogen Ammonia-N Chloride Phosphate Tot. Phos. COD Oil & Grease F.O.G. pH MRAS	Color Phenols Cyanide-T Cyanide-A BOD5 CBOD5 BOD28 TSS Total Solids TDS TPH-1664	Field Filtered <input type="checkbox"/> Lab to Filter <input type="checkbox"/>

Sample Identification	Date Sampled	Sample Matrix	Choose Analyses Needed from the Menu Above and Enter Below	Container Description(s)
515W18-SB/MW1-GW	2-6-12	GW	FULL LIST VOC / SVOC	(2) VOA / HCL
515W18-SB/MW2-GW	2-6-12	GW		(1) AMBER
515W18-SB/MW3-GW	2-6-12	GW		
515W18-SB/MW4-GW	2-6-12	GW		
515W18-SB/MW5-GW	2-6-12	GW		
515W18-SB/MW6-GW	2-6-12	GW		
515W18-SB/MW19-GW	2-6-12	GW		
515W18-SB/MW22-GW	2-6-12	GW		
515W18-SB/MW7A-GW	2-6-12	GW		

Comments

4°C Frozen HCl MeOH HNO₃ H₂SO₄ NaOH Other _____

Preservation Check those Applicable
 ZnAc Ascorbic Acid

Samples Relinquished By Anna Dmureny Date/Time 2/7/12 8:30 AM
 Samples Received By Blah Date/Time 2-7-12 8:30 AM

Samples Relinquished By _____ Date/Time _____
 Samples Received in LAB by _____ Date/Time _____

Temperature on Receipt 3.9 °C

YORK

ANALYTICAL LABORATORIES, INC.

Technical Report

prepared for:

Core Environmental
2312 Wehrle Drive
Williamsville NY, 14221
Attention: Ron Tramosch

Report Date: 02/07/2012
Client Project ID: 515 West 18th St.
York Project (SDG) No.: 12A0987

CT License No. PH-0723

New Jersey License No. CT-005



New York License No. 10854

PA License No. 68-04440

Report Date: 02/07/2012
Client Project ID: 515 West 18th St.
York Project (SDG) No.: 12A0987

Core Environmental
2312 Wehrle Drive
Williamsville NY, 14221
Attention: Ron Tramposch

Purpose and Results

This report contains the analytical data for the sample(s) identified on the attached chain-of-custody received in our laboratory on January 30, 2012 and listed below. The project was identified as your project: **515 West 18th St.**

The analyses were conducted utilizing appropriate EPA, Standard Methods, and ASTM methods as detailed in the data summary tables.

All samples were received in proper condition meeting the customary acceptance requirements for environmental samples except those indicated under the Notes section of this report.

All analyses met the method and laboratory standard operating procedure requirements except as indicated by any data flags, the meaning of which are explained in the attachment to this report, and case narrative if applicable.

The results of the analyses, which are all reported on dry weight basis (soils) unless otherwise noted, are detailed in the following pages.

Please contact Client Services at 203.325.1371 with any questions regarding this report.

<u>York Sample ID</u>	<u>Client Sample ID</u>	<u>Matrix</u>	<u>Date Collected</u>	<u>Date Received</u>
12A0987-01	515W18-SB-1-8'-9'-Grab	Soil	01/23/2012	01/30/2012
12A0987-02	515W18-SB-2-8'-9'-Grab	Soil	01/23/2012	01/30/2012
12A0987-03	515W18-SB-3-6'-6.5'-Grab	Soil	01/25/2012	01/30/2012
12A0987-04	515W18-SB-4-7'-8'-Grab	Soil	01/27/2012	01/30/2012
12A0987-05	515W18-SB-5-9'-9.5'-Grab	Soil	01/26/2012	01/30/2012
12A0987-06	515W18-SB-6-10'-10.5'-Grab	Soil	01/26/2012	01/30/2012
12A0987-07	515W18-SB-7-7'-8'-Grab	Soil	01/27/2012	01/30/2012
12A0987-08	515W18-SB-8-8'-9'-Grab	Soil	01/27/2012	01/30/2012

General Notes for York Project (SDG) No.: 12A0987

1. The RLs and MDLs (Reporting Limit and Method Detection Limit respectively) reported are adjusted for any dilution necessary due to the levels of target and/or non-target analytes and matrix interference. The RL(REPORTING LIMIT) is based upon the lowest standard utilized for the calibration where applicable.
Samples are retained for a period of thirty days after submittal of report, unless other arrangements are made.
2. York's liability for the above data is limited to the dollar value paid to York for the referenced project.
4. This report shall not be reproduced without the written approval of York Analytical Laboratories, Inc.
5. All samples were received in proper condition for analysis with proper documentation, unless otherwise noted.
6. All analyses conducted met method or Laboratory SOP requirements. See the Qualifiers and/or Narrative sections for further information.
7. It is noted that no analyses reported herein were subcontracted to another laboratory, unless noted in the report.
8. This report reflects results that relate only to the samples submitted on the attached chain-of-custody form(s) received by York.

Approved By:



Date: 02/07/2012

Robert Q. Bradley
Executive Vice President / Laboratory Director

YORK

YORK

ANALYTICAL LABORATORIES, INC.

Sample Information

Client Sample ID: 515W18-SB-1-8'-9'-Grab

York Sample ID: 12A0987-01

York Project (SDG) No.
12A0987

Client Project ID
515 West 18th St.

Matrix
Soil

Collection Date/Time
January 23, 2012 3:00 pm

Date Received
01/30/2012

Volatile Organics, 8260 List

Log-in Notes:

Sample Notes:

Sample Prepared by Method: EPA 5035B

CAS No.	Parameter	Result	Flag	Units	MDL	RL	Dilution	Reference Method	Date/Time Prepared	Date/Time Analyzed	Analyst
630-20-6	1,1,1,2-Tetrachloroethane	ND		ug/kg dry	65	560	100	EPA SW846-8260B	02/03/2012 16:33	02/03/2012 21:53	SS
71-55-6	1,1,1-Trichloroethane	ND		ug/kg dry	110	560	100	EPA SW846-8260B	02/03/2012 16:33	02/03/2012 21:53	SS
79-34-5	1,1,2,2-Tetrachloroethane	ND		ug/kg dry	69	560	100	EPA SW846-8260B	02/03/2012 16:33	02/03/2012 21:53	SS
76-13-1	1,1,2-Trichloro-1,2,2-trifluoroethane (Freon 113)	ND		ug/kg dry	72	560	100	EPA SW846-8260B	02/03/2012 16:33	02/03/2012 21:53	SS
79-00-5	1,1,2-Trichloroethane	ND		ug/kg dry	74	560	100	EPA SW846-8260B	02/03/2012 16:33	02/03/2012 21:53	SS
75-34-3	1,1-Dichloroethane	ND		ug/kg dry	83	560	100	EPA SW846-8260B	02/03/2012 16:33	02/03/2012 21:53	SS
75-35-4	1,1-Dichloroethylene	ND		ug/kg dry	160	560	100	EPA SW846-8260B	02/03/2012 16:33	02/03/2012 21:53	SS
563-58-6	1,1-Dichloropropylene	ND		ug/kg dry	52	560	100	EPA SW846-8260B	02/03/2012 16:33	02/03/2012 21:53	SS
87-61-6	1,2,3-Trichlorobenzene	ND		ug/kg dry	45	1100	100	EPA SW846-8260B	02/03/2012 16:33	02/03/2012 21:53	SS
96-18-4	1,2,3-Trichloropropane	ND		ug/kg dry	140	560	100	EPA SW846-8260B	02/03/2012 16:33	02/03/2012 21:53	SS
120-82-1	1,2,4-Trichlorobenzene	ND		ug/kg dry	58	1100	100	EPA SW846-8260B	02/03/2012 16:33	02/03/2012 21:53	SS
95-63-6	1,2,4-Trimethylbenzene	ND		ug/kg dry	64	560	100	EPA SW846-8260B	02/03/2012 16:33	02/03/2012 21:53	SS
112-8	1,2-Dibromo-3-chloropropane	ND		ug/kg dry	160	1100	100	EPA SW846-8260B	02/03/2012 16:33	02/03/2012 21:53	SS
106-93-4	1,2-Dibromoethane	ND		ug/kg dry	82	560	100	EPA SW846-8260B	02/03/2012 16:33	02/03/2012 21:53	SS
95-50-1	1,2-Dichlorobenzene	ND		ug/kg dry	71	560	100	EPA SW846-8260B	02/03/2012 16:33	02/03/2012 21:53	SS
107-06-2	1,2-Dichloroethane	ND		ug/kg dry	78	560	100	EPA SW846-8260B	02/03/2012 16:33	02/03/2012 21:53	SS
78-87-5	1,2-Dichloropropane	ND		ug/kg dry	27	560	100	EPA SW846-8260B	02/03/2012 16:33	02/03/2012 21:53	SS
108-67-8	1,3,5-Trimethylbenzene	ND		ug/kg dry	45	560	100	EPA SW846-8260B	02/03/2012 16:33	02/03/2012 21:53	SS
541-73-1	1,3-Dichlorobenzene	ND		ug/kg dry	57	560	100	EPA SW846-8260B	02/03/2012 16:33	02/03/2012 21:53	SS
142-28-9	1,3-Dichloropropane	ND		ug/kg dry	83	560	100	EPA SW846-8260B	02/03/2012 16:33	02/03/2012 21:53	SS
106-46-7	1,4-Dichlorobenzene	ND		ug/kg dry	82	560	100	EPA SW846-8260B	02/03/2012 16:33	02/03/2012 21:53	SS
594-20-7	2,2-Dichloropropane	ND		ug/kg dry	120	560	100	EPA SW846-8260B	02/03/2012 16:33	02/03/2012 21:53	SS
78-93-3	2-Butanone	ND		ug/kg dry	310	1100	100	EPA SW846-8260B	02/03/2012 16:33	02/03/2012 21:53	SS
95-49-8	2-Chlorotoluene	ND		ug/kg dry	59	560	100	EPA SW846-8260B	02/03/2012 16:33	02/03/2012 21:53	SS
106-43-4	4-Chlorotoluene	ND		ug/kg dry	59	560	100	EPA SW846-8260B	02/03/2012 16:33	02/03/2012 21:53	SS
67-64-1	Acetone	1100		ug/kg dry	380	1100	100	EPA SW846-8260B	02/03/2012 16:33	02/03/2012 21:53	SS
71-43-2	Benzene	ND		ug/kg dry	58	560	100	EPA SW846-8260B	02/03/2012 16:33	02/03/2012 21:53	SS
108-86-1	Bromobenzene	ND		ug/kg dry	74	560	100	EPA SW846-8260B	02/03/2012 16:33	02/03/2012 21:53	SS
74-97-5	Bromochloromethane	ND		ug/kg dry	150	560	100	EPA SW846-8260B	02/03/2012 16:33	02/03/2012 21:53	SS
75-27-4	Bromodichloromethane	ND		ug/kg dry	75	560	100	EPA SW846-8260B	02/03/2012 16:33	02/03/2012 21:53	SS
75-25-2	Bromoform	ND		ug/kg dry	70	560	100	EPA SW846-8260B	02/03/2012 16:33	02/03/2012 21:53	SS
3-9	Bromomethane	690		ug/kg dry	150	560	100	EPA SW846-8260B	02/03/2012 16:33	02/03/2012 21:53	SS
56-23-5	Carbon tetrachloride	ND		ug/kg dry	130	560	100	EPA SW846-8260B	02/03/2012 16:33	02/03/2012 21:53	SS
108-90-7	Chlorobenzene	ND		ug/kg dry	42	560	100	EPA SW846-8260B	02/03/2012 16:33	02/03/2012 21:53	SS

YORK

ANALYTICAL LABORATORIES, INC.

Sample Information

Client Sample ID: 515W18-SB-1-8'-9'-Grab

York Sample ID: 12A0987-01

York Project (SDG) No.
12A0987

Client Project ID
515 West 18th St.

Matrix
Soil

Collection Date/Time
January 23, 2012 3:00 pm

Date Received
01/30/2012

Volatiles Organics, 8260 List

Log-in Notes:

Sample Notes:

Sample Prepared by Method: EPA 5035B

CAS No.	Parameter	Result	Flag	Units	MDL	RL	Dilution	Reference Method	Date/Time Prepared	Date/Time Analyzed	Analyst
75-00-3	Chloroethane	ND		ug/kg dry	92	560	100	EPA SW846-8260B	02/03/2012 16:33	02/03/2012 21:53	SS
67-66-3	Chloroform	ND		ug/kg dry	43	560	100	EPA SW846-8260B	02/03/2012 16:33	02/03/2012 21:53	SS
74-87-3	Chloromethane	ND		ug/kg dry	110	560	100	EPA SW846-8260B	02/03/2012 16:33	02/03/2012 21:53	SS
156-59-2	cis-1,2-Dichloroethylene	ND		ug/kg dry	120	560	100	EPA SW846-8260B	02/03/2012 16:33	02/03/2012 21:53	SS
10061-01-5	cis-1,3-Dichloropropylene	ND		ug/kg dry	42	560	100	EPA SW846-8260B	02/03/2012 16:33	02/03/2012 21:53	SS
124-48-1	Dibromochloromethane	ND		ug/kg dry	81	560	100	EPA SW846-8260B	02/03/2012 16:33	02/03/2012 21:53	SS
74-95-3	Dibromomethane	ND		ug/kg dry	160	560	100	EPA SW846-8260B	02/03/2012 16:33	02/03/2012 21:53	SS
75-71-8	Dichlorodifluoromethane	ND		ug/kg dry	100	560	100	EPA SW846-8260B	02/03/2012 16:33	02/03/2012 21:53	SS
100-41-4	Ethyl Benzene	ND		ug/kg dry	42	560	100	EPA SW846-8260B	02/03/2012 16:33	02/03/2012 21:53	SS
87-68-3	Hexachlorobutadiene	ND		ug/kg dry	52	560	100	EPA SW846-8260B	02/03/2012 16:33	02/03/2012 21:53	SS
98-82-8	Isopropylbenzene	ND		ug/kg dry	47	560	100	EPA SW846-8260B	02/03/2012 16:33	02/03/2012 21:53	SS
1634-04-4	Methyl tert-butyl ether (MTBE)	ND		ug/kg dry	46	560	100	EPA SW846-8260B	02/03/2012 16:33	02/03/2012 21:53	SS
9-2	Methylene chloride	690	J, B	ug/kg dry	130	1100	100	EPA SW846-8260B	02/03/2012 16:33	02/03/2012 21:53	SS
123-20-3	Naphthalene	ND		ug/kg dry	60	1100	100	EPA SW846-8260B	02/03/2012 16:33	02/03/2012 21:53	SS
104-51-8	n-Butylbenzene	570		ug/kg dry	39	560	100	EPA SW846-8260B	02/03/2012 16:33	02/03/2012 21:53	SS
103-65-1	n-Propylbenzene	ND		ug/kg dry	70	560	100	EPA SW846-8260B	02/03/2012 16:33	02/03/2012 21:53	SS
95-47-6	o-Xylene	ND		ug/kg dry	60	560	100	EPA SW846-8260B	02/03/2012 16:33	02/03/2012 21:53	SS
1330-20-7P/M	p- & m- Xylenes	ND		ug/kg dry	66	1100	100	EPA SW846-8260B	02/03/2012 16:33	02/03/2012 21:53	SS
99-87-6	p-Isopropyltoluene	ND		ug/kg dry	30	560	100	EPA SW846-8260B	02/03/2012 16:33	02/03/2012 21:53	SS
135-98-8	sec-Butylbenzene	960		ug/kg dry	63	560	100	EPA SW846-8260B	02/03/2012 16:33	02/03/2012 21:53	SS
100-42-5	Styrene	ND		ug/kg dry	52	560	100	EPA SW846-8260B	02/03/2012 16:33	02/03/2012 21:53	SS
98-06-6	tert-Butylbenzene	ND		ug/kg dry	55	560	100	EPA SW846-8260B	02/03/2012 16:33	02/03/2012 21:53	SS
127-18-4	Tetrachloroethylene	ND		ug/kg dry	63	560	100	EPA SW846-8260B	02/03/2012 16:33	02/03/2012 21:53	SS
108-88-3	Toluene	ND		ug/kg dry	28	560	100	EPA SW846-8260B	02/03/2012 16:33	02/03/2012 21:53	SS
156-60-5	trans-1,2-Dichloroethylene	ND		ug/kg dry	78	560	100	EPA SW846-8260B	02/03/2012 16:33	02/03/2012 21:53	SS
10061-02-6	trans-1,3-Dichloropropylene	ND		ug/kg dry	82	560	100	EPA SW846-8260B	02/03/2012 16:33	02/03/2012 21:53	SS
79-01-6	Trichloroethylene	ND		ug/kg dry	69	560	100	EPA SW846-8260B	02/03/2012 16:33	02/03/2012 21:53	SS
75-69-4	Trichlorofluoromethane	ND		ug/kg dry	110	560	100	EPA SW846-8260B	02/03/2012 16:33	02/03/2012 21:53	SS
75-01-4	Vinyl Chloride	ND		ug/kg dry	120	560	100	EPA SW846-8260B	02/03/2012 16:33	02/03/2012 21:53	SS
1330-20-7	Xylenes, Total	ND		ug/kg dry	130	1700	100	EPA SW846-8260B	02/03/2012 16:33	02/03/2012 21:53	SS

YORK

ANALYTICAL LABORATORIES, INC.

Sample Information

Client Sample ID: 515W18-SB-1-8'-9'-Grab

York Sample ID: 12A0987-01

York Project (SDG) No.
12A0987

Client Project ID
515 West 18th St.

Matrix
Soil

Collection Date/Time
January 23, 2012 3:00 pm

Date Received
01/30/2012

Semi-Volatiles, 8270 Target List

Log-in Notes:

Sample Notes:

Sample Prepared by Method: EPA 350B

CAS No.	Parameter	Result	Flag	Units	MDL	RL	Dilution	Reference Method	Date/Time Prepared	Date/Time Analyzed	Analyst
120-82-1	1,2,4-Trichlorobenzene	ND		ug/kg dry	102	186	1	EPA SW-846 8270C	02/03/2012 08:34	02/04/2012 00:00	TD
95-50-1	1,2-Dichlorobenzene	ND		ug/kg dry	81.5	186	1	EPA SW-846 8270C	02/03/2012 08:34	02/04/2012 00:00	TD
541-73-1	1,3-Dichlorobenzene	ND		ug/kg dry	88.7	186	1	EPA SW-846 8270C	02/03/2012 08:34	02/04/2012 00:00	TD
106-46-7	1,4-Dichlorobenzene	ND		ug/kg dry	63.9	186	1	EPA SW-846 8270C	02/03/2012 08:34	02/04/2012 00:00	TD
95-95-4	2,4,5-Trichlorophenol	ND		ug/kg dry	50.6	186	1	EPA SW-846 8270C	02/03/2012 08:34	02/04/2012 00:00	TD
88-06-2	2,4,6-Trichlorophenol	ND		ug/kg dry	91.1	186	1	EPA SW-846 8270C	02/03/2012 08:34	02/04/2012 00:00	TD
120-83-2	2,4-Dichlorophenol	ND		ug/kg dry	76.1	186	1	EPA SW-846 8270C	02/03/2012 08:34	02/04/2012 00:00	TD
105-67-9	2,4-Dimethylphenol	ND		ug/kg dry	59.7	186	1	EPA SW-846 8270C	02/03/2012 08:34	02/04/2012 00:00	TD
51-28-5	2,4-Dinitrophenol	ND		ug/kg dry	156	372	1	EPA SW-846 8270C	02/03/2012 08:34	02/04/2012 00:00	TD
121-14-2	2,4-Dinitrotoluene	ND		ug/kg dry	81.5	186	1	EPA SW-846 8270C	02/03/2012 08:34	02/04/2012 00:00	TD
606-20-2	2,6-Dinitrotoluene	ND		ug/kg dry	88.7	186	1	EPA SW-846 8270C	02/03/2012 08:34	02/04/2012 00:00	TD
91-58-7	2-Chloronaphthalene	ND		ug/kg dry	56.8	186	1	EPA SW-846 8270C	02/03/2012 08:34	02/04/2012 00:00	TD
7-8	2-Chlorophenol	ND		ug/kg dry	108	186	1	EPA SW-846 8270C	02/03/2012 08:34	02/04/2012 00:00	TD
91-57-6	2-Methylnaphthalene	ND		ug/kg dry	64.8	186	1	EPA SW-846 8270C	02/03/2012 08:34	02/04/2012 00:00	TD
95-48-7	2-Methylphenol	ND		ug/kg dry	68.5	186	1	EPA SW-846 8270C	02/03/2012 08:34	02/04/2012 00:00	TD
88-75-5	2-Nitrophenol	ND		ug/kg dry	63.9	186	1	EPA SW-846 8270C	02/03/2012 08:34	02/04/2012 00:00	TD
100-01-6	3- & 4-Methylphenols	ND		ug/kg dry	83.8	186	1	EPA SW-846 8270C	02/03/2012 08:34	02/04/2012 00:00	TD
91-94-1	3,3'-Dichlorobenzidine	ND		ug/kg dry	46.9	186	1	EPA SW-846 8270C	02/03/2012 08:34	02/04/2012 00:00	TD
99-09-2	3-Nitroaniline	ND		ug/kg dry	67.5	186	1	EPA SW-846 8270C	02/03/2012 08:34	02/04/2012 00:00	TD
534-52-1	4,6-Dinitro-2-methylphenol	ND		ug/kg dry	141	372	1	EPA SW-846 8270C	02/03/2012 08:34	02/04/2012 00:00	TD
101-55-3	4-Bromophenyl phenyl ether	ND		ug/kg dry	77.6	186	1	EPA SW-846 8270C	02/03/2012 08:34	02/04/2012 00:00	TD
59-50-7	4-Chloro-3-methylphenol	ND		ug/kg dry	20.1	186	1	EPA SW-846 8270C	02/03/2012 08:34	02/04/2012 00:00	TD
106-47-8	4-Chloroaniline	ND		ug/kg dry	73.5	186	1	EPA SW-846 8270C	02/03/2012 08:34	02/04/2012 00:00	TD
7005-72-3	4-Chlorophenyl phenyl ether	ND		ug/kg dry	53.7	186	1	EPA SW-846 8270C	02/03/2012 08:34	02/04/2012 00:00	TD
100-02-7	4-Nitroaniline	ND		ug/kg dry	61.8	186	1	EPA SW-846 8270C	02/03/2012 08:34	02/04/2012 00:00	TD
56-57-5	4-Nitrophenol	ND		ug/kg dry	67.3	186	1	EPA SW-846 8270C	02/03/2012 08:34	02/04/2012 00:00	TD
83-32-9	Acenaphthene	ND		ug/kg dry	108	186	1	EPA SW-846 8270C	02/03/2012 08:34	02/04/2012 00:00	TD
208-96-8	Acenaphthylene	ND		ug/kg dry	52.2	186	1	EPA SW-846 8270C	02/03/2012 08:34	02/04/2012 00:00	TD
62-53-3	Aniline	ND		ug/kg dry	67.0	186	1	EPA SW-846 8270C	02/03/2012 08:34	02/04/2012 00:00	TD
120-12-7	Anthracene	ND		ug/kg dry	46.2	186	1	EPA SW-846 8270C	02/03/2012 08:34	02/04/2012 00:00	TD
56-55-3	Benzo(a)anthracene	ND		ug/kg dry	72.0	186	1	EPA SW-846 8270C	02/03/2012 08:34	02/04/2012 00:00	TD
7-8	Benzo(a)pyrene	ND		ug/kg dry	48.5	186	1	EPA SW-846 8270C	02/03/2012 08:34	02/04/2012 00:00	TD
205-99-2	Benzo(b)fluoranthene	ND		ug/kg dry	70.8	186	1	EPA SW-846 8270C	02/03/2012 08:34	02/04/2012 00:00	TD
191-24-2	Benzo(g,h,i)perylene	ND		ug/kg dry	56.0	186	1	EPA SW-846 8270C	02/03/2012 08:34	02/04/2012 00:00	TD
207-08-9	Benzo(k)fluoranthene	ND		ug/kg dry	72.1	186	1	EPA SW-846 8270C	02/03/2012 08:34	02/04/2012 00:00	TD

YORK

ANALYTICAL LABORATORIES, INC.

Sample Information

Client Sample ID: 515W18-SB-1-8'-9'-Grab

York Sample ID: 12A0987-01

York Project (SDG) No.
12A0987

Client Project ID
515 West 18th St.

Matrix
Soil

Collection Date/Time
January 23, 2012 3:00 pm

Date Received
01/30/2012

Semi-Volatiles, 8270 Target List

Log-in Notes:

Sample Notes:

Sample Prepared by Method: EPA 3550B

CAS No.	Parameter	Result	Flag	Units	MDL	RL	Dilution	Reference Method	Date/Time Prepared	Date/Time Analyzed	Analyst
100-51-6	Benzyl alcohol	ND		ug/kg dry	60.3	186	J	EPA SW-846 8270C	02/03/2012 08:34	02/04/2012 00:00	TD
85-68-7	Benzyl butyl phthalate	ND		ug/kg dry	77.7	186	1	EPA SW-846 8270C	02/03/2012 08:34	02/04/2012 00:00	TD
111-91-1	Bis(2-chloroethoxy)methane	ND		ug/kg dry	68.6	186	1	EPA SW-846 8270C	02/03/2012 08:34	02/04/2012 00:00	TD
111-44-4	Bis(2-chloroethyl)ether	ND		ug/kg dry	63.2	186	1	EPA SW-846 8270C	02/03/2012 08:34	02/04/2012 00:00	TD
108-60-1	Bis(2-chloroisopropyl)ether	ND		ug/kg dry	69.2	186	1	EPA SW-846 8270C	02/03/2012 08:34	02/04/2012 00:00	TD
117-81-7	Bis(2-ethylhexyl)phthalate	ND		ug/kg dry	62.3	186	1	EPA SW-846 8270C	02/03/2012 08:34	02/04/2012 00:00	TD
218-01-9	Chrysene	ND		ug/kg dry	75.0	186	1	EPA SW-846 8270C	02/03/2012 08:34	02/04/2012 00:00	TD
53-70-3	Dibenzo(a,h)anthracene	ND		ug/kg dry	47.1	186	1	EPA SW-846 8270C	02/03/2012 08:34	02/04/2012 00:00	TD
132-64-9	Dibenzofuran	ND		ug/kg dry	60.1	186	1	EPA SW-846 8270C	02/03/2012 08:34	02/04/2012 00:00	TD
84-66-2	Diethyl phthalate	ND		ug/kg dry	97.7	186	1	EPA SW-846 8270C	02/03/2012 08:34	02/04/2012 00:00	TD
131-11-3	Dimethyl phthalate	ND		ug/kg dry	53.7	186	1	EPA SW-846 8270C	02/03/2012 08:34	02/04/2012 00:00	TD
84-74-2	Di-n-butyl phthalate	ND		ug/kg dry	55.6	186	1	EPA SW-846 8270C	02/03/2012 08:34	02/04/2012 00:00	TD
84-0	Di-n-octyl phthalate	ND		ug/kg dry	83.8	186	1	EPA SW-846 8270C	02/03/2012 08:34	02/04/2012 00:00	TD
206-44-0	Fluoranthene	146	J	ug/kg dry	108	186	1	EPA SW-846 8270C	02/03/2012 08:34	02/04/2012 00:00	TD
86-73-7	Fluorene	ND		ug/kg dry	52.2	186	1	EPA SW-846 8270C	02/03/2012 08:34	02/04/2012 00:00	TD
118-74-1	Hexachlorobenzene	ND		ug/kg dry	30.3	186	1	EPA SW-846 8270C	02/03/2012 08:34	02/04/2012 00:00	TD
87-68-3	Hexachlorobutadiene	ND		ug/kg dry	74.5	186	1	EPA SW-846 8270C	02/03/2012 08:34	02/04/2012 00:00	TD
77-47-4	Hexachlorocyclopentadiene	ND		ug/kg dry	138	186	1	EPA SW-846 8270C	02/03/2012 08:34	02/04/2012 00:00	TD
67-72-1	Hexachloroethane	ND		ug/kg dry	67.0	186	1	EPA SW-846 8270C	02/03/2012 08:34	02/04/2012 00:00	TD
193-39-5	Indeno(1,2,3-cd)pyrene	ND		ug/kg dry	68.6	186	1	EPA SW-846 8270C	02/03/2012 08:34	02/04/2012 00:00	TD
78-59-1	Isophorone	ND		ug/kg dry	69.2	186	1	EPA SW-846 8270C	02/03/2012 08:34	02/04/2012 00:00	TD
91-20-3	Naphthalene	215		ug/kg dry	55.6	186	1	EPA SW-846 8270C	02/03/2012 08:34	02/04/2012 00:00	TD
98-95-3	Nitrobenzene	ND		ug/kg dry	83.8	186	1	EPA SW-846 8270C	02/03/2012 08:34	02/04/2012 00:00	TD
62-75-9	N-Nitrosodimethylamine	ND		ug/kg dry	67.3	186	1	EPA SW-846 8270C	02/03/2012 08:34	02/04/2012 00:00	TD
621-64-7	N-nitroso-di-n-propylamine	ND		ug/kg dry	48.6	186	1	EPA SW-846 8270C	02/03/2012 08:34	02/04/2012 00:00	TD
86-30-6	N-Nitrosodiphenylamine	ND		ug/kg dry	108	186	1	EPA SW-846 8270C	02/03/2012 08:34	02/04/2012 00:00	TD
87-86-5	Pentachlorophenol	ND		ug/kg dry	52.2	186	1	EPA SW-846 8270C	02/03/2012 08:34	02/04/2012 00:00	TD
85-01-8	Phenanthrene	ND		ug/kg dry	68.7	186	1	EPA SW-846 8270C	02/03/2012 08:34	02/04/2012 00:00	TD
108-95-2	Phenol	ND		ug/kg dry	74.5	186	1	EPA SW-846 8270C	02/03/2012 08:34	02/04/2012 00:00	TD
129-00-0	Pyrene	139	J	ug/kg dry	66.8	186	1	EPA SW-846 8270C	02/03/2012 08:34	02/04/2012 00:00	TD
110-86-1	Pyridine	ND		ug/kg dry	72.7	186	1	EPA SW-846 8270C	02/03/2012 08:34	02/04/2012 00:00	TD

YORK

ANALYTICAL LABORATORIES, INC.

Sample Information

Client Sample ID: 515W18-SB-1-8'-9'-Grab

York Sample ID: 12A0987-01

York Project (SDG) No.
12A0987

Client Project ID
515 West 18th St.

Matrix
Soil

Collection Date/Time
January 23, 2012 3:00 pm

Date Received
01/30/2012

Total Solids

Log-in Notes:

Sample Notes:

Sample Prepared by Method: % Solids Prep

CAS No.	Parameter	Result	Flag	Units	MDL	RL	Dilution	Reference Method	Date/Time Prepared	Date/Time Analyzed	Analyst
solids	% Solids	89.5		%	0.100	0.100	1	SM 2540G	02/03/2012 14:33	02/03/2012 14:33	JCC

Sample Information

Client Sample ID: 515W18-SB-2-8'-9'-Grab

York Sample ID: 12A0987-02

York Project (SDG) No.
12A0987

Client Project ID
515 West 18th St.

Matrix
Soil

Collection Date/Time
January 23, 2012 3:00 pm

Date Received
01/30/2012

Volatile Organics, 8260 List

Log-in Notes:

Sample Notes:

Sample Prepared by Method: EPA 5035B

CAS No.	Parameter	Result	Flag	Units	MDL	RL	Dilution	Reference Method	Date/Time Prepared	Date/Time Analyzed	Analyst
630-20-6	1,1,1,2-Tetrachloroethane	ND		ug/kg dry	68	580	100	EPA SW846-8260B	02/03/2012 16:33	02/03/2012 22:29	SS
71-55-6	1,1,1-Trichloroethane	ND		ug/kg dry	120	580	100	EPA SW846-8260B	02/03/2012 16:33	02/03/2012 22:29	SS
79-34-5	1,1,2,2-Tetrachloroethane	ND		ug/kg dry	72	580	100	EPA SW846-8260B	02/03/2012 16:33	02/03/2012 22:29	SS
33-1	1,1,2-Trichloro-1,2,2-trifluoroethane (Freon 113)	ND		ug/kg dry	76	580	100	EPA SW846-8260B	02/03/2012 16:33	02/03/2012 22:29	SS
79-00-5	1,1,2-Trichloroethane	ND		ug/kg dry	77	580	100	EPA SW846-8260B	02/03/2012 16:33	02/03/2012 22:29	SS
75-34-3	1,1-Dichloroethane	ND		ug/kg dry	87	580	100	EPA SW846-8260B	02/03/2012 16:33	02/03/2012 22:29	SS
75-35-4	1,1-Dichloroethylene	ND		ug/kg dry	170	580	100	EPA SW846-8260B	02/03/2012 16:33	02/03/2012 22:29	SS
563-58-6	1,1-Dichloropropylene	ND		ug/kg dry	54	580	100	EPA SW846-8260B	02/03/2012 16:33	02/03/2012 22:29	SS
87-61-6	1,2,3-Trichlorobenzene	ND		ug/kg dry	47	1200	100	EPA SW846-8260B	02/03/2012 16:33	02/03/2012 22:29	SS
96-18-4	1,2,3-Trichloropropane	ND		ug/kg dry	140	580	100	EPA SW846-8260B	02/03/2012 16:33	02/03/2012 22:29	SS
120-82-1	1,2,4-Trichlorobenzene	ND		ug/kg dry	60	1200	100	EPA SW846-8260B	02/03/2012 16:33	02/03/2012 22:29	SS
95-63-6	1,2,4-Trimethylbenzene	ND		ug/kg dry	67	580	100	EPA SW846-8260B	02/03/2012 16:33	02/03/2012 22:29	SS
96-12-8	1,2-Dibromo-3-chloropropane	ND		ug/kg dry	170	1200	100	EPA SW846-8260B	02/03/2012 16:33	02/03/2012 22:29	SS
106-93-4	1,2-Dibromoethane	ND		ug/kg dry	86	580	100	EPA SW846-8260B	02/03/2012 16:33	02/03/2012 22:29	SS
95-50-1	1,2-Dichlorobenzene	ND		ug/kg dry	74	580	100	EPA SW846-8260B	02/03/2012 16:33	02/03/2012 22:29	SS
107-06-2	1,2-Dichloroethane	ND		ug/kg dry	82	580	100	EPA SW846-8260B	02/03/2012 16:33	02/03/2012 22:29	SS
78-87-5	1,2-Dichloropropane	ND		ug/kg dry	28	580	100	EPA SW846-8260B	02/03/2012 16:33	02/03/2012 22:29	SS
108-67-8	1,3,5-Trimethylbenzene	ND		ug/kg dry	47	580	100	EPA SW846-8260B	02/03/2012 16:33	02/03/2012 22:29	SS
541-73-1	1,3-Dichlorobenzene	ND		ug/kg dry	59	580	100	EPA SW846-8260B	02/03/2012 16:33	02/03/2012 22:29	SS
142-28-9	1,3-Dichloropropane	ND		ug/kg dry	87	580	100	EPA SW846-8260B	02/03/2012 16:33	02/03/2012 22:29	SS
106-46-7	1,4-Dichlorobenzene	ND		ug/kg dry	86	580	100	EPA SW846-8260B	02/03/2012 16:33	02/03/2012 22:29	SS
70-7	2,2-Dichloropropane	ND		ug/kg dry	120	580	100	EPA SW846-8260B	02/03/2012 16:33	02/03/2012 22:29	SS
78-93-3	2-Butanone	ND		ug/kg dry	320	1200	100	EPA SW846-8260B	02/03/2012 16:33	02/03/2012 22:29	SS
95-49-8	2-Chlorotoluene	ND		ug/kg dry	62	580	100	EPA SW846-8260B	02/03/2012 16:33	02/03/2012 22:29	SS

YORK

ANALYTICAL LABORATORIES, INC.

Sample Information

Client Sample ID: 515W18-SB-2-8'-9'-Grab

York Sample ID: 12A0987-02

York Project (SDG) No. 12A0987	Client Project ID 515 West 18th St.	Matrix Soil	Collection Date/Time January 23, 2012 3:00 pm	Date Received 01/30/2012
-----------------------------------	--	----------------	--	-----------------------------

Volatiles Organics, 8260 List

Log-in Notes:

Sample Notes:

Sample Prepared by Method: EPA 5035B

CAS No.	Parameter	Result	Flag	Units	MDL	RL	Dilution	Reference Method	Date/Time Prepared	Date/Time Analyzed	Analyst
106-43-4	4-Chlorotoluene	ND		ug/kg dry	62	580	100	EPA SW846-8260B	02/03/2012 16:33	02/03/2012 22:29	SS
67-64-1	Acetone	770	J	ug/kg dry	390	1200	100	EPA SW846-8260B	02/03/2012 16:33	02/03/2012 22:29	SS
71-43-2	Benzene	ND		ug/kg dry	60	580	100	EPA SW846-8260B	02/03/2012 16:33	02/03/2012 22:29	SS
108-86-1	Bromobenzene	ND		ug/kg dry	77	580	100	EPA SW846-8260B	02/03/2012 16:33	02/03/2012 22:29	SS
74-97-5	Bromochloromethane	ND		ug/kg dry	160	580	100	EPA SW846-8260B	02/03/2012 16:33	02/03/2012 22:29	SS
75-27-4	Bromodichloromethane	ND		ug/kg dry	78	580	100	EPA SW846-8260B	02/03/2012 16:33	02/03/2012 22:29	SS
75-25-2	Bromoform	ND		ug/kg dry	73	580	100	EPA SW846-8260B	02/03/2012 16:33	02/03/2012 22:29	SS
74-83-9	Bromomethane	480	J	ug/kg dry	160	580	100	EPA SW846-8260B	02/03/2012 16:33	02/03/2012 22:29	SS
56-23-5	Carbon tetrachloride	ND		ug/kg dry	130	580	100	EPA SW846-8260B	02/03/2012 16:33	02/03/2012 22:29	SS
108-90-7	Chlorobenzene	ND		ug/kg dry	44	580	100	EPA SW846-8260B	02/03/2012 16:33	02/03/2012 22:29	SS
75-00-3	Chloroethane	ND		ug/kg dry	96	580	100	EPA SW846-8260B	02/03/2012 16:33	02/03/2012 22:29	SS
67-66-3	Chloroform	ND		ug/kg dry	45	580	100	EPA SW846-8260B	02/03/2012 16:33	02/03/2012 22:29	SS
97-3	Chloromethane	ND		ug/kg dry	110	580	100	EPA SW846-8260B	02/03/2012 16:33	02/03/2012 22:29	SS
106-59-2	cis-1,2-Dichloroethylene	ND		ug/kg dry	120	580	100	EPA SW846-8260B	02/03/2012 16:33	02/03/2012 22:29	SS
10061-01-5	cis-1,3-Dichloropropylene	ND		ug/kg dry	44	580	100	EPA SW846-8260B	02/03/2012 16:33	02/03/2012 22:29	SS
124-48-1	Dibromochloromethane	ND		ug/kg dry	84	580	100	EPA SW846-8260B	02/03/2012 16:33	02/03/2012 22:29	SS
74-95-3	Dibromomethane	ND		ug/kg dry	170	580	100	EPA SW846-8260B	02/03/2012 16:33	02/03/2012 22:29	SS
75-71-8	Dichlorodifluoromethane	ND		ug/kg dry	100	580	100	EPA SW846-8260B	02/03/2012 16:33	02/03/2012 22:29	SS
100-41-4	Ethyl Benzene	ND		ug/kg dry	44	580	100	EPA SW846-8260B	02/03/2012 16:33	02/03/2012 22:29	SS
87-68-3	Hexachlorobutadiene	ND		ug/kg dry	54	580	100	EPA SW846-8260B	02/03/2012 16:33	02/03/2012 22:29	SS
98-82-8	Isopropylbenzene	ND		ug/kg dry	49	580	100	EPA SW846-8260B	02/03/2012 16:33	02/03/2012 22:29	SS
1634-04-4	Methyl tert-butyl ether (MTBE)	ND		ug/kg dry	48	580	100	EPA SW846-8260B	02/03/2012 16:33	02/03/2012 22:29	SS
75-09-2	Methylene chloride	620	J, B	ug/kg dry	130	1200	100	EPA SW846-8260B	02/03/2012 16:33	02/03/2012 22:29	SS
91-20-3	Naphthalene	ND		ug/kg dry	63	1200	100	EPA SW846-8260B	02/03/2012 16:33	02/03/2012 22:29	SS
104-51-8	n-Butylbenzene	250	J	ug/kg dry	40	580	100	EPA SW846-8260B	02/03/2012 16:33	02/03/2012 22:29	SS
103-65-1	n-Propylbenzene	98	J	ug/kg dry	73	580	100	EPA SW846-8260B	02/03/2012 16:33	02/03/2012 22:29	SS
95-47-6	o-Xylene	ND		ug/kg dry	63	580	100	EPA SW846-8260B	02/03/2012 16:33	02/03/2012 22:29	SS
1330-20-7P/M	p- & m- Xylenes	ND		ug/kg dry	69	1200	100	EPA SW846-8260B	02/03/2012 16:33	02/03/2012 22:29	SS
99-87-6	p-Isopropyltoluene	ND		ug/kg dry	31	580	100	EPA SW846-8260B	02/03/2012 16:33	02/03/2012 22:29	SS
135-98-8	sec-Butylbenzene	110	J	ug/kg dry	65	580	100	EPA SW846-8260B	02/03/2012 16:33	02/03/2012 22:29	SS
100-42-5	Styrene	ND		ug/kg dry	54	580	100	EPA SW846-8260B	02/03/2012 16:33	02/03/2012 22:29	SS
98-06-6	tert-Butylbenzene	ND		ug/kg dry	58	580	100	EPA SW846-8260B	02/03/2012 16:33	02/03/2012 22:29	SS
118-4	Tetrachloroethylene	ND		ug/kg dry	65	580	100	EPA SW846-8260B	02/03/2012 16:33	02/03/2012 22:29	SS
108-88-3	Toluene	ND		ug/kg dry	29	580	100	EPA SW846-8260B	02/03/2012 16:33	02/03/2012 22:29	SS
156-60-5	trans-1,2-Dichloroethylene	ND		ug/kg dry	82	580	100	EPA SW846-8260B	02/03/2012 16:33	02/03/2012 22:29	SS

YORK

ANALYTICAL LABORATORIES, INC.

Sample Information

Client Sample ID: 515W18-SB-2-8'-9'-Grab

York Sample ID: 12A0987-02

York Project (SDG) No.
12A0987

Client Project ID
515 West 18th St.

Matrix
Soil

Collection Date/Time
January 23, 2012 3:00 pm

Date Received
01/30/2012

Volatiles Organics, 8260 List

Log-in Notes:

Sample Notes:

Sample Prepared by Method: EPA 5035B

CAS No.	Parameter	Result	Flag	Units	MDL	RL	Dilution	Reference Method	Date/Time Prepared	Date/Time Analyzed	Analyst
10061-02-6	trans-1,3-Dichloropropylene	ND		ug/kg dry	86	580	100	EPA SW846-8260B	02/03/2012 16:33	02/03/2012 22:29	SS
79-01-6	Trichloroethylene	ND		ug/kg dry	72	580	100	EPA SW846-8260B	02/03/2012 16:33	02/03/2012 22:29	SS
75-69-4	Trichlorofluoromethane	ND		ug/kg dry	110	580	100	EPA SW846-8260B	02/03/2012 16:33	02/03/2012 22:29	SS
75-01-4	Vinyl Chloride	ND		ug/kg dry	120	580	100	EPA SW846-8260B	02/03/2012 16:33	02/03/2012 22:29	SS
1330-20-7	Xylenes, Total	ND		ug/kg dry	130	1700	100	EPA SW846-8260B	02/03/2012 16:33	02/03/2012 22:29	SS

Semi-Volatiles, 8270 Target List

Log-in Notes:

Sample Notes:

Sample Prepared by Method: EPA 3550B

CAS No.	Parameter	Result	Flag	Units	MDL	RL	Dilution	Reference Method	Date/Time Prepared	Date/Time Analyzed	Analyst
120-82-1	1,2,4-Trichlorobenzene	ND		ug/kg dry	106	194	1	EPA SW-846 8270C	02/03/2012 08:34	02/04/2012 00:32	TD
95-50-1	1,2-Dichlorobenzene	ND		ug/kg dry	85.0	194	1	EPA SW-846 8270C	02/03/2012 08:34	02/04/2012 00:32	TD
541-73-1	1,3-Dichlorobenzene	ND		ug/kg dry	92.5	194	1	EPA SW-846 8270C	02/03/2012 08:34	02/04/2012 00:32	TD
106-46-7	1,4-Dichlorobenzene	ND		ug/kg dry	66.6	194	1	EPA SW-846 8270C	02/03/2012 08:34	02/04/2012 00:32	TD
4	2,4,5-Trichlorophenol	ND		ug/kg dry	52.8	194	1	EPA SW-846 8270C	02/03/2012 08:34	02/04/2012 00:32	TD
88-06-2	2,4,6-Trichlorophenol	ND		ug/kg dry	95.0	194	1	EPA SW-846 8270C	02/03/2012 08:34	02/04/2012 00:32	TD
120-83-2	2,4-Dichlorophenol	ND		ug/kg dry	79.3	194	1	EPA SW-846 8270C	02/03/2012 08:34	02/04/2012 00:32	TD
105-67-9	2,4-Dimethylphenol	ND		ug/kg dry	62.3	194	1	EPA SW-846 8270C	02/03/2012 08:34	02/04/2012 00:32	TD
51-28-5	2,4-Dinitrophenol	ND		ug/kg dry	163	388	1	EPA SW-846 8270C	02/03/2012 08:34	02/04/2012 00:32	TD
121-14-2	2,4-Dinitrotoluene	ND		ug/kg dry	85.0	194	1	EPA SW-846 8270C	02/03/2012 08:34	02/04/2012 00:32	TD
606-20-2	2,6-Dinitrotoluene	ND		ug/kg dry	92.5	194	1	EPA SW-846 8270C	02/03/2012 08:34	02/04/2012 00:32	TD
91-58-7	2-Chloronaphthalene	ND		ug/kg dry	59.3	194	1	EPA SW-846 8270C	02/03/2012 08:34	02/04/2012 00:32	TD
95-57-8	2-Chlorophenol	ND		ug/kg dry	113	194	1	EPA SW-846 8270C	02/03/2012 08:34	02/04/2012 00:32	TD
91-57-6	2-Methylnaphthalene	ND		ug/kg dry	67.6	194	1	EPA SW-846 8270C	02/03/2012 08:34	02/04/2012 00:32	TD
95-48-7	2-Methylphenol	ND		ug/kg dry	71.5	194	1	EPA SW-846 8270C	02/03/2012 08:34	02/04/2012 00:32	TD
88-75-5	2-Nitrophenol	ND		ug/kg dry	66.6	194	1	EPA SW-846 8270C	02/03/2012 08:34	02/04/2012 00:32	TD
100-01-6	3- & 4-Methylphenols	ND		ug/kg dry	87.4	194	1	EPA SW-846 8270C	02/03/2012 08:34	02/04/2012 00:32	TD
91-94-1	3,3'-Dichlorobenzidine	ND		ug/kg dry	48.9	194	1	EPA SW-846 8270C	02/03/2012 08:34	02/04/2012 00:32	TD
99-09-2	3-Nitroaniline	ND		ug/kg dry	70.4	194	1	EPA SW-846 8270C	02/03/2012 08:34	02/04/2012 00:32	TD
534-52-1	4,6-Dinitro-2-methylphenol	ND		ug/kg dry	147	388	1	EPA SW-846 8270C	02/03/2012 08:34	02/04/2012 00:32	TD
101-55-3	4-Bromophenyl phenyl ether	ND		ug/kg dry	81.0	194	1	EPA SW-846 8270C	02/03/2012 08:34	02/04/2012 00:32	TD
59-50-7	4-Chloro-3-methylphenol	ND		ug/kg dry	20.9	194	1	EPA SW-846 8270C	02/03/2012 08:34	02/04/2012 00:32	TD
106-47-8	4-Chloroaniline	ND		ug/kg dry	76.7	194	1	EPA SW-846 8270C	02/03/2012 08:34	02/04/2012 00:32	TD
72-3	4-Chlorophenyl phenyl ether	ND		ug/kg dry	56.0	194	1	EPA SW-846 8270C	02/03/2012 08:34	02/04/2012 00:32	TD
100-02-7	4-Nitroaniline	ND		ug/kg dry	64.5	194	1	EPA SW-846 8270C	02/03/2012 08:34	02/04/2012 00:32	TD
56-57-5	4-Nitrophenol	ND		ug/kg dry	70.3	194	1	EPA SW-846 8270C	02/03/2012 08:34	02/04/2012 00:32	TD

YORK

ANALYTICAL LABORATORIES, INC.

Sample Information

Client Sample ID: **515W18-SB-2-8'-9'-Grab**

York Sample ID: **12A0987-02**

York Project (SDG) No.
12A0987

Client Project ID
515 West 18th St.

Matrix
Soil

Collection Date/Time
January 23, 2012 3:00 pm

Date Received
01/30/2012

Semi-Volatiles, 8270 Target List

Log-in Notes:

Sample Notes:

Sample Prepared by Method: EPA 3550B

CAS No.	Parameter	Result	Flag	Units	MDL	RL	Dilution	Reference Method	Date/Time Prepared	Date/Time Analyzed	Analyst
83-32-9	Acenaphthene	ND		ug/kg dry	113	194	1	EPA SW-846 8270C	02/03/2012 08:34	02/04/2012 00:32	TD
208-96-8	Acenaphthylene	ND		ug/kg dry	54.4	194	1	EPA SW-846 8270C	02/03/2012 08:34	02/04/2012 00:32	TD
62-53-3	Aniline	ND		ug/kg dry	69.9	194	1	EPA SW-846 8270C	02/03/2012 08:34	02/04/2012 00:32	TD
120-12-7	Anthracene	262		ug/kg dry	48.2	194	1	EPA SW-846 8270C	02/03/2012 08:34	02/04/2012 00:32	TD
56-55-3	Benzo(a)anthracene	ND		ug/kg dry	75.1	194	1	EPA SW-846 8270C	02/03/2012 08:34	02/04/2012 00:32	TD
50-32-8	Benzo(a)pyrene	ND		ug/kg dry	50.6	194	1	EPA SW-846 8270C	02/03/2012 08:34	02/04/2012 00:32	TD
205-99-2	Benzo(b)fluoranthene	ND		ug/kg dry	73.9	194	1	EPA SW-846 8270C	02/03/2012 08:34	02/04/2012 00:32	TD
191-24-2	Benzo(g,h,i)perylene	ND		ug/kg dry	58.4	194	1	EPA SW-846 8270C	02/03/2012 08:34	02/04/2012 00:32	TD
207-08-9	Benzo(k)fluoranthene	ND		ug/kg dry	75.2	194	1	EPA SW-846 8270C	02/03/2012 08:34	02/04/2012 00:32	TD
100-51-6	Benzyl alcohol	ND		ug/kg dry	62.9	194	1	EPA SW-846 8270C	02/03/2012 08:34	02/04/2012 00:32	TD
85-68-7	Benzyl butyl phthalate	ND		ug/kg dry	81.0	194	1	EPA SW-846 8270C	02/03/2012 08:34	02/04/2012 00:32	TD
111-91-1	Bis(2-chloroethoxy)methane	ND		ug/kg dry	71.6	194	1	EPA SW-846 8270C	02/03/2012 08:34	02/04/2012 00:32	TD
144-4	Bis(2-chloroethyl)ether	ND		ug/kg dry	66.0	194	1	EPA SW-846 8270C	02/03/2012 08:34	02/04/2012 00:32	TD
108-60-1	Bis(2-chloroisopropyl)ether	ND		ug/kg dry	72.1	194	1	EPA SW-846 8270C	02/03/2012 08:34	02/04/2012 00:32	TD
117-81-7	Bis(2-ethylhexyl)phthalate	ND		ug/kg dry	65.0	194	1	EPA SW-846 8270C	02/03/2012 08:34	02/04/2012 00:32	TD
218-01-9	Chrysene	ND		ug/kg dry	78.3	194	1	EPA SW-846 8270C	02/03/2012 08:34	02/04/2012 00:32	TD
53-70-3	Dibenzo(a,h)anthracene	ND		ug/kg dry	49.1	194	1	EPA SW-846 8270C	02/03/2012 08:34	02/04/2012 00:32	TD
132-64-9	Dibenzofuran	ND		ug/kg dry	62.7	194	1	EPA SW-846 8270C	02/03/2012 08:34	02/04/2012 00:32	TD
84-66-2	Diethyl phthalate	ND		ug/kg dry	102	194	1	EPA SW-846 8270C	02/03/2012 08:34	02/04/2012 00:32	TD
131-11-3	Dimethyl phthalate	ND		ug/kg dry	56.0	194	1	EPA SW-846 8270C	02/03/2012 08:34	02/04/2012 00:32	TD
84-74-2	Di-n-butyl phthalate	ND		ug/kg dry	58.0	194	1	EPA SW-846 8270C	02/03/2012 08:34	02/04/2012 00:32	TD
117-84-0	Di-n-octyl phthalate	ND		ug/kg dry	87.4	194	1	EPA SW-846 8270C	02/03/2012 08:34	02/04/2012 00:32	TD
206-44-0	Fluoranthene	115	J	ug/kg dry	113	194	1	EPA SW-846 8270C	02/03/2012 08:34	02/04/2012 00:32	TD
86-73-7	Fluorene	853		ug/kg dry	54.4	194	1	EPA SW-846 8270C	02/03/2012 08:34	02/04/2012 00:32	TD
118-74-1	Hexachlorobenzene	ND		ug/kg dry	31.7	194	1	EPA SW-846 8270C	02/03/2012 08:34	02/04/2012 00:32	TD
87-68-3	Hexachlorobutadiene	ND		ug/kg dry	77.7	194	1	EPA SW-846 8270C	02/03/2012 08:34	02/04/2012 00:32	TD
77-47-4	Hexachlorocyclopentadiene	ND		ug/kg dry	144	194	1	EPA SW-846 8270C	02/03/2012 08:34	02/04/2012 00:32	TD
67-72-1	Hexachloroethane	ND		ug/kg dry	69.9	194	1	EPA SW-846 8270C	02/03/2012 08:34	02/04/2012 00:32	TD
193-39-5	Indeno(1,2,3-cd)pyrene	ND		ug/kg dry	71.6	194	1	EPA SW-846 8270C	02/03/2012 08:34	02/04/2012 00:32	TD
78-59-1	Isophorone	ND		ug/kg dry	72.1	194	1	EPA SW-846 8270C	02/03/2012 08:34	02/04/2012 00:32	TD
91-20-3	Naphthalene	393		ug/kg dry	58.0	194	1	EPA SW-846 8270C	02/03/2012 08:34	02/04/2012 00:32	TD
99-95-3	Nitrobenzene	ND		ug/kg dry	87.4	194	1	EPA SW-846 8270C	02/03/2012 08:34	02/04/2012 00:32	TD
101-9	N-Nitrosodimethylamine	ND		ug/kg dry	70.3	194	1	EPA SW-846 8270C	02/03/2012 08:34	02/04/2012 00:32	TD
621-64-7	N-nitroso-di-n-propylamine	ND		ug/kg dry	50.7	194	1	EPA SW-846 8270C	02/03/2012 08:34	02/04/2012 00:32	TD
86-30-6	N-Nitrosodiphenylamine	ND		ug/kg dry	113	194	1	EPA SW-846 8270C	02/03/2012 08:34	02/04/2012 00:32	TD

YORK

ANALYTICAL LABORATORIES, INC.

Sample Information

Client Sample ID: 515W18-SB-2-8'-9'-Grab

York Sample ID: 12A0987-02

York Project (SDG) No.
12A0987

Client Project ID
515 West 18th St.

Matrix
Soil

Collection Date/Time
January 23, 2012 3:00 pm

Date Received
01/30/2012

Semi-Volatiles, 8270 Target List

Log-in Notes:

Sample Notes:

Sample Prepared by Method: EPA 3550B

CAS No.	Parameter	Result	Flag	Units	MDL	RL	Dilution	Reference Method	Date/Time Prepared	Date/Time Analyzed	Analyst
87-86-5	Pentachlorophenol	ND		ug/kg dry	54.4	194	1	EPA SW-846 8270C	02/03/2012 08:34	02/04/2012 00:32	TD
85-01-8	Phenanthrene	1560		ug/kg dry	71.7	194	1	EPA SW-846 8270C	02/03/2012 08:34	02/04/2012 00:32	TD
108-95-2	Phenol	ND		ug/kg dry	77.7	194	1	EPA SW-846 8270C	02/03/2012 08:34	02/04/2012 00:32	TD
129-00-0	Pyrene	244		ug/kg dry	69.7	194	1	EPA SW-846 8270C	02/03/2012 08:34	02/04/2012 00:32	TD
110-86-1	Pyridine	ND		ug/kg dry	75.9	194	1	EPA SW-846 8270C	02/03/2012 08:34	02/04/2012 00:32	TD

Total Solids

Log-in Notes:

Sample Notes:

Sample Prepared by Method: % Solids Prep

CAS No.	Parameter	Result	Flag	Units	MDL	RL	Dilution	Reference Method	Date/Time Prepared	Date/Time Analyzed	Analyst
solids	% Solids	85.8		%	0.100	0.100	1	SM 2540G	02/03/2012 14:33	02/03/2012 14:33	JCC

Sample Information

Client Sample ID: 515W18-SB-3-6'-6.5'-Grab

York Sample ID: 12A0987-03

York Project (SDG) No.
12A0987

Client Project ID
515 West 18th St.

Matrix
Soil

Collection Date/Time
January 25, 2012 3:00 pm

Date Received
01/30/2012

Volatile Organics, 8260 List

Log-in Notes:

Sample Notes:

Sample Prepared by Method: EPA 5035B

CAS No.	Parameter	Result	Flag	Units	MDL	RL	Dilution	Reference Method	Date/Time Prepared	Date/Time Analyzed	Analyst
630-20-6	1,1,1,2-Tetrachloroethane	ND		ug/kg dry	160	1400	250	EPA SW846-8260B	02/03/2012 16:33	02/03/2012 23:06	SS
71-55-6	1,1,1-Trichloroethane	ND		ug/kg dry	290	1400	250	EPA SW846-8260B	02/03/2012 16:33	02/03/2012 23:06	SS
79-34-5	1,1,2,2-Tetrachloroethane	ND		ug/kg dry	170	1400	250	EPA SW846-8260B	02/03/2012 16:33	02/03/2012 23:06	SS
76-13-1	1,1,2-Trichloro-1,2,2-trifluoroethane (Freon 113)	ND		ug/kg dry	180	1400	250	EPA SW846-8260B	02/03/2012 16:33	02/03/2012 23:06	SS
79-00-5	1,1,2-Trichloroethane	ND		ug/kg dry	180	1400	250	EPA SW846-8260B	02/03/2012 16:33	02/03/2012 23:06	SS
75-34-3	1,1-Dichloroethane	ND		ug/kg dry	210	1400	250	EPA SW846-8260B	02/03/2012 16:33	02/03/2012 23:06	SS
75-35-4	1,1-Dichloroethylene	ND		ug/kg dry	400	1400	250	EPA SW846-8260B	02/03/2012 16:33	02/03/2012 23:06	SS
563-58-6	1,1-Dichloropropylene	ND		ug/kg dry	130	1400	250	EPA SW846-8260B	02/03/2012 16:33	02/03/2012 23:06	SS
87-61-6	1,2,3-Trichlorobenzene	ND		ug/kg dry	110	2800	250	EPA SW846-8260B	02/03/2012 16:33	02/03/2012 23:06	SS
96-18-4	1,2,3-Trichloropropane	ND		ug/kg dry	340	1400	250	EPA SW846-8260B	02/03/2012 16:33	02/03/2012 23:06	SS
120-82-1	1,2,4-Trichlorobenzene	ND		ug/kg dry	150	2800	250	EPA SW846-8260B	02/03/2012 16:33	02/03/2012 23:06	SS
95-63-6	1,2,4-Trimethylbenzene	49000		ug/kg dry	160	1400	250	EPA SW846-8260B	02/03/2012 16:33	02/03/2012 23:06	SS
96-12-8	1,2-Dibromo-3-chloropropane	ND		ug/kg dry	400	2800	250	EPA SW846-8260B	02/03/2012 16:33	02/03/2012 23:06	SS
74-4	1,2-Dibromoethane	ND		ug/kg dry	210	1400	250	EPA SW846-8260B	02/03/2012 16:33	02/03/2012 23:06	SS
95-50-1	1,2-Dichlorobenzene	ND		ug/kg dry	180	1400	250	EPA SW846-8260B	02/03/2012 16:33	02/03/2012 23:06	SS
107-06-2	1,2-Dichloroethane	ND		ug/kg dry	200	1400	250	EPA SW846-8260B	02/03/2012 16:33	02/03/2012 23:06	SS

YORK

ANALYTICAL LABORATORIES, INC.

Sample Information

Client Sample ID: **515W18-SB-3-6'-6.5'-Grab**

York Sample ID: **12A0987-03**

York Project (SDG) No.
12A0987

Client Project ID
515 West 18th St.

Matrix
Soil

Collection Date/Time
January 25, 2012 3:00 pm

Date Received
01/30/2012

Volatiles Organics, 8260 List

Log-in Notes:

Sample Notes:

Sample Prepared by Method: EPA 5035B

CAS No.	Parameter	Result	Flag	Units	MDL	RL	Dilution	Reference Method	Date/Time Prepared	Date/Time Analyzed	Analyst
78-87-5	1,2-Dichloropropane	ND		ug/kg dry	67	1400	250	EPA SW846-8260B	02/03/2012 16:33	02/03/2012 23:06	SS
108-67-8	1,3,5-Trimethylbenzene	18000		ug/kg dry	110	1400	250	EPA SW846-8260B	02/03/2012 16:33	02/03/2012 23:06	SS
541-73-1	1,3-Dichlorobenzene	ND		ug/kg dry	140	1400	250	EPA SW846-8260B	02/03/2012 16:33	02/03/2012 23:06	SS
142-28-9	1,3-Dichloropropane	ND		ug/kg dry	210	1400	250	EPA SW846-8260B	02/03/2012 16:33	02/03/2012 23:06	SS
106-46-7	1,4-Dichlorobenzene	ND		ug/kg dry	210	1400	250	EPA SW846-8260B	02/03/2012 16:33	02/03/2012 23:06	SS
594-20-7	2,2-Dichloropropane	ND		ug/kg dry	290	1400	250	EPA SW846-8260B	02/03/2012 16:33	02/03/2012 23:06	SS
78-93-3	2-Butanone	ND		ug/kg dry	780	2800	250	EPA SW846-8260B	02/03/2012 16:33	02/03/2012 23:06	SS
95-49-8	2-Chlorotoluene	ND		ug/kg dry	150	1400	250	EPA SW846-8260B	02/03/2012 16:33	02/03/2012 23:06	SS
106-43-4	4-Chlorotoluene	ND		ug/kg dry	150	1400	250	EPA SW846-8260B	02/03/2012 16:33	02/03/2012 23:06	SS
67-64-1	Acetone	1600	J	ug/kg dry	940	2800	250	EPA SW846-8260B	02/03/2012 16:33	02/03/2012 23:06	SS
71-43-2	Benzene	ND		ug/kg dry	150	1400	250	EPA SW846-8260B	02/03/2012 16:33	02/03/2012 23:06	SS
108-86-1	Bromobenzene	ND		ug/kg dry	180	1400	250	EPA SW846-8260B	02/03/2012 16:33	02/03/2012 23:06	SS
7-5	Bromochloromethane	ND		ug/kg dry	390	1400	250	EPA SW846-8260B	02/03/2012 16:33	02/03/2012 23:06	SS
109-27-4	Bromodichloromethane	ND		ug/kg dry	190	1400	250	EPA SW846-8260B	02/03/2012 16:33	02/03/2012 23:06	SS
75-25-2	Bromoform	ND		ug/kg dry	180	1400	250	EPA SW846-8260B	02/03/2012 16:33	02/03/2012 23:06	SS
74-83-9	Bromomethane	ND		ug/kg dry	380	1400	250	EPA SW846-8260B	02/03/2012 16:33	02/03/2012 23:06	SS
56-23-5	Carbon tetrachloride	ND		ug/kg dry	310	1400	250	EPA SW846-8260B	02/03/2012 16:33	02/03/2012 23:06	SS
108-90-7	Chlorobenzene	ND		ug/kg dry	110	1400	250	EPA SW846-8260B	02/03/2012 16:33	02/03/2012 23:06	SS
75-00-3	Chloroethane	ND		ug/kg dry	230	1400	250	EPA SW846-8260B	02/03/2012 16:33	02/03/2012 23:06	SS
67-66-3	Chloroform	ND		ug/kg dry	110	1400	250	EPA SW846-8260B	02/03/2012 16:33	02/03/2012 23:06	SS
74-87-3	Chloromethane	ND		ug/kg dry	270	1400	250	EPA SW846-8260B	02/03/2012 16:33	02/03/2012 23:06	SS
156-59-2	cis-1,2-Dichloroethylene	ND		ug/kg dry	290	1400	250	EPA SW846-8260B	02/03/2012 16:33	02/03/2012 23:06	SS
10061-01-5	cis-1,3-Dichloropropylene	ND		ug/kg dry	110	1400	250	EPA SW846-8260B	02/03/2012 16:33	02/03/2012 23:06	SS
124-48-1	Dibromochloromethane	ND		ug/kg dry	200	1400	250	EPA SW846-8260B	02/03/2012 16:33	02/03/2012 23:06	SS
74-95-3	Dibromomethane	ND		ug/kg dry	400	1400	250	EPA SW846-8260B	02/03/2012 16:33	02/03/2012 23:06	SS
75-71-8	Dichlorodifluoromethane	ND		ug/kg dry	250	1400	250	EPA SW846-8260B	02/03/2012 16:33	02/03/2012 23:06	SS
100-41-4	Ethyl Benzene	7400		ug/kg dry	110	1400	250	EPA SW846-8260B	02/03/2012 16:33	02/03/2012 23:06	SS
87-68-3	Hexachlorobutadiene	ND		ug/kg dry	130	1400	250	EPA SW846-8260B	02/03/2012 16:33	02/03/2012 23:06	SS
98-82-8	Isopropylbenzene	2300		ug/kg dry	120	1400	250	EPA SW846-8260B	02/03/2012 16:33	02/03/2012 23:06	SS
1634-04-4	Methyl tert-butyl ether (MTBE)	ND		ug/kg dry	110	1400	250	EPA SW846-8260B	02/03/2012 16:33	02/03/2012 23:06	SS
75-09-2	Methylene chloride	1200	J, B	ug/kg dry	320	2800	250	EPA SW846-8260B	02/03/2012 16:33	02/03/2012 23:06	SS
91-20-3	Naphthalene	20000		ug/kg dry	150	2800	250	EPA SW846-8260B	02/03/2012 16:33	02/03/2012 23:06	SS
100-11-8	n-Butylbenzene	5900		ug/kg dry	97	1400	250	EPA SW846-8260B	02/03/2012 16:33	02/03/2012 23:06	SS
103-65-1	n-Propylbenzene	5500		ug/kg dry	180	1400	250	EPA SW846-8260B	02/03/2012 16:33	02/03/2012 23:06	SS
95-47-6	o-Xylene	20000		ug/kg dry	150	1400	250	EPA SW846-8260B	02/03/2012 16:33	02/03/2012 23:06	SS

YORK

ANALYTICAL LABORATORIES, INC.

Sample Information

Client Sample ID: 515W18-SB-3-6'-6.5'-Grab

York Sample ID: 12A0987-03

York Project (SDG) No.
12A0987

Client Project ID
515 West 18th St.

Matrix
Soil

Collection Date/Time
January 25, 2012 3:00 pm

Date Received
01/30/2012

Volatile Organics, 8260 List

Log-in Notes:

Sample Notes:

Sample Prepared by Method: EPA 5035B

CAS No.	Parameter	Result	Flag	Units	MDL	RL	Dilution	Reference Method	Date/Time Prepared	Date/Time Analyzed	Analyst
1330-20-7P/M	p- & m- Xylenes	48000		ug/kg dry	170	2800	250	EPA SW846-8260B	02/03/2012 16:33	02/03/2012 23:06	SS
99-87-6	p-Isopropyltoluene	1300	J	ug/kg dry	76	1400	250	EPA SW846-8260B	02/03/2012 16:33	02/03/2012 23:06	SS
135-98-8	sec-Butylbenzene	1400		ug/kg dry	160	1400	250	EPA SW846-8260B	02/03/2012 16:33	02/03/2012 23:06	SS
100-42-5	Styrene	ND		ug/kg dry	130	1400	250	EPA SW846-8260B	02/03/2012 16:33	02/03/2012 23:06	SS
98-06-6	tert-Butylbenzene	ND		ug/kg dry	140	1400	250	EPA SW846-8260B	02/03/2012 16:33	02/03/2012 23:06	SS
127-18-4	Tetrachloroethylene	ND		ug/kg dry	160	1400	250	EPA SW846-8260B	02/03/2012 16:33	02/03/2012 23:06	SS
108-88-3	Toluene	1200	J	ug/kg dry	70	1400	250	EPA SW846-8260B	02/03/2012 16:33	02/03/2012 23:06	SS
156-60-5	trans-1,2-Dichloroethylene	ND		ug/kg dry	200	1400	250	EPA SW846-8260B	02/03/2012 16:33	02/03/2012 23:06	SS
10061-02-6	trans-1,3-Dichloropropylene	ND		ug/kg dry	210	1400	250	EPA SW846-8260B	02/03/2012 16:33	02/03/2012 23:06	SS
79-01-6	Trichloroethylene	ND		ug/kg dry	170	1400	250	EPA SW846-8260B	02/03/2012 16:33	02/03/2012 23:06	SS
75-69-4	Trichlorofluoromethane	ND		ug/kg dry	280	1400	250	EPA SW846-8260B	02/03/2012 16:33	02/03/2012 23:06	SS
75-01-4	Vinyl Chloride	ND		ug/kg dry	290	1400	250	EPA SW846-8260B	02/03/2012 16:33	02/03/2012 23:06	SS
100-20-7	Xylenes, Total	68000		ug/kg dry	320	4200	250	EPA SW846-8260B	02/03/2012 16:33	02/03/2012 23:06	SS

Semi-Volatiles, 8270 Target List

Log-in Notes:

Sample Notes:

Sample Prepared by Method: EPA 3550B

CAS No.	Parameter	Result	Flag	Units	MDL	RL	Dilution	Reference Method	Date/Time Prepared	Date/Time Analyzed	Analyst
120-82-1	1,2,4-Trichlorobenzene	ND		ug/kg dry	2040	3740	20	EPA SW-846 8270C	02/03/2012 08:34	02/06/2012 11:57	TD
95-50-1	1,2-Dichlorobenzene	ND		ug/kg dry	1630	3740	20	EPA SW-846 8270C	02/03/2012 08:34	02/06/2012 11:57	TD
541-73-1	1,3-Dichlorobenzene	ND		ug/kg dry	1780	3740	20	EPA SW-846 8270C	02/03/2012 08:34	02/06/2012 11:57	TD
106-46-7	1,4-Dichlorobenzene	ND		ug/kg dry	1280	3740	20	EPA SW-846 8270C	02/03/2012 08:34	02/06/2012 11:57	TD
95-95-4	2,4,5-Trichlorophenol	ND		ug/kg dry	1020	3740	20	EPA SW-846 8270C	02/03/2012 08:34	02/06/2012 11:57	TD
88-06-2	2,4,6-Trichlorophenol	ND		ug/kg dry	1830	3740	20	EPA SW-846 8270C	02/03/2012 08:34	02/06/2012 11:57	TD
120-83-2	2,4-Dichlorophenol	ND		ug/kg dry	1530	3740	20	EPA SW-846 8270C	02/03/2012 08:34	02/06/2012 11:57	TD
105-67-9	2,4-Dimethylphenol	ND		ug/kg dry	1200	3740	20	EPA SW-846 8270C	02/03/2012 08:34	02/06/2012 11:57	TD
51-28-5	2,4-Dinitrophenol	ND		ug/kg dry	3140	7470	20	EPA SW-846 8270C	02/03/2012 08:34	02/06/2012 11:57	TD
121-14-2	2,4-Dinitrotoluene	ND		ug/kg dry	1630	3740	20	EPA SW-846 8270C	02/03/2012 08:34	02/06/2012 11:57	TD
606-20-2	2,6-Dinitrotoluene	ND		ug/kg dry	1780	3740	20	EPA SW-846 8270C	02/03/2012 08:34	02/06/2012 11:57	TD
91-58-7	2-Chloronaphthalene	ND		ug/kg dry	1140	3740	20	EPA SW-846 8270C	02/03/2012 08:34	02/06/2012 11:57	TD
95-57-8	2-Chlorophenol	ND		ug/kg dry	2180	3740	20	EPA SW-846 8270C	02/03/2012 08:34	02/06/2012 11:57	TD
91-57-6	2-Methylnaphthalene	15100		ug/kg dry	1300	3740	20	EPA SW-846 8270C	02/03/2012 08:34	02/06/2012 11:57	TD
95-48-7	2-Methylphenol	ND		ug/kg dry	1370	3740	20	EPA SW-846 8270C	02/03/2012 08:34	02/06/2012 11:57	TD
100-75-5	2-Nitrophenol	ND		ug/kg dry	1280	3740	20	EPA SW-846 8270C	02/03/2012 08:34	02/06/2012 11:57	TD
100-101-6	3- & 4-Methylphenols	ND		ug/kg dry	1680	3740	20	EPA SW-846 8270C	02/03/2012 08:34	02/06/2012 11:57	TD
91-94-1	3,3'-Dichlorobenzidine	ND		ug/kg dry	941	3740	20	EPA SW-846 8270C	02/03/2012 08:34	02/06/2012 11:57	TD
99-09-2	3-Nitroaniline	ND		ug/kg dry	1350	3740	20	EPA SW-846 8270C	02/03/2012 08:34	02/06/2012 11:57	TD

YORK

ANALYTICAL LABORATORIES, INC.

Sample Information

Client Sample ID: 515W18-SB-3-6'-6.5'-Grab

York Sample ID: 12A0987-03

York Project (SDG) No.
12A0987

Client Project ID
515 West 18th St.

Matrix
Soil

Collection Date/Time
January 25, 2012 3:00 pm

Date Received
01/30/2012

Semi-Volatiles, 8270 Target List

Sample Prepared by Method: EPA 3550B

Log-in Notes:

Sample Notes:

CAS No.	Parameter	Result	Flag	Units	MDL	RL	Dilution	Reference Method	Date/Time Prepared	Date/Time Analyzed	Analyst
534-52-1	4,6-Dinitro-2-methylphenol	ND		ug/kg dry	2820	7470	20	EPA SW-846 8270C	02/03/2012 08:34	02/06/2012 11:57	TD
101-55-3	4-Bromophenyl phenyl ether	ND		ug/kg dry	1560	3740	20	EPA SW-846 8270C	02/03/2012 08:34	02/06/2012 11:57	TD
59-50-7	4-Chloro-3-methylphenol	ND		ug/kg dry	403	3740	20	EPA SW-846 8270C	02/03/2012 08:34	02/06/2012 11:57	TD
106-47-8	4-Chloroaniline	ND		ug/kg dry	1480	3740	20	EPA SW-846 8270C	02/03/2012 08:34	02/06/2012 11:57	TD
7005-72-3	4-Chlorophenyl phenyl ether	ND		ug/kg dry	1080	3740	20	EPA SW-846 8270C	02/03/2012 08:34	02/06/2012 11:57	TD
100-02-7	4-Nitroaniline	ND		ug/kg dry	1240	3740	20	EPA SW-846 8270C	02/03/2012 08:34	02/06/2012 11:57	TD
56-57-5	4-Nitrophenol	ND		ug/kg dry	1350	3740	20	EPA SW-846 8270C	02/03/2012 08:34	02/06/2012 11:57	TD
83-32-9	Acenaphthene	ND		ug/kg dry	2160	3740	20	EPA SW-846 8270C	02/03/2012 08:34	02/06/2012 11:57	TD
208-96-8	Acenaphthylene	ND		ug/kg dry	1050	3740	20	EPA SW-846 8270C	02/03/2012 08:34	02/06/2012 11:57	TD
62-53-3	Aniline	ND		ug/kg dry	1340	3740	20	EPA SW-846 8270C	02/03/2012 08:34	02/06/2012 11:57	TD
120-12-7	Anthracene	ND		ug/kg dry	926	3740	20	EPA SW-846 8270C	02/03/2012 08:34	02/06/2012 11:57	TD
56-55-3	Benzo(a)anthracene	ND		ug/kg dry	1450	3740	20	EPA SW-846 8270C	02/03/2012 08:34	02/06/2012 11:57	TD
128-85-8	Benzo(a)pyrene	ND		ug/kg dry	974	3740	20	EPA SW-846 8270C	02/03/2012 08:34	02/06/2012 11:57	TD
205-99-2	Benzo(b)fluoranthene	ND		ug/kg dry	1420	3740	20	EPA SW-846 8270C	02/03/2012 08:34	02/06/2012 11:57	TD
191-24-2	Benzo(g,h,i)perylene	ND		ug/kg dry	1120	3740	20	EPA SW-846 8270C	02/03/2012 08:34	02/06/2012 11:57	TD
207-08-9	Benzo(k)fluoranthene	ND		ug/kg dry	1450	3740	20	EPA SW-846 8270C	02/03/2012 08:34	02/06/2012 11:57	TD
100-51-6	Benzyl alcohol	ND		ug/kg dry	1210	3740	20	EPA SW-846 8270C	02/03/2012 08:34	02/06/2012 11:57	TD
85-68-7	Benzyl butyl phthalate	ND		ug/kg dry	1560	3740	20	EPA SW-846 8270C	02/03/2012 08:34	02/06/2012 11:57	TD
111-91-1	Bis(2-chloroethoxy)methane	ND		ug/kg dry	1380	3740	20	EPA SW-846 8270C	02/03/2012 08:34	02/06/2012 11:57	TD
111-44-4	Bis(2-chloroethyl)ether	ND		ug/kg dry	1270	3740	20	EPA SW-846 8270C	02/03/2012 08:34	02/06/2012 11:57	TD
108-60-1	Bis(2-chloroisopropyl)ether	ND		ug/kg dry	1390	3740	20	EPA SW-846 8270C	02/03/2012 08:34	02/06/2012 11:57	TD
117-81-7	Bis(2-ethylhexyl)phthalate	ND		ug/kg dry	1250	3740	20	EPA SW-846 8270C	02/03/2012 08:34	02/06/2012 11:57	TD
218-01-9	Chrysene	ND		ug/kg dry	1510	3740	20	EPA SW-846 8270C	02/03/2012 08:34	02/06/2012 11:57	TD
53-70-3	Dibenzo(a,h)anthracene	ND		ug/kg dry	944	3740	20	EPA SW-846 8270C	02/03/2012 08:34	02/06/2012 11:57	TD
132-64-9	Dibenzofuran	ND		ug/kg dry	1210	3740	20	EPA SW-846 8270C	02/03/2012 08:34	02/06/2012 11:57	TD
84-66-2	Diethyl phthalate	ND		ug/kg dry	1960	3740	20	EPA SW-846 8270C	02/03/2012 08:34	02/06/2012 11:57	TD
131-11-3	Dimethyl phthalate	ND		ug/kg dry	1080	3740	20	EPA SW-846 8270C	02/03/2012 08:34	02/06/2012 11:57	TD
84-74-2	Di-n-butyl phthalate	ND		ug/kg dry	1120	3740	20	EPA SW-846 8270C	02/03/2012 08:34	02/06/2012 11:57	TD
117-84-0	Di-n-octyl phthalate	ND		ug/kg dry	1680	3740	20	EPA SW-846 8270C	02/03/2012 08:34	02/06/2012 11:57	TD
206-44-0	Fluoranthene	ND		ug/kg dry	2160	3740	20	EPA SW-846 8270C	02/03/2012 08:34	02/06/2012 11:57	TD
86-73-7	Fluorene	ND		ug/kg dry	1050	3740	20	EPA SW-846 8270C	02/03/2012 08:34	02/06/2012 11:57	TD
74-1	Hexachlorobenzene	ND		ug/kg dry	609	3740	20	EPA SW-846 8270C	02/03/2012 08:34	02/06/2012 11:57	TD
67-58-3	Hexachlorobutadiene	ND		ug/kg dry	1490	3740	20	EPA SW-846 8270C	02/03/2012 08:34	02/06/2012 11:57	TD
77-47-4	Hexachlorocyclopentadiene	ND		ug/kg dry	2780	3740	20	EPA SW-846 8270C	02/03/2012 08:34	02/06/2012 11:57	TD
67-72-1	Hexachloroethane	ND		ug/kg dry	1340	3740	20	EPA SW-846 8270C	02/03/2012 08:34	02/06/2012 11:57	TD

YORK

ANALYTICAL LABORATORIES, INC.

Sample Information

Client Sample ID: 515W18-SB-3-6'-6.5'-Grab

York Sample ID: 12A0987-03

York Project (SDG) No.
12A0987

Client Project ID
515 West 18th St.

Matrix
Soil

Collection Date/Time
January 25, 2012 3:00 pm

Date Received
01/30/2012

Semi-Volatiles, 8270 Target List

Log-in Notes:

Sample Notes:

Sample Prepared by Method: EPA 3550B

CAS No.	Parameter	Result	Flag	Units	MDL	RL	Dilution	Reference Method	Date/Time Prepared	Date/Time Analyzed	Analyst
193-39-5	Indeno(1,2,3-cd)pyrene	ND		ug/kg dry	1380	3740	20	EPA SW-846 8270C	02/03/2012 08:34	02/06/2012 11:57	TD
78-59-1	Isophorone	ND		ug/kg dry	1390	3740	20	EPA SW-846 8270C	02/03/2012 08:34	02/06/2012 11:57	TD
91-20-3	Naphthalene	8480		ug/kg dry	1120	3740	20	EPA SW-846 8270C	02/03/2012 08:34	02/06/2012 11:57	TD
98-95-3	Nitrobenzene	ND		ug/kg dry	1680	3740	20	EPA SW-846 8270C	02/03/2012 08:34	02/06/2012 11:57	TD
62-75-9	N-Nitrosodimethylamine	ND		ug/kg dry	1350	3740	20	EPA SW-846 8270C	02/03/2012 08:34	02/06/2012 11:57	TD
621-64-7	N-nitroso-di-n-propylamine	ND		ug/kg dry	975	3740	20	EPA SW-846 8270C	02/03/2012 08:34	02/06/2012 11:57	TD
86-30-6	N-Nitrosodiphenylamine	ND		ug/kg dry	2160	3740	20	EPA SW-846 8270C	02/03/2012 08:34	02/06/2012 11:57	TD
87-86-5	Pentachlorophenol	ND		ug/kg dry	1050	3740	20	EPA SW-846 8270C	02/03/2012 08:34	02/06/2012 11:57	TD
85-01-8	Phenanthrene	1820	J	ug/kg dry	1380	3740	20	EPA SW-846 8270C	02/03/2012 08:34	02/06/2012 11:57	TD
108-95-2	Phenol	ND		ug/kg dry	1490	3740	20	EPA SW-846 8270C	02/03/2012 08:34	02/06/2012 11:57	TD
129-00-0	Pyrene	ND		ug/kg dry	1340	3740	20	EPA SW-846 8270C	02/03/2012 08:34	02/06/2012 11:57	TD
110-86-1	Pyridine	ND		ug/kg dry	1460	3740	20	EPA SW-846 8270C	02/03/2012 08:34	02/06/2012 11:57	TD

Total Solids

Log-in Notes:

Sample Notes:

Sample Prepared by Method: % Solids Prep

CAS No.	Parameter	Result	Flag	Units	MDL	RL	Dilution	Reference Method	Date/Time Prepared	Date/Time Analyzed	Analyst
solids	% Solids	89.2		%	0.100	0.100	1	SM 2540G	02/03/2012 14:33	02/03/2012 14:33	JCC

Sample Information

Client Sample ID: 515W18-SB-4-7'-8'-Grab

York Sample ID: 12A0987-04

York Project (SDG) No.
12A0987

Client Project ID
515 West 18th St.

Matrix
Soil

Collection Date/Time
January 27, 2012 3:00 pm

Date Received
01/30/2012

Volatile Organics, 8260 List

Log-in Notes:

Sample Notes:

Sample Prepared by Method: EPA 5035B

CAS No.	Parameter	Result	Flag	Units	MDL	RL	Dilution	Reference Method	Date/Time Prepared	Date/Time Analyzed	Analyst
630-20-6	1,1,1,2-Tetrachloroethane	ND		ug/kg dry	67	570	100	EPA SW846-8260B	02/03/2012 16:33	02/03/2012 23:42	SS
71-55-6	1,1,1-Trichloroethane	ND		ug/kg dry	120	570	100	EPA SW846-8260B	02/03/2012 16:33	02/03/2012 23:42	SS
79-34-5	1,1,2,2-Tetrachloroethane	ND		ug/kg dry	70	570	100	EPA SW846-8260B	02/03/2012 16:33	02/03/2012 23:42	SS
76-13-1	1,1,2-Trichloro-1,2,2-trifluoroethane (Freon 113)	ND		ug/kg dry	74	570	100	EPA SW846-8260B	02/03/2012 16:33	02/03/2012 23:42	SS
79-00-5	1,1,2-Trichloroethane	ND		ug/kg dry	75	570	100	EPA SW846-8260B	02/03/2012 16:33	02/03/2012 23:42	SS
75-34-3	1,1-Dichloroethane	ND		ug/kg dry	85	570	100	EPA SW846-8260B	02/03/2012 16:33	02/03/2012 23:42	SS
-4	1,1-Dichloroethylene	ND		ug/kg dry	160	570	100	EPA SW846-8260B	02/03/2012 16:33	02/03/2012 23:42	SS
563-58-6	1,1-Dichloropropylene	ND		ug/kg dry	53	570	100	EPA SW846-8260B	02/03/2012 16:33	02/03/2012 23:42	SS
87-61-6	1,2,3-Trichlorobenzene	ND		ug/kg dry	46	1100	100	EPA SW846-8260B	02/03/2012 16:33	02/03/2012 23:42	SS

YORK

ANALYTICAL LABORATORIES, INC.

Sample Information

Client Sample ID: 515W18-SB-4-7'-8'-Grab

York Sample ID: 12A0987-04

York Project (SDG) No.
12A0987

Client Project ID
515 West 18th St.

Matrix
Soil

Collection Date/Time
January 27, 2012 3:00 pm

Date Received
01/30/2012

Volatiles Organics, 8260 List

Log-in Notes:

Sample Notes:

Sample Prepared by Method: EPA 5035B

CAS No.	Parameter	Result	Flag	Units	MDL	RL	Dilution	Reference Method	Date/Time Prepared	Date/Time Analyzed	Analyst
96-18-4	1,2,3-Trichloropropane	ND		ug/kg dry	140	570	100	EPA SW846-8260B	02/03/2012 16:33	02/03/2012 23:42	SS
120-82-1	1,2,4-Trichlorobenzene	ND		ug/kg dry	59	1100	100	EPA SW846-8260B	02/03/2012 16:33	02/03/2012 23:42	SS
95-63-6	1,2,4-Trimethylbenzene	130	J	ug/kg dry	65	570	100	EPA SW846-8260B	02/03/2012 16:33	02/03/2012 23:42	SS
96-12-8	1,2-Dibromo-3-chloropropane	ND		ug/kg dry	160	1100	100	EPA SW846-8260B	02/03/2012 16:33	02/03/2012 23:42	SS
106-93-4	1,2-Dibromoethane	ND		ug/kg dry	84	570	100	EPA SW846-8260B	02/03/2012 16:33	02/03/2012 23:42	SS
95-50-1	1,2-Dichlorobenzene	ND		ug/kg dry	73	570	100	EPA SW846-8260B	02/03/2012 16:33	02/03/2012 23:42	SS
107-06-2	1,2-Dichloroethane	ND		ug/kg dry	80	570	100	EPA SW846-8260B	02/03/2012 16:33	02/03/2012 23:42	SS
78-87-5	1,2-Dichloropropane	ND		ug/kg dry	27	570	100	EPA SW846-8260B	02/03/2012 16:33	02/03/2012 23:42	SS
108-67-8	1,3,5-Trimethylbenzene	ND		ug/kg dry	46	570	100	EPA SW846-8260B	02/03/2012 16:33	02/03/2012 23:42	SS
541-73-1	1,3-Dichlorobenzene	ND		ug/kg dry	58	570	100	EPA SW846-8260B	02/03/2012 16:33	02/03/2012 23:42	SS
142-28-9	1,3-Dichloropropane	ND		ug/kg dry	85	570	100	EPA SW846-8260B	02/03/2012 16:33	02/03/2012 23:42	SS
106-46-7	1,4-Dichlorobenzene	ND		ug/kg dry	84	570	100	EPA SW846-8260B	02/03/2012 16:33	02/03/2012 23:42	SS
70-7	2,2-Dichloropropane	ND		ug/kg dry	120	570	100	EPA SW846-8260B	02/03/2012 16:33	02/03/2012 23:42	SS
70-93-3	2-Butanone	ND		ug/kg dry	320	1100	100	EPA SW846-8260B	02/03/2012 16:33	02/03/2012 23:42	SS
95-49-8	2-Chlorotoluene	ND		ug/kg dry	61	570	100	EPA SW846-8260B	02/03/2012 16:33	02/03/2012 23:42	SS
106-43-4	4-Chlorotoluene	ND		ug/kg dry	61	570	100	EPA SW846-8260B	02/03/2012 16:33	02/03/2012 23:42	SS
67-64-1	Acetone	840	J	ug/kg dry	380	1100	100	EPA SW846-8260B	02/03/2012 16:33	02/03/2012 23:42	SS
71-43-2	Benzene	ND		ug/kg dry	59	570	100	EPA SW846-8260B	02/03/2012 16:33	02/03/2012 23:42	SS
108-86-1	Bromobenzene	ND		ug/kg dry	75	570	100	EPA SW846-8260B	02/03/2012 16:33	02/03/2012 23:42	SS
74-97-5	Bromochloromethane	ND		ug/kg dry	160	570	100	EPA SW846-8260B	02/03/2012 16:33	02/03/2012 23:42	SS
75-27-4	Bromodichloromethane	ND		ug/kg dry	77	570	100	EPA SW846-8260B	02/03/2012 16:33	02/03/2012 23:42	SS
75-25-2	Bromoform	ND		ug/kg dry	72	570	100	EPA SW846-8260B	02/03/2012 16:33	02/03/2012 23:42	SS
74-83-9	Bromomethane	610		ug/kg dry	150	570	100	EPA SW846-8260B	02/03/2012 16:33	02/03/2012 23:42	SS
56-23-5	Carbon tetrachloride	ND		ug/kg dry	130	570	100	EPA SW846-8260B	02/03/2012 16:33	02/03/2012 23:42	SS
108-90-7	Chlorobenzene	ND		ug/kg dry	43	570	100	EPA SW846-8260B	02/03/2012 16:33	02/03/2012 23:42	SS
75-00-3	Chloroethane	ND		ug/kg dry	94	570	100	EPA SW846-8260B	02/03/2012 16:33	02/03/2012 23:42	SS
67-66-3	Chloroform	ND		ug/kg dry	44	570	100	EPA SW846-8260B	02/03/2012 16:33	02/03/2012 23:42	SS
74-87-3	Chloromethane	ND		ug/kg dry	110	570	100	EPA SW846-8260B	02/03/2012 16:33	02/03/2012 23:42	SS
156-59-2	cis-1,2-Dichloroethylene	ND		ug/kg dry	120	570	100	EPA SW846-8260B	02/03/2012 16:33	02/03/2012 23:42	SS
10061-01-5	cis-1,3-Dichloropropylene	ND		ug/kg dry	43	570	100	EPA SW846-8260B	02/03/2012 16:33	02/03/2012 23:42	SS
124-48-1	Dibromochloromethane	ND		ug/kg dry	83	570	100	EPA SW846-8260B	02/03/2012 16:33	02/03/2012 23:42	SS
74-95-3	Dibromomethane	ND		ug/kg dry	160	570	100	EPA SW846-8260B	02/03/2012 16:33	02/03/2012 23:42	SS
74-11-8	Dichlorodifluoromethane	ND		ug/kg dry	100	570	100	EPA SW846-8260B	02/03/2012 16:33	02/03/2012 23:42	SS
100-41-4	Ethyl Benzene	ND		ug/kg dry	43	570	100	EPA SW846-8260B	02/03/2012 16:33	02/03/2012 23:42	SS
87-68-3	Hexachlorobutadiene	ND		ug/kg dry	53	570	100	EPA SW846-8260B	02/03/2012 16:33	02/03/2012 23:42	SS

YORK

ANALYTICAL LABORATORIES, INC.

Sample Information

Client Sample ID: 515W18-SB-4-7'-8'-Grab

York Sample ID: 12A0987-04

York Project (SDG) No.
12A0987

Client Project ID
515 West 18th St.

Matrix
Soil

Collection Date/Time
January 27, 2012 3:00 pm

Date Received
01/30/2012

Volatile Organics, 8260 List

Log-in Notes:

Sample Notes:

Sample Prepared by Method: EPA 5035B

CAS No.	Parameter	Result	Flag	Units	MDL	RL	Dilution	Reference Method	Date/Time Prepared	Date/Time Analyzed	Analyst
98-82-8	Isopropylbenzene	140	J	ug/kg dry	48	570	100	EPA SW846-8260B	02/03/2012 16:33	02/03/2012 23:42	SS
1634-04-4	Methyl tert-butyl ether (MTBE)	ND		ug/kg dry	47	570	100	EPA SW846-8260B	02/03/2012 16:33	02/03/2012 23:42	SS
75-09-2	Methylene chloride	570	J, B	ug/kg dry	130	1100	100	EPA SW846-8260B	02/03/2012 16:33	02/03/2012 23:42	SS
91-20-3	Naphthalene	ND		ug/kg dry	62	1100	100	EPA SW846-8260B	02/03/2012 16:33	02/03/2012 23:42	SS
104-51-8	n-Butylbenzene	440	J	ug/kg dry	40	570	100	EPA SW846-8260B	02/03/2012 16:33	02/03/2012 23:42	SS
103-65-1	n-Propylbenzene	150	J	ug/kg dry	72	570	100	EPA SW846-8260B	02/03/2012 16:33	02/03/2012 23:42	SS
95-47-6	o-Xylene	ND		ug/kg dry	62	570	100	EPA SW846-8260B	02/03/2012 16:33	02/03/2012 23:42	SS
1330-20-7P/M	p- & m- Xylenes	200	J	ug/kg dry	68	1100	100	EPA SW846-8260B	02/03/2012 16:33	02/03/2012 23:42	SS
99-87-6	p-Isopropyltoluene	ND		ug/kg dry	31	570	100	EPA SW846-8260B	02/03/2012 16:33	02/03/2012 23:42	SS
135-98-8	sec-Butylbenzene	360	J	ug/kg dry	64	570	100	EPA SW846-8260B	02/03/2012 16:33	02/03/2012 23:42	SS
100-42-5	Styrene	ND		ug/kg dry	53	570	100	EPA SW846-8260B	02/03/2012 16:33	02/03/2012 23:42	SS
98-06-6	tert-Butylbenzene	ND		ug/kg dry	57	570	100	EPA SW846-8260B	02/03/2012 16:33	02/03/2012 23:42	SS
177-18-4	Tetrachloroethylene	ND		ug/kg dry	64	570	100	EPA SW846-8260B	02/03/2012 16:33	02/03/2012 23:42	SS
68-3	Toluene	ND		ug/kg dry	28	570	100	EPA SW846-8260B	02/03/2012 16:33	02/03/2012 23:42	SS
156-60-5	trans-1,2-Dichloroethylene	ND		ug/kg dry	80	570	100	EPA SW846-8260B	02/03/2012 16:33	02/03/2012 23:42	SS
10061-02-6	trans-1,3-Dichloropropylene	ND		ug/kg dry	84	570	100	EPA SW846-8260B	02/03/2012 16:33	02/03/2012 23:42	SS
79-01-6	Trichloroethylene	ND		ug/kg dry	70	570	100	EPA SW846-8260B	02/03/2012 16:33	02/03/2012 23:42	SS
75-69-4	Trichlorofluoromethane	ND		ug/kg dry	110	570	100	EPA SW846-8260B	02/03/2012 16:33	02/03/2012 23:42	SS
75-01-4	Vinyl Chloride	ND		ug/kg dry	120	570	100	EPA SW846-8260B	02/03/2012 16:33	02/03/2012 23:42	SS
1330-20-7	Xylenes, Total	200	J	ug/kg dry	130	1700	100	EPA SW846-8260B	02/03/2012 16:33	02/03/2012 23:42	SS

Semi-Volatiles, 8270 Target List

Log-in Notes:

Sample Notes:

Sample Prepared by Method: EPA 3550B

CAS No.	Parameter	Result	Flag	Units	MDL	RL	Dilution	Reference Method	Date/Time Prepared	Date/Time Analyzed	Analyst
120-82-1	1,2,4-Trichlorobenzene	ND		ug/kg dry	104	191	1	EPA SW-846 8270C	02/03/2012 08:34	02/04/2012 01:36	TD
95-50-1	1,2-Dichlorobenzene	ND		ug/kg dry	83.4	191	1	EPA SW-846 8270C	02/03/2012 08:34	02/04/2012 01:36	TD
541-73-1	1,3-Dichlorobenzene	ND		ug/kg dry	90.8	191	1	EPA SW-846 8270C	02/03/2012 08:34	02/04/2012 01:36	TD
106-46-7	1,4-Dichlorobenzene	ND		ug/kg dry	65.4	191	1	EPA SW-846 8270C	02/03/2012 08:34	02/04/2012 01:36	TD
95-95-4	2,4,5-Trichlorophenol	ND		ug/kg dry	51.9	191	1	EPA SW-846 8270C	02/03/2012 08:34	02/04/2012 01:36	TD
88-06-2	2,4,6-Trichlorophenol	ND		ug/kg dry	93.3	191	1	EPA SW-846 8270C	02/03/2012 08:34	02/04/2012 01:36	TD
120-83-2	2,4-Dichlorophenol	ND		ug/kg dry	77.9	191	1	EPA SW-846 8270C	02/03/2012 08:34	02/04/2012 01:36	TD
105-67-9	2,4-Dimethylphenol	ND		ug/kg dry	61.2	191	1	EPA SW-846 8270C	02/03/2012 08:34	02/04/2012 01:36	TD
78-5	2,4-Dinitrophenol	ND		ug/kg dry	160	381	1	EPA SW-846 8270C	02/03/2012 08:34	02/04/2012 01:36	TD
14-2	2,4-Dinitrotoluene	ND		ug/kg dry	83.4	191	1	EPA SW-846 8270C	02/03/2012 08:34	02/04/2012 01:36	TD
606-20-2	2,6-Dinitrotoluene	ND		ug/kg dry	90.8	191	1	EPA SW-846 8270C	02/03/2012 08:34	02/04/2012 01:36	TD
91-58-7	2-Chloronaphthalene	ND		ug/kg dry	58.2	191	1	EPA SW-846 8270C	02/03/2012 08:34	02/04/2012 01:36	TD

YORK

ANALYTICAL LABORATORIES, INC.

Sample Information

Client Sample ID: 515W18-SB-4-7'-8'-Grab

York Sample ID: 12A0987-04

York Project (SDG) No.
12A0987

Client Project ID
515 West 18th St.

Matrix
Soil

Collection Date/Time
January 27, 2012 3:00 pm

Date Received
01/30/2012

Semi-Volatiles, 8270 Target List

Log-in Notes:

Sample Notes:

Sample Prepared by Method: EPA 3550B

CAS No.	Parameter	Result	Flag	Units	MDL	RL	Dilution	Reference Method	Date/Time Prepared	Date/Time Analyzed	Analyst
95-57-8	2-Chlorophenol	ND		ug/kg dry	111	191	1	EPA SW-846 8270C	02/03/2012 08:34	02/04/2012 01:36	TD
91-57-6	2-Methylnaphthalene	ND		ug/kg dry	66.4	191	1	EPA SW-846 8270C	02/03/2012 08:34	02/04/2012 01:36	TD
95-48-7	2-Methylphenol	ND		ug/kg dry	70.1	191	1	EPA SW-846 8270C	02/03/2012 08:34	02/04/2012 01:36	TD
88-75-5	2-Nitrophenol	ND		ug/kg dry	65.4	191	1	EPA SW-846 8270C	02/03/2012 08:34	02/04/2012 01:36	TD
100-01-6	3- & 4-Methylphenols	ND		ug/kg dry	85.8	191	1	EPA SW-846 8270C	02/03/2012 08:34	02/04/2012 01:36	TD
91-94-1	3,3'-Dichlorobenzidine	ND		ug/kg dry	48.0	191	1	EPA SW-846 8270C	02/03/2012 08:34	02/04/2012 01:36	TD
99-09-2	3-Nitroaniline	ND		ug/kg dry	69.1	191	1	EPA SW-846 8270C	02/03/2012 08:34	02/04/2012 01:36	TD
534-52-1	4,6-Dinitro-2-methylphenol	ND		ug/kg dry	144	381	1	EPA SW-846 8270C	02/03/2012 08:34	02/04/2012 01:36	TD
101-55-3	4-Bromophenyl phenyl ether	ND		ug/kg dry	79.5	191	1	EPA SW-846 8270C	02/03/2012 08:34	02/04/2012 01:36	TD
59-50-7	4-Chloro-3-methylphenol	ND		ug/kg dry	20.5	191	1	EPA SW-846 8270C	02/03/2012 08:34	02/04/2012 01:36	TD
106-47-8	4-Chloroaniline	ND		ug/kg dry	75.3	191	1	EPA SW-846 8270C	02/03/2012 08:34	02/04/2012 01:36	TD
7005-72-3	4-Chlorophenyl phenyl ether	ND		ug/kg dry	55.0	191	1	EPA SW-846 8270C	02/03/2012 08:34	02/04/2012 01:36	TD
102-7	4-Nitroaniline	ND		ug/kg dry	63.3	191	1	EPA SW-846 8270C	02/03/2012 08:34	02/04/2012 01:36	TD
56-57-5	4-Nitrophenol	ND		ug/kg dry	69.0	191	1	EPA SW-846 8270C	02/03/2012 08:34	02/04/2012 01:36	TD
83-32-9	Acenaphthene	ND		ug/kg dry	110	191	1	EPA SW-846 8270C	02/03/2012 08:34	02/04/2012 01:36	TD
208-96-8	Acenaphthylene	ND		ug/kg dry	53.4	191	1	EPA SW-846 8270C	02/03/2012 08:34	02/04/2012 01:36	TD
62-53-3	Aniline	ND		ug/kg dry	68.6	191	1	EPA SW-846 8270C	02/03/2012 08:34	02/04/2012 01:36	TD
120-12-7	Anthracene	ND		ug/kg dry	47.3	191	1	EPA SW-846 8270C	02/03/2012 08:34	02/04/2012 01:36	TD
56-55-3	Benzo(a)anthracene	82.4	J	ug/kg dry	73.8	191	1	EPA SW-846 8270C	02/03/2012 08:34	02/04/2012 01:36	TD
50-32-8	Benzo(a)pyrene	113	J	ug/kg dry	49.7	191	1	EPA SW-846 8270C	02/03/2012 08:34	02/04/2012 01:36	TD
205-99-2	Benzo(b)fluoranthene	85.4	J	ug/kg dry	72.6	191	1	EPA SW-846 8270C	02/03/2012 08:34	02/04/2012 01:36	TD
191-24-2	Benzo(g,h,i)perylene	62.9	J	ug/kg dry	57.3	191	1	EPA SW-846 8270C	02/03/2012 08:34	02/04/2012 01:36	TD
207-08-9	Benzo(k)fluoranthene	95.7	J	ug/kg dry	73.8	191	1	EPA SW-846 8270C	02/03/2012 08:34	02/04/2012 01:36	TD
100-51-6	Benzyl alcohol	ND		ug/kg dry	61.7	191	1	EPA SW-846 8270C	02/03/2012 08:34	02/04/2012 01:36	TD
85-68-7	Benzyl butyl phthalate	ND		ug/kg dry	79.5	191	1	EPA SW-846 8270C	02/03/2012 08:34	02/04/2012 01:36	TD
111-91-1	Bis(2-chloroethoxy)methane	ND		ug/kg dry	70.3	191	1	EPA SW-846 8270C	02/03/2012 08:34	02/04/2012 01:36	TD
111-44-4	Bis(2-chloroethyl)ether	ND		ug/kg dry	64.7	191	1	EPA SW-846 8270C	02/03/2012 08:34	02/04/2012 01:36	TD
108-60-1	Bis(2-chloroisopropyl)ether	ND		ug/kg dry	70.8	191	1	EPA SW-846 8270C	02/03/2012 08:34	02/04/2012 01:36	TD
117-81-7	Bis(2-ethylhexyl)phthalate	896		ug/kg dry	63.8	191	1	EPA SW-846 8270C	02/03/2012 08:34	02/04/2012 01:36	TD
218-01-9	Chrysene	90.7	J	ug/kg dry	76.8	191	1	EPA SW-846 8270C	02/03/2012 08:34	02/04/2012 01:36	TD
53-70-3	Dibenzo(a,h)anthracene	ND		ug/kg dry	48.2	191	1	EPA SW-846 8270C	02/03/2012 08:34	02/04/2012 01:36	TD
132-64-9	Dibenzofuran	ND		ug/kg dry	61.5	191	1	EPA SW-846 8270C	02/03/2012 08:34	02/04/2012 01:36	TD
5-2	Diethyl phthalate	ND		ug/kg dry	100	191	1	EPA SW-846 8270C	02/03/2012 08:34	02/04/2012 01:36	TD
131-11-3	Dimethyl phthalate	ND		ug/kg dry	55.0	191	1	EPA SW-846 8270C	02/03/2012 08:34	02/04/2012 01:36	TD
84-74-2	Di-n-butyl phthalate	ND		ug/kg dry	57.0	191	1	EPA SW-846 8270C	02/03/2012 08:34	02/04/2012 01:36	TD

YORK

ANALYTICAL LABORATORIES, INC.

Sample Information

Client Sample ID: 515W18-SB-4-7'-8'-Grab

York Sample ID: 12A0987-04

York Project (SDG) No.
12A0987

Client Project ID
515 West 18th St.

Matrix
Soil

Collection Date/Time
January 27, 2012 3:00 pm

Date Received
01/30/2012

Semi-Volatiles, 8270 Target List

Log-in Notes:

Sample Notes:

Sample Prepared by Method: EPA 3550B

CAS No.	Parameter	Result	Flag	Units	MDL	RL	Dilution	Reference Method	Date/Time Prepared	Date/Time Analyzed	Analyst
117-84-0	Di-n-octyl phthalate	ND		ug/kg dry	85.8	191	1	EPA SW-846 8270C	02/03/2012 08:34	02/04/2012 01:36	TD
206-44-0	Fluoranthene	ND		ug/kg dry	110	191	1	EPA SW-846 8270C	02/03/2012 08:34	02/04/2012 01:36	TD
86-73-7	Fluorene	ND		ug/kg dry	53.4	191	1	EPA SW-846 8270C	02/03/2012 08:34	02/04/2012 01:36	TD
118-74-1	Hexachlorobenzene	ND		ug/kg dry	31.1	191	1	EPA SW-846 8270C	02/03/2012 08:34	02/04/2012 01:36	TD
87-68-3	Hexachlorobutadiene	ND		ug/kg dry	76.3	191	1	EPA SW-846 8270C	02/03/2012 08:34	02/04/2012 01:36	TD
77-47-4	Hexachlorocyclopentadiene	ND		ug/kg dry	142	191	1	EPA SW-846 8270C	02/03/2012 08:34	02/04/2012 01:36	TD
67-72-1	Hexachloroethane	ND		ug/kg dry	68.6	191	1	EPA SW-846 8270C	02/03/2012 08:34	02/04/2012 01:36	TD
193-39-5	Indeno(1,2,3-cd)pyrene	ND		ug/kg dry	70.3	191	1	EPA SW-846 8270C	02/03/2012 08:34	02/04/2012 01:36	TD
78-59-1	Isophorone	ND		ug/kg dry	70.8	191	1	EPA SW-846 8270C	02/03/2012 08:34	02/04/2012 01:36	TD
91-20-3	Naphthalene	ND		ug/kg dry	57.0	191	1	EPA SW-846 8270C	02/03/2012 08:34	02/04/2012 01:36	TD
98-95-3	Nitrobenzene	ND		ug/kg dry	85.8	191	1	EPA SW-846 8270C	02/03/2012 08:34	02/04/2012 01:36	TD
62-75-9	N-Nitrosodimethylamine	ND		ug/kg dry	69.0	191	1	EPA SW-846 8270C	02/03/2012 08:34	02/04/2012 01:36	TD
4-7	N-nitroso-di-n-propylamine	ND		ug/kg dry	49.8	191	1	EPA SW-846 8270C	02/03/2012 08:34	02/04/2012 01:36	TD
80-10-6	N-Nitrosodiphenylamine	ND		ug/kg dry	110	191	1	EPA SW-846 8270C	02/03/2012 08:34	02/04/2012 01:36	TD
87-86-5	Pentachlorophenol	ND		ug/kg dry	53.4	191	1	EPA SW-846 8270C	02/03/2012 08:34	02/04/2012 01:36	TD
85-01-8	Phenanthrene	ND		ug/kg dry	70.3	191	1	EPA SW-846 8270C	02/03/2012 08:34	02/04/2012 01:36	TD
108-95-2	Phenol	ND		ug/kg dry	76.3	191	1	EPA SW-846 8270C	02/03/2012 08:34	02/04/2012 01:36	TD
129-00-0	Pyrene	114	J	ug/kg dry	68.4	191	1	EPA SW-846 8270C	02/03/2012 08:34	02/04/2012 01:36	TD
110-86-1	Pyridine	ND		ug/kg dry	74.5	191	1	EPA SW-846 8270C	02/03/2012 08:34	02/04/2012 01:36	TD

Total Solids

Log-in Notes:

Sample Notes:

Sample Prepared by Method: % Solids Prep

CAS No.	Parameter	Result	Flag	Units	MDL	RL	Dilution	Reference Method	Date/Time Prepared	Date/Time Analyzed	Analyst
solids	% Solids	87.4		%	0.100	0.100	1	SM 2540G	02/03/2012 14:33	02/03/2012 14:33	JCC

Sample Information

Client Sample ID: 515W18-SB-5-9'-9.5'-Grab

York Sample ID: 12A0987-05

York Project (SDG) No.
12A0987

Client Project ID
515 West 18th St.

Matrix
Soil

Collection Date/Time
January 26, 2012 3:00 pm

Date Received
01/30/2012

Volatile Organics, 8260 List

Log-in Notes:

Sample Notes:

Sample Prepared by Method: EPA 5035B

CAS No.	Parameter	Result	Flag	Units	MDL	RL	Dilution	Reference Method	Date/Time Prepared	Date/Time Analyzed	Analyst
106-10-6	1,1,1,2-Tetrachloroethane	ND		ug/kg dry	340	2900	500	EPA SW846-8260B	02/03/2012 16:33	02/04/2012 00:18	SS
71-55-6	1,1,1-Trichloroethane	ND		ug/kg dry	600	2900	500	EPA SW846-8260B	02/03/2012 16:33	02/04/2012 00:18	SS
79-34-5	1,1,2,2-Tetrachloroethane	ND		ug/kg dry	360	2900	500	EPA SW846-8260B	02/03/2012 16:33	02/04/2012 00:18	SS

YORK

ANALYTICAL LABORATORIES, INC.

Sample Information

Client Sample ID: 515W18-SB-5-9'-9.5'-Grab

York Sample ID: 12A0987-05

York Project (SDG) No.
12A0987

Client Project ID
515 West 18th St.

Matrix
Soil

Collection Date/Time
January 26, 2012 3:00 pm

Date Received
01/30/2012

Volatiles Organics, 8260 List

Log-in Notes:

Sample Notes:

Sample Prepared by Method: EPA 5035B

CAS No.	Parameter	Result	Flag	Units	MDL	RL	Dilution	Reference Method	Date/Time Prepared	Date/Time Analyzed	Analyst
76-13-1	1,1,2-Trichloro-1,2,2-trifluoroethane (Freon 113)	ND		ug/kg dry	380	2900	500	EPA SW846-8260B	02/03/2012 16:33	02/04/2012 00:18	SS
79-00-5	1,1,2-Trichloroethane	ND		ug/kg dry	380	2900	500	EPA SW846-8260B	02/03/2012 16:33	02/04/2012 00:18	SS
75-34-3	1,1-Dichloroethane	ND		ug/kg dry	430	2900	500	EPA SW846-8260B	02/03/2012 16:33	02/04/2012 00:18	SS
75-35-4	1,1-Dichloroethylene	ND		ug/kg dry	840	2900	500	EPA SW846-8260B	02/03/2012 16:33	02/04/2012 00:18	SS
563-58-6	1,1-Dichloropropylene	ND		ug/kg dry	270	2900	500	EPA SW846-8260B	02/03/2012 16:33	02/04/2012 00:18	SS
87-61-6	1,2,3-Trichlorobenzene	ND		ug/kg dry	230	5800	500	EPA SW846-8260B	02/03/2012 16:33	02/04/2012 00:18	SS
96-18-4	1,2,3-Trichloropropane	ND		ug/kg dry	720	2900	500	EPA SW846-8260B	02/03/2012 16:33	02/04/2012 00:18	SS
120-82-1	1,2,4-Trichlorobenzene	ND		ug/kg dry	300	5800	500	EPA SW846-8260B	02/03/2012 16:33	02/04/2012 00:18	SS
95-63-6	1,2,4-Trimethylbenzene	ND		ug/kg dry	330	2900	500	EPA SW846-8260B	02/03/2012 16:33	02/04/2012 00:18	SS
96-12-8	1,2-Dibromo-3-chloropropane	ND		ug/kg dry	830	5800	500	EPA SW846-8260B	02/03/2012 16:33	02/04/2012 00:18	SS
106-93-4	1,2-Dibromoethane	ND		ug/kg dry	430	2900	500	EPA SW846-8260B	02/03/2012 16:33	02/04/2012 00:18	SS
95-50-1	1,2-Dichlorobenzene	ND		ug/kg dry	370	2900	500	EPA SW846-8260B	02/03/2012 16:33	02/04/2012 00:18	SS
76-2	1,2-Dichloroethane	ND		ug/kg dry	410	2900	500	EPA SW846-8260B	02/03/2012 16:33	02/04/2012 00:18	SS
78-87-5	1,2-Dichloropropane	ND		ug/kg dry	140	2900	500	EPA SW846-8260B	02/03/2012 16:33	02/04/2012 00:18	SS
108-67-8	1,3,5-Trimethylbenzene	ND		ug/kg dry	230	2900	500	EPA SW846-8260B	02/03/2012 16:33	02/04/2012 00:18	SS
541-73-1	1,3-Dichlorobenzene	ND		ug/kg dry	300	2900	500	EPA SW846-8260B	02/03/2012 16:33	02/04/2012 00:18	SS
142-28-9	1,3-Dichloropropane	ND		ug/kg dry	430	2900	500	EPA SW846-8260B	02/03/2012 16:33	02/04/2012 00:18	SS
106-46-7	1,4-Dichlorobenzene	ND		ug/kg dry	430	2900	500	EPA SW846-8260B	02/03/2012 16:33	02/04/2012 00:18	SS
594-20-7	2,2-Dichloropropane	ND		ug/kg dry	600	2900	500	EPA SW846-8260B	02/03/2012 16:33	02/04/2012 00:18	SS
78-93-3	2-Butanone	ND		ug/kg dry	1600	5800	500	EPA SW846-8260B	02/03/2012 16:33	02/04/2012 00:18	SS
95-49-8	2-Chlorotoluene	ND		ug/kg dry	310	2900	500	EPA SW846-8260B	02/03/2012 16:33	02/04/2012 00:18	SS
106-43-4	4-Chlorotoluene	ND		ug/kg dry	310	2900	500	EPA SW846-8260B	02/03/2012 16:33	02/04/2012 00:18	SS
67-64-1	Acetone	4200	J	ug/kg dry	2000	5800	500	EPA SW846-8260B	02/03/2012 16:33	02/04/2012 00:18	SS
71-43-2	Benzene	ND		ug/kg dry	300	2900	500	EPA SW846-8260B	02/03/2012 16:33	02/04/2012 00:18	SS
108-86-1	Bromobenzene	ND		ug/kg dry	380	2900	500	EPA SW846-8260B	02/03/2012 16:33	02/04/2012 00:18	SS
74-97-5	Bromochloromethane	ND		ug/kg dry	810	2900	500	EPA SW846-8260B	02/03/2012 16:33	02/04/2012 00:18	SS
75-27-4	Bromodichloromethane	ND		ug/kg dry	390	2900	500	EPA SW846-8260B	02/03/2012 16:33	02/04/2012 00:18	SS
75-25-2	Bromoform	ND		ug/kg dry	370	2900	500	EPA SW846-8260B	02/03/2012 16:33	02/04/2012 00:18	SS
74-83-9	Bromomethane	ND		ug/kg dry	780	2900	500	EPA SW846-8260B	02/03/2012 16:33	02/04/2012 00:18	SS
56-23-5	Carbon tetrachloride	ND		ug/kg dry	650	2900	500	EPA SW846-8260B	02/03/2012 16:33	02/04/2012 00:18	SS
108-90-7	Chlorobenzene	ND		ug/kg dry	220	2900	500	EPA SW846-8260B	02/03/2012 16:33	02/04/2012 00:18	SS
75-35-2	Chloroethane	ND		ug/kg dry	480	2900	500	EPA SW846-8260B	02/03/2012 16:33	02/04/2012 00:18	SS
67-66-3	Chloroform	ND		ug/kg dry	230	2900	500	EPA SW846-8260B	02/03/2012 16:33	02/04/2012 00:18	SS
74-87-3	Chloromethane	ND		ug/kg dry	560	2900	500	EPA SW846-8260B	02/03/2012 16:33	02/04/2012 00:18	SS

YORK

ANALYTICAL LABORATORIES, INC.

Sample Information

Client Sample ID: 515W18-SB-5-9'-9.5'-Grab

York Sample ID: 12A0987-05

York Project (SDG) No.
12A0987

Client Project ID
515 West 18th St.

Matrix
Soil

Collection Date/Time
January 26, 2012 3:00 pm

Date Received
01/30/2012

Volatile Organics, 8260 List

Log-in Notes:

Sample Notes:

Sample Prepared by Method: EPA 5035B

CAS No.	Parameter	Result	Flag	Units	MDL	RL	Dilution	Reference Method	Date/Time Prepared	Date/Time Analyzed	Analyst
156-59-2	cis-1,2-Dichloroethylene	ND		ug/kg dry	600	2900	500	EPA SW846-8260B	02/03/2012 16:33	02/04/2012 00:18	SS
10061-01-5	cis-1,3-Dichloropropylene	ND		ug/kg dry	220	2900	500	EPA SW846-8260B	02/03/2012 16:33	02/04/2012 00:18	SS
124-48-1	Dibromochloromethane	ND		ug/kg dry	420	2900	500	EPA SW846-8260B	02/03/2012 16:33	02/04/2012 00:18	SS
74-95-3	Dibromomethane	ND		ug/kg dry	840	2900	500	EPA SW846-8260B	02/03/2012 16:33	02/04/2012 00:18	SS
75-71-8	Dichlorodifluoromethane	ND		ug/kg dry	520	2900	500	EPA SW846-8260B	02/03/2012 16:33	02/04/2012 00:18	SS
100-41-4	Ethyl Benzene	ND		ug/kg dry	220	2900	500	EPA SW846-8260B	02/03/2012 16:33	02/04/2012 00:18	SS
87-68-3	Hexachlorobutadiene	ND		ug/kg dry	270	2900	500	EPA SW846-8260B	02/03/2012 16:33	02/04/2012 00:18	SS
98-82-8	Isopropylbenzene	4900		ug/kg dry	250	2900	500	EPA SW846-8260B	02/03/2012 16:33	02/04/2012 00:18	SS
1634-04-4	Methyl tert-butyl ether (MTBE)	ND		ug/kg dry	240	2900	500	EPA SW846-8260B	02/03/2012 16:33	02/04/2012 00:18	SS
75-09-2	Methylene chloride	3000	J, B	ug/kg dry	670	5800	500	EPA SW846-8260B	02/03/2012 16:33	02/04/2012 00:18	SS
91-20-3	Naphthalene	ND		ug/kg dry	310	5800	500	EPA SW846-8260B	02/03/2012 16:33	02/04/2012 00:18	SS
104-51-8	n-Butylbenzene	3900		ug/kg dry	200	2900	500	EPA SW846-8260B	02/03/2012 16:33	02/04/2012 00:18	SS
100-65-1	n-Propylbenzene	7100		ug/kg dry	370	2900	500	EPA SW846-8260B	02/03/2012 16:33	02/04/2012 00:18	SS
100-67-6	o-Xylene	ND		ug/kg dry	310	2900	500	EPA SW846-8260B	02/03/2012 16:33	02/04/2012 00:18	SS
1330-20-7P/M	p- & m- Xylenes	ND		ug/kg dry	350	5800	500	EPA SW846-8260B	02/03/2012 16:33	02/04/2012 00:18	SS
99-87-6	p-Isopropyltoluene	ND		ug/kg dry	160	2900	500	EPA SW846-8260B	02/03/2012 16:33	02/04/2012 00:18	SS
135-98-8	sec-Butylbenzene	3000		ug/kg dry	330	2900	500	EPA SW846-8260B	02/03/2012 16:33	02/04/2012 00:18	SS
100-42-5	Styrene	ND		ug/kg dry	270	2900	500	EPA SW846-8260B	02/03/2012 16:33	02/04/2012 00:18	SS
98-06-6	tert-Butylbenzene	ND		ug/kg dry	290	2900	500	EPA SW846-8260B	02/03/2012 16:33	02/04/2012 00:18	SS
127-18-4	Tetrachloroethylene	ND		ug/kg dry	330	2900	500	EPA SW846-8260B	02/03/2012 16:33	02/04/2012 00:18	SS
108-88-3	Toluene	ND		ug/kg dry	140	2900	500	EPA SW846-8260B	02/03/2012 16:33	02/04/2012 00:18	SS
156-60-5	trans-1,2-Dichloroethylene	ND		ug/kg dry	410	2900	500	EPA SW846-8260B	02/03/2012 16:33	02/04/2012 00:18	SS
10061-02-6	trans-1,3-Dichloropropylene	ND		ug/kg dry	430	2900	500	EPA SW846-8260B	02/03/2012 16:33	02/04/2012 00:18	SS
79-01-6	Trichloroethylene	ND		ug/kg dry	360	2900	500	EPA SW846-8260B	02/03/2012 16:33	02/04/2012 00:18	SS
75-69-4	Trichlorofluoromethane	ND		ug/kg dry	570	2900	500	EPA SW846-8260B	02/03/2012 16:33	02/04/2012 00:18	SS
75-01-4	Vinyl Chloride	ND		ug/kg dry	610	2900	500	EPA SW846-8260B	02/03/2012 16:33	02/04/2012 00:18	SS
1330-20-7	Xylenes, Total	ND		ug/kg dry	660	8700	500	EPA SW846-8260B	02/03/2012 16:33	02/04/2012 00:18	SS

YORK

ANALYTICAL LABORATORIES, INC.

Sample Information

Client Sample ID: 515W18-SB-5-9'-9.5'-Grab

York Sample ID: 12A0987-05

York Project (SDG) No.
12A0987

Client Project ID
515 West 18th St.

Matrix
Soil

Collection Date/Time
January 26, 2012 3:00 pm

Date Received
01/30/2012

Semi-Volatiles, 8270 Target List

Log-in Notes:

Sample Notes:

Sample Prepared by Method: EPA 3550B

CAS No.	Parameter	Result	Flag	Units	MDL	RL	Dilution	Reference Method	Date/Time Prepared	Date/Time Analyzed	Analyst
120-82-1	1,2,4-Trichlorobenzene	ND		ug/kg dry	106	194	1	EPA SW-846 8270C	02/03/2012 08:34	02/04/2012 02:09	TD
95-50-1	1,2-Dichlorobenzene	ND		ug/kg dry	85.0	194	1	EPA SW-846 8270C	02/03/2012 08:34	02/04/2012 02:09	TD
541-73-1	1,3-Dichlorobenzene	ND		ug/kg dry	92.5	194	1	EPA SW-846 8270C	02/03/2012 08:34	02/04/2012 02:09	TD
106-46-7	1,4-Dichlorobenzene	ND		ug/kg dry	66.6	194	1	EPA SW-846 8270C	02/03/2012 08:34	02/04/2012 02:09	TD
95-95-4	2,4,5-Trichlorophenol	ND		ug/kg dry	52.8	194	1	EPA SW-846 8270C	02/03/2012 08:34	02/04/2012 02:09	TD
88-06-2	2,4,6-Trichlorophenol	ND		ug/kg dry	95.0	194	1	EPA SW-846 8270C	02/03/2012 08:34	02/04/2012 02:09	TD
120-83-2	2,4-Dichlorophenol	ND		ug/kg dry	79.4	194	1	EPA SW-846 8270C	02/03/2012 08:34	02/04/2012 02:09	TD
105-67-9	2,4-Dimethylphenol	ND		ug/kg dry	62.3	194	1	EPA SW-846 8270C	02/03/2012 08:34	02/04/2012 02:09	TD
51-28-5	2,4-Dinitrophenol	ND		ug/kg dry	163	389	1	EPA SW-846 8270C	02/03/2012 08:34	02/04/2012 02:09	TD
121-14-2	2,4-Dinitrotoluene	ND		ug/kg dry	85.0	194	1	EPA SW-846 8270C	02/03/2012 08:34	02/04/2012 02:09	TD
606-20-2	2,6-Dinitrotoluene	ND		ug/kg dry	92.5	194	1	EPA SW-846 8270C	02/03/2012 08:34	02/04/2012 02:09	TD
91-58-7	2-Chloronaphthalene	ND		ug/kg dry	59.3	194	1	EPA SW-846 8270C	02/03/2012 08:34	02/04/2012 02:09	TD
7-8	2-Chlorophenol	ND		ug/kg dry	113	194	1	EPA SW-846 8270C	02/03/2012 08:34	02/04/2012 02:09	TD
91-57-6	2-Methylnaphthalene	3480		ug/kg dry	67.7	194	1	EPA SW-846 8270C	02/03/2012 08:34	02/04/2012 02:09	TD
95-48-7	2-Methylphenol	ND		ug/kg dry	71.5	194	1	EPA SW-846 8270C	02/03/2012 08:34	02/04/2012 02:09	TD
88-75-5	2-Nitrophenol	ND		ug/kg dry	66.6	194	1	EPA SW-846 8270C	02/03/2012 08:34	02/04/2012 02:09	TD
100-01-6	3- & 4-Methylphenols	ND		ug/kg dry	87.4	194	1	EPA SW-846 8270C	02/03/2012 08:34	02/04/2012 02:09	TD
91-94-1	3,3'-Dichlorobenzidine	ND		ug/kg dry	48.9	194	1	EPA SW-846 8270C	02/03/2012 08:34	02/04/2012 02:09	TD
99-09-2	3-Nitroaniline	ND		ug/kg dry	70.4	194	1	EPA SW-846 8270C	02/03/2012 08:34	02/04/2012 02:09	TD
534-52-1	4,6-Dinitro-2-methylphenol	ND		ug/kg dry	147	389	1	EPA SW-846 8270C	02/03/2012 08:34	02/04/2012 02:09	TD
101-55-3	4-Bromophenyl phenyl ether	ND		ug/kg dry	81.0	194	1	EPA SW-846 8270C	02/03/2012 08:34	02/04/2012 02:09	TD
59-50-7	4-Chloro-3-methylphenol	ND		ug/kg dry	20.9	194	1	EPA SW-846 8270C	02/03/2012 08:34	02/04/2012 02:09	TD
106-47-8	4-Chloroaniline	ND		ug/kg dry	76.7	194	1	EPA SW-846 8270C	02/03/2012 08:34	02/04/2012 02:09	TD
7005-72-3	4-Chlorophenyl phenyl ether	ND		ug/kg dry	56.0	194	1	EPA SW-846 8270C	02/03/2012 08:34	02/04/2012 02:09	TD
100-02-7	4-Nitroaniline	ND		ug/kg dry	64.5	194	1	EPA SW-846 8270C	02/03/2012 08:34	02/04/2012 02:09	TD
56-57-5	4-Nitrophenol	ND		ug/kg dry	70.3	194	1	EPA SW-846 8270C	02/03/2012 08:34	02/04/2012 02:09	TD
83-32-9	Acenaphthene	439		ug/kg dry	113	194	1	EPA SW-846 8270C	02/03/2012 08:34	02/04/2012 02:09	TD
208-96-8	Acenaphthylene	ND		ug/kg dry	54.4	194	1	EPA SW-846 8270C	02/03/2012 08:34	02/04/2012 02:09	TD
62-53-3	Aniline	ND		ug/kg dry	69.9	194	1	EPA SW-846 8270C	02/03/2012 08:34	02/04/2012 02:09	TD
120-12-7	Anthracene	233		ug/kg dry	48.2	194	1	EPA SW-846 8270C	02/03/2012 08:34	02/04/2012 02:09	TD
56-55-3	Benzo(a)anthracene	172	J	ug/kg dry	75.2	194	1	EPA SW-846 8270C	02/03/2012 08:34	02/04/2012 02:09	TD
50-32-8	Benzo(a)pyrene	138	J	ug/kg dry	50.7	194	1	EPA SW-846 8270C	02/03/2012 08:34	02/04/2012 02:09	TD
39-2	Benzo(b)fluoranthene	137	J	ug/kg dry	73.9	194	1	EPA SW-846 8270C	02/03/2012 08:34	02/04/2012 02:09	TD
191-24-2	Benzo(g,h,i)perylene	ND		ug/kg dry	58.4	194	1	EPA SW-846 8270C	02/03/2012 08:34	02/04/2012 02:09	TD
207-08-9	Benzo(k)fluoranthene	114	J	ug/kg dry	75.2	194	1	EPA SW-846 8270C	02/03/2012 08:34	02/04/2012 02:09	TD

YORK

ANALYTICAL LABORATORIES, INC.

Sample Information

Client Sample ID: 515W18-SB-5-9'-9.5'-Grab

York Sample ID: 12A0987-05

York Project (SDG) No.
12A0987

Client Project ID
515 West 18th St.

Matrix
Soil

Collection Date/Time
January 26, 2012 3:00 pm

Date Received
01/30/2012

Semi-Volatiles, 8270 Target List

Log-in Notes:

Sample Notes:

Sample Prepared by Method: EPA 3550B

CAS No.	Parameter	Result	Flag	Units	MDL	RL	Dilution	Reference Method	Date/Time Prepared	Date/Time Analyzed	Analyst
100-51-6	Benzyl alcohol	ND		ug/kg dry	62.9	194	1	EPA SW-846 8270C	02/03/2012 08:34	02/04/2012 02:09	TD
85-68-7	Benzyl butyl phthalate	ND		ug/kg dry	81.0	194	1	EPA SW-846 8270C	02/03/2012 08:34	02/04/2012 02:09	TD
111-91-1	Bis(2-chloroethoxy)methane	ND		ug/kg dry	71.6	194	1	EPA SW-846 8270C	02/03/2012 08:34	02/04/2012 02:09	TD
111-44-4	Bis(2-chloroethyl)ether	ND		ug/kg dry	66.0	194	1	EPA SW-846 8270C	02/03/2012 08:34	02/04/2012 02:09	TD
108-60-1	Bis(2-chloroisopropyl)ether	ND		ug/kg dry	72.2	194	1	EPA SW-846 8270C	02/03/2012 08:34	02/04/2012 02:09	TD
117-81-7	Bis(2-ethylhexyl)phthalate	95.2	J	ug/kg dry	65.1	194	1	EPA SW-846 8270C	02/03/2012 08:34	02/04/2012 02:09	TD
218-01-9	Chrysene	277		ug/kg dry	78.3	194	1	EPA SW-846 8270C	02/03/2012 08:34	02/04/2012 02:09	TD
53-70-3	Dibenzo(a,h)anthracene	ND		ug/kg dry	49.1	194	1	EPA SW-846 8270C	02/03/2012 08:34	02/04/2012 02:09	TD
132-64-9	Dibenzofuran	ND		ug/kg dry	62.7	194	1	EPA SW-846 8270C	02/03/2012 08:34	02/04/2012 02:09	TD
84-66-2	Diethyl phthalate	ND		ug/kg dry	102	194	1	EPA SW-846 8270C	02/03/2012 08:34	02/04/2012 02:09	TD
131-11-3	Dimethyl phthalate	ND		ug/kg dry	56.0	194	1	EPA SW-846 8270C	02/03/2012 08:34	02/04/2012 02:09	TD
84-74-2	Di-n-butyl phthalate	ND		ug/kg dry	58.0	194	1	EPA SW-846 8270C	02/03/2012 08:34	02/04/2012 02:09	TD
117-84-0	Di-n-octyl phthalate	ND		ug/kg dry	87.4	194	1	EPA SW-846 8270C	02/03/2012 08:34	02/04/2012 02:09	TD
149-44-0	Fluoranthene	672		ug/kg dry	113	194	1	EPA SW-846 8270C	02/03/2012 08:34	02/04/2012 02:09	TD
86-73-7	Fluorene	ND		ug/kg dry	54.4	194	1	EPA SW-846 8270C	02/03/2012 08:34	02/04/2012 02:09	TD
118-74-1	Hexachlorobenzene	ND		ug/kg dry	31.7	194	1	EPA SW-846 8270C	02/03/2012 08:34	02/04/2012 02:09	TD
87-68-3	Hexachlorobutadiene	ND		ug/kg dry	77.7	194	1	EPA SW-846 8270C	02/03/2012 08:34	02/04/2012 02:09	TD
77-47-4	Hexachlorocyclopentadiene	ND		ug/kg dry	145	194	1	EPA SW-846 8270C	02/03/2012 08:34	02/04/2012 02:09	TD
67-72-1	Hexachloroethane	ND		ug/kg dry	69.9	194	1	EPA SW-846 8270C	02/03/2012 08:34	02/04/2012 02:09	TD
193-39-5	Indeno(1,2,3-cd)pyrene	ND		ug/kg dry	71.6	194	1	EPA SW-846 8270C	02/03/2012 08:34	02/04/2012 02:09	TD
78-59-1	Isophorone	ND		ug/kg dry	72.2	194	1	EPA SW-846 8270C	02/03/2012 08:34	02/04/2012 02:09	TD
91-20-3	Naphthalene	ND		ug/kg dry	58.0	194	1	EPA SW-846 8270C	02/03/2012 08:34	02/04/2012 02:09	TD
98-95-3	Nitrobenzene	ND		ug/kg dry	87.4	194	1	EPA SW-846 8270C	02/03/2012 08:34	02/04/2012 02:09	TD
62-75-9	N-Nitrosodimethylamine	ND		ug/kg dry	70.3	194	1	EPA SW-846 8270C	02/03/2012 08:34	02/04/2012 02:09	TD
621-64-7	N-nitroso-di-n-propylamine	ND		ug/kg dry	50.7	194	1	EPA SW-846 8270C	02/03/2012 08:34	02/04/2012 02:09	TD
86-30-6	N-Nitrosodiphenylamine	ND		ug/kg dry	113	194	1	EPA SW-846 8270C	02/03/2012 08:34	02/04/2012 02:09	TD
87-86-5	Pentachlorophenol	ND		ug/kg dry	54.4	194	1	EPA SW-846 8270C	02/03/2012 08:34	02/04/2012 02:09	TD
85-01-8	Phenanthrene	1700		ug/kg dry	71.7	194	1	EPA SW-846 8270C	02/03/2012 08:34	02/04/2012 02:09	TD
108-95-2	Phenol	ND		ug/kg dry	77.7	194	1	EPA SW-846 8270C	02/03/2012 08:34	02/04/2012 02:09	TD
129-00-0	Pyrene	652		ug/kg dry	69.7	194	1	EPA SW-846 8270C	02/03/2012 08:34	02/04/2012 02:09	TD
110-86-1	Pyridine	ND		ug/kg dry	75.9	194	1	EPA SW-846 8270C	02/03/2012 08:34	02/04/2012 02:09	TD

YORK

ANALYTICAL LABORATORIES, INC.

Sample Information

Client Sample ID: 515W18-SB-5-9'-9.5'-Grab

York Sample ID: 12A0987-05

York Project (SDG) No.
12A0987

Client Project ID
515 West 18th St.

Matrix
Soil

Collection Date/Time
January 26, 2012 3:00 pm

Date Received
01/30/2012

Total Solids

Log-in Notes:

Sample Notes:

Sample Prepared by Method: % Solids Prep

CAS No.	Parameter	Result	Flag	Units	MDL	RL	Dilution	Reference Method	Date/Time Prepared	Date/Time Analyzed	Analyst
solids	% Solids	85.8		%	0.100	0.100	1	SM 2540G	02/03/2012 14:33	02/03/2012 14:33	JCC

Sample Information

Client Sample ID: 515W18-SB-6-10'-10.5'-Grab

York Sample ID: 12A0987-06

York Project (SDG) No.
12A0987

Client Project ID
515 West 18th St.

Matrix
Soil

Collection Date/Time
January 26, 2012 3:00 pm

Date Received
01/30/2012

Volatile Organics, 8260 List

Log-in Notes:

Sample Notes:

Sample Prepared by Method: EPA 5035B

CAS No.	Parameter	Result	Flag	Units	MDL	RL	Dilution	Reference Method	Date/Time Prepared	Date/Time Analyzed	Analyst
630-20-6	1,1,1,2-Tetrachloroethane	ND		ug/kg dry	7.3	62	10	EPA SW846-8260B	02/03/2012 16:33	02/06/2012 17:26	SS
71-55-6	1,1,1-Trichloroethane	ND		ug/kg dry	13	62	10	EPA SW846-8260B	02/03/2012 16:33	02/06/2012 17:26	SS
79-34-5	1,1,2,2-Tetrachloroethane	ND		ug/kg dry	7.7	62	10	EPA SW846-8260B	02/03/2012 16:33	02/06/2012 17:26	SS
3-1	1,1,2-Trichloro-1,2,2-trifluoroethane (Freon 113)	ND		ug/kg dry	8.1	62	10	EPA SW846-8260B	02/03/2012 16:33	02/06/2012 17:26	SS
79-00-5	1,1,2-Trichloroethane	ND		ug/kg dry	8.2	62	10	EPA SW846-8260B	02/03/2012 16:33	02/06/2012 17:26	SS
75-34-3	1,1-Dichloroethane	ND		ug/kg dry	9.3	62	10	EPA SW846-8260B	02/03/2012 16:33	02/06/2012 17:26	SS
75-35-4	1,1-Dichloroethylene	ND		ug/kg dry	18	62	10	EPA SW846-8260B	02/03/2012 16:33	02/06/2012 17:26	SS
563-58-6	1,1-Dichloropropylene	ND		ug/kg dry	5.8	62	10	EPA SW846-8260B	02/03/2012 16:33	02/06/2012 17:26	SS
87-61-6	1,2,3-Trichlorobenzene	ND		ug/kg dry	5.0	120	10	EPA SW846-8260B	02/03/2012 16:33	02/06/2012 17:26	SS
96-18-4	1,2,3-Trichloropropane	ND		ug/kg dry	15	62	10	EPA SW846-8260B	02/03/2012 16:33	02/06/2012 17:26	SS
120-82-1	1,2,4-Trichlorobenzene	ND		ug/kg dry	6.5	120	10	EPA SW846-8260B	02/03/2012 16:33	02/06/2012 17:26	SS
95-63-6	1,2,4-Trimethylbenzene	ND		ug/kg dry	7.1	62	10	EPA SW846-8260B	02/03/2012 16:33	02/06/2012 17:26	SS
96-12-8	1,2-Dibromo-3-chloropropane	ND		ug/kg dry	18	120	10	EPA SW846-8260B	02/03/2012 16:33	02/06/2012 17:26	SS
106-93-4	1,2-Dibromoethane	ND		ug/kg dry	9.2	62	10	EPA SW846-8260B	02/03/2012 16:33	02/06/2012 17:26	SS
95-50-1	1,2-Dichlorobenzene	ND		ug/kg dry	8.0	62	10	EPA SW846-8260B	02/03/2012 16:33	02/06/2012 17:26	SS
107-06-2	1,2-Dichloroethane	ND		ug/kg dry	8.8	62	10	EPA SW846-8260B	02/03/2012 16:33	02/06/2012 17:26	SS
78-87-5	1,2-Dichloropropane	ND		ug/kg dry	3.0	62	10	EPA SW846-8260B	02/03/2012 16:33	02/06/2012 17:26	SS
108-67-8	1,3,5-Trimethylbenzene	ND		ug/kg dry	5.0	62	10	EPA SW846-8260B	02/03/2012 16:33	02/06/2012 17:26	SS
541-73-1	1,3-Dichlorobenzene	ND		ug/kg dry	6.3	62	10	EPA SW846-8260B	02/03/2012 16:33	02/06/2012 17:26	SS
142-28-9	1,3-Dichloropropane	ND		ug/kg dry	9.3	62	10	EPA SW846-8260B	02/03/2012 16:33	02/06/2012 17:26	SS
106-46-7	1,4-Dichlorobenzene	ND		ug/kg dry	9.2	62	10	EPA SW846-8260B	02/03/2012 16:33	02/06/2012 17:26	SS
20-7	2,2-Dichloropropane	ND		ug/kg dry	13	62	10	EPA SW846-8260B	02/03/2012 16:33	02/06/2012 17:26	SS
78-93-3	2-Butanone	ND		ug/kg dry	35	120	10	EPA SW846-8260B	02/03/2012 16:33	02/06/2012 17:26	SS
95-49-8	2-Chlorotoluene	ND		ug/kg dry	6.6	62	10	EPA SW846-8260B	02/03/2012 16:33	02/06/2012 17:26	SS

YORK

ANALYTICAL LABORATORIES, INC.

Sample Information

Client Sample ID: 515W18-SB-6-10'-10.5'-Grab

York Sample ID: 12A0987-06

York Project (SDG) No.
12A0987

Client Project ID
515 West 18th St.

Matrix
Soil

Collection Date/Time
January 26, 2012 3:00 pm

Date Received
01/30/2012

Volatiles Organics, 8260 List

Log-in Notes:

Sample Notes:

Sample Prepared by Method: EPA 5035B

CAS No.	Parameter	Result	Flag	Units	MDL	RL	Dilution	Reference Method	Date/Time Prepared	Date/Time Analyzed	Analyst
106-43-4	4-Chlorotoluene	ND		ug/kg dry	6.6	62	10	EPA SW846-8260B	02/03/2012 16:33	02/06/2012 17:26	SS
67-64-1	Acetone	140		ug/kg dry	42	120	10	EPA SW846-8260B	02/03/2012 16:33	02/06/2012 17:26	SS
71-43-2	Benzene	26	J	ug/kg dry	6.5	62	10	EPA SW846-8260B	02/03/2012 16:33	02/06/2012 17:26	SS
108-86-1	Bromobenzene	ND		ug/kg dry	8.2	62	10	EPA SW846-8260B	02/03/2012 16:33	02/06/2012 17:26	SS
74-97-5	Bromochloromethane	ND		ug/kg dry	17	62	10	EPA SW846-8260B	02/03/2012 16:33	02/06/2012 17:26	SS
75-27-4	Bromodichloromethane	ND		ug/kg dry	8.4	62	10	EPA SW846-8260B	02/03/2012 16:33	02/06/2012 17:26	SS
75-25-2	Bromoform	ND		ug/kg dry	7.8	62	10	EPA SW846-8260B	02/03/2012 16:33	02/06/2012 17:26	SS
74-83-9	Bromomethane	ND		ug/kg dry	17	62	10	EPA SW846-8260B	02/03/2012 16:33	02/06/2012 17:26	SS
56-23-5	Carbon tetrachloride	ND		ug/kg dry	14	62	10	EPA SW846-8260B	02/03/2012 16:33	02/06/2012 17:26	SS
108-90-7	Chlorobenzene	ND		ug/kg dry	4.7	62	10	EPA SW846-8260B	02/03/2012 16:33	02/06/2012 17:26	SS
75-00-3	Chloroethane	ND		ug/kg dry	10	62	10	EPA SW846-8260B	02/03/2012 16:33	02/06/2012 17:26	SS
67-66-3	Chloroform	ND		ug/kg dry	4.9	62	10	EPA SW846-8260B	02/03/2012 16:33	02/06/2012 17:26	SS
71-97-3	Chloromethane	ND		ug/kg dry	12	62	10	EPA SW846-8260B	02/03/2012 16:33	02/06/2012 17:26	SS
75-59-2	cis-1,2-Dichloroethylene	ND		ug/kg dry	13	62	10	EPA SW846-8260B	02/03/2012 16:33	02/06/2012 17:26	SS
10061-01-5	cis-1,3-Dichloropropylene	ND		ug/kg dry	4.7	62	10	EPA SW846-8260B	02/03/2012 16:33	02/06/2012 17:26	SS
124-48-1	Dibromochloromethane	ND		ug/kg dry	9.0	62	10	EPA SW846-8260B	02/03/2012 16:33	02/06/2012 17:26	SS
74-95-3	Dibromomethane	ND		ug/kg dry	18	62	10	EPA SW846-8260B	02/03/2012 16:33	02/06/2012 17:26	SS
75-71-8	Dichlorodifluoromethane	ND		ug/kg dry	11	62	10	EPA SW846-8260B	02/03/2012 16:33	02/06/2012 17:26	SS
100-41-4	Ethyl Benzene	11	J	ug/kg dry	4.7	62	10	EPA SW846-8260B	02/03/2012 16:33	02/06/2012 17:26	SS
87-68-3	Hexachlorobutadiene	ND		ug/kg dry	5.8	62	10	EPA SW846-8260B	02/03/2012 16:33	02/06/2012 17:26	SS
98-82-8	Isopropylbenzene	110		ug/kg dry	5.3	62	10	EPA SW846-8260B	02/03/2012 16:33	02/06/2012 17:26	SS
1634-04-4	Methyl tert-butyl ether (MTBE)	ND		ug/kg dry	5.1	62	10	EPA SW846-8260B	02/03/2012 16:33	02/06/2012 17:26	SS
75-09-2	Methylene chloride	6.2	B-Dil, J, B	ug/kg dry	1.4	12	1	EPA SW846-8260B	02/03/2012 16:33	02/06/2012 17:26	SS
91-20-3	Naphthalene	ND		ug/kg dry	6.7	120	10	EPA SW846-8260B	02/03/2012 16:33	02/06/2012 17:26	SS
104-51-8	n-Butylbenzene	63		ug/kg dry	4.3	62	10	EPA SW846-8260B	02/03/2012 16:33	02/06/2012 17:26	SS
103-65-1	n-Propylbenzene	120		ug/kg dry	7.8	62	10	EPA SW846-8260B	02/03/2012 16:33	02/06/2012 17:26	SS
95-47-6	o-Xylene	ND		ug/kg dry	6.7	62	10	EPA SW846-8260B	02/03/2012 16:33	02/06/2012 17:26	SS
1330-20-7P/M	p- & m- Xylenes	28	J	ug/kg dry	7.4	120	10	EPA SW846-8260B	02/03/2012 16:33	02/06/2012 17:26	SS
99-87-6	p-Isopropyltoluene	25	J	ug/kg dry	3.4	62	10	EPA SW846-8260B	02/03/2012 16:33	02/06/2012 17:26	SS
135-98-8	sec-Butylbenzene	69		ug/kg dry	7.0	62	10	EPA SW846-8260B	02/03/2012 16:33	02/06/2012 17:26	SS
100-42-5	Styrene	ND		ug/kg dry	5.8	62	10	EPA SW846-8260B	02/03/2012 16:33	02/06/2012 17:26	SS
98-06-6	tert-Butylbenzene	ND		ug/kg dry	6.2	62	10	EPA SW846-8260B	02/03/2012 16:33	02/06/2012 17:26	SS
100-84-8	Tetrachloroethylene	ND		ug/kg dry	7.0	62	10	EPA SW846-8260B	02/03/2012 16:33	02/06/2012 17:26	SS
108-88-3	Toluene	19	J	ug/kg dry	3.1	62	10	EPA SW846-8260B	02/03/2012 16:33	02/06/2012 17:26	SS
156-60-5	trans-1,2-Dichloroethylene	ND		ug/kg dry	8.8	62	10	EPA SW846-8260B	02/03/2012 16:33	02/06/2012 17:26	SS

YORK

ANALYTICAL LABORATORIES, INC.

Sample Information

Client Sample ID: 515W18-SB-6-10'-10.5'-Grab

York Sample ID: 12A0987-06

York Project (SDG) No.
12A0987

Client Project ID
515 West 18th St.

Matrix
Soil

Collection Date/Time
January 26, 2012 3:00 pm

Date Received
01/30/2012

Volatiles Organics, 8260 List

Log-in Notes:

Sample Notes:

Sample Prepared by Method: EPA 5035B

CAS No.	Parameter	Result	Flag	Units	MDL	RL	Dilution	Reference Method	Date/Time Prepared	Date/Time Analyzed	Analyst
10061-02-6	trans-1,3-Dichloropropylene	ND		ug/kg dry	9.2	62	10	EPA SW846-8260B	02/03/2012 16:33	02/06/2012 17:26	SS
79-01-6	Trichloroethylene	ND		ug/kg dry	7.7	62	10	EPA SW846-8260B	02/03/2012 16:33	02/06/2012 17:26	SS
75-69-4	Trichlorofluoromethane	ND		ug/kg dry	12	62	10	EPA SW846-8260B	02/03/2012 16:33	02/06/2012 17:26	SS
75-01-4	Vinyl Chloride	ND		ug/kg dry	13	62	10	EPA SW846-8260B	02/03/2012 16:33	02/06/2012 17:26	SS
1330-20-7	Xylenes, Total	28	J	ug/kg dry	14	190	10	EPA SW846-8260B	02/03/2012 16:33	02/06/2012 17:26	SS

Semi-Volatiles, 8270 Target List

Log-in Notes:

Sample Notes:

Sample Prepared by Method: EPA 3550B

CAS No.	Parameter	Result	Flag	Units	MDL	RL	Dilution	Reference Method	Date/Time Prepared	Date/Time Analyzed	Analyst
120-82-1	1,2,4-Trichlorobenzene	ND		ug/kg dry	113	208	1	EPA SW-846 8270C	02/03/2012 08:34	02/04/2012 02:41	TD
95-50-1	1,2-Dichlorobenzene	ND		ug/kg dry	91.0	208	1	EPA SW-846 8270C	02/03/2012 08:34	02/04/2012 02:41	TD
541-73-1	1,3-Dichlorobenzene	ND		ug/kg dry	99.1	208	1	EPA SW-846 8270C	02/03/2012 08:34	02/04/2012 02:41	TD
106-46-7	1,4-Dichlorobenzene	ND		ug/kg dry	71.3	208	1	EPA SW-846 8270C	02/03/2012 08:34	02/04/2012 02:41	TD
-4	2,4,5-Trichlorophenol	ND		ug/kg dry	56.6	208	1	EPA SW-846 8270C	02/03/2012 08:34	02/04/2012 02:41	TD
88-06-2	2,4,6-Trichlorophenol	ND		ug/kg dry	102	208	1	EPA SW-846 8270C	02/03/2012 08:34	02/04/2012 02:41	TD
120-83-2	2,4-Dichlorophenol	ND		ug/kg dry	85.0	208	1	EPA SW-846 8270C	02/03/2012 08:34	02/04/2012 02:41	TD
105-67-9	2,4-Dimethylphenol	ND		ug/kg dry	66.7	208	1	EPA SW-846 8270C	02/03/2012 08:34	02/04/2012 02:41	TD
51-28-5	2,4-Dinitrophenol	ND		ug/kg dry	175	416	1	EPA SW-846 8270C	02/03/2012 08:34	02/04/2012 02:41	TD
121-14-2	2,4-Dinitrotoluene	ND		ug/kg dry	91.0	208	1	EPA SW-846 8270C	02/03/2012 08:34	02/04/2012 02:41	TD
606-20-2	2,6-Dinitrotoluene	ND		ug/kg dry	99.1	208	1	EPA SW-846 8270C	02/03/2012 08:34	02/04/2012 02:41	TD
91-58-7	2-Chloronaphthalene	ND		ug/kg dry	63.5	208	1	EPA SW-846 8270C	02/03/2012 08:34	02/04/2012 02:41	TD
95-57-8	2-Chlorophenol	ND		ug/kg dry	121	208	1	EPA SW-846 8270C	02/03/2012 08:34	02/04/2012 02:41	TD
91-57-6	2-Methylnaphthalene	ND		ug/kg dry	72.5	208	1	EPA SW-846 8270C	02/03/2012 08:34	02/04/2012 02:41	TD
95-48-7	2-Methylphenol	ND		ug/kg dry	76.5	208	1	EPA SW-846 8270C	02/03/2012 08:34	02/04/2012 02:41	TD
88-75-5	2-Nitrophenol	ND		ug/kg dry	71.3	208	1	EPA SW-846 8270C	02/03/2012 08:34	02/04/2012 02:41	TD
100-01-6	3- & 4-Methylphenols	ND		ug/kg dry	93.6	208	1	EPA SW-846 8270C	02/03/2012 08:34	02/04/2012 02:41	TD
91-94-1	3,3'-Dichlorobenzidine	ND		ug/kg dry	52.4	208	1	EPA SW-846 8270C	02/03/2012 08:34	02/04/2012 02:41	TD
99-09-2	3-Nitroaniline	ND		ug/kg dry	75.4	208	1	EPA SW-846 8270C	02/03/2012 08:34	02/04/2012 02:41	TD
534-52-1	4,6-Dinitro-2-methylphenol	ND		ug/kg dry	157	416	1	EPA SW-846 8270C	02/03/2012 08:34	02/04/2012 02:41	TD
101-55-3	4-Bromophenyl phenyl ether	ND		ug/kg dry	86.8	208	1	EPA SW-846 8270C	02/03/2012 08:34	02/04/2012 02:41	TD
59-50-7	4-Chloro-3-methylphenol	ND		ug/kg dry	22.4	208	1	EPA SW-846 8270C	02/03/2012 08:34	02/04/2012 02:41	TD
106-47-8	4-Chloroaniline	ND		ug/kg dry	82.1	208	1	EPA SW-846 8270C	02/03/2012 08:34	02/04/2012 02:41	TD
-72-3	4-Chlorophenyl phenyl ether	ND		ug/kg dry	60.0	208	1	EPA SW-846 8270C	02/03/2012 08:34	02/04/2012 02:41	TD
100-02-7	4-Nitroaniline	ND		ug/kg dry	69.1	208	1	EPA SW-846 8270C	02/03/2012 08:34	02/04/2012 02:41	TD
56-57-5	4-Nitrophenol	ND		ug/kg dry	75.2	208	1	EPA SW-846 8270C	02/03/2012 08:34	02/04/2012 02:41	TD

YORK

ANALYTICAL LABORATORIES, INC.

Sample Information

Client Sample ID: 515W18-SB-6-10'-10.5'-Grab

York Sample ID: 12A0987-06

York Project (SDG) No.
12A0987

Client Project ID
515 West 18th St.

Matrix
Soil

Collection Date/Time
January 26, 2012 3:00 pm

Date Received
01/30/2012

Semi-Volatiles, 8270 Target List

Log-in Notes:

Sample Notes:

Sample Prepared by Method: EPA 3550B

CAS No.	Parameter	Result	Flag	Units	MDL	RL	Dilution	Reference Method	Date/Time Prepared	Date/Time Analyzed	Analyst
83-32-9	Acenaphthene	ND		ug/kg dry	121	208	1	EPA SW-846 8270C	02/03/2012 08:34	02/04/2012 02:41	TD
208-96-8	Acenaphthylene	ND		ug/kg dry	58.3	208	1	EPA SW-846 8270C	02/03/2012 08:34	02/04/2012 02:41	TD
62-53-3	Aniline	ND		ug/kg dry	74.8	208	1	EPA SW-846 8270C	02/03/2012 08:34	02/04/2012 02:41	TD
120-12-7	Anthracene	250		ug/kg dry	51.6	208	1	EPA SW-846 8270C	02/03/2012 08:34	02/04/2012 02:41	TD
56-55-3	Benzo(a)anthracene	2330		ug/kg dry	80.5	208	1	EPA SW-846 8270C	02/03/2012 08:34	02/04/2012 02:41	TD
50-32-8	Benzo(a)pyrene	2660		ug/kg dry	54.2	208	1	EPA SW-846 8270C	02/03/2012 08:34	02/04/2012 02:41	TD
205-99-2	Benzo(b)fluoranthene	1490		ug/kg dry	79.2	208	1	EPA SW-846 8270C	02/03/2012 08:34	02/04/2012 02:41	TD
191-24-2	Benzo(g,h,i)perylene	316		ug/kg dry	62.5	208	1	EPA SW-846 8270C	02/03/2012 08:34	02/04/2012 02:41	TD
207-08-9	Benzo(k)fluoranthene	1810		ug/kg dry	80.5	208	1	EPA SW-846 8270C	02/03/2012 08:34	02/04/2012 02:41	TD
100-51-6	Benzyl alcohol	ND		ug/kg dry	67.3	208	1	EPA SW-846 8270C	02/03/2012 08:34	02/04/2012 02:41	TD
85-68-7	Benzyl butyl phthalate	ND		ug/kg dry	86.8	208	1	EPA SW-846 8270C	02/03/2012 08:34	02/04/2012 02:41	TD
111-91-1	Bis(2-chloroethoxy)methane	ND		ug/kg dry	76.7	208	1	EPA SW-846 8270C	02/03/2012 08:34	02/04/2012 02:41	TD
111-44-4	Bis(2-chloroethyl)ether	ND		ug/kg dry	70.6	208	1	EPA SW-846 8270C	02/03/2012 08:34	02/04/2012 02:41	TD
10-1	Bis(2-chloroisopropyl)ether	ND		ug/kg dry	77.3	208	1	EPA SW-846 8270C	02/03/2012 08:34	02/04/2012 02:41	TD
117-81-7	Bis(2-ethylhexyl)phthalate	389		ug/kg dry	69.6	208	1	EPA SW-846 8270C	02/03/2012 08:34	02/04/2012 02:41	TD
218-01-9	Chrysene	1750		ug/kg dry	83.8	208	1	EPA SW-846 8270C	02/03/2012 08:34	02/04/2012 02:41	TD
53-70-3	Dibenzo(a,h)anthracene	283		ug/kg dry	52.6	208	1	EPA SW-846 8270C	02/03/2012 08:34	02/04/2012 02:41	TD
132-64-9	Dibenzofuran	ND		ug/kg dry	67.1	208	1	EPA SW-846 8270C	02/03/2012 08:34	02/04/2012 02:41	TD
84-66-2	Diethyl phthalate	ND		ug/kg dry	109	208	1	EPA SW-846 8270C	02/03/2012 08:34	02/04/2012 02:41	TD
131-11-3	Dimethyl phthalate	ND		ug/kg dry	60.0	208	1	EPA SW-846 8270C	02/03/2012 08:34	02/04/2012 02:41	TD
84-74-2	Di-n-butyl phthalate	ND		ug/kg dry	62.1	208	1	EPA SW-846 8270C	02/03/2012 08:34	02/04/2012 02:41	TD
117-84-0	Di-n-octyl phthalate	ND		ug/kg dry	93.6	208	1	EPA SW-846 8270C	02/03/2012 08:34	02/04/2012 02:41	TD
206-44-0	Fluoranthene	1880		ug/kg dry	121	208	1	EPA SW-846 8270C	02/03/2012 08:34	02/04/2012 02:41	TD
86-73-7	Fluorene	71.5	J	ug/kg dry	58.3	208	1	EPA SW-846 8270C	02/03/2012 08:34	02/04/2012 02:41	TD
118-74-1	Hexachlorobenzene	ND		ug/kg dry	33.9	208	1	EPA SW-846 8270C	02/03/2012 08:34	02/04/2012 02:41	TD
87-68-3	Hexachlorobutadiene	ND		ug/kg dry	83.2	208	1	EPA SW-846 8270C	02/03/2012 08:34	02/04/2012 02:41	TD
77-47-4	Hexachlorocyclopentadiene	ND		ug/kg dry	155	208	1	EPA SW-846 8270C	02/03/2012 08:34	02/04/2012 02:41	TD
67-72-1	Hexachloroethane	ND		ug/kg dry	74.8	208	1	EPA SW-846 8270C	02/03/2012 08:34	02/04/2012 02:41	TD
193-39-5	Indeno(1,2,3-cd)pyrene	459		ug/kg dry	76.7	208	1	EPA SW-846 8270C	02/03/2012 08:34	02/04/2012 02:41	TD
78-59-1	Isophorone	ND		ug/kg dry	77.3	208	1	EPA SW-846 8270C	02/03/2012 08:34	02/04/2012 02:41	TD
91-20-3	Naphthalene	116	J	ug/kg dry	62.1	208	1	EPA SW-846 8270C	02/03/2012 08:34	02/04/2012 02:41	TD
98-95-3	Nitrobenzene	ND		ug/kg dry	93.6	208	1	EPA SW-846 8270C	02/03/2012 08:34	02/04/2012 02:41	TD
109-9	N-Nitrosodimethylamine	ND		ug/kg dry	75.2	208	1	EPA SW-846 8270C	02/03/2012 08:34	02/04/2012 02:41	TD
621-64-7	N-nitroso-di-n-propylamine	ND		ug/kg dry	54.3	208	1	EPA SW-846 8270C	02/03/2012 08:34	02/04/2012 02:41	TD
86-30-6	N-Nitrosodiphenylamine	ND		ug/kg dry	121	208	1	EPA SW-846 8270C	02/03/2012 08:34	02/04/2012 02:41	TD

YORK

ANALYTICAL LABORATORIES, INC.

Sample Information

Client Sample ID: 515W18-SB-6-10'-10.5'-Grab

York Sample ID: 12A0987-06

York Project (SDG) No.
12A0987

Client Project ID
515 West 18th St.

Matrix
Soil

Collection Date/Time
January 26, 2012 3:00 pm

Date Received
01/30/2012

Semi-Volatiles, 8270 Target List

Log-in Notes:

Sample Notes:

Sample Prepared by Method: EPA 3550B

CAS No.	Parameter	Result	Flag	Units	MDL	RL	Dilution	Reference Method	Date/Time Prepared	Date/Time Analyzed	Analyst
87-86-5	Pentachlorophenol	ND		ug/kg dry	58.3	208	1	EPA SW-846 8270C	02/03/2012 08:34	02/04/2012 02:41	TD
85-01-8	Phenanthrene	754		ug/kg dry	76.7	208	1	EPA SW-846 8270C	02/03/2012 08:34	02/04/2012 02:41	TD
108-95-2	Phenol	ND		ug/kg dry	83.2	208	1	EPA SW-846 8270C	02/03/2012 08:34	02/04/2012 02:41	TD
129-00-0	Pyrene	2170		ug/kg dry	74.6	208	1	EPA SW-846 8270C	02/03/2012 08:34	02/04/2012 02:41	TD
110-86-1	Pyridine	ND		ug/kg dry	81.2	208	1	EPA SW-846 8270C	02/03/2012 08:34	02/04/2012 02:41	TD

Total Solids

Log-in Notes:

Sample Notes:

Sample Prepared by Method: % Solids Prep

CAS No.	Parameter	Result	Flag	Units	MDL	RL	Dilution	Reference Method	Date/Time Prepared	Date/Time Analyzed	Analyst
solids	% Solids	80.1		%	0.100	0.100	1	SM 2540G	02/03/2012 14:33	02/03/2012 14:33	JCC

Sample Information

Client Sample ID: 515W18-SB-7-7'-8'-Grab

York Sample ID: 12A0987-07

York Project (SDG) No.
12A0987

Client Project ID
515 West 18th St.

Matrix
Soil

Collection Date/Time
January 27, 2012 3:00 pm

Date Received
01/30/2012

Volatile Organics, 8260 List

Log-in Notes:

Sample Notes:

Sample Prepared by Method: EPA 5035B

CAS No.	Parameter	Result	Flag	Units	MDL	RL	Dilution	Reference Method	Date/Time Prepared	Date/Time Analyzed	Analyst
630-20-6	1,1,1,2-Tetrachloroethane	ND		ug/kg dry	6.4	55	10	EPA SW846-8260B	02/03/2012 16:33	02/04/2012 01:31	SS
71-55-6	1,1,1-Trichloroethane	ND		ug/kg dry	11	55	10	EPA SW846-8260B	02/03/2012 16:33	02/04/2012 01:31	SS
79-34-5	1,1,2,2-Tetrachloroethane	ND		ug/kg dry	6.8	55	10	EPA SW846-8260B	02/03/2012 16:33	02/04/2012 01:31	SS
76-13-1	1,1,2-Trichloro-1,2,2-trifluoroethane (Freon 113)	ND		ug/kg dry	7.2	55	10	EPA SW846-8260B	02/03/2012 16:33	02/04/2012 01:31	SS
79-00-5	1,1,2-Trichloroethane	ND		ug/kg dry	7.3	55	10	EPA SW846-8260B	02/03/2012 16:33	02/04/2012 01:31	SS
75-34-3	1,1-Dichloroethane	ND		ug/kg dry	8.2	55	10	EPA SW846-8260B	02/03/2012 16:33	02/04/2012 01:31	SS
75-35-4	1,1-Dichloroethylene	ND		ug/kg dry	16	55	10	EPA SW846-8260B	02/03/2012 16:33	02/04/2012 01:31	SS
563-58-6	1,1-Dichloropropylene	ND		ug/kg dry	5.1	55	10	EPA SW846-8260B	02/03/2012 16:33	02/04/2012 01:31	SS
87-61-6	1,2,3-Trichlorobenzene	ND		ug/kg dry	4.4	110	10	EPA SW846-8260B	02/03/2012 16:33	02/04/2012 01:31	SS
96-18-4	1,2,3-Trichloropropane	ND		ug/kg dry	14	55	10	EPA SW846-8260B	02/03/2012 16:33	02/04/2012 01:31	SS
120-82-1	1,2,4-Trichlorobenzene	ND		ug/kg dry	5.7	110	10	EPA SW846-8260B	02/03/2012 16:33	02/04/2012 01:31	SS
95-63-6	1,2,4-Trimethylbenzene	11	J	ug/kg dry	6.3	55	10	EPA SW846-8260B	02/03/2012 16:33	02/04/2012 01:31	SS
96-12-8	1,2-Dibromo-3-chloropropane	ND		ug/kg dry	16	110	10	EPA SW846-8260B	02/03/2012 16:33	02/04/2012 01:31	SS
93-4	1,2-Dibromoethane	ND		ug/kg dry	8.1	55	10	EPA SW846-8260B	02/03/2012 16:33	02/04/2012 01:31	SS
95-50-1	1,2-Dichlorobenzene	ND		ug/kg dry	7.0	55	10	EPA SW846-8260B	02/03/2012 16:33	02/04/2012 01:31	SS
107-06-2	1,2-Dichloroethane	ND		ug/kg dry	7.8	55	10	EPA SW846-8260B	02/03/2012 16:33	02/04/2012 01:31	SS

YORK

ANALYTICAL LABORATORIES, INC.

Sample Information

Client Sample ID: **515W18-SB-7-7'-8'-Grab**

York Sample ID: **12A0987-07**

York Project (SDG) No.
12A0987

Client Project ID
515 West 18th St.

Matrix
Soil

Collection Date/Time
January 27, 2012 3:00 pm

Date Received
01/30/2012

Volatiles Organics, 8260 List

Log-in Notes:

Sample Notes:

Sample Prepared by Method: EPA 5035B

CAS No.	Parameter	Result	Flag	Units	MDL	RL	Dilution	Reference Method	Date/Time Prepared	Date/Time Analyzed	Analyst
78-87-5	1,2-Dichloropropane	ND		ug/kg dry	2.6	55	10	EPA SW846-8260B	02/03/2012 16:33	02/04/2012 01:31	SS
108-67-8	1,3,5-Trimethylbenzene	ND		ug/kg dry	4.4	55	10	EPA SW846-8260B	02/03/2012 16:33	02/04/2012 01:31	SS
541-73-1	1,3-Dichlorobenzene	ND		ug/kg dry	5.6	55	10	EPA SW846-8260B	02/03/2012 16:33	02/04/2012 01:31	SS
142-28-9	1,3-Dichloropropane	ND		ug/kg dry	8.2	55	10	EPA SW846-8260B	02/03/2012 16:33	02/04/2012 01:31	SS
106-46-7	1,4-Dichlorobenzene	ND		ug/kg dry	8.1	55	10	EPA SW846-8260B	02/03/2012 16:33	02/04/2012 01:31	SS
594-20-7	2,2-Dichloropropane	ND		ug/kg dry	11	55	10	EPA SW846-8260B	02/03/2012 16:33	02/04/2012 01:31	SS
78-93-3	2-Butanone	ND		ug/kg dry	31	110	10	EPA SW846-8260B	02/03/2012 16:33	02/04/2012 01:31	SS
95-49-8	2-Chlorotoluene	ND		ug/kg dry	5.9	55	10	EPA SW846-8260B	02/03/2012 16:33	02/04/2012 01:31	SS
106-43-4	4-Chlorotoluene	ND		ug/kg dry	5.9	55	10	EPA SW846-8260B	02/03/2012 16:33	02/04/2012 01:31	SS
67-64-1	Acetone	160		ug/kg dry	37	110	10	EPA SW846-8260B	02/03/2012 16:33	02/04/2012 01:31	SS
71-43-2	Benzene	ND		ug/kg dry	5.7	55	10	EPA SW846-8260B	02/03/2012 16:33	02/04/2012 01:31	SS
108-86-1	Bromobenzene	ND		ug/kg dry	7.3	55	10	EPA SW846-8260B	02/03/2012 16:33	02/04/2012 01:31	SS
7-5	Bromochloromethane	ND		ug/kg dry	15	55	10	EPA SW846-8260B	02/03/2012 16:33	02/04/2012 01:31	SS
75-27-4	Bromodichloromethane	ND		ug/kg dry	7.4	55	10	EPA SW846-8260B	02/03/2012 16:33	02/04/2012 01:31	SS
75-25-2	Bromoform	ND		ug/kg dry	6.9	55	10	EPA SW846-8260B	02/03/2012 16:33	02/04/2012 01:31	SS
74-83-9	Bromomethane	ND		ug/kg dry	15	55	10	EPA SW846-8260B	02/03/2012 16:33	02/04/2012 01:31	SS
56-23-5	Carbon tetrachloride	ND		ug/kg dry	12	55	10	EPA SW846-8260B	02/03/2012 16:33	02/04/2012 01:31	SS
108-90-7	Chlorobenzene	ND		ug/kg dry	4.2	55	10	EPA SW846-8260B	02/03/2012 16:33	02/04/2012 01:31	SS
75-00-3	Chloroethane	ND		ug/kg dry	9.1	55	10	EPA SW846-8260B	02/03/2012 16:33	02/04/2012 01:31	SS
67-66-3	Chloroform	ND		ug/kg dry	4.3	55	10	EPA SW846-8260B	02/03/2012 16:33	02/04/2012 01:31	SS
74-87-3	Chloromethane	ND		ug/kg dry	11	55	10	EPA SW846-8260B	02/03/2012 16:33	02/04/2012 01:31	SS
156-59-2	cis-1,2-Dichloroethylene	ND		ug/kg dry	11	55	10	EPA SW846-8260B	02/03/2012 16:33	02/04/2012 01:31	SS
10061-01-5	cis-1,3-Dichloropropylene	ND		ug/kg dry	4.2	55	10	EPA SW846-8260B	02/03/2012 16:33	02/04/2012 01:31	SS
124-48-1	Dibromochloromethane	ND		ug/kg dry	8.0	55	10	EPA SW846-8260B	02/03/2012 16:33	02/04/2012 01:31	SS
74-95-3	Dibromomethane	ND		ug/kg dry	16	55	10	EPA SW846-8260B	02/03/2012 16:33	02/04/2012 01:31	SS
75-71-8	Dichlorodifluoromethane	ND		ug/kg dry	9.9	55	10	EPA SW846-8260B	02/03/2012 16:33	02/04/2012 01:31	SS
100-41-4	Ethyl Benzene	ND		ug/kg dry	4.2	55	10	EPA SW846-8260B	02/03/2012 16:33	02/04/2012 01:31	SS
87-68-3	Hexachlorobutadiene	ND		ug/kg dry	5.1	55	10	EPA SW846-8260B	02/03/2012 16:33	02/04/2012 01:31	SS
98-82-8	Isopropylbenzene	ND		ug/kg dry	4.7	55	10	EPA SW846-8260B	02/03/2012 16:33	02/04/2012 01:31	SS
1634-04-4	Methyl tert-butyl ether (MTBE)	ND		ug/kg dry	4.5	55	10	EPA SW846-8260B	02/03/2012 16:33	02/04/2012 01:31	SS
75-09-2	Methylene chloride	62	J, B	ug/kg dry	13	110	10	EPA SW846-8260B	02/03/2012 16:33	02/04/2012 01:31	SS
100-03	Naphthalene	11	J	ug/kg dry	6.0	110	10	EPA SW846-8260B	02/03/2012 16:33	02/04/2012 01:31	SS
51-8	n-Butylbenzene	9.5	J	ug/kg dry	3.8	55	10	EPA SW846-8260B	02/03/2012 16:33	02/04/2012 01:31	SS
103-65-1	n-Propylbenzene	ND		ug/kg dry	6.9	55	10	EPA SW846-8260B	02/03/2012 16:33	02/04/2012 01:31	SS
95-47-6	o-Xylene	ND		ug/kg dry	6.0	55	10	EPA SW846-8260B	02/03/2012 16:33	02/04/2012 01:31	SS

YORK

ANALYTICAL LABORATORIES, INC.

Sample Information

Client Sample ID: 515W18-SB-7'-8'-Grab

York Sample ID: 12A0987-07

York Project (SDG) No.
12A0987

Client Project ID
515 West 18th St.

Matrix
Soil

Collection Date/Time
January 27, 2012 3:00 pm

Date Received
01/30/2012

Volatiles Organics, 8260 List

Log-in Notes:

Sample Notes:

Sample Prepared by Method: EPA 5035B

CAS No.	Parameter	Result	Flag	Units	MDL	RL	Dilution	Reference Method	Date/Time Prepared	Date/Time Analyzed	Analyst
1330-20-7P/M	p- & m- Xylenes	10	J	ug/kg dry	6.6	110	10	EPA SW846-8260B	02/03/2012 16:33	02/04/2012 01:31	SS
99-87-6	p-Isopropyltoluene	ND		ug/kg dry	3.0	55	10	EPA SW846-8260B	02/03/2012 16:33	02/04/2012 01:31	SS
135-98-8	sec-Butylbenzene	ND		ug/kg dry	6.2	55	10	EPA SW846-8260B	02/03/2012 16:33	02/04/2012 01:31	SS
100-42-5	Styrene	ND		ug/kg dry	5.1	55	10	EPA SW846-8260B	02/03/2012 16:33	02/04/2012 01:31	SS
98-06-6	tert-Butylbenzene	ND		ug/kg dry	5.5	55	10	EPA SW846-8260B	02/03/2012 16:33	02/04/2012 01:31	SS
127-18-4	Tetrachloroethylene	ND		ug/kg dry	6.2	55	10	EPA SW846-8260B	02/03/2012 16:33	02/04/2012 01:31	SS
108-88-3	Toluene	ND		ug/kg dry	2.7	55	10	EPA SW846-8260B	02/03/2012 16:33	02/04/2012 01:31	SS
156-60-5	trans-1,2-Dichloroethylene	ND		ug/kg dry	7.8	55	10	EPA SW846-8260B	02/03/2012 16:33	02/04/2012 01:31	SS
10061-02-6	trans-1,3-Dichloropropylene	ND		ug/kg dry	8.1	55	10	EPA SW846-8260B	02/03/2012 16:33	02/04/2012 01:31	SS
79-01-6	Trichloroethylene	ND		ug/kg dry	6.8	55	10	EPA SW846-8260B	02/03/2012 16:33	02/04/2012 01:31	SS
75-69-4	Trichlorofluoromethane	ND		ug/kg dry	11	55	10	EPA SW846-8260B	02/03/2012 16:33	02/04/2012 01:31	SS
75-01-4	Vinyl Chloride	ND		ug/kg dry	12	55	10	EPA SW846-8260B	02/03/2012 16:33	02/04/2012 01:31	SS
7-20-7	Xylenes, Total	ND		ug/kg dry	13	170	10	EPA SW846-8260B	02/03/2012 16:33	02/04/2012 01:31	SS

Semi-Volatiles, 8270 Target List

Log-in Notes:

Sample Notes:

Sample Prepared by Method: EPA 3550B

CAS No.	Parameter	Result	Flag	Units	MDL	RL	Dilution	Reference Method	Date/Time Prepared	Date/Time Analyzed	Analyst
120-82-1	1,2,4-Trichlorobenzene	ND		ug/kg dry	2010	3690	20	EPA SW-846 8270C	02/03/2012 08:34	02/06/2012 12:28	TD
95-50-1	1,2-Dichlorobenzene	ND		ug/kg dry	1610	3690	20	EPA SW-846 8270C	02/03/2012 08:34	02/06/2012 12:28	TD
541-73-1	1,3-Dichlorobenzene	ND		ug/kg dry	1760	3690	20	EPA SW-846 8270C	02/03/2012 08:34	02/06/2012 12:28	TD
106-46-7	1,4-Dichlorobenzene	ND		ug/kg dry	1260	3690	20	EPA SW-846 8270C	02/03/2012 08:34	02/06/2012 12:28	TD
95-95-4	2,4,5-Trichlorophenol	ND		ug/kg dry	1000	3690	20	EPA SW-846 8270C	02/03/2012 08:34	02/06/2012 12:28	TD
88-06-2	2,4,6-Trichlorophenol	ND		ug/kg dry	1800	3690	20	EPA SW-846 8270C	02/03/2012 08:34	02/06/2012 12:28	TD
120-83-2	2,4-Dichlorophenol	ND		ug/kg dry	1510	3690	20	EPA SW-846 8270C	02/03/2012 08:34	02/06/2012 12:28	TD
105-67-9	2,4-Dimethylphenol	ND		ug/kg dry	1180	3690	20	EPA SW-846 8270C	02/03/2012 08:34	02/06/2012 12:28	TD
51-28-5	2,4-Dinitrophenol	ND		ug/kg dry	3100	7370	20	EPA SW-846 8270C	02/03/2012 08:34	02/06/2012 12:28	TD
121-14-2	2,4-Dinitrotoluene	ND		ug/kg dry	1610	3690	20	EPA SW-846 8270C	02/03/2012 08:34	02/06/2012 12:28	TD
606-20-2	2,6-Dinitrotoluene	ND		ug/kg dry	1760	3690	20	EPA SW-846 8270C	02/03/2012 08:34	02/06/2012 12:28	TD
91-58-7	2-Chloronaphthalene	ND		ug/kg dry	1130	3690	20	EPA SW-846 8270C	02/03/2012 08:34	02/06/2012 12:28	TD
95-57-8	2-Chlorophenol	ND		ug/kg dry	2150	3690	20	EPA SW-846 8270C	02/03/2012 08:34	02/06/2012 12:28	TD
91-57-6	2-Methylnaphthalene	ND		ug/kg dry	1280	3690	20	EPA SW-846 8270C	02/03/2012 08:34	02/06/2012 12:28	TD
95-48-7	2-Methylphenol	ND		ug/kg dry	1360	3690	20	EPA SW-846 8270C	02/03/2012 08:34	02/06/2012 12:28	TD
75-5	2-Nitrophenol	ND		ug/kg dry	1260	3690	20	EPA SW-846 8270C	02/03/2012 08:34	02/06/2012 12:28	TD
100-01-6	3- & 4-Methylphenols	ND		ug/kg dry	1660	3690	20	EPA SW-846 8270C	02/03/2012 08:34	02/06/2012 12:28	TD
91-94-1	3,3'-Dichlorobenzidine	ND		ug/kg dry	929	3690	20	EPA SW-846 8270C	02/03/2012 08:34	02/06/2012 12:28	TD

YORK

ANALYTICAL LABORATORIES, INC.

Sample Information

Client Sample ID: 515W18-SB-7-7'-8'-Grab

York Sample ID: 12A0987-07

York Project (SDG) No.
12A0987

Client Project ID
515 West 18th St.

Matrix
Soil

Collection Date/Time
January 27, 2012 3:00 pm

Date Received
01/30/2012

Semi-Volatiles, 8270 Target List

Log-in Notes:

Sample Notes:

Sample Prepared by Method: EPA 3550B

CAS No.	Parameter	Result	Flag	Units	MDL	RL	Dilution	Reference Method	Date/Time Prepared	Date/Time Analyzed	Analyst
99-09-2	3-Nitroaniline	ND		ug/kg dry	1340	3690	20	EPA SW-846 8270C	02/03/2012 08:34	02/06/2012 12:28	TD
534-52-1	4,6-Dinitro-2-methylphenol	ND		ug/kg dry	2790	7370	20	EPA SW-846 8270C	02/03/2012 08:34	02/06/2012 12:28	TD
101-55-3	4-Bromophenyl phenyl ether	ND		ug/kg dry	1540	3690	20	EPA SW-846 8270C	02/03/2012 08:34	02/06/2012 12:28	TD
59-50-7	4-Chloro-3-methylphenol	ND		ug/kg dry	397	3690	20	EPA SW-846 8270C	02/03/2012 08:34	02/06/2012 12:28	TD
106-47-8	4-Chloroaniline	ND		ug/kg dry	1460	3690	20	EPA SW-846 8270C	02/03/2012 08:34	02/06/2012 12:28	TD
7005-72-3	4-Chlorophenyl phenyl ether	ND		ug/kg dry	1060	3690	20	EPA SW-846 8270C	02/03/2012 08:34	02/06/2012 12:28	TD
100-02-7	4-Nitroaniline	ND		ug/kg dry	1220	3690	20	EPA SW-846 8270C	02/03/2012 08:34	02/06/2012 12:28	TD
56-57-5	4-Nitrophenol	ND		ug/kg dry	1330	3690	20	EPA SW-846 8270C	02/03/2012 08:34	02/06/2012 12:28	TD
83-32-9	Acenaphthene	ND		ug/kg dry	2140	3690	20	EPA SW-846 8270C	02/03/2012 08:34	02/06/2012 12:28	TD
208-96-8	Acenaphthylene	ND		ug/kg dry	1030	3690	20	EPA SW-846 8270C	02/03/2012 08:34	02/06/2012 12:28	TD
62-53-3	Aniline	ND		ug/kg dry	1330	3690	20	EPA SW-846 8270C	02/03/2012 08:34	02/06/2012 12:28	TD
120-12-7	Anthracene	1670	J	ug/kg dry	914	3690	20	EPA SW-846 8270C	02/03/2012 08:34	02/06/2012 12:28	TD
15-3	Benzo(a)anthracene	6360		ug/kg dry	1430	3690	20	EPA SW-846 8270C	02/03/2012 08:34	02/06/2012 12:28	TD
120-12-8	Benzo(a)pyrene	6630		ug/kg dry	961	3690	20	EPA SW-846 8270C	02/03/2012 08:34	02/06/2012 12:28	TD
205-99-2	Benzo(b)fluoranthene	5260		ug/kg dry	1400	3690	20	EPA SW-846 8270C	02/03/2012 08:34	02/06/2012 12:28	TD
191-24-2	Benzo(g,h,i)perylene	1420	J	ug/kg dry	1110	3690	20	EPA SW-846 8270C	02/03/2012 08:34	02/06/2012 12:28	TD
207-08-9	Benzo(k)fluoranthene	6150		ug/kg dry	1430	3690	20	EPA SW-846 8270C	02/03/2012 08:34	02/06/2012 12:28	TD
100-51-6	Benzyl alcohol	ND		ug/kg dry	1190	3690	20	EPA SW-846 8270C	02/03/2012 08:34	02/06/2012 12:28	TD
85-68-7	Benzyl butyl phthalate	ND		ug/kg dry	1540	3690	20	EPA SW-846 8270C	02/03/2012 08:34	02/06/2012 12:28	TD
111-91-1	Bis(2-chloroethoxy)methane	ND		ug/kg dry	1360	3690	20	EPA SW-846 8270C	02/03/2012 08:34	02/06/2012 12:28	TD
111-44-4	Bis(2-chloroethyl)ether	ND		ug/kg dry	1250	3690	20	EPA SW-846 8270C	02/03/2012 08:34	02/06/2012 12:28	TD
108-60-1	Bis(2-chloroisopropyl)ether	ND		ug/kg dry	1370	3690	20	EPA SW-846 8270C	02/03/2012 08:34	02/06/2012 12:28	TD
117-81-7	Bis(2-ethylhexyl)phthalate	ND		ug/kg dry	1230	3690	20	EPA SW-846 8270C	02/03/2012 08:34	02/06/2012 12:28	TD
218-01-9	Chrysene	5690		ug/kg dry	1490	3690	20	EPA SW-846 8270C	02/03/2012 08:34	02/06/2012 12:28	TD
53-70-3	Dibenzo(a,h)anthracene	ND		ug/kg dry	932	3690	20	EPA SW-846 8270C	02/03/2012 08:34	02/06/2012 12:28	TD
132-64-9	Dibenzofuran	ND		ug/kg dry	1190	3690	20	EPA SW-846 8270C	02/03/2012 08:34	02/06/2012 12:28	TD
84-66-2	Diethyl phthalate	ND		ug/kg dry	1940	3690	20	EPA SW-846 8270C	02/03/2012 08:34	02/06/2012 12:28	TD
131-11-3	Dimethyl phthalate	ND		ug/kg dry	1060	3690	20	EPA SW-846 8270C	02/03/2012 08:34	02/06/2012 12:28	TD
84-74-2	Di-n-butyl phthalate	ND		ug/kg dry	1100	3690	20	EPA SW-846 8270C	02/03/2012 08:34	02/06/2012 12:28	TD
117-84-0	Di-n-octyl phthalate	ND		ug/kg dry	1660	3690	20	EPA SW-846 8270C	02/03/2012 08:34	02/06/2012 12:28	TD
206-44-0	Fluoranthene	9580		ug/kg dry	2140	3690	20	EPA SW-846 8270C	02/03/2012 08:34	02/06/2012 12:28	TD
86-73-7	Fluorene	ND		ug/kg dry	1030	3690	20	EPA SW-846 8270C	02/03/2012 08:34	02/06/2012 12:28	TD
74-1	Hexachlorobenzene	ND		ug/kg dry	601	3690	20	EPA SW-846 8270C	02/03/2012 08:34	02/06/2012 12:28	TD
87-68-3	Hexachlorobutadiene	ND		ug/kg dry	1470	3690	20	EPA SW-846 8270C	02/03/2012 08:34	02/06/2012 12:28	TD
77-47-4	Hexachlorocyclopentadiene	ND		ug/kg dry	2740	3690	20	EPA SW-846 8270C	02/03/2012 08:34	02/06/2012 12:28	TD

YORK

ANALYTICAL LABORATORIES, INC.

Sample Information

Client Sample ID: 515W18-SB-7-7'-8'-Grab

York Sample ID: 12A0987-07

York Project (SDG) No.
12A0987

Client Project ID
515 West 18th St.

Matrix
Soil

Collection Date/Time
January 27, 2012 3:00 pm

Date Received
01/30/2012

Semi-Volatiles, 8270 Target List

Log-in Notes:

Sample Notes:

Sample Prepared by Method: EPA 3550B

CAS No.	Parameter	Result	Flag	Units	MDL	RL	Dilution	Reference Method	Date/Time Prepared	Date/Time Analyzed	Analyst
67-72-1	Hexachloroethane	ND		ug/kg dry	1330	3690	20	EPA SW-846 8270C	02/03/2012 08:34	02/06/2012 12:28	TD
193-39-5	Indeno(1,2,3-cd)pyrene	1960	J	ug/kg dry	1360	3690	20	EPA SW-846 8270C	02/03/2012 08:34	02/06/2012 12:28	TD
78-59-1	Isophorone	ND		ug/kg dry	1370	3690	20	EPA SW-846 8270C	02/03/2012 08:34	02/06/2012 12:28	TD
91-20-3	Naphthalene	ND		ug/kg dry	1100	3690	20	EPA SW-846 8270C	02/03/2012 08:34	02/06/2012 12:28	TD
98-95-3	Nitrobenzene	ND		ug/kg dry	1660	3690	20	EPA SW-846 8270C	02/03/2012 08:34	02/06/2012 12:28	TD
62-75-9	N-Nitrosodimethylamine	ND		ug/kg dry	1330	3690	20	EPA SW-846 8270C	02/03/2012 08:34	02/06/2012 12:28	TD
621-64-7	N-nitroso-di-n-propylamine	ND		ug/kg dry	962	3690	20	EPA SW-846 8270C	02/03/2012 08:34	02/06/2012 12:28	TD
86-30-6	N-Nitrosodiphenylamine	ND		ug/kg dry	2140	3690	20	EPA SW-846 8270C	02/03/2012 08:34	02/06/2012 12:28	TD
87-86-5	Pentachlorophenol	ND		ug/kg dry	1030	3690	20	EPA SW-846 8270C	02/03/2012 08:34	02/06/2012 12:28	TD
85-01-8	Phenanthrene	5240		ug/kg dry	1360	3690	20	EPA SW-846 8270C	02/03/2012 08:34	02/06/2012 12:28	TD
108-95-2	Phenol	ND		ug/kg dry	1480	3690	20	EPA SW-846 8270C	02/03/2012 08:34	02/06/2012 12:28	TD
129-00-0	Pyrene	6840		ug/kg dry	1320	3690	20	EPA SW-846 8270C	02/03/2012 08:34	02/06/2012 12:28	TD
123-86-1	Pyridine	ND		ug/kg dry	1440	3690	20	EPA SW-846 8270C	02/03/2012 08:34	02/06/2012 12:28	TD

Total Solids

Log-in Notes:

Sample Notes:

Sample Prepared by Method: % Solids Prep

CAS No.	Parameter	Result	Flag	Units	MDL	RL	Dilution	Reference Method	Date/Time Prepared	Date/Time Analyzed	Analyst
solids	% Solids	90.4		%	0.100	0.100	1	SM 2540G	02/03/2012 14:33	02/03/2012 14:33	JCC

Sample Information

Client Sample ID: 515W18-SB-8-8'-9'-Grab

York Sample ID: 12A0987-08

York Project (SDG) No.
12A0987

Client Project ID
515 West 18th St.

Matrix
Soil

Collection Date/Time
January 27, 2012 3:00 pm

Date Received
01/30/2012

Volatile Organics, 8260 List

Log-in Notes:

Sample Notes:

Sample Prepared by Method: EPA 5035B

CAS No.	Parameter	Result	Flag	Units	MDL	RL	Dilution	Reference Method	Date/Time Prepared	Date/Time Analyzed	Analyst
630-20-6	1,1,1,2-Tetrachloroethane	ND		ug/kg dry	1.3	12	2	EPA SW846-8260B	02/03/2012 16:33	02/07/2012 12:17	SS
71-55-6	1,1,1-Trichloroethane	ND		ug/kg dry	2.4	12	2	EPA SW846-8260B	02/03/2012 16:33	02/07/2012 12:17	SS
79-34-5	1,1,2,2-Tetrachloroethane	ND		ug/kg dry	1.4	12	2	EPA SW846-8260B	02/03/2012 16:33	02/07/2012 12:17	SS
76-13-1	1,1,2-Trichloro-1,2,2-trifluoroethane (Freon 113)	ND		ug/kg dry	1.5	12	2	EPA SW846-8260B	02/03/2012 16:33	02/07/2012 12:17	SS
79-00-5	1,1,2-Trichloroethane	ND		ug/kg dry	1.5	12	2	EPA SW846-8260B	02/03/2012 16:33	02/07/2012 12:17	SS
78-04-3	1,1-Dichloroethane	ND		ug/kg dry	1.7	12	2	EPA SW846-8260B	02/03/2012 16:33	02/07/2012 12:17	SS
75-35-4	1,1-Dichloroethylene	ND		ug/kg dry	3.3	12	2	EPA SW846-8260B	02/03/2012 16:33	02/07/2012 12:17	SS
563-58-6	1,1-Dichloropropylene	ND		ug/kg dry	1.1	12	2	EPA SW846-8260B	02/03/2012 16:33	02/07/2012 12:17	SS

YORK

ANALYTICAL LABORATORIES, INC.

Sample Information

Client Sample ID: 515W18-SB-8-8'-9'-Grab

York Sample ID: 12A0987-08

York Project (SDG) No.
12A0987

Client Project ID
515 West 18th St.

Matrix
Soil

Collection Date/Time
January 27, 2012 3:00 pm

Date Received
01/30/2012

Volatile Organics, 8260 List

Log-in Notes:

Sample Notes:

Sample Prepared by Method: EPA 5035B

CAS No.	Parameter	Result	Flag	Units	MDL	RL	Dilution	Reference Method	Date/Time Prepared	Date/Time Analyzed	Analyst
87-61-6	1,2,3-Trichlorobenzene	ND		ug/kg dry	0.92	23	2	EPA SW846-8260B	02/03/2012 16:33	02/07/2012 12:17	SS
96-18-4	1,2,3-Trichloropropane	ND		ug/kg dry	2.8	12	2	EPA SW846-8260B	02/03/2012 16:33	02/07/2012 12:17	SS
120-82-1	1,2,4-Trichlorobenzene	ND		ug/kg dry	1.2	23	2	EPA SW846-8260B	02/03/2012 16:33	02/07/2012 12:17	SS
95-63-6	1,2,4-Trimethylbenzene	ND		ug/kg dry	1.3	12	2	EPA SW846-8260B	02/03/2012 16:33	02/07/2012 12:17	SS
96-12-8	1,2-Dibromo-3-chloropropane	ND		ug/kg dry	3.3	23	2	EPA SW846-8260B	02/03/2012 16:33	02/07/2012 12:17	SS
106-93-4	1,2-Dibromoethane	ND		ug/kg dry	1.7	12	2	EPA SW846-8260B	02/03/2012 16:33	02/07/2012 12:17	SS
95-50-1	1,2-Dichlorobenzene	ND		ug/kg dry	1.5	12	2	EPA SW846-8260B	02/03/2012 16:33	02/07/2012 12:17	SS
107-06-2	1,2-Dichloroethane	ND		ug/kg dry	1.6	12	2	EPA SW846-8260B	02/03/2012 16:33	02/07/2012 12:17	SS
78-87-5	1,2-Dichloropropane	ND		ug/kg dry	0.55	12	2	EPA SW846-8260B	02/03/2012 16:33	02/07/2012 12:17	SS
108-67-8	1,3,5-Trimethylbenzene	ND		ug/kg dry	0.92	12	2	EPA SW846-8260B	02/03/2012 16:33	02/07/2012 12:17	SS
541-73-1	1,3-Dichlorobenzene	ND		ug/kg dry	1.2	12	2	EPA SW846-8260B	02/03/2012 16:33	02/07/2012 12:17	SS
142-28-9	1,3-Dichloropropane	ND		ug/kg dry	1.7	12	2	EPA SW846-8260B	02/03/2012 16:33	02/07/2012 12:17	SS
46-7	1,4-Dichlorobenzene	ND		ug/kg dry	1.7	12	2	EPA SW846-8260B	02/03/2012 16:33	02/07/2012 12:17	SS
594-20-7	2,2-Dichloropropane	ND		ug/kg dry	2.4	12	2	EPA SW846-8260B	02/03/2012 16:33	02/07/2012 12:17	SS
78-93-3	2-Butanone	ND		ug/kg dry	6.4	23	2	EPA SW846-8260B	02/03/2012 16:33	02/07/2012 12:17	SS
95-49-8	2-Chlorotoluene	ND		ug/kg dry	1.2	12	2	EPA SW846-8260B	02/03/2012 16:33	02/07/2012 12:17	SS
106-43-4	4-Chlorotoluene	ND		ug/kg dry	1.2	12	2	EPA SW846-8260B	02/03/2012 16:33	02/07/2012 12:17	SS
67-64-1	Acetone	21	J, B	ug/kg dry	7.7	23	2	EPA SW846-8260B	02/03/2012 16:33	02/07/2012 12:17	SS
71-43-2	Benzene	ND		ug/kg dry	1.2	12	2	EPA SW846-8260B	02/03/2012 16:33	02/07/2012 12:17	SS
108-86-1	Bromobenzene	ND		ug/kg dry	1.5	12	2	EPA SW846-8260B	02/03/2012 16:33	02/07/2012 12:17	SS
74-97-5	Bromochloromethane	ND		ug/kg dry	3.2	12	2	EPA SW846-8260B	02/03/2012 16:33	02/07/2012 12:17	SS
75-27-4	Bromodichloromethane	ND		ug/kg dry	1.5	12	2	EPA SW846-8260B	02/03/2012 16:33	02/07/2012 12:17	SS
75-25-2	Bromoform	ND		ug/kg dry	1.4	12	2	EPA SW846-8260B	02/03/2012 16:33	02/07/2012 12:17	SS
74-83-9	Bromomethane	ND		ug/kg dry	3.1	12	2	EPA SW846-8260B	02/03/2012 16:33	02/07/2012 12:17	SS
56-23-5	Carbon tetrachloride	ND		ug/kg dry	2.6	12	2	EPA SW846-8260B	02/03/2012 16:33	02/07/2012 12:17	SS
108-90-7	Chlorobenzene	ND		ug/kg dry	0.87	12	2	EPA SW846-8260B	02/03/2012 16:33	02/07/2012 12:17	SS
75-00-3	Chloroethane	ND		ug/kg dry	1.9	12	2	EPA SW846-8260B	02/03/2012 16:33	02/07/2012 12:17	SS
67-66-3	Chloroform	ND		ug/kg dry	0.90	12	2	EPA SW846-8260B	02/03/2012 16:33	02/07/2012 12:17	SS
74-87-3	Chloromethane	ND		ug/kg dry	2.2	12	2	EPA SW846-8260B	02/03/2012 16:33	02/07/2012 12:17	SS
156-59-2	cis-1,2-Dichloroethylene	ND		ug/kg dry	2.4	12	2	EPA SW846-8260B	02/03/2012 16:33	02/07/2012 12:17	SS
10061-01-5	cis-1,3-Dichloropropylene	ND		ug/kg dry	0.87	12	2	EPA SW846-8260B	02/03/2012 16:33	02/07/2012 12:17	SS
4-48-1	Dibromochloromethane	ND		ug/kg dry	1.7	12	2	EPA SW846-8260B	02/03/2012 16:33	02/07/2012 12:17	SS
1-95-3	Dibromomethane	ND		ug/kg dry	3.3	12	2	EPA SW846-8260B	02/03/2012 16:33	02/07/2012 12:17	SS
75-71-8	Dichlorodifluoromethane	ND		ug/kg dry	2.1	12	2	EPA SW846-8260B	02/03/2012 16:33	02/07/2012 12:17	SS
100-41-4	Ethyl Benzene	ND		ug/kg dry	0.87	12	2	EPA SW846-8260B	02/03/2012 16:33	02/07/2012 12:17	SS

YORK

ANALYTICAL LABORATORIES, INC.

Sample Information

Client Sample ID: 515W18-SB-8-8'-9'-Grab

York Sample ID: 12A0987-08

York Project (SDG) No.
12A0987

Client Project ID
515 West 18th St.

Matrix
Soil

Collection Date/Time
January 27, 2012 3:00 pm

Date Received
01/30/2012

Volatile Organics, 8260 List

Log-in Notes:

Sample Notes:

Sample Prepared by Method: EPA 5035B

CAS No.	Parameter	Result	Flag	Units	MDL	RL	Dilution	Reference Method	Date/Time Prepared	Date/Time Analyzed	Analyst
87-68-3	Hexachlorobutadiene	ND		ug/kg dry	1.1	12	2	EPA SW846-8260B	02/03/2012 16:33	02/07/2012 12:17	SS
98-82-8	Isopropylbenzene	ND		ug/kg dry	0.97	12	2	EPA SW846-8260B	02/03/2012 16:33	02/07/2012 12:17	SS
1634-04-4	Methyl tert-butyl ether (MTBE)	ND		ug/kg dry	0.95	12	2	EPA SW846-8260B	02/03/2012 16:33	02/07/2012 12:17	SS
75-09-2	Methylene chloride	15	J, B	ug/kg dry	2.6	23	2	EPA SW846-8260B	02/03/2012 16:33	02/07/2012 12:17	SS
91-20-3	Naphthalene	ND		ug/kg dry	1.2	23	2	EPA SW846-8260B	02/03/2012 16:33	02/07/2012 12:17	SS
104-51-8	n-Butylbenzene	ND		ug/kg dry	0.80	12	2	EPA SW846-8260B	02/03/2012 16:33	02/07/2012 12:17	SS
103-65-1	n-Propylbenzene	ND		ug/kg dry	1.4	12	2	EPA SW846-8260B	02/03/2012 16:33	02/07/2012 12:17	SS
95-47-6	o-Xylene	ND		ug/kg dry	1.2	12	2	EPA SW846-8260B	02/03/2012 16:33	02/07/2012 12:17	SS
1330-20-7P/M	p- & m- Xylenes	ND		ug/kg dry	1.4	23	2	EPA SW846-8260B	02/03/2012 16:33	02/07/2012 12:17	SS
99-87-6	p-Isopropyltoluene	ND		ug/kg dry	0.62	12	2	EPA SW846-8260B	02/03/2012 16:33	02/07/2012 12:17	SS
135-98-8	sec-Butylbenzene	ND		ug/kg dry	1.3	12	2	EPA SW846-8260B	02/03/2012 16:33	02/07/2012 12:17	SS
100-42-5	Styrene	ND		ug/kg dry	1.1	12	2	EPA SW846-8260B	02/03/2012 16:33	02/07/2012 12:17	SS
100-66-6	tert-Butylbenzene	ND		ug/kg dry	1.1	12	2	EPA SW846-8260B	02/03/2012 16:33	02/07/2012 12:17	SS
100-118-4	Tetrachloroethylene	ND		ug/kg dry	1.3	12	2	EPA SW846-8260B	02/03/2012 16:33	02/07/2012 12:17	SS
108-88-3	Toluene	ND		ug/kg dry	0.57	12	2	EPA SW846-8260B	02/03/2012 16:33	02/07/2012 12:17	SS
156-60-5	trans-1,2-Dichloroethylene	ND		ug/kg dry	1.6	12	2	EPA SW846-8260B	02/03/2012 16:33	02/07/2012 12:17	SS
10061-02-6	trans-1,3-Dichloropropylene	ND		ug/kg dry	1.7	12	2	EPA SW846-8260B	02/03/2012 16:33	02/07/2012 12:17	SS
79-01-6	Trichloroethylene	ND		ug/kg dry	1.4	12	2	EPA SW846-8260B	02/03/2012 16:33	02/07/2012 12:17	SS
75-69-4	Trichlorofluoromethane	ND		ug/kg dry	2.3	12	2	EPA SW846-8260B	02/03/2012 16:33	02/07/2012 12:17	SS
75-01-4	Vinyl Chloride	ND		ug/kg dry	2.4	12	2	EPA SW846-8260B	02/03/2012 16:33	02/07/2012 12:17	SS
1330-20-7	Xylenes, Total	ND		ug/kg dry	2.6	35	2	EPA SW846-8260B	02/03/2012 16:33	02/07/2012 12:17	SS

Semi-Volatiles, 8270 Target List

Log-in Notes:

Sample Notes:

Sample Prepared by Method: EPA 3550B

CAS No.	Parameter	Result	Flag	Units	MDL	RL	Dilution	Reference Method	Date/Time Prepared	Date/Time Analyzed	Analyst
120-82-1	1,2,4-Trichlorobenzene	ND		ug/kg dry	105	192	1	EPA SW-846 8270C	02/03/2012 08:34	02/04/2012 03:46	TD
95-50-1	1,2-Dichlorobenzene	ND		ug/kg dry	84.1	192	1	EPA SW-846 8270C	02/03/2012 08:34	02/04/2012 03:46	TD
541-73-1	1,3-Dichlorobenzene	ND		ug/kg dry	91.5	192	1	EPA SW-846 8270C	02/03/2012 08:34	02/04/2012 03:46	TD
106-46-7	1,4-Dichlorobenzene	ND		ug/kg dry	65.9	192	1	EPA SW-846 8270C	02/03/2012 08:34	02/04/2012 03:46	TD
95-95-4	2,4,5-Trichlorophenol	ND		ug/kg dry	52.3	192	1	EPA SW-846 8270C	02/03/2012 08:34	02/04/2012 03:46	TD
88-06-2	2,4,6-Trichlorophenol	ND		ug/kg dry	94.0	192	1	EPA SW-846 8270C	02/03/2012 08:34	02/04/2012 03:46	TD
120-83-2	2,4-Dichlorophenol	ND		ug/kg dry	78.5	192	1	EPA SW-846 8270C	02/03/2012 08:34	02/04/2012 03:46	TD
100-7-9	2,4-Dimethylphenol	ND		ug/kg dry	61.6	192	1	EPA SW-846 8270C	02/03/2012 08:34	02/04/2012 03:46	TD
51-28-5	2,4-Dinitrophenol	ND		ug/kg dry	161	384	1	EPA SW-846 8270C	02/03/2012 08:34	02/04/2012 03:46	TD
121-14-2	2,4-Dinitrotoluene	ND		ug/kg dry	84.1	192	1	EPA SW-846 8270C	02/03/2012 08:34	02/04/2012 03:46	TD

YORK

ANALYTICAL LABORATORIES, INC.

Sample Information

Client Sample ID: 515W18-SB-8-8'-9'-Grab

York Sample ID: 12A0987-08

York Project (SDG) No.
12A0987

Client Project ID
515 West 18th St.

Matrix
Soil

Collection Date/Time
January 27, 2012 3:00 pm

Date Received
01/30/2012

Semi-Volatiles, 8270 Target List

Log-in Notes:

Sample Notes:

Sample Prepared by Method: EPA 3550B

CAS No.	Parameter	Result	Flag	Units	MDL	RL	Dilution	Reference Method	Date/Time Prepared	Date/Time Analyzed	Analyst
606-20-2	2,6-Dinitrotoluene	ND		ug/kg dry	91.5	192	1	EPA SW-846 8270C	02/03/2012 08:34	02/04/2012 03:46	TD
91-58-7	2-Chloronaphthalene	ND		ug/kg dry	58.7	192	1	EPA SW-846 8270C	02/03/2012 08:34	02/04/2012 03:46	TD
95-57-8	2-Chlorophenol	ND		ug/kg dry	112	192	1	EPA SW-846 8270C	02/03/2012 08:34	02/04/2012 03:46	TD
91-57-6	2-Methylnaphthalene	ND		ug/kg dry	66.9	192	1	EPA SW-846 8270C	02/03/2012 08:34	02/04/2012 03:46	TD
95-48-7	2-Methylphenol	ND		ug/kg dry	70.7	192	1	EPA SW-846 8270C	02/03/2012 08:34	02/04/2012 03:46	TD
88-75-5	2-Nitrophenol	ND		ug/kg dry	65.9	192	1	EPA SW-846 8270C	02/03/2012 08:34	02/04/2012 03:46	TD
100-01-6	3- & 4-Methylphenols	ND		ug/kg dry	86.4	192	1	EPA SW-846 8270C	02/03/2012 08:34	02/04/2012 03:46	TD
91-94-1	3,3'-Dichlorobenzidine	ND		ug/kg dry	48.4	192	1	EPA SW-846 8270C	02/03/2012 08:34	02/04/2012 03:46	TD
99-09-2	3-Nitroaniline	ND		ug/kg dry	69.7	192	1	EPA SW-846 8270C	02/03/2012 08:34	02/04/2012 03:46	TD
534-52-1	4,6-Dinitro-2-methylphenol	ND		ug/kg dry	145	384	1	EPA SW-846 8270C	02/03/2012 08:34	02/04/2012 03:46	TD
101-55-3	4-Bromophenyl phenyl ether	ND		ug/kg dry	80.1	192	1	EPA SW-846 8270C	02/03/2012 08:34	02/04/2012 03:46	TD
59-50-7	4-Chloro-3-methylphenol	ND		ug/kg dry	20.7	192	1	EPA SW-846 8270C	02/03/2012 08:34	02/04/2012 03:46	TD
7-8	4-Chloroaniline	ND		ug/kg dry	75.9	192	1	EPA SW-846 8270C	02/03/2012 08:34	02/04/2012 03:46	TD
7005-72-3	4-Chlorophenyl phenyl ether	ND		ug/kg dry	55.4	192	1	EPA SW-846 8270C	02/03/2012 08:34	02/04/2012 03:46	TD
100-02-7	4-Nitroaniline	ND		ug/kg dry	63.8	192	1	EPA SW-846 8270C	02/03/2012 08:34	02/04/2012 03:46	TD
56-57-5	4-Nitrophenol	ND		ug/kg dry	69.5	192	1	EPA SW-846 8270C	02/03/2012 08:34	02/04/2012 03:46	TD
83-32-9	Acenaphthiene	ND		ug/kg dry	111	192	1	EPA SW-846 8270C	02/03/2012 08:34	02/04/2012 03:46	TD
208-96-8	Acenaphthylene	ND		ug/kg dry	53.8	192	1	EPA SW-846 8270C	02/03/2012 08:34	02/04/2012 03:46	TD
62-53-3	Aniline	ND		ug/kg dry	69.1	192	1	EPA SW-846 8270C	02/03/2012 08:34	02/04/2012 03:46	TD
120-12-7	Anthracene	ND		ug/kg dry	47.6	192	1	EPA SW-846 8270C	02/03/2012 08:34	02/04/2012 03:46	TD
56-55-3	Benzo(a)anthracene	ND		ug/kg dry	74.3	192	1	EPA SW-846 8270C	02/03/2012 08:34	02/04/2012 03:46	TD
50-32-8	Benzo(a)pyrene	ND		ug/kg dry	50.1	192	1	EPA SW-846 8270C	02/03/2012 08:34	02/04/2012 03:46	TD
205-99-2	Benzo(b)fluoranthene	ND		ug/kg dry	73.1	192	1	EPA SW-846 8270C	02/03/2012 08:34	02/04/2012 03:46	TD
191-24-2	Benzo(g,h,i)perylene	ND		ug/kg dry	57.8	192	1	EPA SW-846 8270C	02/03/2012 08:34	02/04/2012 03:46	TD
207-08-9	Benzo(k)fluoranthene	ND		ug/kg dry	74.4	192	1	EPA SW-846 8270C	02/03/2012 08:34	02/04/2012 03:46	TD
100-51-6	Benzyl alcohol	ND		ug/kg dry	62.2	192	1	EPA SW-846 8270C	02/03/2012 08:34	02/04/2012 03:46	TD
85-68-7	Benzyl butyl phthalate	ND		ug/kg dry	80.2	192	1	EPA SW-846 8270C	02/03/2012 08:34	02/04/2012 03:46	TD
111-91-1	Bis(2-chloroethoxy)methane	ND		ug/kg dry	70.8	192	1	EPA SW-846 8270C	02/03/2012 08:34	02/04/2012 03:46	TD
111-44-4	Bis(2-chloroethyl)ether	ND		ug/kg dry	65.3	192	1	EPA SW-846 8270C	02/03/2012 08:34	02/04/2012 03:46	TD
108-60-1	Bis(2-chloroisopropyl)ether	ND		ug/kg dry	71.4	192	1	EPA SW-846 8270C	02/03/2012 08:34	02/04/2012 03:46	TD
117-81-7	Bis(2-ethylhexyl)phthalate	150	J	ug/kg dry	64.3	192	1	EPA SW-846 8270C	02/03/2012 08:34	02/04/2012 03:46	TD
71-9	Chrysene	ND		ug/kg dry	77.4	192	1	EPA SW-846 8270C	02/03/2012 08:34	02/04/2012 03:46	TD
170-3	Dibenzo(a,h)anthracene	ND		ug/kg dry	48.6	192	1	EPA SW-846 8270C	02/03/2012 08:34	02/04/2012 03:46	TD
132-64-9	Dibenzofuran	ND		ug/kg dry	62.0	192	1	EPA SW-846 8270C	02/03/2012 08:34	02/04/2012 03:46	TD
84-66-2	Diethyl phthalate	ND		ug/kg dry	101	192	1	EPA SW-846 8270C	02/03/2012 08:34	02/04/2012 03:46	TD

YORK

ANALYTICAL LABORATORIES, INC.

Sample Information

Client Sample ID: 515W18-SB-8-8'-9'-Grab

York Sample ID: 12A0987-08

York Project (SDG) No.
12A0987

Client Project ID
515 West 18th St.

Matrix
Soil

Collection Date/Time
January 27, 2012 3:00 pm

Date Received
01/30/2012

Semi-Volatiles, 8270 Target List

Log-in Notes:

Sample Notes:

Sample Prepared by Method: EPA 3550B

CAS No.	Parameter	Result	Flag	Units	MDL	RL	Dilution	Reference Method	Date/Time Prepared	Date/Time Analyzed	Analyst
131-11-3	Dimethyl phthalate	ND		ug/kg dry	55.4	192	1	EPA SW-846 8270C	02/03/2012 08:34	02/04/2012 03:46	TD
84-74-2	Di-n-butyl phthalate	ND		ug/kg dry	57.4	192	1	EPA SW-846 8270C	02/03/2012 08:34	02/04/2012 03:46	TD
117-84-0	Di-n-octyl phthalate	ND		ug/kg dry	86.4	192	1	EPA SW-846 8270C	02/03/2012 08:34	02/04/2012 03:46	TD
206-44-0	Fluoranthene	ND		ug/kg dry	111	192	1	EPA SW-846 8270C	02/03/2012 08:34	02/04/2012 03:46	TD
86-73-7	Fluorene	ND		ug/kg dry	53.8	192	1	EPA SW-846 8270C	02/03/2012 08:34	02/04/2012 03:46	TD
118-74-1	Hexachlorobenzene	ND		ug/kg dry	31.3	192	1	EPA SW-846 8270C	02/03/2012 08:34	02/04/2012 03:46	TD
87-68-3	Hexachlorobutadiene	ND		ug/kg dry	76.9	192	1	EPA SW-846 8270C	02/03/2012 08:34	02/04/2012 03:46	TD
77-47-4	Hexachlorocyclopentadiene	ND		ug/kg dry	143	192	1	EPA SW-846 8270C	02/03/2012 08:34	02/04/2012 03:46	TD
67-72-1	Hexachloroethane	ND		ug/kg dry	69.1	192	1	EPA SW-846 8270C	02/03/2012 08:34	02/04/2012 03:46	TD
193-39-5	Indeno(1,2,3-cd)pyrene	ND		ug/kg dry	70.8	192	1	EPA SW-846 8270C	02/03/2012 08:34	02/04/2012 03:46	TD
78-59-1	Isophorone	ND		ug/kg dry	71.4	192	1	EPA SW-846 8270C	02/03/2012 08:34	02/04/2012 03:46	TD
91-20-3	Naphthalene	ND		ug/kg dry	57.4	192	1	EPA SW-846 8270C	02/03/2012 08:34	02/04/2012 03:46	TD
91-03-3	Nitrobenzene	ND		ug/kg dry	86.4	192	1	EPA SW-846 8270C	02/03/2012 08:34	02/04/2012 03:46	TD
62-75-9	N-Nitrosodimethylamine	ND		ug/kg dry	69.5	192	1	EPA SW-846 8270C	02/03/2012 08:34	02/04/2012 03:46	TD
621-64-7	N-nitroso-di-n-propylamine	ND		ug/kg dry	50.2	192	1	EPA SW-846 8270C	02/03/2012 08:34	02/04/2012 03:46	TD
86-30-6	N-Nitrosodiphenylamine	ND		ug/kg dry	111	192	1	EPA SW-846 8270C	02/03/2012 08:34	02/04/2012 03:46	TD
87-86-5	Pentachlorophenol	ND		ug/kg dry	53.8	192	1	EPA SW-846 8270C	02/03/2012 08:34	02/04/2012 03:46	TD
85-01-8	Phenanthrene	ND		ug/kg dry	70.9	192	1	EPA SW-846 8270C	02/03/2012 08:34	02/04/2012 03:46	TD
108-95-2	Phenol	ND		ug/kg dry	76.9	192	1	EPA SW-846 8270C	02/03/2012 08:34	02/04/2012 03:46	TD
129-00-0	Pyrene	ND		ug/kg dry	68.9	192	1	EPA SW-846 8270C	02/03/2012 08:34	02/04/2012 03:46	TD
110-86-1	Pyridine	ND		ug/kg dry	75.0	192	1	EPA SW-846 8270C	02/03/2012 08:34	02/04/2012 03:46	TD

YORK

ANALYTICAL LABORATORIES, INC.

Sample Information

Client Sample ID: 515W18-SB-8-8'-9'-Grab

York Sample ID: 12A0987-08

York Project (SDG) No.
12A0987

Client Project ID
515 West 18th St.

Matrix
Soil

Collection Date/Time
January 27, 2012 3:00 pm

Date Received
01/30/2012

Total Solids

Log-in Notes:

Sample Notes:

Sample Prepared by Method: % Solids Prep

CAS No.	Parameter	Result	Flag	Units	MDL	RL	Dilution	Reference Method	Date/Time Prepared	Date/Time Analyzed	Analyst
solids	% Solids	86.7		%	0.100	0.100	1	SM 2540G	02/03/2012 14:33	02/03/2012 14:33	JCC

YORK

ANALYTICAL LABORATORIES, INC.

Notes and Definitions

- 04 The surrogate recovery for this sample is outside of established control limits due to a sample matrix effect.
- S-01 The surrogate recovery for this sample may not be available due to sample dilution required from high analyte concentration and/or matrix interferences.
- QM-05 The spike recovery was outside acceptance limits for the MS and/or MSD due to matrix interference. The LCS and/or LCSD were within acceptance limits showing that the laboratory is in control and the data are acceptable.
- QL-02 This LCS analyte is outside Laboratory Recovery limits due the analyte behavior using the referenced method. The reference method has certain limitations with respect to analytes of this nature.
- J Detected below the Reporting Limit but greater than or equal to the Method Detection Limit (MDL); therefore, the result is an estimated concentration.
- B-Dil Detected in method blank(s) associated with the sample analysis. This is a common lab artifact which is found at ND-25 ppb. No dilution factor has been applied to these compounds to eliminate artificially inflated results.
- B Analyte is found in the associated analysis batch blank. For volatiles, methylene chloride and acetone are common lab contaminants. Data users should consider anything <10x the blank value as artifact.
-
- ND Analyte NOT DETECTED at the stated Reporting Limit (RL) or above.
- RL REPORTING LIMIT - the minimum reportable value based upon the lowest point in the analyte calibration curve.
- MDL METHOD DETECTION LIMIT - the minimum concentration that can be measured and reported with a 99% confidence that the concentration is greater than zero. If requested or required, a value reported below the RL and above the MDL is considered estimated and is noted with a "J" flag.
- NR Not reported
- RPD Relative Percent Difference
- et The data has been reported on an as-received (wet weight) basis
- Low Bias Low Bias flag indicates that the recovery of the flagged analyte is below the laboratory or regulatory lower control limit. The data user should take note that this analyte may be biased low but should evaluate multiple lines of evidence including the LCS and site-specific MS/MSD data to draw bias conclusions. In cases where no site-specific MS/MSD was requested, only the LCS data can be used to evaluate such bias.
- High Bias High Bias flag indicates that the recovery of the flagged analyte is above the laboratory or regulatory upper control limit. The data user should take note that this analyte may be biased high but should evaluate multiple lines of evidence including the LCS and site-specific MS/MSD data to draw bias conclusions. In cases where no site-specific MS/MSD was requested, only the LCS data can be used to evaluate such bias.
- Non-Dir. Non-dir. flag (Non-Directional Bias) indicates that the Relative Percent Difference (RPD) (a measure of precision) among the MS and MSD data is outside the laboratory or regulatory control limit. This alerts the data user where the MS and MSD are from site-specific samples that the RPD is high due to either non-homogeneous distribution of target analyte between the MS/MSD or indicates poor reproducibility for other reasons.

If EPA SW-846 method 8270 is included herein it is noted that the target compound N-nitrosodiphenylamine (NDPA) decomposes in the gas chromatographic inlet and cannot be separated from diphenylamine (DPA). These results could actually represent 100% DPA, 100% NDPA or some combination of the two. For this reason, York reports the combined result for n-nitrosodiphenylamine and diphenylamine for either of these compounds as a combined concentration as Diphenylamine.

Corrective Action:

120 RESEARCH DR. STRATFORD, CT 06615
(203) 325-1371 FAX (203) 357-0166

Field Chain-of-Custody Record

NOTE: York's Std. Terms & Conditions are listed on the back side of this document. This document serves as your written authorization to York to proceed with the analyses requested and your signature binds you to York's Std. Terms & Conditions unless superseded by written contract.

York Project No. 12A0987

Report To: Company: <u>COZE ENVIRONMENTAL</u> Address: <u>46-11 54th AVE</u> Phone No: <u>MASPETH NY 11378</u> Attention: <u>[Signature]</u> E-Mail Address: <u>[Signature]</u>		Report To: Company: <u>COZE ENVIRONMENTAL</u> Address: <u>46-11 54th AVE</u> Phone No: <u>MASPETH NY 11378</u> Attention: <u>[Signature]</u> E-Mail Address: <u>[Signature]</u>		Invoice To: Company: <u>SIS WEST</u> Address: <u>187th St</u> Phone No: <u>[Signature]</u> Attention: <u>[Signature]</u> E-Mail Address: <u>[Signature]</u>		YOUR Project ID Purchase Order No. <u>[Signature]</u>		Turn-Around Time RUSH - Same Day <input type="checkbox"/> RUSH - Next Day <input type="checkbox"/> RUSH - Two Day <input type="checkbox"/> RUSH - Three Day <input type="checkbox"/> RUSH - Four Day <input type="checkbox"/> Standard(5-7 Days) <input checked="" type="checkbox"/>		Report Type/Deliverables Summary Report <input checked="" type="checkbox"/> Summary w/ QA Summary <input type="checkbox"/> CT RCP Package <input type="checkbox"/> NY ASP A Package <input type="checkbox"/> NY ASP B Package <input type="checkbox"/> Electronic Deliverables: <input type="checkbox"/> EDD (Specify Type) <input type="checkbox"/> Excel <input type="checkbox"/>	
---	--	---	--	---	--	---	--	---	--	--	--

Print Clearly and Legibly. All Information must be complete. Samples will NOT be logged in and the turn-around time clock will not begin until any questions by York are resolved.

Samples Collected/Authorized By (Signature) [Signature]
Name (printed) VLADIMIR ORTIZ

Matrix Codes	Volatiles	Semi-Volatiles	Metals	Misc. Org.	Full Lists	Common Miscellaneous Parameters	Special Instructions
S - soil Other - specify (oil, etc.)	TICS Site Spec. Nassau Co. Surftek Co. Ketones Oxygenates TCLP list TAGM list CT RCP list S24.2 Arom. only NDEP 50 Histog. only App. IX list SRLP (TCLP) SCLB list	6270 & 625 STARS list BN Only Acids Only PAH list TAGM list CT RCP list ICL list NDEP list Arom. only App. IX Chlordane SRLP (TCLP) SCLB list	RCRAS pp15 list TAL CT15 list TAGM list NDEP list Total Dissolved SRLP (TCLP) Inch. Metals LIST Below	TPH GRO TPH DRG CT EPH NY 310-13 TPH 1664 Air TO14-A Air TO15 Air-SIAMS Air VPH Air TCS Methane Helium	PH/Leak TCL Organics TAL Metals Full TCLP Full App. IX Full TO14-A Part 360/Asbestos Part 360/Asbestos Part 360/Asbestos NACRP/Lead NYSP/Lead TAGM Silica	Nitrate Nitrite TKN Tot. Nitrogen Ammonia-N Chloride Phosphate Tot. Phos. COD Cr&Greas FOG pH MBAS	Color Phenols Cyanide-f Cyanide-A BOD5 CBOD5 BOD28 COD TSS Oil/Greas FOG TDS TPH/664

Sample Identification	Date Sampled	Sample Matrix	Choose Analyses Needed from the Menu Above and Enter Below	Container Description(s)
S15W18-SB1-8-9-GRAB	1-23-12	S	Full List VOCs / SVOCs	(1) 8oz SAR
S15W18-SB2-8-9-GRAB	1-23-12	S	"	"
S15W18-SB3-6-7-5-GRAB	1-25-12	S	"	"
S15W18-SB4-7-8-GRAB	1-27-12	S	"	"
S15W18-SB5-9-9-5-GRAB	1-26-12	S	"	"
S15W18-SB6-10-10-5-GRAB	1-26-12	S	"	"
S15W18-SB7-7-8-GRAB	1-27-12	S	"	"
S15W18-SB8-8-9-GRAB	1-27-12	S	"	"

Preservation: Frozen, HCl, MeOH, HNO₃, NaOH
Check those Applicable: H₂O₂, Other

Comments: ANALYZE ALL SAMPLES FOR FULL LIST VOCs / SVOCs

Samples Relinquished By: [Signature] Date/Time: 1-30-12 1:30
Samples Received By: [Signature] Date/Time: 1/30/12 1545

Temperature on Receipt: 3.4 °C