

**REMEDIAL INVESTIGATION/FEASIBILITY STUDY  
APPENDICES A-F  
VOLNEY LANDFILL, TOWN OF VOLNEY,  
OSWEGO COUNTY, NEW YORK**



Prepared for :

**NEW YORK STATE  
DEPARTMENT OF ENVIRONMENTAL CONSERVATION**

50 Wolf Road, Albany, New York 12233

Henry G. Williams, Commissioner

**DIVISION OF SOLID AND HAZARDOUS WASTE**

Norman H. Nosenchuck, P.E. - Director

**URS Company, Inc.**

570 Delaware Avenue  
Buffalo, New York 14202

**MAY 1987**

APPENDIX A  
Surface Geophysical Studies



**DUNN**  
GEOSCIENCE CORP.

May 14, 1986

5 NORTHWAY LANE NORTH •  
LATHAM, NEW YORK 12110  
(518) 783-8102

Mr. Daniel W. Rothman, P.E.  
URS Company, Inc.  
625 Delaware Avenue  
Buffalo, New York 14202

RE: Summary of Geophysical Findings, Volney Landfill  
Oswego County, New York  
DGC Project Number 553-3-4337

Dear Mr. Rothman:

This letter report and accompanying figures summarize results of surface geophysical investigations conducted by Dunn Geoscience Corporation (DGC) at the Volney (Oswego Valley) Landfill, September 25-26, 30, October 1-4, 7-11, 1985, as part of the RI/FS. Also included in this report are recommendations based on onsite observations and the geophysical results, for modifying or refining the proposed drilling activities described in the September, 1985, Investigation Work Plan.

#### INTRODUCTION

The Volney Landfill is a closed 85-acre County facility located approximately four miles northeast of the City of Fulton in the Town of Volney, Oswego County, New York. The landfill is described in the engineering closure report (Barton and Loguidice, 1984). Approximately 55 acres of the site have been landfilled. The southern half of the site was the first part to be landfilled, utilizing an existing gravel pit. Other abandoned gravel pits are located to the east and the south of this area. The central and northern parts of the landfill were

utilized after excavating the surficial sand and gravel and grading the underlying glacial till toward a leachate collection system. Closure operations by others, including capping of the landfill with a geomembrane and soil, were underway during the geophysical field investigation.

Geophysical traverses were completed along the landfill perimeter and along accessible radial lines directed outward from the landfill (see Plates 1 and 2). Traverses were relocated, as necessary, from locations proposed in the September 1985 work plan to minimize accessibility problems and local interference effects. Site access limitations include steep slopes in excavated areas, airport boundaries, and thick woods. Local sources of interference include overhead powerlines, fence lines, traffic and heavy machinery vibrations, landfill refuse, and utility lines. Traverses located to the south of the landfill were conducted along the south side of Howard Road in grassy and brushy fields, and in an abandoned sand and gravel pit. Traverses to the west and north were conducted in woods, sand borrow areas, overgrown apple orchards, and across the toe of the landfill. Traverses to the east were conducted along the east edge of Silk Road and in an abandoned sand and gravel pit between Bell Creek and Silk Road.

Prior to conducting geophysical surveys, alphanumerically labeled reference stakes were established along traverse lines at 150-foot intervals by URS and DGC. Locations of these traverse lines are shown on Plates 1 and 2. All geophysical survey stations refer to this station designation system.

Geophysical survey techniques employed at the Volney Landfill consisted of terrain conductivity (TC) profiling, electrical resistivity sounding, and seismic refraction surveying. The terrain conductivity profiling was performed along the perimeter

of the site in order to provide information on lateral variations in shallow stratigraphy and groundwater. This preliminary information can be used to help evaluate and modify the proposed monitoring well program and interpolate subsurface conditions between or extrapolate beyond completed boreholes. An electrical resistivity sounding was performed along the TC traverse to determine the general variations in subsurface electrical properties with depth and thereby facilitate interpretation of the TC data.

The seismic refraction surveying was performed along the landfill perimeter and along eight radial lines directed away from the landfill to determine overburden stratigraphy and depth to bedrock. This preliminary information can be used to help evaluate and modify the proposed drilling program and interpolate subsurface conditions between, or extrapolate beyond, completed borings.

#### TERRAIN CONDUCTIVITY PROFILING

##### Description of Survey

Terrain conductivity (TC) measurements were made around the landfill perimeter using Geonics EM-31 and EM-34-3 terrain conductivity meters. Traverse locations are shown on Plate 1. The two different instruments were used to explore to different depths. The EM-31 was operated in its standard mode, investigating to a typical maximum depth of approximately 20 feet. Stations were spaced 25 feet apart. The EM-34 was operated with a 20-meter intercoil spacing in both the horizontal dipole mode, investigating to a maximum depth of approximately 50 feet, and in a vertical dipole mode, investigating to a maximum depth of approximately 100 feet. EM-34 stations were spaced 50 feet apart.

The TC survey was conducted in general accordance with the work plan, except additional EM-31 traverses were completed along the east, north and northwest portions of the landfill to further define near-surface characteristics in areas of particular interest identified during the field survey. Also, EM-34 vertical dipole mode measurements were deleted along the south and east perimeters due to suspected interference from the relatively nearby fence, powerlines and landfill.

The TC profiles are presented in Figures 1 through 4, proceeding in a counterclockwise direction around the landfill starting with the south perimeter (Figure 1). For the east (Figure 2A and 2B) and north (Figure 3A and 3B) perimeters, the profiles were offset and segmented to accommodate site conditions and provide adequate lateral coverage.

The figures include both the EM-31 and EM-34 data profiles superimposed on a common set of axes to facilitate visual comparisons. This method of presentation illustrates the station by station differences of the EM-31 and EM-34 TC values.

#### Results and Discussion

The terrain conductivity profiles indicate substantial lateral variation around the landfill perimeter. Many of these variations can be attributed to changes in subsurface materials, the depth to the watertable or apparent groundwater contamination. The following dicussion summarizes the major variations observed on each leg of the perimeter survey and compares the data with site reconnaissance observations and existing boring and water-quality data. The alternative interpretations are subject to confirmation and refinement by future drilling and monitoring well data.

In general, terrain conductivities appear to increase with depth. This is due to the presence of the water table and glacial till which are more conductive than the overlying, unsaturated sand and gravel. In many areas the depth of investigation of the EM-31 was shallower than the water table and therefore, could not detect groundwater. Additional discussion of the depth of investigation for these instruments is presented in the discussion of the electrical resistivity survey.

#### South Perimeter

The terrain conductivity profiles for the south perimeter, S-S', are shown on Figure 1. The profile indicates three anomalies of interest: very low conductivities east of station 2+00, a break in the pattern at station 11+00, and a zone of high conductivity from stations 17+00 to 20+00. Based on the log for Well No.8 the very low conductivities east of station 2+00 are attributed to a relatively deep water table and thick sequence of sand and gravel that may correspond with wave delta gravels mapped in this area. Low conductivities observed at the profile E-E' (Figure 2)

#### APPENDICES

- A - Surface Geophysical Study Report
- B - Soil Boring Logs
- C - Rock Core Logs
- D - Monitoring Well Installation Reports
- E - Property Results of Soil Samples

unsaturated surficial deposits, is relatively thin in this area, thereby suggesting that the cause of the TC anomaly is stratigraphic rather than groundwater quality-related.

The high conductivity anomaly from stations 17+00 to 20+00 in the western part of the profile may be attributed to the combined effect of a buried steel pipeline, shallow water table, soil texture change, and groundwater contaminants which were detected in monitoring well No. 3. The sharpness of the EM-31 anomaly suggests that conductive materials are relatively shallow. This anomaly is probably associated with the high conductivities observed nearby at the south end of profile W-W' (see Figure 4). The seismic data show a thickening of layer 1 deposits in this area for seismic lines S and W.

#### East Perimeter

Terrain conductivity profiles along the east perimeter are shown in Figures 2A (traverse E-E') and 2B (traverse EE-EE'). The predominant anomaly observed on traverse E-E' is the high conductivity zone between stations 26+00 and 36+00, possibly indirectly related to a topographic swale and the close proximity of the landfill. This anomaly appears to be sharpest in the EM-31 data suggesting a relatively shallow source. It should be noted that existing monitoring well no. 9 is at the south end of the anomaly and existing well no. 5 is in the central portion, but no groundwater quality data was available for these wells at the time of data analysis. The seismic data for this area show a gradual thinning of layer 1 toward the north. This may be partly caused by a change in the stratigraphy or water table depth.



The anomalous zone is abruptly bounded to the north by a creek. A similar situation of relatively higher conductivities on the south side of the creek is also observed in profile N3-N3' (see Figure 3B). This suggests that soil textures, the depth to the water table, or most likely, the degree of groundwater contamination may differ north and south of the creek. Subsurface conditions south of the creek may consist of fine-grained relatively conductive soil, a shallower water table, contaminated groundwater or a combination of these conditions. The creek may act as a hydrologic flow boundary intercepting to some degree, contaminated groundwater flowing from the landfill. The presence of contaminated groundwater underlying other portions of line E-E' may be undetected because of the deep water table and surface interference effects.

Traverse EE-EE', (Figure 2B) was conducted with the EM-31 in an abandoned sand and gravel pit, which is 40 to 50 foot lower in elevation than the terrain along E-E'. Traverse EE-EE' was completed in the gravel pit to avoid interference effects along Silk Road and to get closer to the water table to enhance the signature of possible contaminant plumes.

The relatively high conductivity values observed south of 2+00 on profile EE-EE' (Figure 2B) are attributed to the shallow water table. One area of particular interest may be the terrain conductivity contrast between stations 4+00 and 7+00. The cause of this anomaly is uncertain, but may be related to soil texture or groundwater quality changes and could be investigated further with monitoring wells. The relatively high conductivity in the vicinity of station 10+00 is probably caused in part by the marshy conditions at this location.

### North Perimeter

Terrain conductivity profiles for the north perimeter are shown on Figures 3A and 3B. Figure 3A shows traverse, N-N', which crossed directly over the landfill debris. Figure 3B presents several traverses, N1-N1', N2-N2', and N3-N3', which were conducted north of N-N' to avoid the landfill debris and investigate particular areas of interest.

Profile 'N-N' shows three terrain conductivity patterns associated with conspicuous surface features. The variable and high terrain conductivities from station 0+00 to 7+00 are attributed to the conductive landfill debris and are not diagnostic of subsurface conditions. Relatively uniform values from station 7+00 to 9+00 are associated with the sand and gravel borrow area adjacent to the landfill. Field observations suggest that till may be very close to the ground surface in this area. The very low conductivities west of station 9+00 are associated with the undisturbed soils in the orchard area and are probably indicative of unsaturated sand and gravel. Seismic refraction results, discussed later, support this interpretation and indicate that a surficial sand and gravel layer, approximately 15 to 20 feet thick extends west of the cut slope near station 10+00.

Profile N1-N1' on Figure 3B was conducted in the woods north of N-N' and indicates a conductivity high at the east end near station 0+00. This anomaly is probably associated with the nearby high conductivity anomaly observed at the north end of profile E-E' and may be caused by a shallow, conductive contaminant plume originating in the northeast corner of the landfill. The high conductivity zone at the west and northwest

end of N1-N1' is attributed to the presence of saturated, marshy soil conditions, and possibly to a near-surface soil change. Based on the TC data, it is uncertain if the water in this area is contaminated. The seismic data indicate a relatively high layer 1 velocity of 2045 fps in this area probably caused by the wet soil conditions.

Profile N2-N2' is a connecting leg between N-N' and N1-N1'. It shows the effect on TC of increased soil moisture at the northeast end of this profile in contrast to the relatively drier and topographically higher borrow area to the southwest.

Profile N3-N3' shows the results of a traverse conducted across the creek located north of the landfill. The purpose of this traverse was to investigate terrain conductivities on the south and north side of the creek as follow up to anomalies observed on profile E-E'. The data indicate slightly higher conductivities on the south side adjacent to the landfill. This may be attributed to a soil change, to a slightly higher water table or to contaminated groundwater on the landfill side of the creek, as discussed for the east perimeter.

#### West Perimeter

The terrain conductivity profiles for the west perimeter are shown on Figure 4. Very low conductivities, on the order of 1 millimho per meter for the EM-31, were observed at the north end of this line and are attributed to the presence of at least 15 feet of unsaturated sand and gravel in the woods north-northwest of the borrow area. This interpretation suggests a soil stratigraphy similar to the nearby west end of profile N-N'.

The increase in EM-31 conductivity south of station 5+00 occurs at the north edge of the borrow excavation area and is likely caused by a shallower water table and decreased thickness of sand and gravel overlying till. The relatively uniform EM-34 measurements in these areas suggest that deeper subsurface conditions are laterally uniform.

An abrupt increase in TC magnitude and variability south of station 13+00 is attributed to the nearby presence of conductive fill and possibly contaminated groundwater because stressed vegetation is evident in the area. Stratigraphic and water table variations could also contribute to the elevated conductivity. The high EM-34 (vertical dipole) conductivities south of station 13+00, up to 84 millimhos per meter, are attributed to the presence of conductive contaminants or to the lateral detection of nearby, very conductive fill and/or leachate.

#### ELECTRICAL RESISTIVITY

##### Description of Survey

A single resistivity sounding was conducted at station 9+00 along lines S (Plate 1). Field procedures were in accordance with the work plan. The sounding was performed using the Wenner array with electrode spacings ranging progressively from 0.5 feet to 300 feet. The apparent resistivities for each electrode spacing were calculated and plotted in the field to identify and eliminate spurious data points insofar as practicable. The sounding curve is shown in Figure 5. As a further quality control check to identify undesirable lateral variations, measurements were taken with the Lee electrode

configuration whereby left and right components of each resistivity sounding measurement are evaluated. Analysis was by computer and consisted of developing and interpreting a Barnes Layer model.

#### Results and Discussion

The Barnes Layer model, based on the assumption that the electrode spacing is equal to the depth of investigation, is shown in Figure 6. The five geo-electric layers shown on Figure 6 are interpreted from the model. Based on the available subsurface information, the layers are tentatively classified as follows, subject to confirmation and refinement by future drilling data. Layer one is interpreted to consist of approximately 0.5 feet of loose, dry relatively resistive surface soil. Layer two is interpreted to consist of approximately 3.5 feet of relatively conductive moist topsoil or silty soil. Layer three is interpreted to consist of 6.0 feet of dry to moist sand and gravel. Layer four is the predominant layer and is interpreted to consist of till. Layer five at a depth of approximately 90 feet probably consists of bedrock. The relatively low apparent resistivity of the bedrock was unexpected and may suggest that the bedrock is relatively wet, porous and pervious in comparison to the overlying till. Alternately, groundwater in the bedrock may have a higher electrolyte concentration than the till or the low resistivities observed may be a lateral effect caused by the nearby landfill, fencing or powerlines.

The resistivity interpretation is in good agreement with the seismic data, which suggests the presence of an upper soil layer from 0 to 12 feet deep and a dense layer, probably till, from 12

to 90 feet deep overlying bedrock. Corroboration of the independent resistivity and seismic data strengthens the reliability of the individual geophysical interpretations and suggests that lateral resistivity interference effects may be minor.

The multilayered geo-electric model interpreted from the resistivity sounding suggests that it is not feasible to convert the terrain conductivity measurements directly into depth estimates for the till or water table around the landfill perimeter. However, qualitative estimates may be possible. A comparison of observed resistivities and terrain conductivities at station 9+00 indicates the EM-31 measurements at this location respond primarily to the upper 10 feet of soil which is sandy and unsaturated, whereas the EM-34 responds primarily to greater depths, i.e. the saturated zone and till.

#### SEISMIC REFRACTION SURVEY

##### Description of Survey

The seismic refraction survey consisted of 50 individual seismic spreads arranged along traverse lines shown on Plate 2. Of these 50 spreads, 48 were 300 feet long and 2 were 100 feet long. The 300-foot spreads provided bedrock topography and the seismic stratigraphy of overburden materials. The 100-foot spreads provided verification of overburden seismic velocities. Spreads were arranged in 4 perimeter lines surrounding the landfill and 5 radial lines extending out from the landfill vicinity. Where possible, perimeter lines were extended beyond the landfill to provide additional radial coverage.

Data were collected in accordance with the Work Plan using a 12 channel seismograph with a "Betsy" seisgun energy source. Geophones were spaced 15 and 30 feet apart for the 300-foot spreads and 5 and 10 feet apart for the 100-foot spreads. Generally, five shot points were used for each of the 300-foot spreads, although accessibility limitations occasionally resulted in omitting one of the offset shots.

Data analysis and interpretation were facilitated using a modified computer program originally developed by the U.S. Bureau of Mines. Travel times of first seismic arrivals were manually measured from the seismic records and travel-time curves were plotted. The travel-time data and corresponding layers were then entered into the computer. An initial program run was conducted to calculate velocities of seismic layers and to check the data. Velocities originally assigned to layers were then modified according to the calculated velocities and the program was re-run to produce a printout of the refined seismic profile. The results of individual line segments were then compiled onto Plates 3, 4, and 5.

#### Results and Discussion

Seismic sections along the landfill perimeter and radial lines are shown in Plates 3, 4, and 5. These sections show elevations of the ground surface, interpreted seismic stratigraphic contacts and calculated velocities for each layer. Intersection points for crossing profiles are also shown.

The sections indicate the presence of three layers. Interpreted seismic velocities, depths, elevations and thicknesses for each layer are summarized on Table 1. Based on the site geologic data and descriptions provided by URS and typical published seismic velocities, the layers are tentatively classified as follows, subject to confirmation and refinement by drilling data.

Layer 1, in most of the survey area, consists of a relatively loose deposit with velocities ranging from 750 to 2000 feet per second (fps). This layer is interpreted to include topsoil and unsaturated weathered silt, sand, and gravel materials deposited during deglaciation of the region. For part of the seismic survey area, layer 1 consists of a more compact deposit, with velocities ranging from about 2000 to 3500 fps. These higher layer 1 velocities were measured at the northwest side of the landfill, in an area where the surficial layer of sand and gravel was excavated down to the underlying denser glacial till. Layer 1 is interpreted to include the weathered top few feet of glacial till in these areas.

Layer 1 thickness is generally in the range of 5 to 15 feet for most of the survey area. Layer 1 is thinnest in areas which have been previously excavated for sand and gravel materials, such as along lines EE, SRC, and parts of lines W, S, N1 and N2. The seismic profile of line N3 (Plate 3) clearly shows the cut bank of sand and gravel at station 10+00. East of this point, Layer 1 is very thin due to excavation. The layer 1



thickness indicates that the sand and gravel unit extends to the west for at least 500 feet, with a thickness of about 10 to 15 feet. Thicker sections of layer 1 materials (20 feet or more) are noted at the south end line W and along several sections of lines E and EA.

Layer 2 is a denser deposit with highly variable seismic velocities ranging from approximately 3600 fps to 8300 fps. The high variability suggests that lateral changes in soil types are present. The lower velocities of 3600 to about 6000 fps were observed along all of the east perimeter lines (Lines E, EE, EEA, and EA) with the exception of the southernmost 300-foot spread (Line E, stations 0+00 to 3+00). Lower velocities were also observed in a few other spreads, including lines N1 (stations 3+00 to 6+00), WRB (stations 3+00 to 6+00), and S (stations 0+00 to 3+00 and 18+00 to 21+00). The remainder of the spreads had layer 2 velocities greater than 6000 fps.

The higher velocity layer 2 materials are interpreted to be possibly dense or bouldery lodgement till. The lower velocity layer 2 materials are interpreted to be less dense materials, possibly sand and gravel deposits. It is possible that the layer 2 velocities are composite velocities of both sand and gravel deposits and lodgement till deposits. If this is the case, then the areas with lower velocities are probably areas with more sand and gravel than till while the areas with higher velocities are probably more till than sand and gravel. The thickness of layer 2 materials ranges from 24 feet to 90 feet across the entire site area.

Layer 3 is probably bedrock with velocities ranging from about 10,000 to 20,000 fps. This wide range of bedrock velocities is probably attributable to factors such as the variable and, in places, great depth to rock, the presence of dense and bouldery lodgement till overlying bedrock, and variable degrees of

weathering and fracturing in the bedrock. The bedrock surface varies from 36 to 100 feet deep and appears to be somewhat irregular and hummocky. The interpreted bedrock surface ranges in elevation from 354 to 440 feet. Bedrock lows are found in the quarry east of Silk Road (Lines EE and EEA) and along Howard Road (Line S) near the south end of Line W. Bedrock is generally higher at the north end of the site, at the southeast corner of the site (junction of lines S and E) and at line W, station 15+00.

#### RECOMMENDATIONS FOR FINAL DRILLING PLAN

The findings of the geophysical investigations, discussed above, along with logs of previously drilled wells provide a technical basis for selection of final drilling locations and number of wells at each location. Locations and numbers of wells were adjusted to provide adequate soil and groundwater samples in areas of anomalous terrain conductivity and to provide a better distribution of monitoring wells among different stratigraphic units. Areas of possible groundwater contamination and areas with thicker sand and gravel units were of particular interest. Additionally, site access limitations caused by factors such as vegetation, topography, fences, and overhead electric lines were taken into consideration.

Changes from the monitoring well plans outlined in the work plan are primarily changes in three-well clusters from one location to another. Due to anticipated distribution of sand and gravel materials, three-well clusters are changed from location BW-17 to BW-8, from BW-16 to BW-3 and from BW-11 to BW-10. This distribution also provides bedrock well locations which form a nearly equilateral triangle close to the margins of the landfill. Other changes in well locations are described below.

- BW-1: Move from under power lines, across Howard Road, farther from edge of road than previous wells. A deep water table is anticipated on the basis of terrain conductivity, so change to single well. Move second well to location BW-3.
- BW-2: Move slightly west on Howard Road to provide better perimeter coverage (with BW-12).
- BW-3: Move very slightly west to open area of former house. Change to four-well cluster due to thick sand and gravel, combining wells taken from sites BW-1 and BW-16.
- BW-4: No location change. Change to well pair, using second well from site BW-5, due to deeper sand and gravel.
- BW-5: Move slightly west. Change to single well, moving second well to BW-4.
- BW-6: Move slightly north, out of traffic area.
- BW-7: Relocate slightly to a location near Silk Road (area of higher terrain conductivity).
- BW-8: No location change. Change to three-well cluster, moving second and third wells from BW-17, due to deeper sand and gravel.
- BW-9: Move very slightly, out of traffic area.
- BW-10: Move from under power lines to inside landfill fence. Change to three-well cluster, moving second and third wells from BW-11, to provide near-landfill cluster.

- BW-11: Move south down Silk Road to provide radial coverage. Move second and third wells to BW-10.
- BW-12 Move slightly east on Howard Road to provide better perimeter coverage (with BW-2).
- BW-13: Move south, near house on Howard Road.
- BW-14: Move across Silk Road to high terrain conductivity area.
- BW-15: No change.
- BW-16: Move south to Niagara Mohawk garage area. Move second and third wells to BW-3.
- BW-17: Move slightly to location on road in woods. Move second and third wells to BW-8.

This concludes our summary of geophysical investigations, Work Plan Section 7.3.3, at the Volney Landfill Site. If you have any questions or comments, please contact us.

Very truly yours,  
DUNN GEOSCIENCE CORPORATION

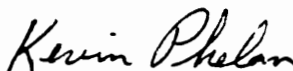

Kevin Phelan  
Hydrologist

KP/cf

Enclosures:  
Table 1  
Figures 1 through 6  
Plates 1 through 5

TABLE 1

Summary of Seismic Interpretations  
 Volney Landfill  
 URS Company, Inc.

<u>Seismic Section</u>	<u>Layer</u>	<u>Velocity fps</u>	<u>Depth to Top of Layer, ft</u>	<u>Elev. of Top of Layer, ft</u>	<u>Thickness of Layer, ft</u>
North A	1	1713 to 2045	-0-	452	2 to 14
	2	5537 to 6015	2 to 14	438 to 450	26 to 48
	3	12716 to 13060	36 to 52	400 to 416	--
North B	1	1954	-0-	452 to 458	2 to 14
	2	7021	2 to 14	438 to 453	25 to 38
	3	11662	37 to 46	406 to 420	--
North C	1	1181 to 1202	-0-	460 to 476	4 to 16
	2	6864 to 8263	4 to 16	456 to 464	30 to 48
	3	11681 to 11958	36 to 60	414 to 426	--
West	1	1011 to 3418	-0-	466 to 486	4 to 32
	2	6116 to 8053	2 to 14	458 to 480	42 to 72
	3	10139 to 22791	52 to 92	388 to 430	--
West Radial A	1	1225 to 2392	-0-	468 to 476	4 to 16
	2	7022 to 7528	4 to 16	456 to 470	52 to 74
	3	12570 to 15780	60 to 82	392 to 414	--

TABLE 1 (Cont'd.)

Summary of Seismic Interpretations  
 Volney Landfill  
 URS Company, Inc.

<u>Seismic Section</u>	<u>Layer</u>	<u>Velocity fps</u>	<u>Depth to Top of Layer, ft</u>	<u>Elev. of Top of Layer, ft</u>	<u>Thickness of Layer, ft</u>
West Radial B	1	1135 to 1336	-0-	472 to 480	6 to 12
	2	5987 to 6191	6 to 12	462 to 472	40 to 60
	3	11480 to 13482	48 to 66	406 to 424	--
South	1	782 to 1243	-0-	464 to 497	6 to 18
	2	5519 to 7818	6 to 18	454 to 486	39 to 90
	3	10792 to 19540	52 to 100	376 to 440	--
South Radial A	1	1121 to 1830	-0-	468 to 474	2 to 16
	2	6881 to 7560	2 to 16	456 to 466	44 to 72
	3	11204 to 17957	46 to 86	384 to 422	--
South Radial B	1	1152 to 1180	-0-	470 to 480	4 to 14
	2	6115 to 6231	4 to 14	458 to 466	41 to 84
	3	12088 to 14200	40 to 95	380 to 420	--
South Radial C	1	1295 to 1518	-0-	480 to 496	4 to 16
	2	7175 to 7662	4 to 16	470 to 482	60 to 82
	3	12131 to 14363	70 to 92	388 to 420	--

TABLE 1 (Cont'd.)

Summary of Seismic Interpretations  
 Volney Landfill  
 URS Company, Inc.

<u>Seismic Section</u>	<u>Layer</u>	<u>Velocity fps</u>	<u>Depth to Top of Layer, ft</u>	<u>Elev. of Top of Layer, ft</u>	<u>Thickness of Layer, ft</u>
East (0+00 to 15+00)	1	1084 to 1619	-0-	488 to 496	12 to 32
	2	3655 to 6274	12 to 32	460 to 484	31 to 65
	3	9859 to 18669	52 to 94	395 to 437	--
East Quarry (Offset east)	1	1043 to 1414	-0-	442 to 460	2 to 16
	2	4337 to 5115	2 to 16	436 to 444	40 to 85
	3	12923 to 18893	56 to 87	354 to 404	--
East (24+00 to 36+00)	1	1040 to 1128	-0-	452 to 478	4 to 26
	2	5043 to 5379	4 to 26	442 to 452	24 to 50
	3	10670 to 12448	30 to 72	396 to 424	--

# TC PROFILE S-S'

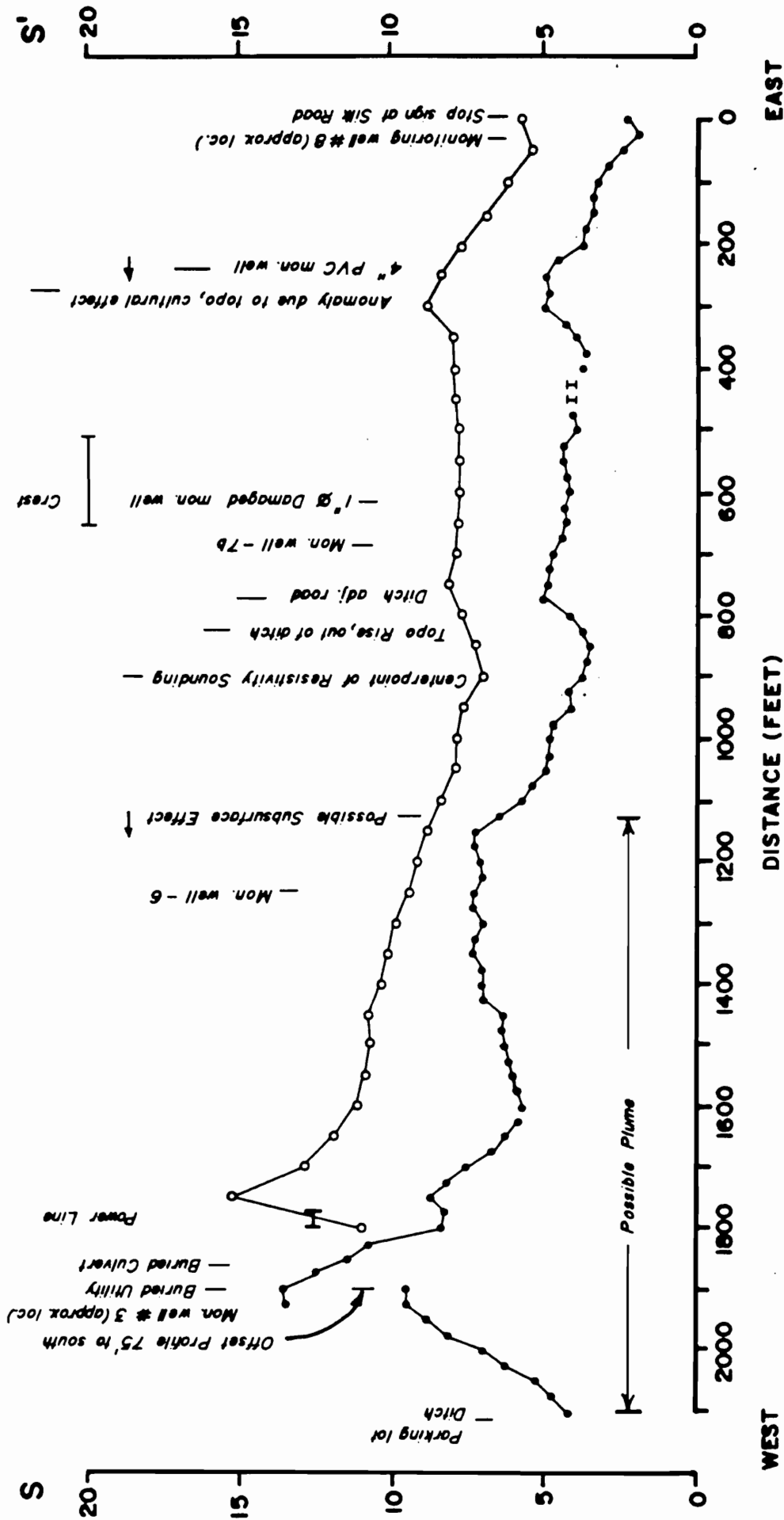

**VOLNEY  
LANDFILL  
URS COMPANY,  
INC.**

**FIGURE 1**

**NOTES:**  
EM-34 Vertical dipole survey  
not conducted due to interference.

- LEGEND:**
- EM-31 Measurement
  - EM-34, 20 meter intercoil spacing, horizontal dipole
  - I Interference



TC PROFILE EE-EE'

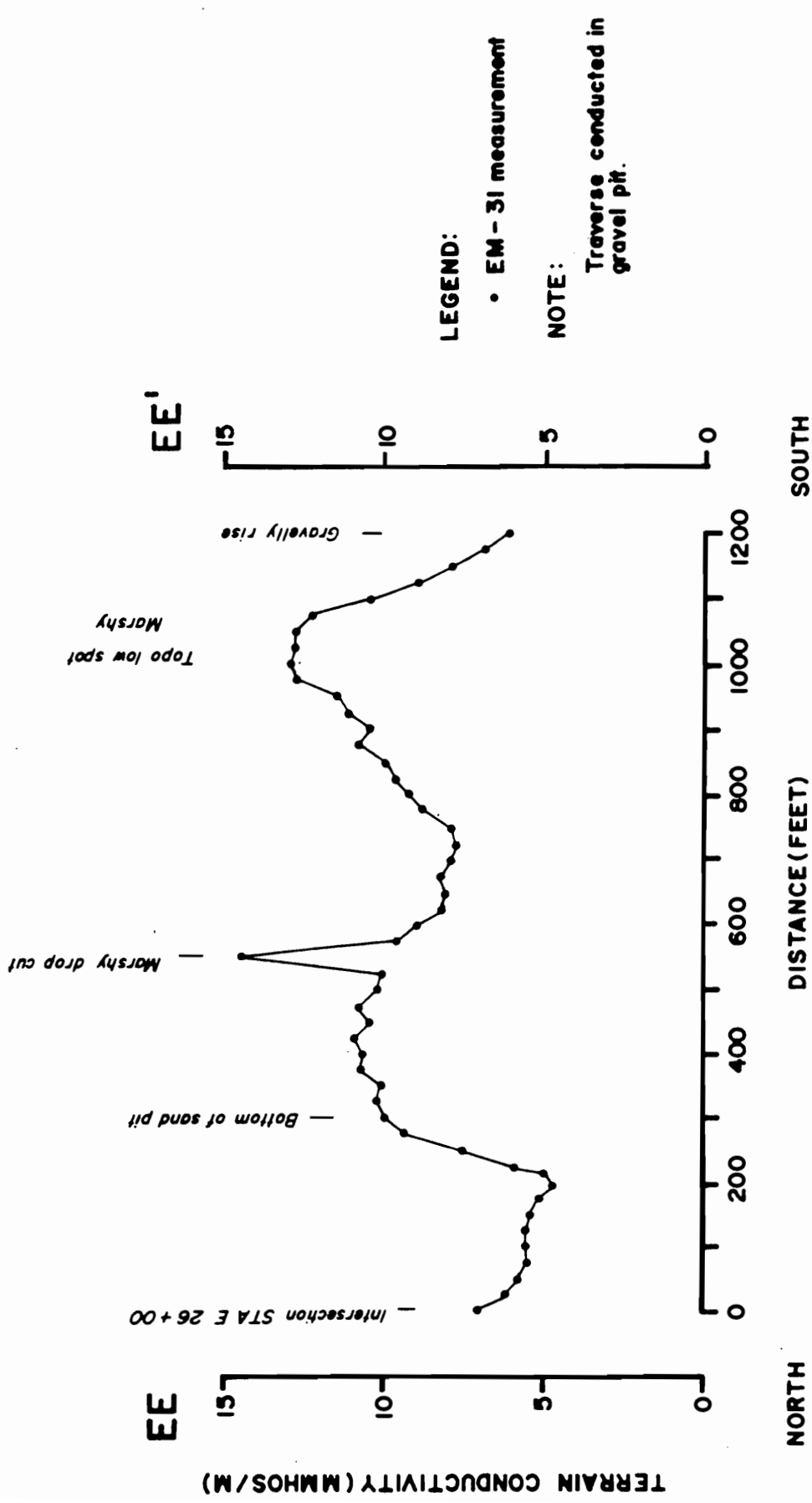

VOLNEY LANDFILL  
URS COMPANY, INC.

FIGURE 2B

TC PROFILE N-N'

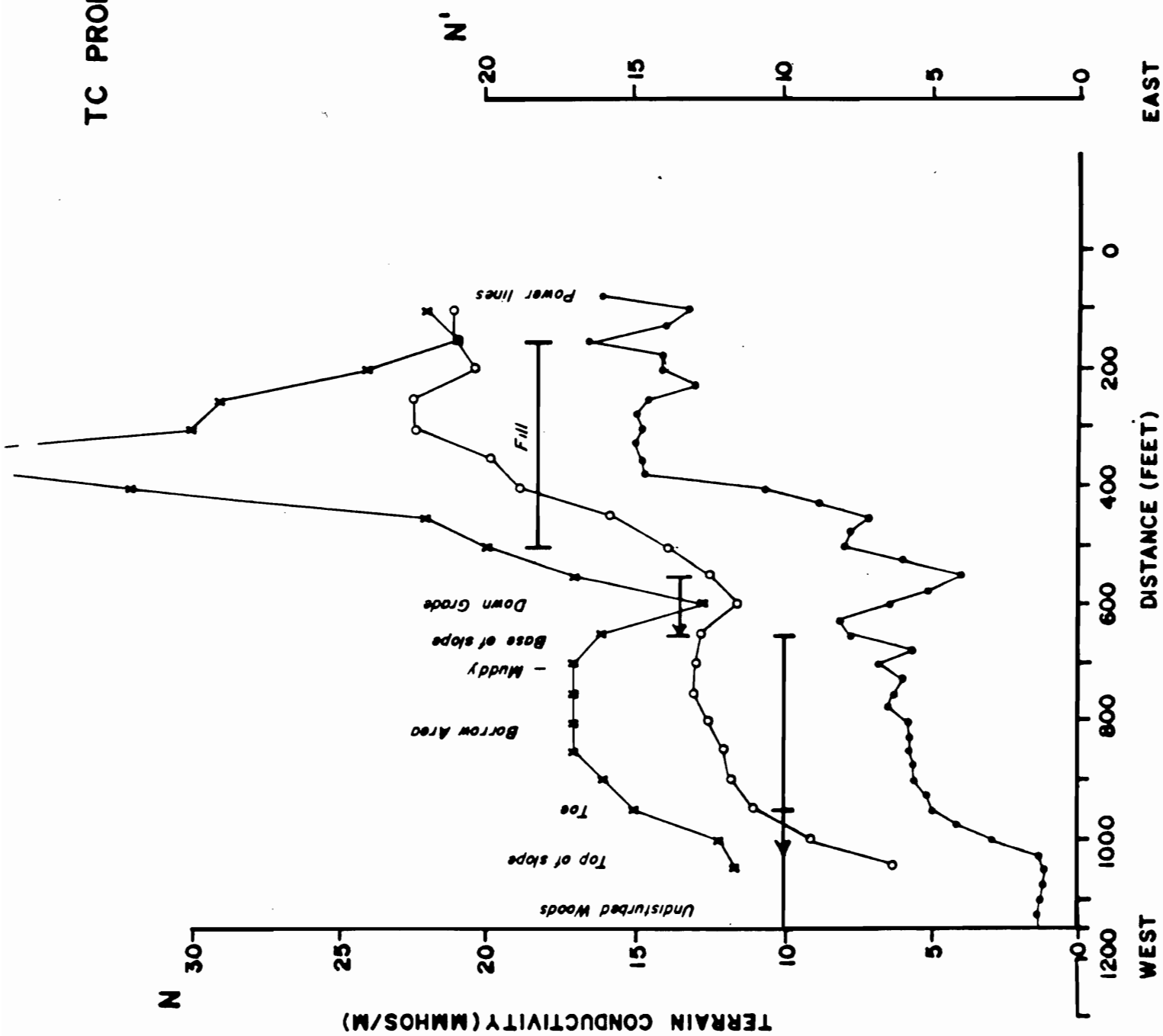

LEGEND:

- EM - 31
- EM - 34, 20 m intercoil spacing, horizontal dipole
- x EM - 34, 20 m intercoil spacing, vertical dipole

VOLNEY LANDFILL  
URS COMPANY, INC.

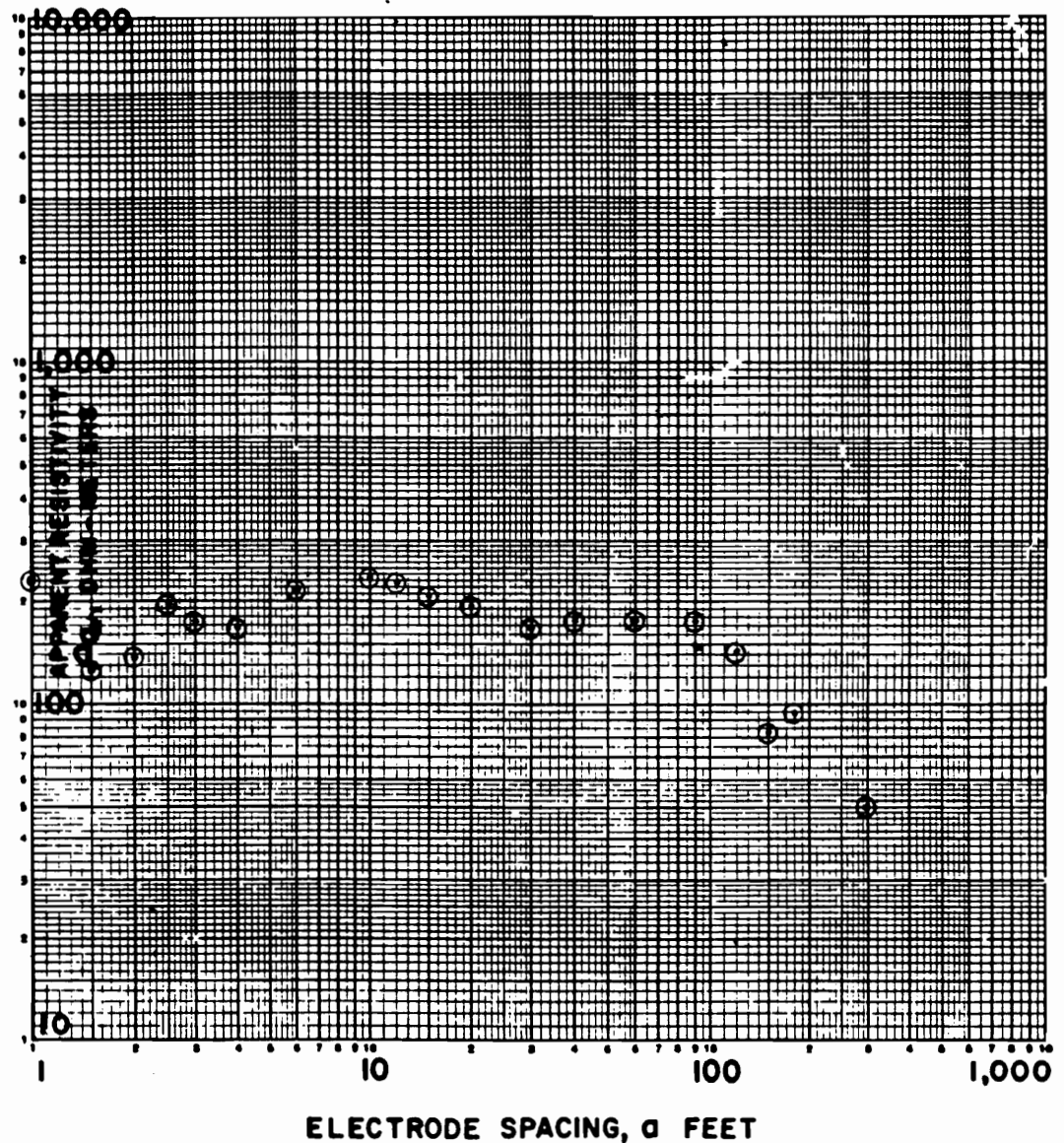

FIGURE 3A



PROJECT Volney Landfill SOUNDING NO. 1  
CLIENT URS Engineers DATE 9/25/85

### ELECTRICAL RESISTIVITY SOUNDING WENNER ARRAY



#### NOTES

1. Apparent resistivity at  $a = 0.5$  ft. is 904.5 ohm-meters, not shown.
2. Centerpoint was located at station 9+00 along line S.

**FIGURE 5**  
**RESISTIVITY SOUNDING**  
**VOLNEY LANDFILL**

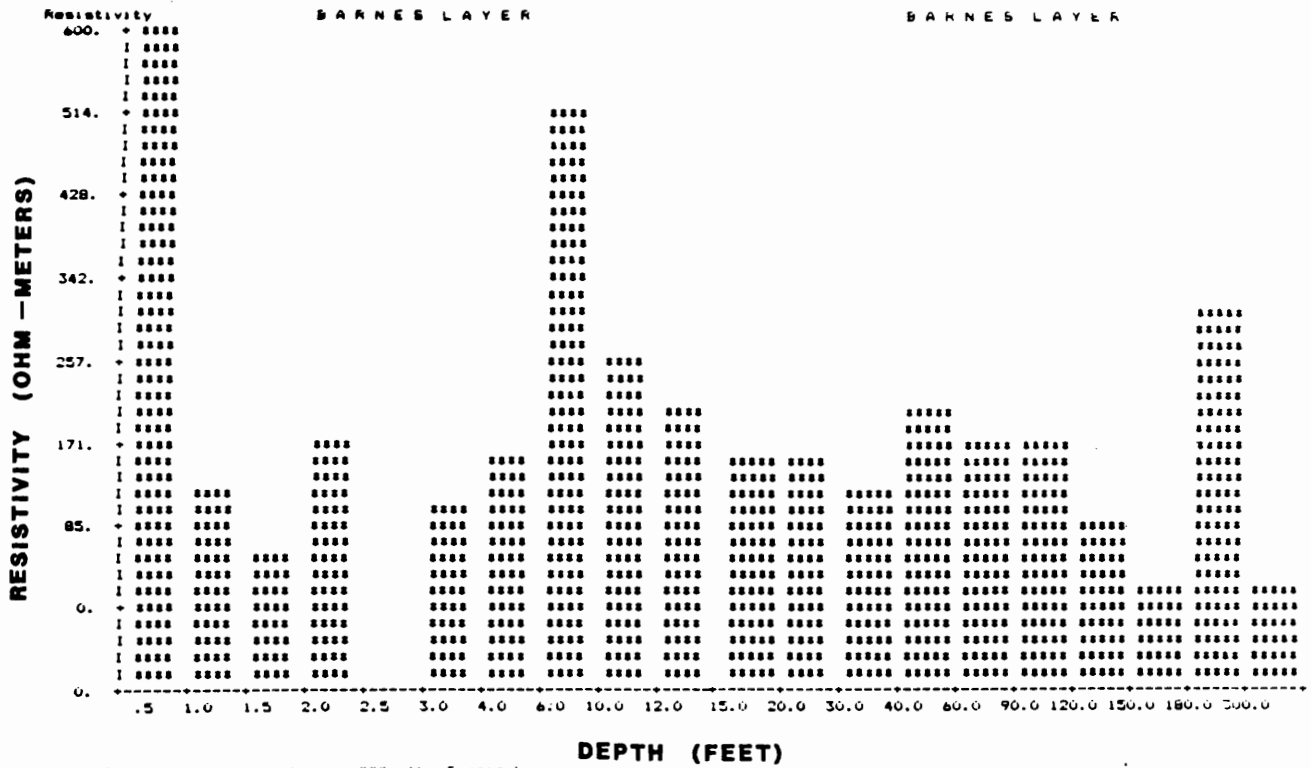

NOTE: If a column is printed in "0", the Barnes Layer resistivity approaches infinity.

#### Simplified Model

<u>Layer</u>	<u>Depth, Ft.</u>	<u>Barnes Layer Resistivity</u>
1	0'-0.5'	900
2	0.5'-4.0'	100
3	4.0'-10.0'	250
4	10.0'-90.0'	175
5	90.0'+	50

**FIGURE 6**  
**BARNES LAYER MODEL**  
**VOLNEY LANDFILL**  
**URS COMPANY, INC.**

1  
2  
3  
4  
5  
6  
7  
8  
9  
10  
11  
12  
13  
14  
15  
16  
17  
18  
19  
20  
21  
22  
23  
24  
25  
26  
27  
28  
29  
30  
31  
32  
33  
34  
35  
36  
37  
38  
39  
40  
41  
42  
43  
44  
45  
46  
47  
48  
49  
50  
51  
52  
53  
54  
55  
56  
57  
58  
59  
60  
61  
62  
63  
64  
65  
66  
67  
68  
69  
70  
71  
72  
73  
74  
75  
76  
77  
78  
79  
80  
81  
82  
83  
84  
85  
86  
87  
88  
89  
90  
91  
92  
93  
94  
95  
96  
97  
98  
99  
100

APPENDIX B  
Soil Boring Logs

# MODIFIED BURMISTER SYSTEM

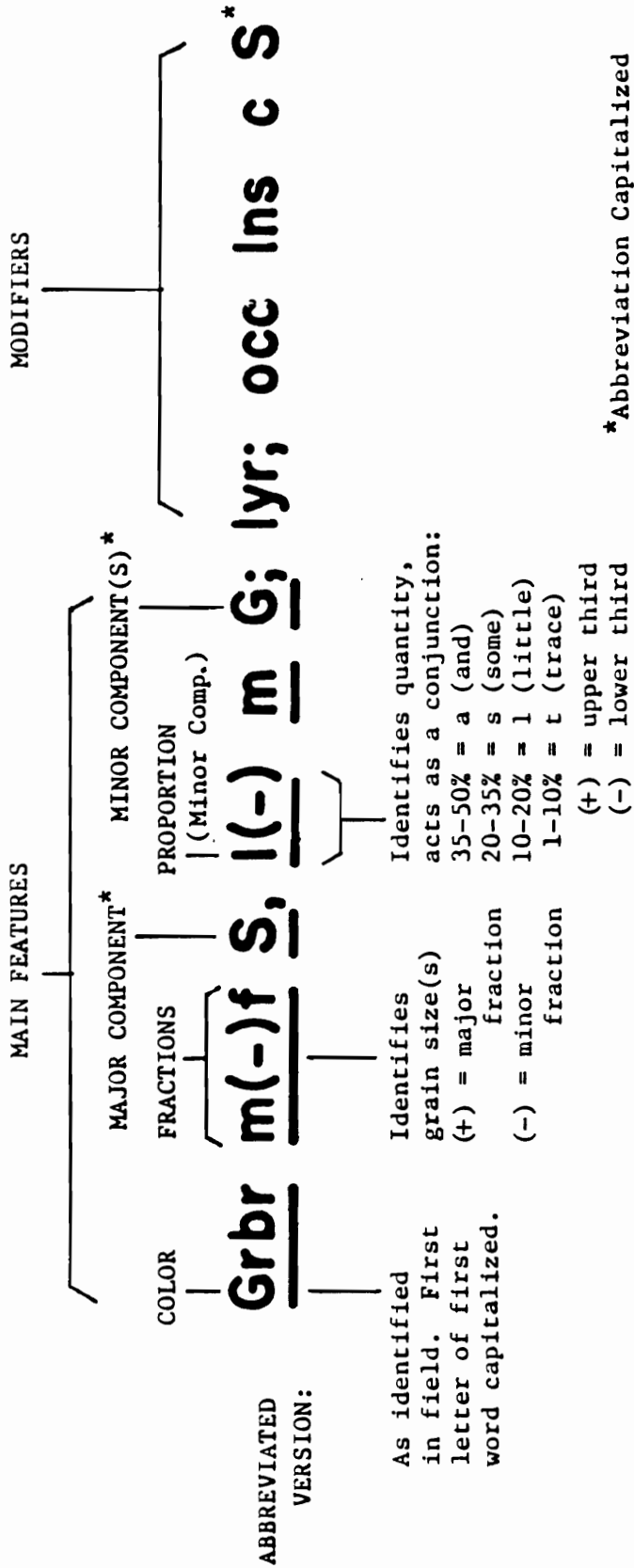

**ABBREVIATED VERSION:** **Gray brown medium (-) to fine SAND, little (-) medium Gravel; layered; occasional lens coarse Sand (SP).**

**UNIFIED SOIL CLASSIFICATION:\*\***  
 Adequate for a generalized stratum description.

Dunn Geoscience Corporation uses a modified BURMISTER SYSTEM for detailed identification of soil components, fractions, and proportions. The UNIFIED SOIL CLASSIFICATION,\*\* based upon field data, is also presented.

UNIFIED SOIL CLASSIFICATION SYSTEM. (ASTM D-2487)

Major Divisions		Group Symbols	Typical Names	Laboratory Classification Criteria		
Coarse-grained soils (More than half of material is larger than No. 200 sieve size)	Gravels (More than half of coarse fraction is larger than No. 4 sieve size)	GW	Well-graded gravels, gravel-sand mixtures, little or no fines	$C_u = \frac{D_{60}}{D_{10}}$ greater than 4; $C_c = \frac{(D_{30})^2}{D_{10} \times D_{60}}$ between 1 and 3 Not meeting all gradation requirements for GW		
		GP	Poorly graded gravels, gravel-sand mixtures, little or no fines			
		Gravels with fines (Appreciable amount of fines)	GM <sup>a</sup> d u	Silty gravels, gravel-sand-silt mixtures	Atterberg limits below "A" line or P.I. less than 4 Above "A" line with P.I. between 4 and 7 are <i>borderline</i> cases requiring use of dual symbols	
			GC	Clayey gravels, gravel-sand-clay mixtures		
	Sands (More than half of coarse fraction is smaller than No. 4 sieve size)	Clean sands (Little or no fines)	SW	Well-graded sands, gravelly sands, little or no fines	$C_u = \frac{D_{60}}{D_{10}}$ greater than 6; $C_c = \frac{(D_{30})^2}{D_{10} \times D_{60}}$ between 1 and 3 Not meeting all gradation requirements for SW	
			SP	Poorly graded sands, gravelly sands, little or no fines		
		Sands with fines (Appreciable amount of fines)	SM <sup>a</sup> d u	Silty sands, sand-silt mixtures	Atterberg limits above "A" line or P.I. less than 4 Limits plotting in hatched zone with P.I. between 4 and 7 are <i>borderline</i> cases requiring use of dual symbols	
			SC	Clayey sands, sand-clay mixtures		
		Fine-grained soils (More than half material is smaller than No. 200 sieve)	Silt and clays (Liquid limit less than 50)	ML	Inorganic silts and very fine sands, rock flour, silty or clayey fine sands, or clayey silts with slight plasticity	<p style="text-align: center;">Plasticity Chart</p>
				CL	Inorganic clays of low to medium plasticity, gravelly clays, sandy clays, silty clays, lean clays	
OL	Organic silts and organic silty clays of low plasticity					
Silt and clays (Liquid limit greater than 50)	MH		Inorganic silts, micaceous or diatomaceous fine sandy or silty soils, elastic silts			
	CH		Inorganic clays of high plasticity, fat clays			
	OH		Organic clays of medium to high plasticity, organic silts			
Highly organic soils	Pt		Peat and other highly organic soils			

Determine percentages of sand and gravel from grain-size curve. Depending on percentage of fines (fraction smaller than No. 200 sieve size), coarse-grained soils are classified as follows:  
 Less than 5 per cent  
 More than 12 per cent  
 5 to 12 per cent

GW, GP, SW, SP  
 GM, GC, SM, SC  
*Borderline* cases requiring dual symbols<sup>b</sup>

<sup>a</sup> Division of GM and SM groups into subdivisions of d and u are for roads and airfields only. Subdivision is based on Atterberg limits; suffix d used when L.L. is 28 or less and the P.I. is 6 or less, the suffix u used when L.L. is greater than 28.  
<sup>b</sup> Borderline classifications, used for soils possessing characteristics of two groups, are designated by combinations of group symbols. For example: GW-GC, well-graded gravel-sand mixture with clay binder.

## VISUAL IDENTIFICATION OF SAMPLES

The samples were identified in accordance with the American Society for Engineering Education System of Definition.

### I. Definition of Soil Components and Fractions

Material	Symbol	Fraction	Sieve Size	Definition
Boulders	Bldr	—	9" +	Material retained on 9" sieve.
Cobbles	Cbl	—	3" to 9"	Material passing the 9" sieve and retained on the 3" sieve.
Gravel	G	coarse (c) medium (m) fine (f)	1" to 3" $\frac{3}{8}$ " to 1" No. 10 to $\frac{3}{8}$ "	Material passing the 3" sieve and retained on the No. 10 sieve.
Sand	S	coarse (c) medium (m) fine (f)	No. 30 to No. 10 No. 60 to No. 30 No. 200 to No. 60	Material passing the No. 10 sieve and retained on the No. 200 sieve.
Silt	\$	—	Passing No. 200 (0.074 mm)	Material passing the No. 200 sieve that is non-plastic in character and exhibits little or no strength when air dried.

#### Organic Silt (O\$)

Material passing the No. 200 sieve which exhibits plastic properties within a certain range of moisture content, and exhibits fine granular and organic characteristics.

		Plasticity	Plasticity Index	
Clayey SILT	Cy\$	Slight (SI)	1 to 5	<b>Clay-Soil</b> Material passing the No. 200 sieve which can be made to exhibit plasticity and clay qualities within a certain range of moisture content, and which exhibits considerable strength when air-dried.
SILT & CLAY	\$&C	Low (L)	5 to 10	
CLAY & SILT	C&\$	Medium (M)	10 to 20	
Silty CLAY	\$yC	High (H)	20 to 40	
CLAY	C	Very High (VH)	40 plus	

### II. Definition of Component Proportions

Component	Written	Proportions	Symbol	Percentage Range by Weight *
Principal	CAPITALS	—		50 or more
Minor	Lower Case	and some little trace	a. s. l. t.	35 to 50 20 to 35 10 to 20 1 to 10

\* Minus sign (—) lower limit, plus sign (+) upper limit, no sign middle range.





**III. Glossary of Modifying Abbreviations**

Category	Symbol	Term	Symbol	Term	Symbol	Term
A. Borings	U/D	Undisturbed	B	Exploratory	A	Auger
B. Samples	C	Casing	L	Lost	U	Undisturbed
	D	Denison	S	Spoon	W	Wash
	O.E.	Open End				
C. Colors	bk	black	gn	green	wh	white
	bl	blue	or	orange	yw	yellow
	br	brown	rd	red	dk	dark
	gr	gray	tn	tan	lt	light
D. Organic Soils	dec	decayed	o	organic	veg	vegetation
	dec'g	decaying	rts	roots	pt	peat
	lig	lignite	ts	topsoil		
E. Rocks	LS	Limestone	rk	rock	Shst	Schist
	Gns	Gneiss	SS	Sandstone	Sh	Shale
F. Fill and Miscellaneous Materials	bldr (s)	boulder (s)	cbl (s)	cobble(s)	gls	glass
	brk (s)	brick (s)	wd	wood	misc	miscellaneous
	cndr (s)	cinder (s)	dbr	debris	rbl	rubble
G. Miscellaneous Terms	do	ditto	pp	pocket	ref	refusal
	el, El	elevation		penetrometer	sm	small
	fgmt (s)	fragment(s)	P. I.	Plasticity	W. L.	water level
	frqt	frequent		Index	W. H.	weight of hammer
	lrg	large	P	pushed	W. R.	weight of rods
	mtld	mottled		pressed		
	no rec	no recovery	pc (s)	piece (s)		
	pen	penetration	rec or R	recovered		
H. Stratified Soils	alt	alternating				
	thk	thick				
	thn	thin				
	w	with				
	prt	parting				
	seam	seam				
	lyr	layer				
	stra	stratum				
	vd c	varved Clay				
	pkt	pocket				
	lns	lens				
	occ	occasional				
	freq	frequent				

- 0 to 1/16" thickness
- 1/16 to 1/2" thickness
- 1/2 to 12" thickness
- greater than 12" thickness
- alternating seams or layers of sand, silt and clay
- small, erratic deposit, usually less than 1 foot
- lenticular deposit
- one or less per foot of thickness
- more than one per foot of thickness

DUNN GEOSCIENCE CORPORATION LATHAM, NEW YORK (518) 783-8102				TEST BORING LOG			BORING NO. BW-1	
PROJECT Volney Landfill							SHEET 1 OF 2	
CLIENT URS Co., Inc.							JOB NO. 553-3-4337	
DRILLING CONTRACTOR John Mathes & Associates, Inc.							ELEVATION 490.69	
PURPOSE RI/FS							DATE STARTED 1/18/86	
GROUNDWATER				CASING	SAMPLE	CORE	DATUM MSL	
DATE	TIME	DEPTH	CASING	TYPE	HSA	SS	DATE FINISHED 1/19/86	
				DIAMETER	4 1/2"	2"	DRILLER Chuck Vous	
				WEIGHT		140 #	INSPECTOR Gordon M. Stevens	
				FALL		30"		

DEPTH FT.	CASING BLOWS	SAMPLE NUMBER	BLOWS ON SAMPLE SPOON PER 6"	UNIFIED CLASSIFICATION	GRAPHIC LOG	IDENTIFICATION	REMARKS
5		S1	2	GW		Br cmfG a, ocmf S, t\$; rts <u>Brown coarse to fine GRAVEL and, organic coarse to fine sand, trace Silt; roots</u>	Rec. = 0.5' Moist
			3				
			3				
			3				
10		S2	1	SW		Br c(+)mf(-) S, + \$, a cmf G <u>Brown coarse(+) to fine(-) SAND, trace Silt, and coarse to fine Gravel</u>	Rec. = 0.8' Moist
			3				
			4				
			6				
15		S3	3	SW		Br c(-)mf G s(-), c(+)mf S, t \$	Rec. = 1.3' Moist
			16				
			19				
			23				
						17.5'	Inferred

<b>DUNN GEOSCIENCE CORPORATION</b> LATHAM, NEW YORK (518) 783-8102	<b>TEST BORING LOG</b>	<b>BORING NO.</b> BW-1
---	------------------------	------------------------

<b>PROJECT</b> Volney Landfill	<b>SHEET</b> 2 OF 2
--------------------------------	---------------------

<b>CLIENT</b> URS Company, Inc.	<b>JOB NO.</b> 553-3-4337
---------------------------------	---------------------------

DEPTH FT.	CASING BLOWS	SAMPLE NUMBER	BLOWS ON SAMPLE SPOON PER 6"	UNIFIED CLASSIFICATION	GRAPHIC LOG	IDENTIFICATION	REMARKS
20		S4	29 43	SP		Br fS, l\$  (LACUSTRINE)	
25		S5	5 17 20 25	SW ML SW CL		<p>----- 24.0' -----</p> <p>24.0 - Br c mfS, lmfG  24.3 - Gr C+\$ t, f S  24.5 - Br c mf+S, lmfG  25.0 - GR \$yC t, f S</p>	Inferred
30							
35							
40							
						End of Boring at 28.0'	

DUNN GEOSCIENCE CORPORATION LATHAM, NEW YORK (518) 783-8102				TEST BORING LOG			BORING NO. BW-2	
PROJECT Volney Landfill							SHEET 1 OF 1	
CLIENT URS Co., Inc.							JOB NO. 553-3-4337	
DRILLING CONTRACTOR John Mathes & Associates, Inc.							ELEVATION 486.69	
PURPOSE RI/FS							DATUM msl	
GROUNDWATER				CASING	SAMPLE	CORE	DATE STARTED 1/21/86	
DATE	TIME	DEPTH	CASING	TYPE	HSA	SS	DATE FINISHED 1/21/86	
				DIAMETER	4 1/2"	2"	DRILLER Kelvin Yount	
				WEIGHT		140#	INSPECTOR Rich Amirault	
				FALL		30"		

DEPTH FT.	CASING BLOWS	SAMPLE NUMBER	BLOWS ON SAMPLE SPOON PER 6"	UNIFIED CLASSIFICATION	GRAPHIC LOG	IDENTIFICATION	REMARKS
5		S-1	8	SW		Br cmfS, a cmf(+)G; rts <u>Brown coarse to fine SAND, and coarse to fine(+) Gravel; roots</u>	Rec. = 0.6' Wet
			9				
			9				
			6				
5		S-2	4	SP		Grbr cmf(+)S, l\$, lfG  <u>Gray brown coarse to fine(+)SAND, little Silt, little fine Gravel</u>	Rec. = 1.0' Wet Leachate odor
			15				
			24				
			33				
10		S-3	44	SM		Rdbr cmf S, s Cy\$, a c(-)mf.G <u>Red brown coarse to fine SAND, some Clayey Silt, and coarse(-) to fine Gravel</u>	Rec. = 0.9' Wet
			100/.4				
15						(FILL)	trash at 8' inferred
						----- 9.0' -----	
						(LODGE MENT TILL)	
						End of Boring at 10.9'	

<b>DUNN GEOSCIENCE CORPORATION</b> LATHAM, NEW YORK (518) 783-8102	<b>TEST BORING LOG</b>	<b>BORING NO.</b> BW-3D
---	------------------------	-------------------------

**PROJECT** Volney Landfill

**CLIENT** URS Co., Inc. **SHEET 1 OF 5**

**DRILLING CONTRACTOR** John Mathes & Associates **JOB NO.** 553-3-4337

**PURPOSE** RI/FS **ELEVATION** 473.38

**GROUNDWATER** **CASING** HSA **SAMPLE** SS **CORE** **DATUM** msl

**DATE** **TIME** **DEPTH** **CASING** **TYPE** **DATE STARTED** 1/18/86

**DIAMETER** 4 1/2" ID **2"** **DATE FINISHED** 1/20/86

**WEIGHT** 140# **DRILLER** Kelvin Yount

**FALL** 30" **INSPECTOR** Hal Hatfield

DEPTH FT.	CASING BLOWS	SAMPLE NUMBER	BLOWS ON SAMPLE SPOON PER 6"	UNIFIED CLASSIFICATION	GRAPHIC LOG	IDENTIFICATION	REMARKS
5		S-1	4	SM		Rdbr fS, l(+)\$, s cmf G; cbl fgmts;rts	Rec. = 1.0' Damp TIP=Ambient
			19				
			27				
			72				
		S-2	20	SM		Rdbr c(-)mf S, t\$, a m(+)f G	Rec. = 0.7' Damp TIP = Ambient
			57				
			55				
			12				
		S-3	8	SM		Br mf(+)S, l(+)\$, 1 cmf(+)G  Br cmf(+) S, l\$, s(-) mf G <u>Brown coarse to fine(+)SAND, little Silt, some(-)medium to fine Gravel</u>	Rec. = 1.1' Moist TIP = Ambient
			8				
			12				
			---				
	S-4	WR	SM	Br c(-)mf(+) S, t\$, t(+) f G	Water at 6.0'  Rec. = 1.5' Wet TIP = Ambient		
		WR					
		1					
		3					
	S-5	WR	SM	Br fS, s\$	8.0'  Rec. = 1.3' Wet TIP = Ambient		
		WR					
		1					

DUNN GEOSCIENCE CORPORATION LATHAM, NEW YORK	TEST BORING LOG	BORING NO. BW-3D
---	-----------------	------------------

PROJECT Volney Landfill	SHEET 2 OF 5
-------------------------	--------------

CLIENT URS Company, Inc.	JOB NO. 553-3-4337
--------------------------	--------------------

DEPTH FT.	CASING BLOWS	SAMPLE NO.	BLOWS ON SAMPLE SPOON PER 6"	UNIFIED CLASSIFICATION	GRAPHIC LOG	IDENTIFICATION	REMARKS
15		S-6	3	SM		Br m(-)fS, 1\$; w seam bk f S	Rec. = 1.1' Wet TIP = Ambient
			3				
			1				
			3				
		S-7	WR	SM		Br fS, 1\$ <u>Brown fine SAND, little Silt</u>  (LACUSTRINE)	Rec. = 2.0' Wet TIP = Ambient
			6				
			8				
			10				
		S-8	WR	SM		Br fS, s(-)\$, l(-)mf G	Rec. = 0.8' Wet TIP = Ambient
			3				
	6						
	S-9	9	SP-SM	Br fS, l(-) \$	Rec. = 2.0' Wet TIP = Ambient		
		6					
		14					
		15					
20		S-10	15	SP-SM	Br fS, l(-) \$	Rec. = 2.0' Wet TIP = Ambient	
			4				
			10				
		S-11	17	SP-SM	Br f S, l(-) \$	Rec. = 2.0' Wet TIP = Ambient	
			19				
			3				
		13	SP-SM	Br f S, l(-) \$	Rec. = 2.0' Wet TIP = Ambient		
		18		Br f S, l(-)\$, lfG			
		25					

<b>DUNN GEOSCIENCE CORPORATION</b> LATHAM, NEW YORK	<b>TEST BORING LOG</b>	<b>BORING NO.</b> BW-3D
--	------------------------	-------------------------

<b>PROJECT</b> Volney Landfill	<b>SHEET</b> 3 <b>OF</b> 5
--------------------------------	----------------------------

<b>CLIENT</b> URS Company, Inc.	<b>JOB NO.</b> 553-3-4337
---------------------------------	---------------------------

DEPTH FT.	CASING BLOWS	SAMPLE NO.	BLOWS ON SAMPLE SPOON PER 6"	UNIFIED CLASSIFICATION	GRAPHIC LOG	IDENTIFICATION	REMARKS	
25		S-12	8	SP-SM		Br f S, 1(-)\$, 1(-)f G	Rec. = 2.0' Wet TIP = Ambient	
			14					
			25	SP-SM				
		S-13	26		Br f S, 1(-)\$; w lyr br \$	Rec. = 2.0' Wet TIP = Ambient		
			12					
			14	SP-SM	Br f S, 1(-)\$, t f G <u>Brown fine SAND, little(-)Silt, trace fine Gravel</u>			
30		S-14	21		(LACUSTRINE)	Br f S, 1(+) \$, t(+) f G	Rec. = 2.0' Wet TIP = Ambient	
			7	SM				----- 26.8' -----
			12					
		S-15	17	ML	Br \$ a(-), f S	Rec. = 2.0' Wet TIP = Ambient		
			21		----- 27.7' -----			
			5					
		S-16	7	SM	Br f S, s(-) \$, t(-) f G	Rec. = 2.0' Wet TIP = Ambient		
			9					
			14					
		S-17	8		Br f S, s\$, tmG	Rec. = 2.0' Wet TIP = Ambient		
			8	SM			<u>Brown fine SAND, some Silt, trace medium Gravel</u>	
			9					
		S-17	12		Br f S, s\$, 1 mf(+) G	Rec. = 2.0' Wet TIP = Ambient		
			8				----- 33.5' -----	
			10	SM			Br \$ a(-), f S, 1 mf(+) G	
			10	ML				



DUNN GEOSCIENCE CORPORATION LATHAM, NEW YORK				TEST BORING LOG		BORING NO. BW-3 D		
PROJECT Volney Landfill						SHEET 4 OF 5		
CLIENT URS Company, Inc.						JOB NO. 553-3-4337		
DEPTH FT.	CASING BLOWS	SAMPLE NO.	BLOWS ON SAMPLE SPOON PER 6"	UNIFIED CLASSIFICATION	GRAPHIC LOG	IDENTIFICATION	REMARKS	
35		S-18	34	SM		Br fS, s(+) \$, l(+)fG	Rec. = 2.0' Wet TIP = Ambient	
			28					
			23					
			28					
40		S-19	66	SM		Brrd cmf(+) S, l\$, a(-) c(+)mf G <u>Brown red coarse to fine(+)SAND,</u> <u>little Silt, and(-) coarse(+) to</u> <u>fine Gravel</u> (LODGEMENT TILL)	Rec. = 2.0' Wet TIP = Ambient	
			58					
			47					
			37					
		S-20	17	SM	24		Br rd fS, a(-) \$, s(-) cmf(+) G	Rec. = 2.0' Wet TIP = Ambient
			60					
			66					
45		S-21	14	SM		Brrd cmf S, l\$, s(+) cmf G	Rec. = 2.0' Wet TIP = Ambient	
			36					
			44					
		100	SM		Brrd cmf(+) S, l\$, s(+) cmf G	Rec. = 1.5' Wet TIP = Ambient		
64								
45		S-22	70	SM		Brrd cmf(+) S, l\$, s(+) cmf G	Rec. = 1.5' Wet TIP = Ambient	
			100/ .4					
			---					
			---					
45		S-23	100/ .3	SM		Br f S, s(+) \$, s(-) cmf(+) G	Rec. = 0.2' Wet TIP = Ambient	
			---					
			---					
			---					



<b>DUNN GEOSCIENCE CORPORATION</b> LATHAM, NEW YORK (518) 783-8102					<b>TEST BORING LOG</b>			<b>BORING NO.</b> BW-4D	
<b>PROJECT</b> Volney Landfill									
<b>CLIENT</b> URS Company, Inc.								<b>SHEET 1 OF 2</b>	
<b>DRILLING CONTRACTOR</b> John Mathes & Associates, Inc.								<b>JOB NO.</b> 553-3-4337	
<b>PURPOSE</b> RI/FS								<b>ELEVATION</b> 483.30	
<b>GROUNDWATER</b>					<b>CASING</b>	<b>SAMPLE</b>	<b>CORE</b>	<b>DATUM</b> msl	
<b>DATE</b>	<b>TIME</b>	<b>DEPTH</b>	<b>CASING</b>	<b>TYPE</b>	HSA	SS		<b>DATE STARTED</b> 1/16/86	
				<b>DIAMETER</b>	4½"	2"		<b>DATE FINISHED</b> 1/16/86	
				<b>WEIGHT</b>		140#		<b>DRILLER</b> Kelvin Yount	
				<b>FALL</b>		30"		<b>INSPECTOR</b> Hal Hatfield	

DEPTH FT.	CASING BLOWS	SAMPLE NUMBER	BLOWS ON SAMPLE SPOON PER 6"	UNIFIED CLASSIFICATION	GRAPHIC LOG	IDENTIFICATION	REMARKS
5		S-1	6	SM		Rd br cmf(+) S, s(+) \$, l(-) f G	Rec. = 0.9' Wet TIP = Ambient
			4				
			4				
			4				
5		S-2	9	SM		Rd br cmf(+) S, s(-) \$, l cf(+) G	Rec. = 0.4' Moist TIP = Ambient
			10				
			10				
			10				
10		S-3	3	SM		Br cmf(+) S, s(+) \$, t(+) mfG Brown coarse to fine(+) SAND, some (+) Silt, trace (+) medium to fine Gravel	Water at 10.0' Rec. = 0.6' Wet TIP = Ambient
			4				
			7				
			15				
15		S-4	100/4	SM		Br rd fS, a \$, l f G; cbl fgmt Brown red fine SAND, and Silt, little fine Gravel; cobble fragment (LODGEMENT TILL)	15.0' Inferred Rec. = 0.4' Wet TIP = Ambient



DUNN GEOSCIENCE CORPORATION LATHAM, NEW YORK (518) 783-8102					TEST BORING LOG			BORING NO. BW-5	
PROJECT Volney Landfill								SHEET 1 OF 1	
CLIENT URS Company, Inc.								JOB NO. 553-3-4337	
DRILLING CONTRACTOR John Mathes & Associates, Inc.								ELEVATION 474.92	
PURPOSE RI/FS								DATUM msl	
GROUNDWATER					CASING	SAMPLE	CORE	DATE STARTED 1/17/86	
DATE	TIME	DEPTH	CASING	TYPE	HSA	SS		DATE FINISHED 1/17/86	
				DIAMETER	4½" ID	2"		DRILLER Kelvin Yount	
				WEIGHT		140#		INSPECTOR Hal Hatfield	
				FALL		30"			

DEPTH FT.	CASING BLOWS	SAMPLE NUMBER	BLOWS ON SAMPLE SPOON PER 6"	UNIFIED CLASSIFICATION	GRAPHIC LOG	IDENTIFICATION	REMARKS	
5		S-1	2	SM		Br f S, s\$, l f G; cbl fgmt; rts Brown fine SAND, some Silt, little fine Gravel; cobble fragment, roots	Rec. = 0.8' Damp TIP = Ambient	
			10					
			9					
			22					
			S-2	2		ML	Br \$; occ lyr f S Brown SILT; occasional layer fine Sand  (LACUSTRINE)	inferred Water at 4.0'  Rec. = 2.0' Wet TIP = Ambient
				4				
				7				
				13				
	10		S-3	8		ML	Gr \$ 1, f S	inferred Rec. = 1.0' Wet TIP = Ambient inferred
				8				
		4						
		2						
15		S-4	21	SM	Rdbr cmf(+) S, 1 \$, s mf G (LODGEMENT TILL)	Rec. = 1.3' Wet TIP = Ambient		
			33					
			47					
			52					
					End of Boring at 17.0'			

<b>DUNN GEOSCIENCE CORPORATION</b> LATHAM, NEW YORK (518) 783-8102	<b>TEST BORING LOG</b>	<b>BORING NO.</b> BW-6
---	------------------------	------------------------

**PROJECT** Volney Landfill

**CLIENT** URS Company, Inc. **SHEET 1 OF 1**

**DRILLING CONTRACTOR** John Mathes & Associates, Inc. **JOB NO.** 553-3-4337

**PURPOSE** RI/FS **ELEVATION** 455.67

**GROUNDWATER** **CASING** **SAMPLE** **CORE** **DATUM** msl

**DATE** **TIME** **DEPTH** **CASING** **TYPE** HSA SS **DATE STARTED** 1/17/86

**DIAMETER** 4½" 2" **DATE FINISHED** 1/17/86

**WEIGHT** 140# **DRILLER** Kelvin Yount

**FALL** 30" **INSPECTOR** Hal Hatfield

DEPTH FT.	CASING BLOWS	SAMPLE NUMBER	BLOWS ON SAMPLE SPOON PER 6"	UNIFIED CLASSIFICATION	GRAPHIC LOG	IDENTIFICATION	REMARKS
		S-1	3 4 7 10	SM		Cobbles at Surface Br cmf(+)S, t\$, s mf(+) G	Rec. = 1.2' Damp TIP = Ambient
5		S-2	2 6 3 4	SP-SM		Br cmf S, l(-) \$, s(+) mf(+) G <u>Brown coarse to fine SAND, little (-)</u> <u>Silt, some(+) medium to fine(+)</u> <u>Gravel</u>	Water at 4.0'  Rec. = 0.8' Wet TIP = Ambient
10		S-3	5 5 4 2	SM		Br cmf(+) S, t \$, a c(+)mf G	Rec. = 0.9' Wet TIP = Ambient
15		S-4	6 6 5 5	SM		Br cmf(+) S, l \$, t mf G	Rec. = 2.0' Wet TIP = Ambient
End of Boring at 18.0'							

<b>DUNN GEOSCIENCE CORPORATION</b> LATHAM, NEW YORK (518) 783-8102	<b>TEST BORING LOG</b>	<b>BORING NO.</b> BW-7S
---	------------------------	-------------------------

<b>PROJECT</b> Volney Landfill	<b>SHEET 1 OF 2</b>
--------------------------------	---------------------

<b>CLIENT</b> URS Company, Inc.	<b>JOB NO.</b> 553-3-4337
---------------------------------	---------------------------

<b>DRILLING CONTRACTOR</b> John Mathes & Associates, Inc.	<b>ELEVATION</b> 453.71
---	-------------------------

<b>PURPOSE</b> RI/ES	<b>DATUM</b> msl
----------------------	------------------

<b>GROUNDWATER</b>	<b>CASING</b> HSA	<b>SAMPLE</b> SS	<b>CORE</b>
--------------------	-------------------	------------------	-------------

<b>DATE</b>	<b>TIME</b>	<b>DEPTH</b>	<b>CASING</b>	<b>TYPE</b>	<b>DATE STARTED</b> 1/19/86
-------------	-------------	--------------	---------------	-------------	-----------------------------

				<b>DIAMETER</b> 4½"	<b>DATE FINISHED</b> 1/20/86
--	--	--	--	---------------------	------------------------------

				<b>WEIGHT</b> 140#	<b>DRILLER</b> Chuck Vous
--	--	--	--	--------------------	---------------------------

				<b>FALL</b> 30"	<b>INSPECTOR</b> Gordon M. Stevens
--	--	--	--	-----------------	------------------------------------

DEPTH FT.	CASING BLOWS	SAMPLE NUMBER	BLOWS ON SAMPLE SPOON PER 6"	UNIFIED CLASSIFICATION	GRAPHIC LOG	IDENTIFICATION	REMARKS
-----------	--------------	---------------	------------------------------	------------------------	-------------	----------------	---------

0							
5		S-1	1 6 6 9	GW		Dkbr cmf G s, cmf S, t \$&C Dark brown coarse to fine GRAVEL some, coarse to fine Sand, trace Silt and Clay	Rec. = 0.8' Wet
						7.5'	Inferred

10		S-2	1 5 7 5	SP		Br m(-)f S, l \$ Brown medium(-) to fine SAND, little Silt	Rec. = 1.3' Wet
						12.5'	Inferred

15		S-3	5 10 10 14	SW SP		Br cmf S, t \$, 1 mf G Br f S, l \$ Brown fine SAND, little Silt	Rec. = 2.0' Wet
----	--	-----	---------------------	----------	--	--	--------------------

						(LACUSTRINE) 17.5'	Inferred
--	--	--	--	--	--	-----------------------	----------

DEPTH FT.	CASING BLOWS	SAMPLE NUMBER	BLOWS ON SAMPLE SPOON PER 6"	UNIFIED CLASSIFICATION	GRAPHIC LOG	IDENTIFICATION	REMARKS
		S-4	4 7	CL		Gr \$yC <u>Gray Silty CLAY</u> 22.5'	Inferred
25		S-5	4 5 4 5	SC		Gr f S,a C&\$ <u>Gray fine SAND, and Clay &amp; Silt</u>  (LACUSTRINE)	Rec. = 1.3' Wet
30		S-6	9 7 6 13	SC SW		Gr f S,a C&\$ 30.0'  Grrd cmf S,1 cmf G <u>Gray red coarse to fine SAND, little coarse to fine Gravel</u> 31.5'	Rec. = 1.5' Wet  Inferred, compact soil
35		S-7	17 31 28 24			Rd cmf(+) S, s(-) S+C, s cmf G <u>Red coarse to fine (+) SAND, some(-) Silt and Clay, some coarse to fine Gravel</u> (LODGEMENT TILL)	Rec. = 1.4' Moist
						End of Boring at 36.0'	



<b>DUNN GEOSCIENCE CORPORATION</b> LATHAM, NEW YORK (518) 783-8102	<b>TEST BORING LOG</b>	<b>BORING NO.</b> BW-8D
---	------------------------	-------------------------

<b>PROJECT</b> Volney Landfill
--------------------------------

<b>CLIENT</b> URS Company, Inc.	<b>SHEET</b> 1 OF 4
---------------------------------	---------------------

<b>DRILLING CONTRACTOR</b> John Mathes & Associates, Inc.	<b>JOB NO.</b> 553-3-4337
---	---------------------------

<b>PURPOSE</b> RI/FS	<b>ELEVATION</b> 461.20
----------------------	-------------------------

<b>GROUNDWATER</b>	<b>CASING</b>	<b>SAMPLE</b>	<b>CORE</b>	<b>DATUM</b> msl
--------------------	---------------	---------------	-------------	------------------

<b>DATE</b>	<b>TIME</b>	<b>DEPTH</b>	<b>CASING</b>	<b>TYPE</b>	HSA	SS	<b>DATE STARTED</b> 1/16/86
-------------	-------------	--------------	---------------	-------------	-----	----	-----------------------------

				<b>DIAMETER</b>	4½"	2"	<b>DATE FINISHED</b> 1/17/86
--	--	--	--	-----------------	-----	----	------------------------------

				<b>WEIGHT</b>		140#	<b>DRILLER</b> Chuck Vous
--	--	--	--	---------------	--	------	---------------------------

				<b>FALL</b>		30"	<b>INSPECTOR</b> Gordon M. Stevens
--	--	--	--	-------------	--	-----	------------------------------------

DEPTH FT.	CASING BLOWS	SAMPLE NUMBER	BLOWS ON SAMPLE SPOON PER 6"	UNIFIED CLASSIFICATION	GRAPHIC LOG	IDENTIFICATION	REMARKS
5		S-1	68	SM		Br cm(+)f S, 1 Cy\$, s cmf(+)G	Rec. = 0.4' Dry-frozen
			30				
			24				
			34				
		S-2	15	SM		Br c(-)mf S, 1 Cy\$, s mf G  <u>Brown coarse(-)to fine SAND, little Clayey Silt, some medium to fine Gravel</u>  4.0'	Rec. = 0.4' Dry-frozen
			24				
			30				
			35				
		S-3	4	SP		Br f S,t(+) \$,t(-) m G  <u>Brown fine SAND, trace Silt, trace medium Gravel</u>  (LACUSTRINE)	Rec. = 1.8' Moist
			9				
			7				
		S-4	8	SP		Br f S,t \$	Rec. = 1.7' Moist
			3				
			5				
			6				
	S-5	7	SP	Br f S,t \$	Rec. = 1.3' Moist Capillary Fringe 8.8' Wet		
		3					
		4					
			7				

DUNN GEOSCIENCE CORPORATION LATHAM, NEW YORK				TEST BORING LOG		BORING NO. BW-8D	
PROJECT Volney Landfill						SHEET 2 OF 4	
CLIENT URS Company, Inc.						JOB NO. 553-3-4337	
DEPTH FT.	CASING BLOWS	SAMPLE NO.	BLOWS ON SAMPLE SPOON PER 6"	UNIFIED CLASSIFICATION	GRAPHIC LOG	IDENTIFICATION	REMARKS
10		S-6	2	SP		Grbr f S,t \$	Rec. = 1.8' Wet
			4		Grayish brown fine SAND, trace silt		
			4		(LACUSTRINE)		
			4				
		S-7	WR	SP	Grbr f S,t \$	Rec. = 1.5' Wet Inferred	
			3		----- 12.8'		
			2	SM	Br f S, l \$ &C		
				2	SM	----- 14.0'	Inferred
	15		S-8	6	ML	Br \$&C l,f S	Rec. = 0.8' Moist
				7		Brown SILT & CLAY little, fine Sand	
		9					
			16				
		S-9	10	ML	Br \$&C l,f S	Rec. = 1.7' Moist	
			12		----- 16.6'		
	14		SM	Br f S,l \$&C			
			16	SM	Brown fine SAND, little Silt & Clay	Wet	
20		S-10	6	SM	Br f S,a \$&C	Rec. = 1.3' Wet	
			13		Brown fine SAND, and Silt & Clay		
			8				
			7				
		S-11	5	SM	Br f S,a \$&C	Rec. = 1.2' Wet	
	5			----- 21.0'			
	4		ML	Gr C&S, l,f S			
			5	ML	Gray CLAY & SILT little, fine Sand	Moist	

<b>DUNN GEOSCIENCE CORPORATION</b> LATHAM, NEW YORK	<b>TEST BORING LOG</b>	<b>BORING NO. BW-8D</b>
--	------------------------	-------------------------

<b>PROJECT</b> Volney Landfill	<b>SHEET</b> 3 OF 4
--------------------------------	---------------------

<b>CLIENT</b> URS Company, Inc.	<b>JOB NO.</b> 553-3-4337
---------------------------------	---------------------------

DEPTH FT.	CASING BLOWS	SAMPLE NO.	BLOWS ON SAMPLE SPOON PER 6"	UNIFIED CLASSIFICATION	GRAPHIC LOG	IDENTIFICATION	REMARKS	
25		S-12	3	CL		Gr C&\$ t,f S <u>Gray CLAY &amp; SILT trace, fine Sand</u>  (LACUSTRINE)	Rec. = 1.1' Moist	
			7					
			7					
			7					
			S-13	4	CL		Gr C&\$ t,f S  ----- 24.9'	Rec. = 1.9' Moist
				4				
				1				
			S-14	3	ML			
				4				
				6				
			S-15	6	CL		Gr \$&C 1,f S  ----- 26.5' Gr C&\$ 1,f S	Rec. = 1.0' Moist
				6				
		6						
		S-16	7	CL		Gr C&\$ 1,f S  ----- 29.0'	Rec. = 1.4' Wet	
			4					
			17					
30		S-17	20	SP		Gr cmf S,a \$&C,t c G		
			53					
			37					
			S-16	37	SW		Rdbr c(+)mf S, 1 C&\$, a mf G  <u>Red brown coarse(+)to fine SAND,</u> <u>little Clay &amp; Silt, and medium to</u> <u>fine Gravel</u> (LODGEMENT TILL)	Rec. = 1.5 Wet
				45				
		S-17	18	GW		----- 32.0' Rdbr mf G a,c(+)mf S,t Cy\$ ----- 32.5'	Inferred Rec. = 1.0' Wet	
			23					
			26					
		S-17	16	SW		Rdbr c(+)mf S,t Cy\$,s f G		

<b>DUNN GEOSCIENCE CORPORATION</b> LATHAM, NEW YORK	<b>TEST BORING LOG</b>	<b>BORING NO.</b> BW-8D
--	------------------------	-------------------------

<b>PROJECT</b> Volney Landfill	<b>SHEET</b> 4 <b>OF</b> 4
--------------------------------	----------------------------

<b>CLIENT</b> URS Company, Inc.	<b>JOB NO.</b> 553-3-4337
---------------------------------	---------------------------

DEPTH FT.	CASING BLOWS	SAMPLE NO.	BLOWS ON SAMPLE SPOON PER 6"	UNIFIED CLASSI- FICATION	GRAPHIC LOG	IDENTIFICATION	REMARKS
34		S-18	67	GW		Rdbr c(-)mfG a, cmf(+)S, t(+) Cy\$	Rec. = 1.1' Wet
			23			Reddish brown coarse(-)to fine GRAVEL	
			23			and, coarse to fine(+) Sand, trace(+)	
			30			Clayey Silt	
36		S-19	51	GM		(LODGEMENT TILL)	Inferred
			100/4"			Rdbr cmfG a, cmf(+) S, l \$&C; mtd grgn	
			-----			Reddish brown coarse to fine GRAVEL	
38		S-20	-----	GM		and, coarse to fine(+) Sand, little	Rec. = 0.7' Wet
			111/6"			Silt & Clay; mottled grayish green	
			-----			(LODGEMENT TILL)	Rec. = 0.5' Wet
						Grbr fG a, cmf(+) S, l \$&C	
						End of Boring at 38.5'	

<b>DUNN GEOSCIENCE CORPORATION</b> LATHAM, NEW YORK (518) 783-8102	<b>TEST BORING LOG</b>	<b>BORING NO.</b> BW-9D
---	------------------------	-------------------------

<b>PROJECT</b> Volney Landfill	
--------------------------------	--

<b>CLIENT</b> URS Company, Inc.	<b>SHEET 1 OF 2</b>
---------------------------------	---------------------

<b>DRILLING CONTRACTOR</b> John Mathes & Associates, Inc.	<b>JOB NO.</b> 553-3-4337
---	---------------------------

<b>PURPOSE</b> RI/FS	<b>ELEVATION</b> 494.28
----------------------	-------------------------

<b>GROUNDWATER</b>					<b>CASING</b>	<b>SAMPLE</b>	<b>CORE</b>	<b>DATUM</b> msl
<b>DATE</b>	<b>TIME</b>	<b>DEPTH</b>	<b>CASING</b>	<b>TYPE</b>	HSA	SS		<b>DATE STARTED</b> 1/10/86
				<b>DIAMETER</b>	4½"	2"		<b>DATE FINISHED</b> 1/10/86
				<b>WEIGHT</b>		140#		<b>DRILLER</b> Kelvin Yount
				<b>FALL</b>		30"		<b>INSPECTOR</b> Hal Hatfield

DEPTH FT.	CASING BLOWS	SAMPLE NUMBER	BLOWS ON SAMPLE SPOON PER 6"	UNIFIED CLASSIFICATION	GRAPHIC LOG	IDENTIFICATION	REMARKS
5		S-1	5	SM		Br f S,s \$,l(-) f G;rts	Rec. = 1.2' Damp Tip = Ambient
			8				
			8				
			10				
5		S-2	2	SP SM		Br cmf S,l(-) \$,a(-) mf(+) G;wd;db <u>Brown coarse to fine SAND, little(-) Silt, and(-) medium to fine(+) Gravel; wood; debris</u>	Rec. = 0.6' Damp TIP = Ambient Mostly debris
			45				
			7				
			8				
10		S-3	10	SM		Br cmf S,s \$,s(-) f G;db	Rec. = 0.1' Moist TIP = Ambient Half debris
			13				
			6				
			5				
15		S-4	6	SM		Br cmf(+) S,s \$ l mf(+) G;wd;db	Rec. = 0.5' Moist TIP = Ambient Half debris
			5				
			4				
			9				



<b>DUNN GEOSCIENCE CORPORATION</b> LATHAM, NEW YORK (518) 783-8102				<b>TEST BORING LOG</b>			<b>BORING NO.</b> BW-10S	
<b>PROJECT</b> Volney Landfill							<b>SHEET 1 OF 3</b>	
<b>CLIENT</b> URS Company, Inc.							<b>JOB NO.</b> 553-3-4337	
<b>DRILLING CONTRACTOR</b> John Mathes & Associates, Inc.							<b>ELEVATION</b> 492.48	
<b>PURPOSE</b> RI/FS							<b>DATUM</b> msl	
<b>GROUNDWATER</b>				<b>CASING</b>	<b>SAMPLE</b>	<b>CORE</b>		
<b>DATE</b>	<b>TIME</b>	<b>DEPTH</b>	<b>CASING</b>	<b>TYPE</b>	HSA	SS	<b>DATE STARTED</b> 1/10/86	
				<b>DIAMETER</b>	4½"	2"	<b>DATE FINISHED</b> 1/15/86	
				<b>WEIGHT</b>		140#	<b>DRILLER</b> Chuck Vous	
				<b>FALL</b>		30"	<b>INSPECTOR</b> Gordon M. Stevens	

DEPTH FT.	CASING BLOWS	SAMPLE NUMBER	BLOWS ON SAMPLE SPOON PER 6"	UNIFIED CLASSIFICATION	GRAPHIC LOG	IDENTIFICATION	REMARKS
5		S-1	9	SW		Br cmf(+) S,t \$l cmf(+) G;dbr	Rec. = 1.3' Moist 15% debris
			10			<u>Brown coarse to fine(+) SAND, trace</u>	
			13			<u>Silt, little coarse to fine(+)</u>	
			13			<u>Gravel; debris</u> (FILL)	
		S-2	10	GP		Dkbr f G,a cmf S,t \$;dbr	Rec. = 0.3' Moist 90% debris
			19				
			11				
			12				
		S-3	5			Dkbr Dbr&wd,1 fS,1 fG	Rec. = 0.2' Moist 90% debris
			16				
			18				
			25				
		S-4	ref			Dbr	Rec. = 0.0'
			---				
			---				
	---						
	S-5	42	SW	Dbr	Rec. = 1.5' Moist		
		18		----- 8.7'			
		34		Br c(+)mf S,s Cy\$, s cmf(+) G			

<b>DUNN GEOSCIENCE CORPORATION</b> LATHAM, NEW YORK	<b>TEST BORING LOG</b>	<b>BORING NO.</b> BW-10S
--	------------------------	--------------------------

<b>PROJECT</b> Volney Landfill	<b>SHEET</b> 2 OF 3
<b>CLIENT</b> URS Company, Inc.	<b>JOB NO.</b> 553-3-4337

DEPTH FT.	CASING BLOWS	SAMPLE NO.	BLOWS ON SAMPLE SPOON PER 6"	UNIFIED CLASSIFICATION	GRAPHIC LOG	IDENTIFICATION	REMARKS				
10		S-6	5			Dbr	Rec. = 0.2' Wet				
			9								
			46								
			11								
		S-7	2					SC	Br cmf S,l \$yC,t mf G;dbr	Rec. = 0.3' Moist 50% debris	
			9								
			8								
			S-8					9	SC	Br cmf S,a \$yC,t fG;dbr	Rec. = 0.3' Moist 50% debris
		6									
		16									
15		S-9	10			Br c(-)mf G a,c(+)mf S,s \$yC;dbr <u>Brown coarse(-)to fine GRAVEL and, coarse(+) to fine Sand, some Silty Clay; debris</u>	Rec. = 0.3' Sl. Moist 40% debris				
			12								
			3					GC			
			S-10			65					
		---									
		---									
		---									
			S-10			4	GC	Br cmf G,a cmf S,s \$yC <u>Brown coarse to fine GRAVEL, and coarse to fine Sand, some Silty Clay</u> (LODGEMENT TILL)	Rec. = 1.0' Sl. Moist		
		16									
		15									
20		S-11	24			Br cmf(+) G,a cmf S,s \$yC	Rec. = 0.2' Sl. Moist				
			14								
			50/.1								
			---								
			---								









<b>DUNN GEOSCIENCE CORPORATION</b> LATHAM, NEW YORK (518) 783-8102					<b>TEST BORING LOG</b>			<b>BORING NO.</b> BW-12	
<b>PROJECT</b> Volney Landfill								<b>SHEET 1 OF 1</b>	
<b>CLIENT</b> URS Company, Inc.								<b>JOB NO.</b> 553-3-4337	
<b>DRILLING CONTRACTOR</b> John Mathes & Associates								<b>ELEVATION</b> 495.79	
<b>PURPOSE</b> RI/FS								<b>DATUM</b> msl	
<b>GROUNDWATER</b>					<b>CASING</b>	<b>SAMPLE</b>	<b>CORE</b>	<b>DATE STARTED</b> 1/18/86	
<b>DATE</b>	<b>TIME</b>	<b>DEPTH</b>	<b>CASING</b>	<b>TYPE</b>	HSA	SS		<b>DATE FINISHED</b> 1/18/86	
				<b>DIAMETER</b>	4 1/4"	2"		<b>DRILLER</b> Chuck Vous	
				<b>WEIGHT</b>		140#		<b>INSPECTOR</b> Gordon M. Stevens	
				<b>FALL</b>		30"			

DEPTH FT.	CASING BLOWS	SAMPLE NUMBER	BLOWS ON SAMPLE SPOON PER 6"	UNIFIED CLASSIFICATION	GRAPHIC LOG	IDENTIFICATION	REMARKS
5		S-1		GW		Br cmf G a,c(+)mf S,t Cy\$  <u>Brown coarse to fine GRAVEL and, coarse(+)to fine(-) Sand, trace Clayey Silt</u>	Rec. = 0.5' Moist
			5				
			5				
			4				
10		S-2		GW		Br cmf G l, cmf S, t Cy\$	Rec. = 0.5' Moist
			13				
			19				
			27				
15		S-3		SM		Rdbr cmf(+) S, l Cy\$, a cmf G <u>Reddish brown coarse to fine (+) SAND little Clayey Silt, and coarse to fine Gravel</u>  (LODGEMENT TILL)	12.5' inferred  Rec. = 1.3' Moist
			34				
			64				
			45 @ .2				
						End of Boring at 16.0	



<b>DUNN GEOSCIENCE CORPORATION</b> LATHAM, NEW YORK (518) 783-8102				<b>TEST BORING LOG</b>			<b>BORING NO.</b> BW-14	
PROJECT Volney Landfill							SHEET 1 OF 1	
CLIENT URS Company, Inc.							JOB NO. 553-3-4337	
DRILLING CONTRACTOR John Mathes & Associates, Inc.							ELEVATION 454.65	
PURPOSE RI/FS							DATUM msl	
GROUNDWATER				CASING	SAMPLE	CORE	DATE STARTED 1/20/86	
DATE	TIME	DEPTH	CASING	TYPE	HSA	SS	DATE FINISHED 1/20/86	
				DIAMETER	4 1/4"	2"	DRILLER Chuck Vous	
				WEIGHT		140#	INSPECTOR Gordon M. Stevens	
				FALL		30"		

DEPTH FT.	CASING BLOWS	SAMPLE NUMBER	BLOWS ON SAMPLE SPOON PER 6"	UNIFIED CLASSIFICATION	GRAPHIC LOG	IDENTIFICATION	REMARKS
5		S-1	1			<u>Br m(-)fS, 1\$</u> <u>Brown medium(-) to fine SAND,</u> <u>little Silt</u>	Rec. = 1.5' Wet
			10				
			8				
			9				
10		S-2	WR			<u>Br mf(+) S, 1(+) \$</u> <u>Brown medium to fine (+) SAND,</u> <u>little Silt</u>	Rec. = 1.3' Wet
			3				
			4				
			12				
(LACUSTRINE)							
15		S-3	14			<u>Br fS, 1\$</u>	Rec. = 2.0' Wet
			30				
			14				
			13			<u>Rdbr cmf S, 1\$&amp;C, a cmf G</u> <u>Reddish brown coarse to fine SAND,</u> <u>little Silt &amp; Clay, and coarse to</u> <u>fine Gravel (LODGEMENT TILL)</u>	16.0'
End of Boring at 16.0'							

DUNN GEOSCIENCE CORPORATION LATHAM, NEW YORK (518) 783-8102					TEST BORING LOG			BORING NO. BW-15	
PROJECT Volney Landfill								SHEET 1 OF 1	
CLIENT URS Co., Inc.								JOB NO. 553-3-4337	
DRILLING CONTRACTOR John Mathes & Associates, Inc.								ELEVATION 449.47	
PURPOSE RI/FS								DATUM msl	
GROUNDWATER					CASING	SAMPLE	CORE	DATE STARTED 1/17/86	
DATE	TIME	DEPTH	CASING	TYPE	HSA	SS		DATE FINISHED 1/17/86	
				DIAMETER	4½"	2"		DRILLER Chuck Vous	
				WEIGHT		140#		INSPECTOR Gordon M. Stevens	
				FALL		30"			

DEPTH FT.	CASING BLOWS	SAMPLE NUMBER	BLOWS ON SAMPLE SPOON PER 6"	UNIFIED CLASSIFICATION	GRAPHIC LOG	IDENTIFICATION	REMARKS
5		S-1	5	SM SP		BrfS, 1 Cy\$ BrfS, t\$	Rec. = 2.0' Moist Wet
			8				
			10				
			10				
10		S-2	2	SP		BrfS, t\$	Rec. = 1.5' Wet
			12				
			18				
			22				
15		S-3	3	SW		Br cmf(+)S, t\$; seams cS <u>Brown coarse to fine(+)SAND, trace Silt; seams of coarse SAND</u>	inferred  Rec. = 1.5' Moist
			9				
			17				
			22				
						End of Boring at 16.0'	

<b>DUNN GEOSCIENCE CORPORATION</b> LATHAM, NEW YORK (518) 783-8102				<b>TEST BORING LOG</b>			<b>BORING NO.</b> BW-16	
<b>PROJECT</b> Volney Landfill							<b>SHEET 1 OF 1</b>	
<b>CLIENT</b> URS Company, Inc.							<b>JOB NO.</b> 553-3-4337	
<b>DRILLING CONTRACTOR</b> John Mathes & Associates, Inc.							<b>ELEVATION</b> 465.52	
<b>PURPOSE</b> RI/FS							<b>DATUM</b> msl	
<b>GROUNDWATER</b>				<b>CASING</b>	<b>SAMPLE</b>	<b>CORE</b>		
<b>DATE</b>	<b>TIME</b>	<b>DEPTH</b>	<b>CASING</b>	<b>TYPE</b>	HSA	SS	<b>DATE STARTED</b> 1/17/86	
				<b>DIAMETER</b>	4 1/2"	2"	<b>DATE FINISHED</b> 1/17/86	
				<b>WEIGHT</b>		140#	<b>DRILLER</b> Chuck Vous	
				<b>FALL</b>		30"	<b>INSPECTOR</b> Gordon M. Stevens	

DEPTH FT.	CASING BLOWS	SAMPLE NUMBER	BLOWS ON SAMPLE SPOON PER 6"	UNIFIED CLASSIFICATION	GRAPHIC LOG	IDENTIFICATION	REMARKS
5		S-1	2	SW		Br cmfS, smfG, t\$	Rec. = 1.6 Wet Water table 4.5
			4				
			9				
			20				
10		S-2	WR	SW		Br cmf(-)S, tmfG, t\$	Rec. = 1.2 Wet
			4	SM			
			8				
			7				
15		S-3	WR	SM		Rdbr cmf(+)S, smfG, s\$&C	Rec. = 1.8 Wet
			9				
			14				
			15				
						(LODGEMENT TILL) End of Boring at 16.1'	



<b>DUNN GEOSCIENCE CORPORATION</b> LATHAM, NEW YORK (518) 783-8102					<b>TEST BORING LOG</b>			<b>BORING NO.</b> BW-17	
<b>PROJECT</b> Volney Landfill								<b>SHEET 1 OF 1</b>	
<b>CLIENT</b> URS Company, Inc.								<b>JOB NO.</b> 553-3-4337	
<b>DRILLING CONTRACTOR</b> John Mathes & Associates, Inc.								<b>ELEVATION</b> 455.87	
<b>PURPOSE</b> RI/FS								<b>DATUM</b> msl	
<b>GROUNDWATER</b>					<b>CASING</b>	<b>SAMPLE</b>	<b>CORE</b>		
<b>DATE</b>	<b>TIME</b>	<b>DEPTH</b>	<b>CASING</b>	<b>TYPE</b>	HSA	SS			<b>DATE STARTED</b> 1/17/86
				<b>DIAMETER</b>	4 1/4"	2"			<b>DATE FINISHED</b> 1/18/86
				<b>WEIGHT</b>		140#			<b>DRILLER</b> Chuck Vous
				<b>FALL</b>		30"			<b>INSPECTOR</b> Gordon M. Stevens

DEPTH FT.	CASING BLOWS	SAMPLE NUMBER	BLOWS ON SAMPLE SPOON PER 6"	UNIFIED CLASSIFICATION	GRAPHIC LOG	IDENTIFICATION	REMARKS
5		S-1		SP		Brown fine SAND, trace Silt	Rec. = 1.6' Moist
			4				
			7	SM			
			7				
7							
10		S-2	5	SM		(LACUSTRINE)	Water at 8.0' inferred
			7				
			33				
			28				
15		S-3	7	SM		Rd br cmf(+) S, 1 \$+C, s(+) cmf G	Rec. = 1.5' Wet
			31				
			70				
			ref				
						End of Boring at 16.3'	

<b>DUNN GEOSCIENCE CORPORATION</b> LATHAM, NEW YORK (518) 783-8102				<b>TEST BORING LOG</b>			<b>BORING NO.</b> BW-17a	
<b>PROJECT</b> Volney Landfill							<b>SHEET 1 OF 1</b>	
<b>CLIENT</b> URS Company, Inc.							<b>JOB NO.</b> 553-3-4337	
<b>DRILLING CONTRACTOR</b> John Mathes & Associates, Inc.							<b>ELEVATION</b> 447.60	
<b>PURPOSE</b> RI/FS							<b>DATUM</b> msl	
<b>GROUNDWATER</b>				<b>CASING</b>	<b>SAMPLE</b>	<b>CORE</b>		
<b>DATE</b>	<b>TIME</b>	<b>DEPTH</b>	<b>CASING</b>	<b>TYPE</b>	HSA	SS	<b>DATE STARTED</b> 1/18/86	
				<b>DIAMETER</b>	4½"	2"	<b>DATE FINISHED</b> 1/18/86	
				<b>WEIGHT</b>		140#	<b>DRILLER</b> Chuck Vous	
				<b>FALL</b>		30"	<b>INSPECTOR</b> Gordon M. Stevens	

DEPTH FT.	CASING BLOWS	SAMPLE NUMBER	BLOWS ON SAMPLE SPOON PER 6"	UNIFIED CLASSIFICATION	GRAPHIC LOG	IDENTIFICATION	REMARKS	
5		S-1	2	GP		Dkbr mf Ga, o cmf S,t \$	4.2'	Rec. = 1.8'
			1	CL		Dkgr o \$&C t,f S	4.9'	Wet
			3	SP		Dkbr mf S,t \$;rts		
			4					
10		S-2				(ALLUVIUM)	7.5'	Inferred
				GC		Br mf G a, cmf S, l Cy\$	9.2'	Rec. = 1.5'
			5	SP		Rdbr c(+)mf S,t \$		Wet
			8	ML		Gr C&\$ l, f S	10.1'	
15		S-3					12.5'	Inferred
			WR			Grbr cmf(+) S, a c(-)mf G, l(-) Cy\$		Rec. = 1.0'
			10	SW		Grayish brown coarse to fine(+) SAND,		Wet
			17			and coarse(-) to fine Gravel, little		
			27			(-) Clayey Silt		
						End of Boring at 16.0'		

# MONITORING WELL COMPLETION LOG

## DUNN GEOSCIENCE CORPORATION



5 Northway Lane North  
Latham, NY 12110  
518/783-8102

Project: Volney Landfill

Client: URS

Project #: 553-3-4337

Well #: BW - 8S

Date Drilled: 1/17/86

Date Developed: 2/5/86

### CONSTRUCTION DETAIL

#### WELL DIAGRAM

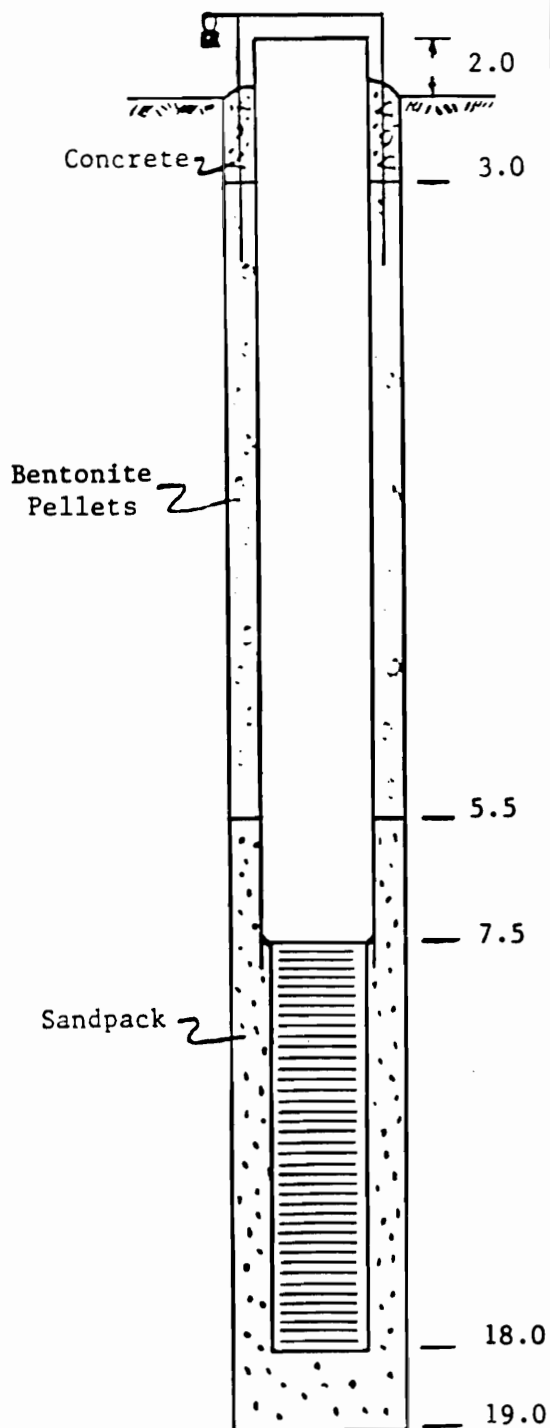

Inspector: Gordon M. Stevens

Drilling Contractor: John Mathes & Associates

Type of Well: Monitoring

Static Water Level: 10.88 Date: 4/1/86

Measuring Point \*

Total Depth of Boring: 19.0

Well Point Depth: 7.5

Drill Casing

Type: HSA Diameter: 4 1/2" ID

Length: \_\_\_\_\_ Material: \_\_\_\_\_

Sampling

Type: No Samples Diameter: \_\_\_\_\_

Weight: \_\_\_\_\_ Fall: \_\_\_\_\_

Interval: \_\_\_\_\_

Pipe Left in Place

Material: SS Diameter: 2"

Length: 20.0 Joint Type: Flush

Screen

Material: SS Diameter: 2"

Slot Size: 10 Interval: 7.5 - 18.0

Stratigraphic Unit Screened: fine sand

Packing

Sand: 0 grade Gravel: \_\_\_\_\_ Natural: \_\_\_\_\_

Amount: \_\_\_\_\_ Interval: 5.5 - 19.0

Seal

Type: Bent. Pellets Interval: 3.0 - 5.5

Locking Casing: Yes  No

Notes:

\* Static water level measuring point is top of riser. Well construction depths are from grade.

# MONITORING WELL COMPLETION LOG

**DUNN GEOSCIENCE CORPORATION**  
 5 Northway Lane North  
 Latham, NY 12110  
 518/783-8102

Project: Volney Landfill  
 Client: URS  
 Project #: 553-3-4337  
 Well #: BW - 8D  
 Date Drilled: 1/16/86 - 1/17/86  
 Date Developed: 2/5/86

## CONSTRUCTION DETAIL

WELL DIAGRAM

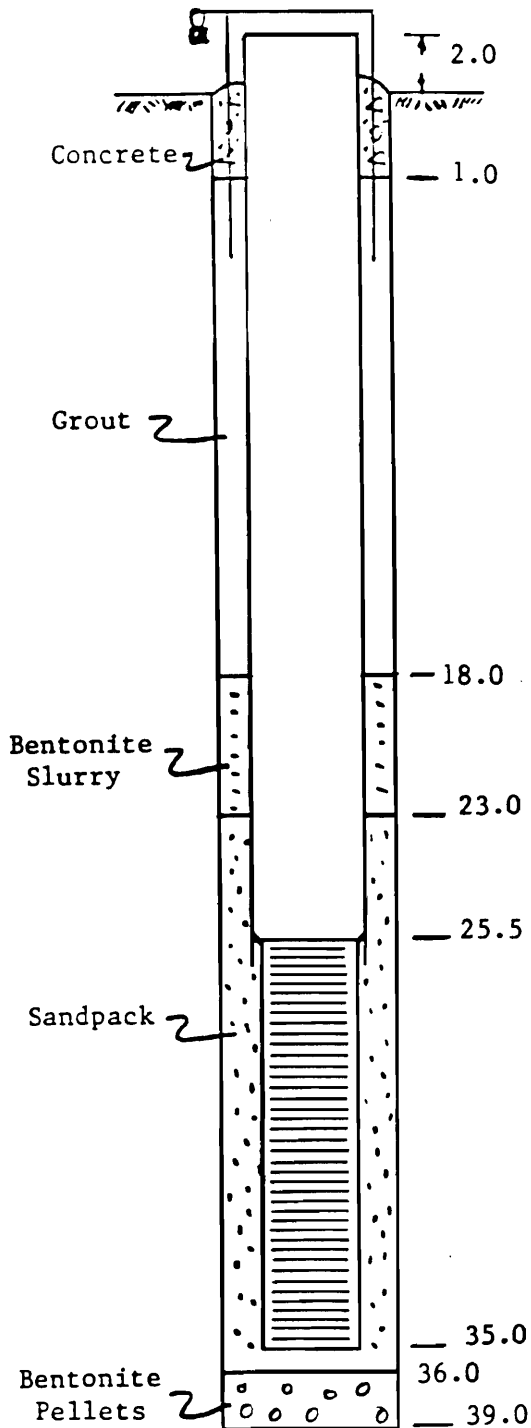

Inspector: Gordon M. Stevens  
 Drilling Contractor: John Mathes & Associates  
 Type of Well: Monitoring  
 Static Water Level: 10.76 Date: 4/1/86  
 Measuring Point \*  
 Total Depth of Boring: 39.0  
 Well Point Depth:  
 Drill Casing  
 Type: HSA Diameter: 4 1/2" ID  
 Length: Material:  
 Sampling  
 Type: SS Diameter: 2"  
 Weight: 140 lbs. Fall: 30"  
 Interval: Continuous  
 Pipe Left in Place  
 Material: SS Diameter: 2"  
 Length: 37.0 Joint Type: Flush  
 Screen  
 Material: SS Diameter: 2"  
 Slot Size: 10 Interval: 24.5 - 35.0  
 Stratigraphic Unit Screened: sand and gravel  
 Packing  
 Sand: 0 grade Gravel: Natural  
 Amount: Interval: 23.0 - 18.0  
 Seal  
 Type: Bent. Slurry Interval: 18.0 - 23.0  
 Bent. Pellets Interval: 36.0 - 39.0  
 Locking Casing: Yes  No

**Notes:**

\* Static water level measuring point is top of riser. Well construction depths are from grade.

# MONITORING WELL COMPLETION LOG

## DUNN GEOSCIENCE CORPORATION



5 Northway Lane North  
Latham, NY 12110

518/783-8102

Project: Volney Landfill

Client: URS

Project #: 553-3-4337

Well #: BW-8 Br

Date Drilled: 1/20/86 - 2/6/86

Date Developed: 2/8/86

### CONSTRUCTION DETAIL

#### WELL DIAGRAM

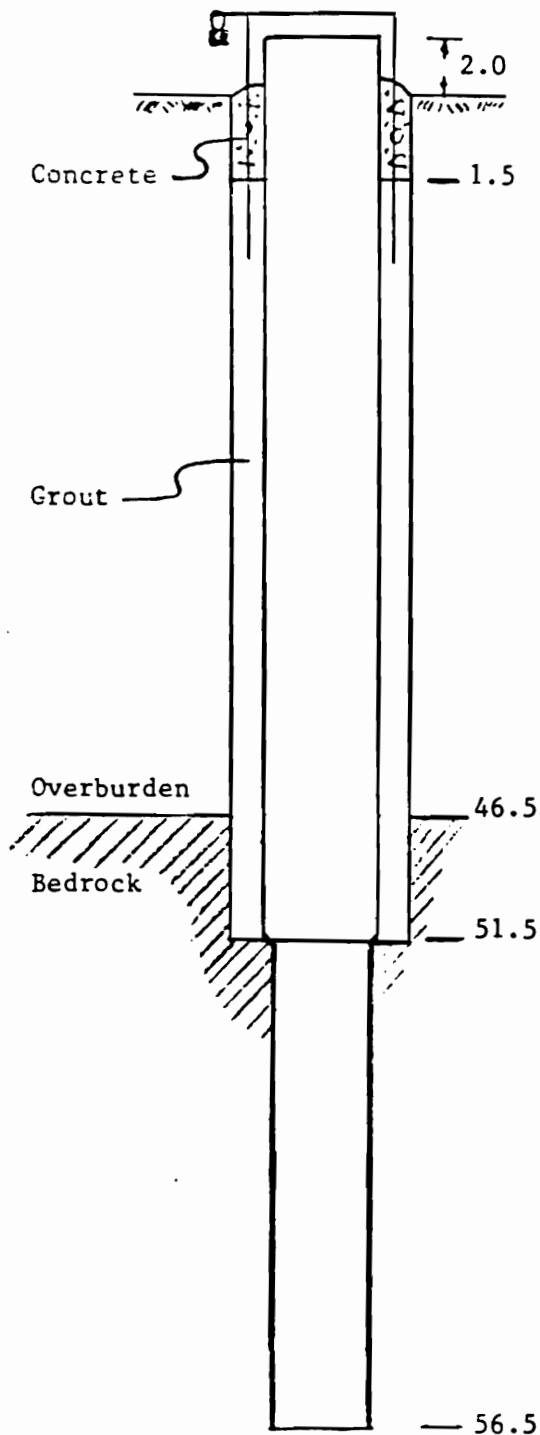

Inspector: Gordon M. Stevens

Drilling Contractor: \*

Type of Well Monitoring

Static Water Level 10.99' Date 4/1/86

Measuring Point \*\*

Total Depth of Boring 56.5'

Well Point Depth 51.5'

Drill Casing

Type Steel Diameter 8"

Sampling

Type Core Diameter 3"

Interval 51.5' - 56.5'

Pipe Left in Place

Material SS Diameter 4"

Length 53.5' Joint Type Flush

Screen

Material Natural Diameter 3"

Interval 51.5 - 56.5

Stratigraphic Unit Screened sandstone

Rock Socket

Seal

Type grout Interval 46.5' - 51.5'

Locking Casing Yes  No

Notes:

\* Soil boring, rock socket and stainless steel riser installed by A.W. Kincaid, Inc. Rock core and locking well protector installed by John Mathes & Associates.

\*\* Static water level measuring point is top of riser. Well construction depths are measured from grade.

# MONITORING WELL COMPLETION LOG

## DUNN GEOSCIENCE CORPORATION



5 Northway Lane North  
Latham, NY 12110  
518/783-8102

Project: Volney Landfill  
Client: URS  
Project #: 553-3-4337  
Well #: BW-9S  
Date Drilled: 1/10/86  
Date Developed: NA

### CONSTRUCTION DETAIL

#### WELL DIAGRAM

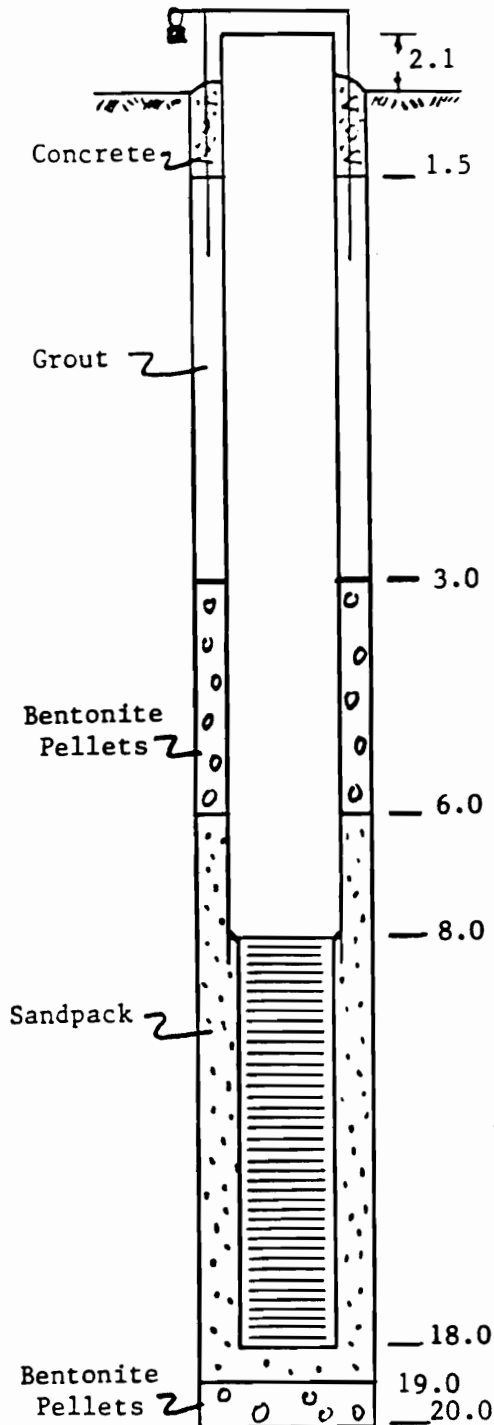

Inspector: Hal Hatfield  
Drilling Contractor: John Mathes & Associates  
Type of Well: Monitoring  
Static Water Level: dry Date: 4/1/86  
Measuring Point \*  
Total Depth of Boring: 20.0  
Well Point Depth:  
Drill Casing  
Type: HSA Diameter: 4 1/2" ID  
Length: Material:  
Sampling  
Type: No Sampling Diameter:  
Weight: Fall:  
Interval:  
Pipe Left in Place  
Material: SS Diameter: 2"  
Length: 20.1 Joint Type: Flush  
Screen  
Material: SS Diameter: 2"  
Slot Size: 10 Interval: 8.0 - 18.0  
Stratigraphic Unit Screened Fill  
Packing  
Sand: 0 grade Gravel: Natural  
Amount: 4 1/3 bags Interval: 6.0 - 19.0  
Seal  
Type: Bent. Pellets Interval: 19.0 - 20.0  
Bentonite Pellets 3.0 - 6.0  
Locking Casing: Yes  No

#### Notes:

\* Static water level measuring point is top of riser. Well construction depths are from grade.

# MONITORING WELL COMPLETION LOG

## DUNN GEOSCIENCE CORPORATION



5 Northway Lane North  
Latham, NY 12110  
518/783-8102

Project: Volney Landfill  
Client: URS  
Project #: 553-3-4337  
Well #: BW-9D  
Date Drilled: 1/10/86  
Date Developed: NA

### CONSTRUCTION DETAIL

#### WELL DIAGRAM

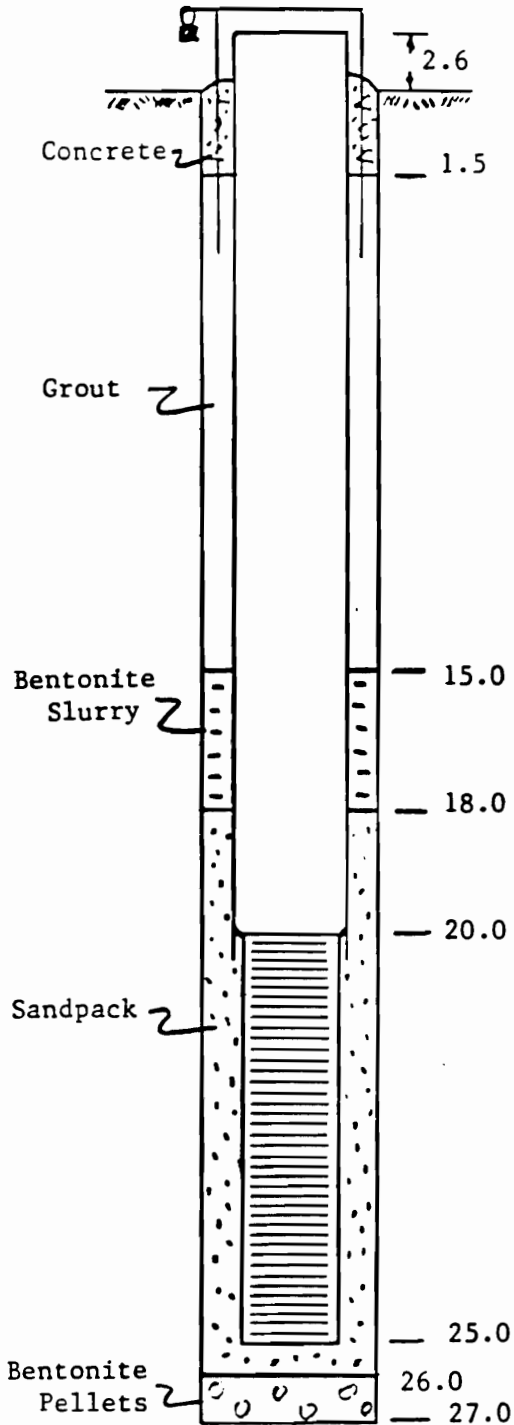

Inspector: Hal Hatfield  
Drilling Contractor: John Mathes & Associates  
Type of Well: Monitoring  
Static Water Level: dry Date: 4/1/86  
Measuring Point \*  
Total Depth of Boring: 27.0  
Well Point Depth: \_\_\_\_\_  
Drill Casing  
Type: HSA Diameter: 4 1/4" ID  
Length: \_\_\_\_\_ Material: \_\_\_\_\_  
Sampling  
Type: SS Diameter: 2"  
Weight: 140 lbs. Fall: 30"  
Interval: Standard (every 5.0')  
Pipe Left in Place  
Material: SS Diameter: 2"  
Length: 27.6 Joint Type: Flush  
Screen  
Material: SS Diameter: 2"  
Slot Size: 10 Interval: 20.0 - 25.0  
Stratigraphic Unit Screened: Lodgement till  
Packing  
Sand: 0 grade Gravel: \_\_\_\_\_ Natural: \_\_\_\_\_  
Amount: 2 bags Interval: 18.0 - 26.0  
Seal  
Type: Bentonite Slurry Interval: 15.0 - 18.0  
Bentonite Pellets Interval: 26.0 - 27.0  
Locking Casing: Yes X No \_\_\_\_\_

Notes:

\* Static water level measuring point is top of riser. Well construction depths are from grade.

# MONITORING WELL COMPLETION LOG

## DUNN GEOSCIENCE CORPORATION



5 Northway Lane North  
Latham, NY 12110  
518/783-8102

Project: Volney Landfill  
Client: URS  
Project #: 553-3-4337  
Well #: BW - 10S  
Date Drilled: 1/15/86  
Date Developed: NA

### CONSTRUCTION DETAIL

#### WELL DIAGRAM

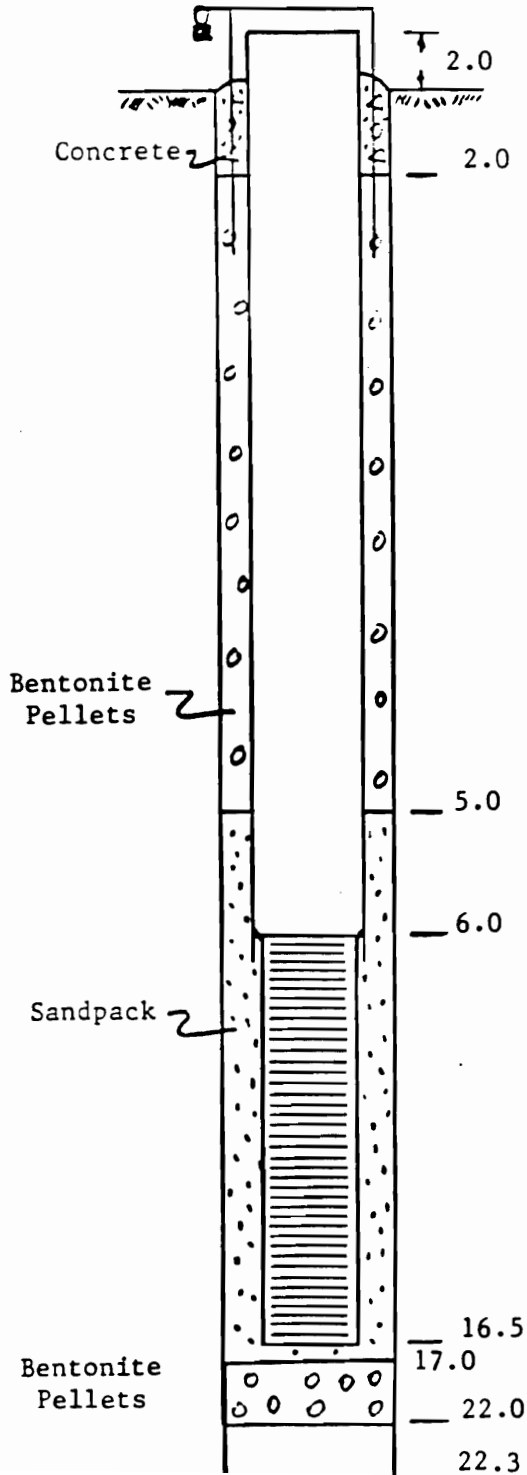

Inspector: Gordon M. Stevens  
Drilling Contractor: John Mathes & Associates  
Type of Well: Monitoring  
Static Water Level: Dry Date: 4/1/86  
Measuring Point \*  
Total Depth of Boring: 22.0  
Well Point Depth:  
Drill Casing  
Type: HSA Diameter: 4 1/4" ID  
Length: Material:  
Sampling  
Type: SS Diameter: 2"  
Weight: 140 lbs. Fall: 30"  
Interval: Continuous  
Pipe Left in Place  
Material: SS Diameter: 2"  
Length: 18.5 Joint Type: Flush  
Screen  
Material: SS Diameter: 2"  
Slot Size: 10 Interval: 6.0 - 16.5  
Stratigraphic Unit Screened: garbage  
Packing  
Sand 0 grade Gravel: Natural  
Amount: Interval: 5.0 - 17.0  
Seal  
Type: Bent. Pellets Interval: 2.0 - 5.0  
Bent. Pellets Interval: 17.0 - 22.0  
Locking Casing: Yes  No

**Notes:**

\* Static water level measuring point is top of riser. Well construction depths are from grade.



# MONITORING WELL COMPLETION LOG

**DUNN GEOSCIENCE CORPORATION**  
 5 Northway Lane North  
 Latham, NY 12110  
 518/783-8102

Project: Volney Landfill  
 Client: URS  
 Project #: 553-3-4337  
 Well #: BW - 10D  
 Date Drilled: 1/31/86  
 Date Developed: 2/5/86 - 2/6/86

## CONSTRUCTION DETAIL

WELL DIAGRAM

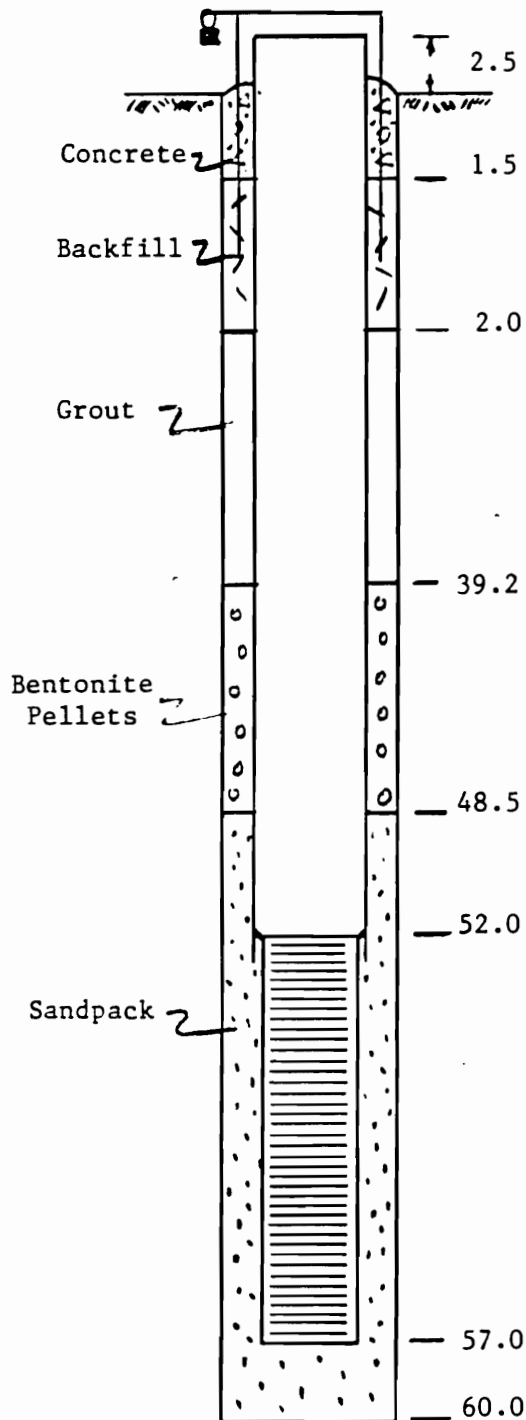

Inspector: Gordon M. Stevens  
 Drilling Contractor: A.W. Kincaid, Inc.  
 Type of Well: Monitoring  
 Static Water Level: 38.94 Date: 4/1/86  
 Measuring Point \*  
 Total Depth of Boring: 60.0  
 Well Point Depth: 52.0  
 Drill Casing  
 Type: Flush Joint Diameter: 8"  
 Length: Material: steel  
 Sampling  
 Type: one grab Diameter:  
 Weight: Fall:  
 Interval: 40'  
 Pipe Left in Place  
 Material: SS Diameter: 2"  
 Length: 59.5 Joint Type: Flush  
 Screen  
 Material: SS Diameter: 2"  
 Slot Size: 10 Interval: 52.0 - 57.0  
 Stratigraphic Unit Screened: Lodgement Till  
 Packing  
 Sand: 0 grade Gravel: Natural  
 Amount: Interval: 48.5 - 60.0  
 Seal  
 Type: Bent. Pellets Interval: 39.2 - 48.5

Locking Casing Yes  No

Notes:

\* Static water level measuring point is top of riser. Well construction depths are from grade.

# MONITORING WELL COMPLETION LOG

## DUNN GEOSCIENCE CORPORATION



5 Northway Lane North  
Latham, NY 12110

518/783-8102

Project: Volney Landfill

Client: URS

Project #: 553-3-4337

Well #: BW-10 Br

Date Drilled: 1/29/86 - 2/8/86

Date Developed: 2/20/86

### CONSTRUCTION DETAIL

#### WELL DIAGRAM

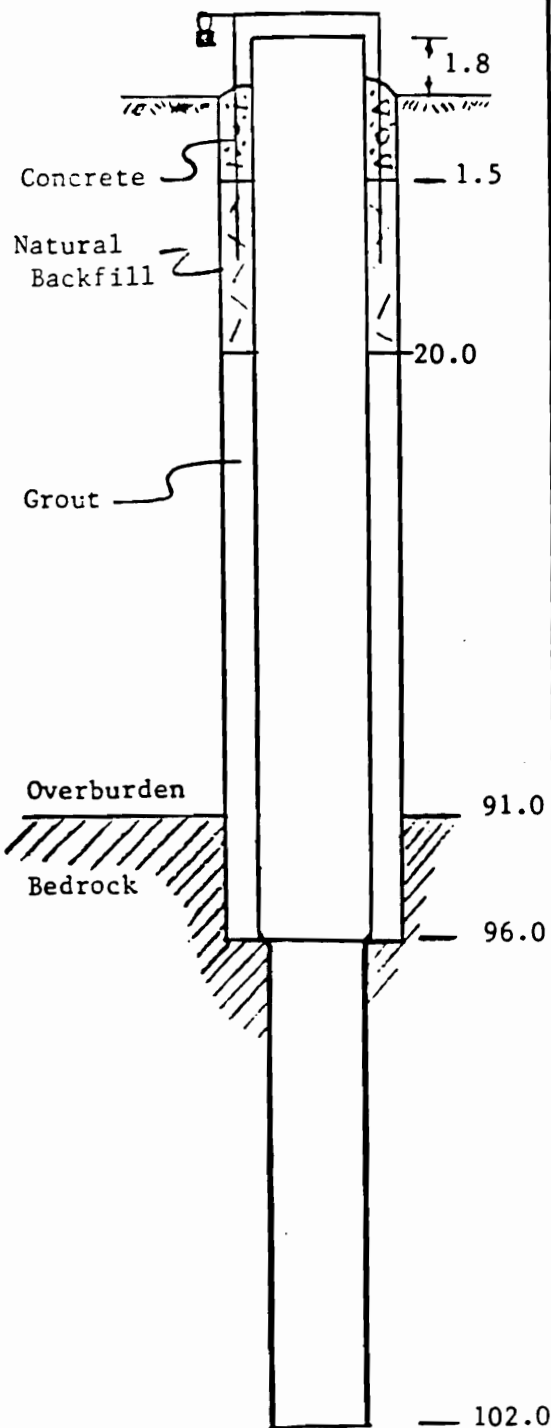

Inspector: Gordon M. Stevens

Drilling Contractor: \*

Type of Well Monitoring

Static Water Level 53.31' Date 4/1/86

Measuring Point \*\*

Total Depth of Boring 102.0'

Well Point Depth 96.0'

Drill Casing

Type Steel Diameter 8"

Sampling

Type Core Diameter 3"

Interval 96.0' - 102.0'

Pipe Left in Place

Material SS Diameter 4"

Length 98.8 Joint Type Flush

Screen

Material Natural Diameter 3"

Interval 96.0' - 102.0'

Stratigraphic Unit Screened sandstone

Rock Socket

Seal

Type grout Interval 91.0' - 96.0'

Locking Casing Yes  No

Notes:

\* Soil boring, rock socket and stainless steel riser installed by A.W. Kincaid, Inc. Rock core and locking well protector installed by John Mathes & Associates.

\*\* Static water level measuring point is top of riser. Well construction depths are measured from grade.

# MONITORING WELL COMPLETION LOG

## DUNN GEOSCIENCE CORPORATION



5 Northway Lane North  
Latham, NY 12110

518/783-8102

Project: Volney Landfill

Client: URS

Project #: 553-3-4337

Well #: BW-11

Date Drilled: 1/22/86

Date Developed: 1/31/86

### CONSTRUCTION DETAIL

#### WELL DIAGRAM

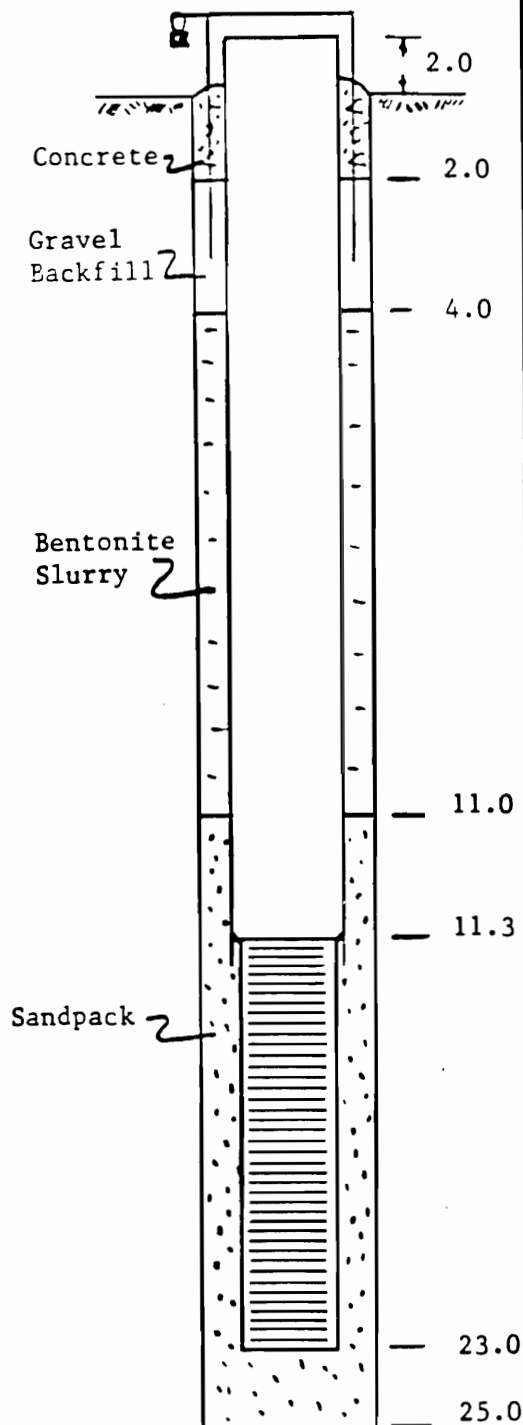

Inspector: Rich Amirault

Drilling Contractor: John Mathes & Associates

Type of Well: Monitoring

Static Water Level: 19.65 Date: 4/1/86

Measuring Point \*

Total Depth of Boring: 25.0

Well Point Depth:

Drill Casing

Type: HSA Diameter: 4 1/4" ID

Length: Material:

Sampling

Type: SS Diameter: 2"

Weight: 140 lbs. Fall: 30"

Interval: Standard

Pipe Left in Place

Material: SS Diameter: 2"

Length: 25.0 Joint Type: Flush

Screen

Material: SS Diameter: 2"

Slot Size: 10 Interval: 11.3 - 23.0

Stratigraphic Unit Screened: sand and gravel

Packing

Sand: 0 grade Gravel: Natural

Amount: Interval: 11.0 - 25

Seal

Type: Bentonite Slurry Interval: 4.0 - 11.0

Locking Casing: Yes  No

Notes:

- \* Static water level measuring point is top of riser. Well construction depths are from grade.

# MONITORING WELL COMPLETION LOG

**DUNN GEOSCIENCE CORPORATION**  
 5 Northway Lane North  
 Latham, NY 12110  
 518/783-8102

Project: Volney Landfill  
 Client: URS  
 Project #: 553-3-4337  
 Well #: BW-12  
 Date Drilled: 1/18/86  
 Date Developed: 2/4/86 - 2/5/86

## CONSTRUCTION DETAIL

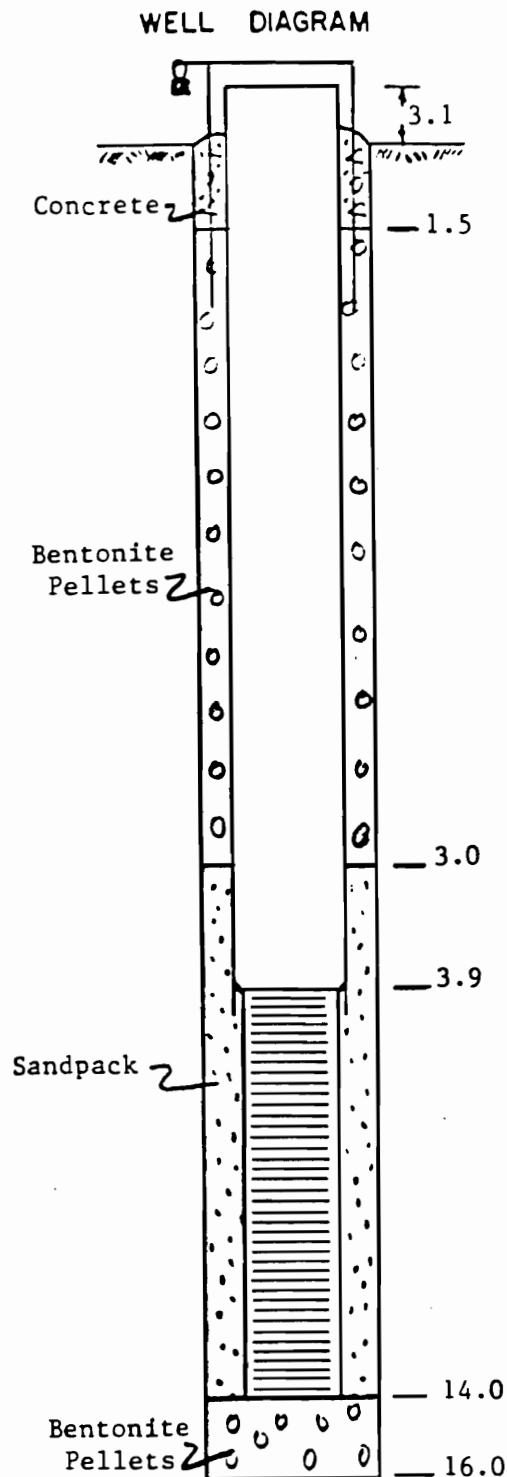

Inspector: Gordon M. Stevens  
 Drilling Contractor: John Mathes & Associates  
 Type of Well Monitoring  
 Static Water Level 14.14 Date 4/1/86  
 Measuring Point \*  
 Total Depth of Boring 16.0  
 Well Point Depth \_\_\_\_\_  
 Drill Casing  
 Type HSA Diameter 4 1/2" ID  
 Length \_\_\_\_\_ Material \_\_\_\_\_  
 Sampling  
 Type SS Diameter 2"  
 Weight 140 lbs. Fall 30"  
 Interval Standard  
 Pipe Left in Place  
 Material SS Diameter 2"  
 Length 17.1 Joint Type Flush  
 Screen  
 Material SS Diameter 2"  
 Slot Size 10 Interval 3.9 - 14.0  
 Stratigraphic Unit Screened sand and gravel  
 Packing  
 Sand 0 grade Gravel \_\_\_\_\_ Natural \_\_\_\_\_  
 Amount \_\_\_\_\_ Interval 3.0 - 14.0  
 Seal  
 Type Bent. Pellets Interval 1.5 - 3.0  
Bent. Pellets 14.0 - 16.0  
 Locking Casing Yes X No \_\_\_\_\_

Notes:

\* Static water level measuring point is top of riser. Well construction depths are from grade.

# MONITORING WELL COMPLETION LOG

## DUNN GEOSCIENCE CORPORATION



5 Northway Lane North  
Latham, NY 12110  
518/783-8102

Project: Volney Landfill

Client: URS

Project #: 553-3-4337

Well #: BW-13

Date Drilled: 1/22/86

Date Developed 2/4/86 - 2/5/86

### CONSTRUCTION DETAIL

#### WELL DIAGRAM

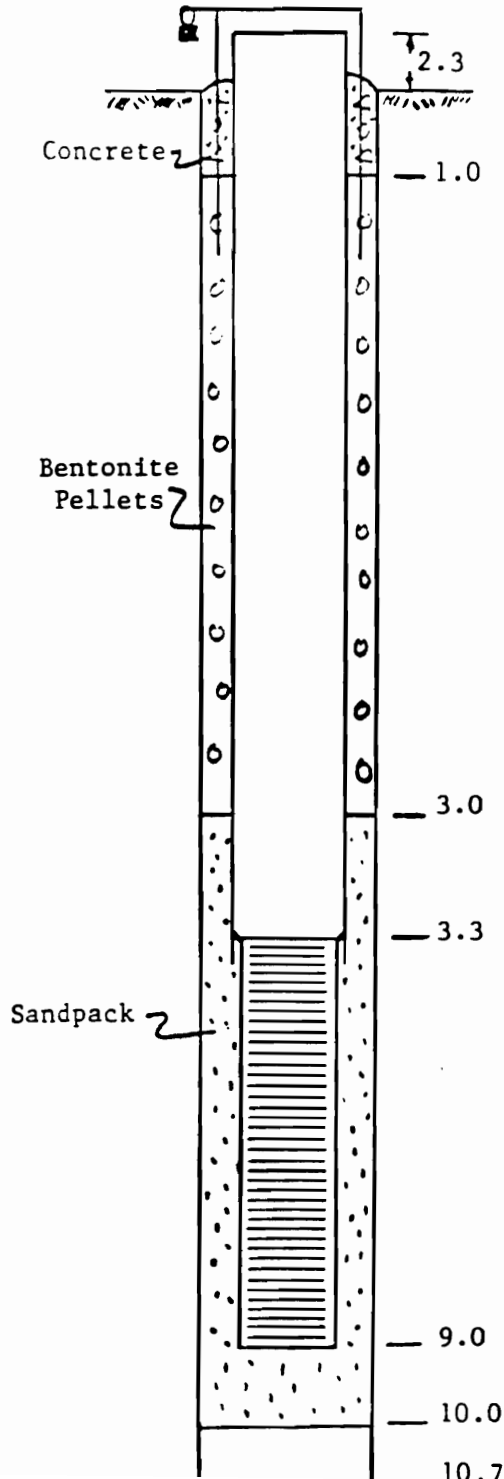

Inspector: Rich Amirault

Drilling Contractor: John Mathes & Associates

Type of Well: Monitoring

Static Water Level: 3.54 Date: 4/1/86

Measuring Point \*

Total Depth of Boring: 10.0

Well Point Depth:

Drill Casing

Type: HSA Diameter: 4 1/4" ID

Length: Material:

Sampling

Type: SS Diameter: 2"

Weight: 140 lbs. Fall: 30"

Interval: Standard

Pipe Left in Place

Material: SS Diameter: 2"

Length: 11.3 Joint Type: Flush

Screen

Material: SS Diameter: 2"

Slot Size: 10 Interval: 3.3 - 9.0

Stratigraphic Unit Screened: Lodgement till

Packing

Sand: 0 grade Gravel: Natural

Amount: Interval: 3.0 - 10.0

Seal

Type: Bent. Pellets Interval: 1.0 - 3.0

Locking Casing: Yes  No

Notes:

- \* Static water level measuring point is top of riser. Well construction depths are from grade.

# MONITORING WELL COMPLETION LOG

## DUNN GEOSCIENCE CORPORATION



5 Northway Lane North  
Latham, NY 12110  
518/783-8102

Project: Volney Landfill  
Client: URS  
Project #: 553-3-4337  
Well #: BW-14  
Date Drilled: 1/22/86  
Date Developed: 1/29/86

### CONSTRUCTION DETAIL

#### WELL DIAGRAM

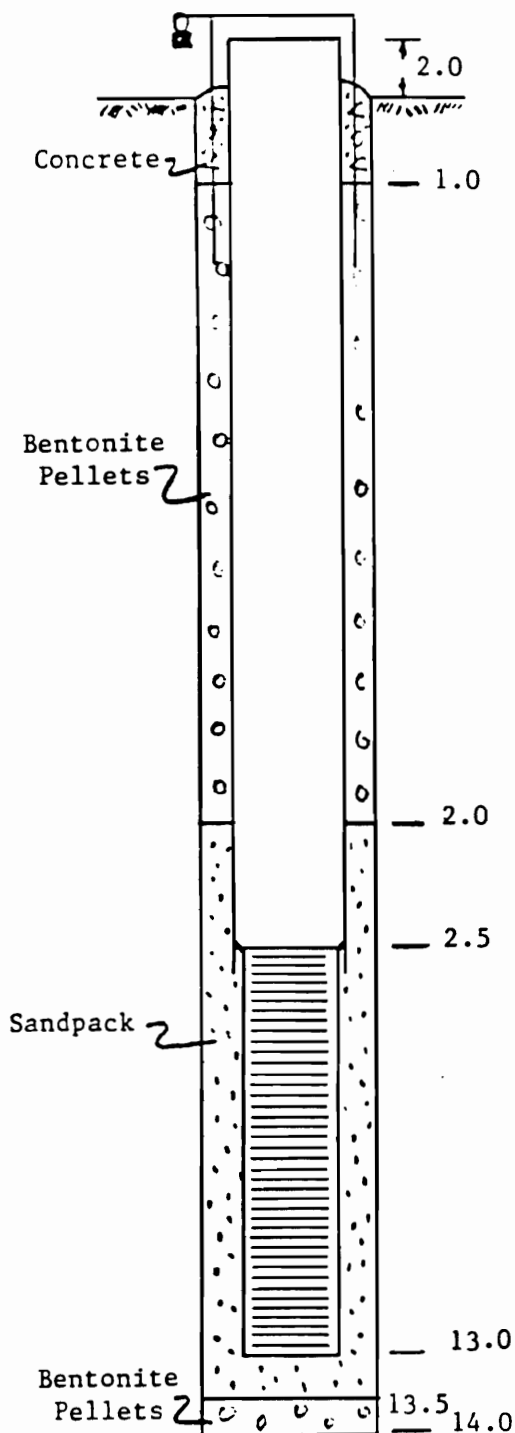

Inspector: Gordon M. Stevens  
Drilling Contractor: John Mathes & Associates  
Type of Well: Monitoring  
Static Water Level: 4.23 Date: 4/1/86  
Measuring Point \*  
Total Depth of Boring: 14.0  
Well Point Depth: \_\_\_\_\_  
Drill Casing  
Type: HSA Diameter: 4 1/2" ID  
Length: \_\_\_\_\_ Material: \_\_\_\_\_  
Sampling  
Type: SS Diameter: 2"  
Weight: 140 lbs. Fall: 30"  
Interval: Standard  
Pipe Left in Place  
Material: SS Diameter: 2"  
Length: 15.0 Joint Type: Flush  
Screen  
Material: SS Diameter: 2"  
Slot Size: 10 Interval: 2.5 - 13.0  
Stratigraphic Unit Screened: fine sand  
Packing  
Sand 0 grade Gravel: \_\_\_\_\_ Natural: \_\_\_\_\_  
Amount: \_\_\_\_\_ Interval: 2.0 - 13.5  
Seal  
Type: Bent. Pellets Interval: 1.0 - 2.0  
Bent. Pellets Interval: 13.5 - 14.0  
Locking Casing: Yes  No \_\_\_\_\_

#### Notes:

\* Static water level measuring point is top of riser. Well construction depths are from grade.

# MONITORING WELL COMPLETION LOG

## DUNN GEOSCIENCE CORPORATION



5 Northway Lane North  
Latham, NY 12110  
518/783-8102

Project: Volney Landfill

Client: URS

Project #: 553-3-4337

Well #: BW-15

Date Drilled: 1/17/86

Date Developed: 1/31/86

### CONSTRUCTION DETAIL

WELL DIAGRAM

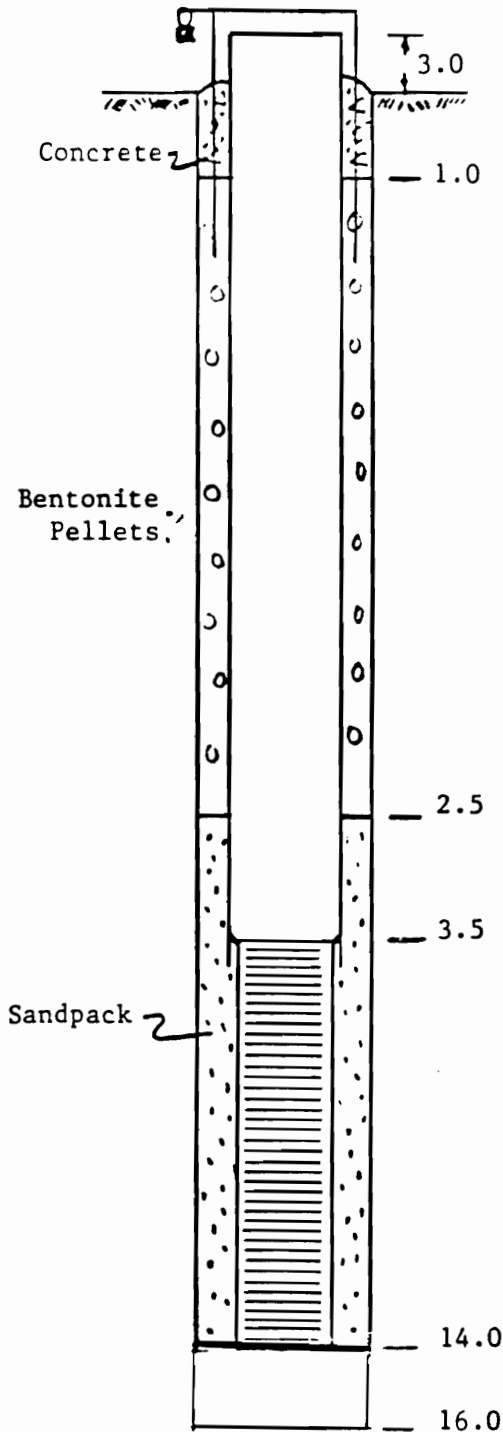

Inspector: Gordon M. Stevens

Drilling Contractor: John Mathes & Associates

Type of Well: Monitoring

Static Water Level: 7.06 Date: 4/1/86

Measuring Point \*

Total Depth of Boring: 14.0

Well Point Depth:

Drill Casing

Type: HSA Diameter: 4 1/4" ID

Length: Material:

Sampling

Type: SS Diameter: 2"

Weight: 140 lbs. Fall: 30"

Interval: Standard

Pipe Left in Place

Material: SS Diameter: 2"

Length: 17.0 Joint Type: Flush

Screen

Material: SS Diameter: 2"

Slot Size: 10 Interval: 3.5 - 14.0

Stratigraphic Unit Screened: sand

Packing

Sand: 0 grade Gravel: Natural

Amount: Interval: 2.5 - 14.0

Seal

Type: Bent. Pellets Interval: 1.0 - 2.5

Locking Casing: Yes  No

Notes:

\* Static water level measuring point is top of riser. Well construction depths are from grade.

# MONITORING WELL COMPLETION LOG

## DUNN GEOSCIENCE CORPORATION



5 Northway Lane North  
Latham, NY 12110  
518/783-8102

Project: Volney Landfill  
Client: URS  
Project #: 553-3-4337  
Well #: BW-16  
Date Drilled: 2/7/86  
Date Developed: 2/20/86

### CONSTRUCTION DETAIL

#### WELL DIAGRAM

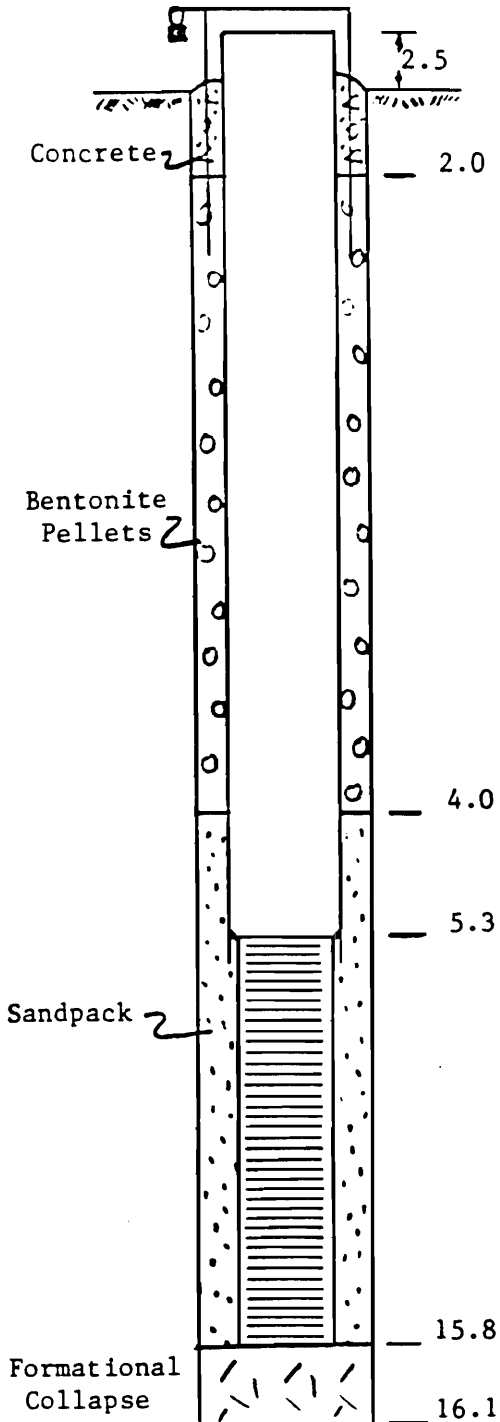

Inspector: Gordon M. Stevens  
Drilling Contractor: John Mathes & Associates  
Type of Well: Monitoring  
Static Water Level: 4.70 Date: 4/1/86  
Measuring Point \*  
Total Depth of Boring: 16.1  
Well Point Depth:  
Drill Casing:  
Type: HSA Diameter: 4 1/4" ID  
Length: Material:  
Sampling:  
Type: SS Diameter: 2"  
Weight: 140 lbs. Fall: 30"  
Interval: Standard  
Pipe Left in Place:  
Material: SS Diameter: 2"  
Length: 18.3 Joint Type: Flush  
Screen:  
Material: SS Diameter: 2"  
Slot Size: 10 Interval: 5.3 - 15.8  
Stratigraphic Unit Screened: sand and gravel  
Packing:  
Sand: 0 grade Gravel: Natural  
Amount: Interval: 4.0 - 15.8  
Seal:  
Type: Bent. Pellet Interval: 2.0 - 4.0  
Locking Casing: Yes  No

#### Notes:

\* Static water level measuring point is top of riser. Well construction depths are from grade.

On Niagara Mohawk Property



# MONITORING WELL COMPLETION LOG

## DUNN GEOSCIENCE CORPORATION



5 Northway Lane North  
Latham, NY 12110  
518/783-8102

Project: Volney Landfill

Client: URS

Project #: 553-3-4337

Well #: BW-17

Date Drilled: 1/17/86 - 1/18/86

Date Developed: 1/30/86 - 1/31/86

### CONSTRUCTION DETAIL

#### WELL DIAGRAM

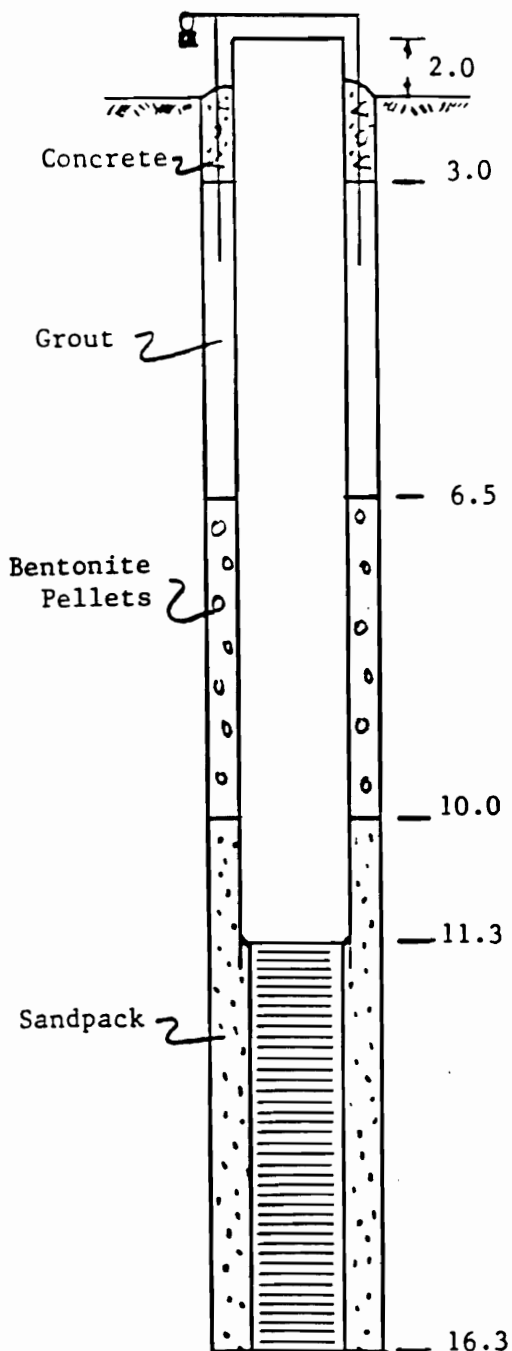

Inspector: Gordon M. Stevens  
 Drilling Contractor: John Mathes & Associates  
 Type of Well: Monitoring  
 Static Water Level: 5.41 Date: 4/1/86  
 Measuring Point \*  
 Total Depth of Boring: 16.3  
 Well Point Depth:  
 Drill Casing:  
 Type: HSA Diameter: 4 1/2" ID  
 Length: Material:  
 Sampling:  
 Type: SS Diameter: 2"  
 Weight: 140 lbs. Fall: 30"  
 Interval: Standard  
 Pipe Left in Place:  
 Material: SS Diameter: 2"  
 Length: 18.3 Joint Type: Flush  
 Screen:  
 Material: SS Diameter: 2"  
 Slot Size: 10 Interval: 11.3 - 16.3  
 Stratigraphic Unit Screened: Lodgement Till  
 Packing:  
 Sand: 0 grade Gravel: Natural  
 Amount: Interval: 10.0 - 16.3  
 Seal:  
 Type: Bent. Pellets Interval: 6.5 - 10.0  
 Locking Casing: Yes  No

#### Notes:

- \* Static water level measuring point is top of riser. Well construction depths are from grade.

# MONITORING WELL COMPLETION LOG

## DUNN GEOSCIENCE CORPORATION



5 Northway Lane North  
Latham, NY 12110  
518/783-8102

Project: Volney Landfill  
Client: URS  
Project #: 553-3-4337  
Well #: BW-17a  
Date Drilled: 1/18/86  
Date Developed: 1/30/86 - 1/31/86

### CONSTRUCTION DETAIL

WELL DIAGRAM

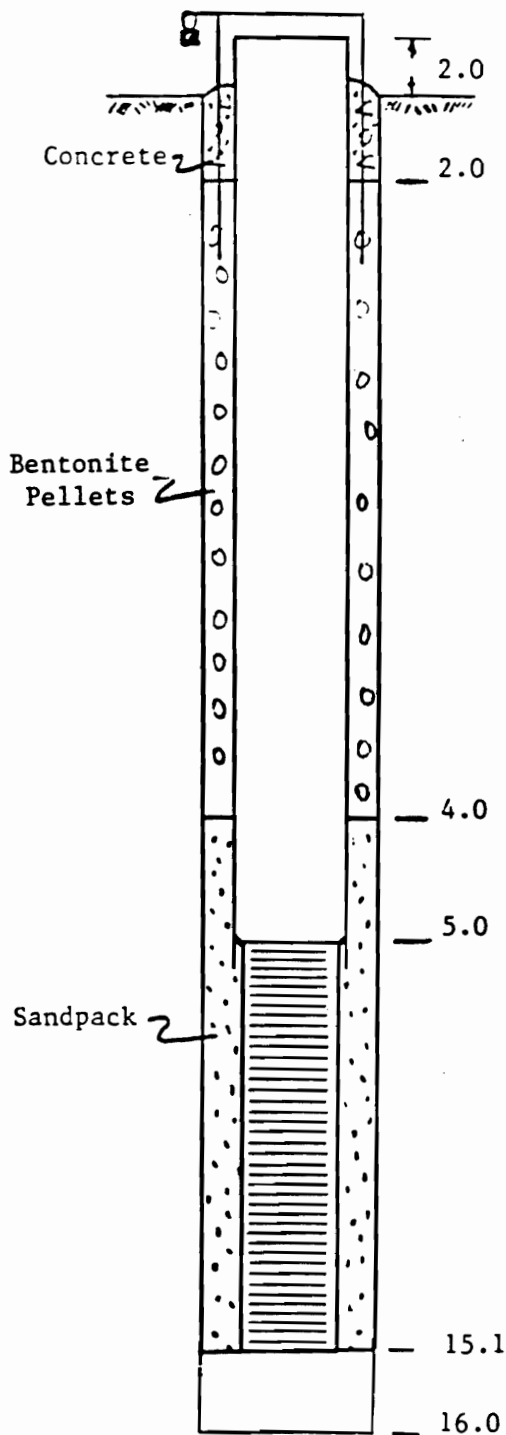

Inspector: Gordon M. Stevens  
Drilling Contractor: John Mathes & Associates  
Type of Well: Monitoring  
Static Water Level: 4.53 Date: 4/1/86  
Measuring Point \*  
Total Depth of Boring: 15.1  
Well Point Depth:  
Drill Casing  
Type: HSA Diameter: 4 1/2" ID  
Length: Material:  
Sampling  
Type: SS Diameter: 2"  
Weight: 140 lbs. Fall: 30"  
Interval: Standard  
Pipe Left in Place  
Material: SS Diameter: 2"  
Length: 17.1 Joint Type: Flush  
Screen  
Material: SS Diameter: 2"  
Slot Size: 10 Interval: 5.0 - 15.1  
Stratigraphic Unit Screened: sand, gravel, clay  
Packing  
Sand: 0 grade Gravel: Natural  
Amount: Interval: 4.0 - 15.1  
Seal  
Type: Bent. Pellets Interval: 2.0 - 4.0  
Locking Casing Yes  No

Notes:

\* Static water level measuring point is top of riser. Well construction depths are from grade.

APPENDIX C  
Rock Core Logs

# Dunn Geoscience Corporation

## Core Log

Client URS  
 Project Volney Landfill  
553-3-4337  
 Location \_\_\_\_\_

Logged by Gordon M. Stevens Date Logged 2/8/86  
 Drilling Co. John Mathes & Associates  
 Driller Chuck Vous  
 Started 9:15a 2/8/86 Finished 10:15a 2/8/86

Hole BW-3 br  
 Depth 86.0 - 92.2  
 Elev. 473.70  
 Core Dia. NX

Member	Zone/Unit	Graphic Log 1" = 5'	Depth	Descriptive Log	Angle of Bedding to Core	% Core Recovery
			86	<p style="text-align: center;">TOP OF CORE: 86.0'</p> <p>Run 1: 86.0' - 92.2' Penetration = 6.2' Rec. = 4.3' % Rec. = 69% RQD = 16%</p> <p><b>SANDSTONE:</b> Dark reddish brown (10 R 3/4). Fine grained massive, horizontal bedding with occasional small scale crossbedding; occasional small clasts of Dark reddish brown clay/shale. Numerous breaks or fractures along bedding surfaces.</p> <p style="text-align: center;">D-1, S-2 to S-3, F-3 to F-4</p>	0°	69%
			92	<p style="text-align: center;">BOTTOM OF CORE 92.2'</p>		

# Dunn Geoscience Corporation

## Core Log

URS  
 Volney Landfill  
 553-3-4337  
 \_\_\_\_\_  
 \_\_\_\_\_  
 \_\_\_\_\_  
 \_\_\_\_\_  
 \_\_\_\_\_  
 \_\_\_\_\_

Logged by Gordon M. Stevens Date Logged 2/6/86  
 Drilling Co. John Mathes and Associates  
 Driller Chuck Vous  
 Started 2:15p 2/6/86 Finished 3:00p 2/6/86

Hole BW-8 br  
 Depth 51.5' - 56.5'  
 Elev. 461.08  
 Core Dia. NX

Zone/Unit	Graphic Log 1" = 5'	Depth	Descriptive Log	Angle of Bedding to Core	% Core Recovery
		50			
		52			
		54		0°	70%
		56			
		58			

**Descriptive Log**

ROCK TYPE: color; grain size; texture; bedding; minerals; remarks, etc.

TOP OF CORE: 51.5'

Run 1: 51.5' - 56.5' Penetration = 5.0' Rec. = 3.5' % Rec. = 70% % RQD = 0  
 SANDSTONE: Dark reddish brown (10R 3/4). Fine grained massive, horizontal bedding with occasional small scale crossbedding; occasional lenses of Greenish gray (5 G4 6/1) Sandstone; occasional clasts of Dark reddish brown Clay/shale. Numerous breaks or fractures along bedding surfaces.

BOTTOM OF CORE: 56.5'

D-1, S-2 to S-3, F-3 to F-4

# Dunn Geoscience Corporation

## Core Log

URS  
 Volney Landfill  
 553-3-4337

Logged by Gordon M. Stevens Date Logged 2/8/86  
 Drilling Co. John Mathes and Associates  
 Driller Chuck Vous  
 Started 1:00p 2/8/86 Finished 2:30p 2/8/86

Hole BW-10 br  
 Depth 96.0' - 102.0'  
 Elev. 492.98'  
 Core Dia. NX

Zone/Unit	Graphic Log 1" = 5'	Depth	Descriptive Log	Angle of Bedding to Core	% Core Recovery
		96	<p>TOP OF CORE: 96.0'</p> <p>Run 1: 96.0'-102.0' Penetration = 6.0' Rec. = 0.6' %Rec. = 10% RQD = 0%</p>		
		98	<p><u>SANDSTONE</u>: Dark reddish brown (10 R 3/4). Fine grained massive, horizontal bedding occasional clasts of Dark reddish brown clay/shale. <u>Numerous breaks or fractures</u> along bedding surfaces.</p> <p style="text-align: center;">D-1, S-2 to S-3, F-4 to F-5</p>	0°	10%
		100			
		102	<p>BOTTOM OF CORE: 102.0'</p>		

ROCK TYPE: color, grain size, texture; bedding; minerals; remarks, etc.

APPENDIX D

Monitoring Well Installation Reports

# MONITORING WELL COMPLETION LOG

## DUNN GEOSCIENCE CORPORATION



5 Northway Lane North  
Latham, NY 12110  
518/783-8102

Project: Volney Landfill  
Client: URS  
Project #: 553-3-4337  
Well #: BW-1  
Date Drilled: 1/18/86 - 1/19/86  
Date Developed: 2/4/86

### CONSTRUCTION DETAIL

#### WELL DIAGRAM

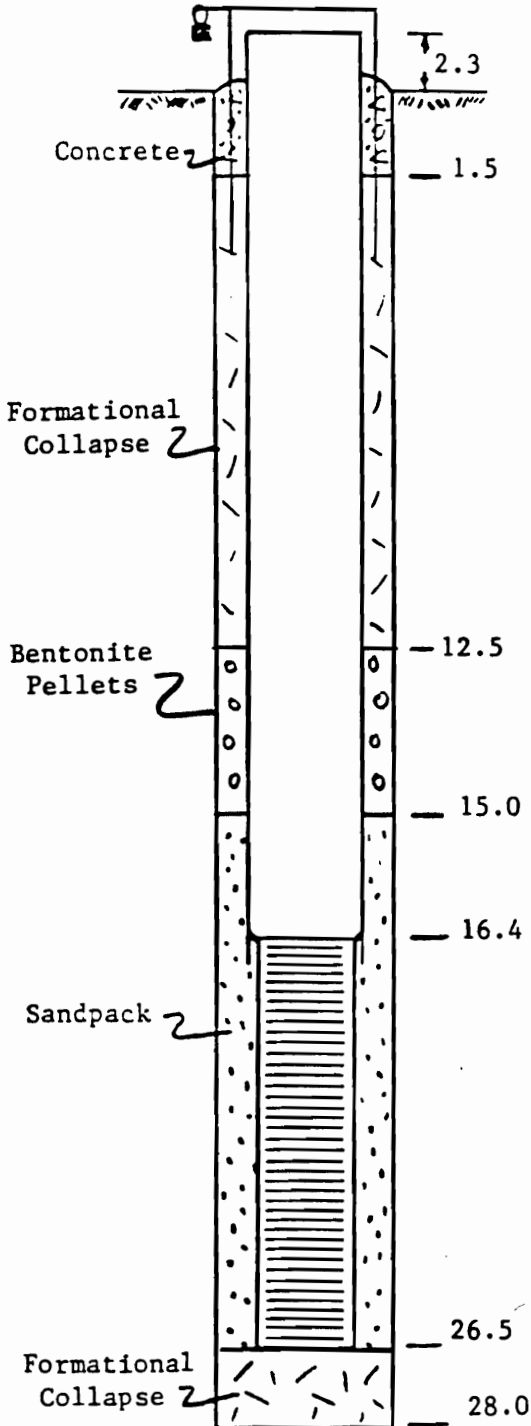

Inspector: Gordon M. Stevens  
Drilling Contractor: John Mathes & Associates  
Type of Well: Monitoring  
Static Water Level: 20.54 Date: 4/1/86  
Measuring Point: \*  
Total Depth of Boring: 28.0  
Well Point Depth: \_\_\_\_\_  
Drill Casing  
Type: HSA Diameter: 4 1/4" ID  
Length: \_\_\_\_\_ Material: \_\_\_\_\_  
Sampling  
Type: SS Diameter: 2"  
Weight: 140 lbs. Fall: 30"  
Interval: Standard  
Pipe Left in Place  
Material: SS Diameter: 2"  
Length: 30.3 Joint Type: Flush  
Screen  
Material: SS Diameter: 2"  
Slot Size: 10 Interval: 16.4 - 26.5  
Stratigraphic Unit Screened: sand & gravel  
Packing  
Sand: 0 grade Gravel: \_\_\_\_\_ Natural: \_\_\_\_\_  
Amount: \_\_\_\_\_ Interval: 15.0 - 26.5  
Seal  
Type: Bent. Pellets Interval: 12.5 - 15.0  
Locking Casing: Yes  No \_\_\_\_\_

Notes:

\* Static water level measuring point is top of riser. Well construction depths are from grade.



# MONITORING WELL COMPLETION LOG

## DUNN GEOSCIENCE CORPORATION



5 Northway Lane North  
Latham, NY 12110  
518/783-8102

Project: Volney Landfill  
Client: URS  
Project #: 553-3-4337  
Well #: BW-2  
Date Drilled: 1/21/86  
Date Developed: 2/4/86

### CONSTRUCTION DETAIL

#### WELL DIAGRAM

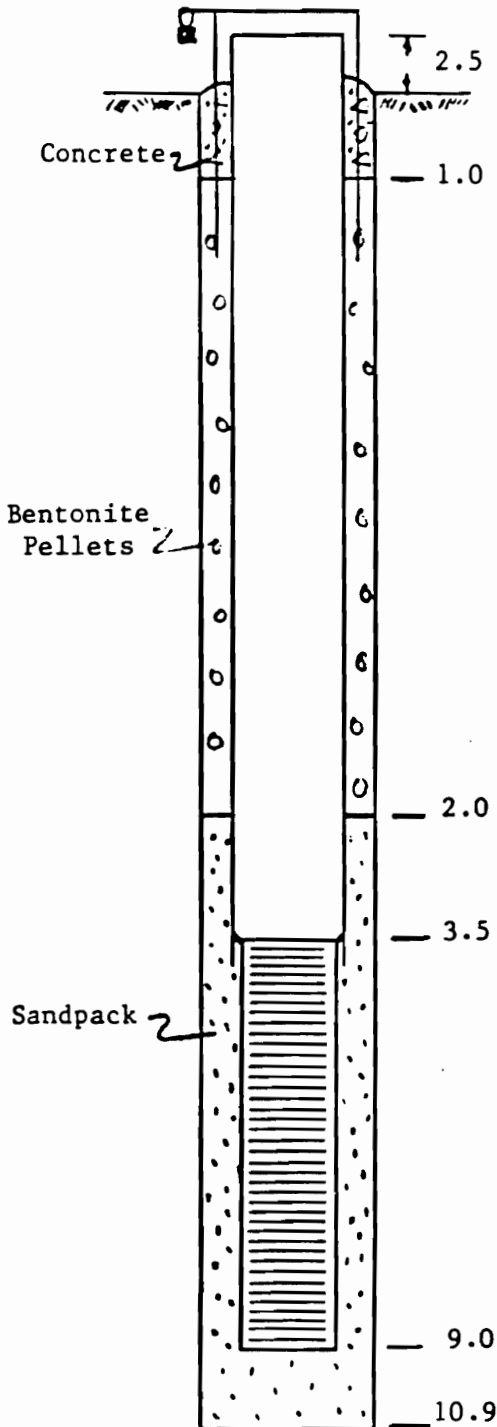

Inspector: Rich Amirault  
Drilling Contractor: John Mathes & Associates  
Type of Well: Monitoring  
Static Water Level: 8.62 Date: 4/1/86  
Measuring Point \*  
Total Depth of Boring: 10.0  
Well Point Depth: 3.5  
Drill Casing  
Type: HSA Diameter: 4 1/4" ID  
Length: Material:  
Sampling  
Type: SS Diameter: 2"  
Weight: 140 lbs. Fall: 30"  
Interval: Standard  
Pipe Left in Place  
Material: SS Diameter: 2"  
Length: 11.5 Joint Type: Flush  
Screen  
Material: SS Diameter: 2"  
Slot Size: 10 Interval: 3.5 - 9.0  
Stratigraphic Unit Screened: Fill  
Packing  
Sand: 0 grade Gravel: Natural  
Amount: Interval: 2.0 - 10.0  
Seal  
Type: Bent. Pellets Interval: 1.0 - 2.0

Locking Casing Yes  No

#### Notes:

\* Static water level measuring point is top of riser. Well construction depths are from grade.

# MONITORING WELL COMPLETION LOG

## DUNN GEOSCIENCE CORPORATION



5 Northway Lane North  
Latham, NY 12110  
518/783-8102

Project: Volney Landfill

Client: URS

Project #: 553-3-4337

Well #: BW - 3S

Date Drilled: 1/21/86

Date Developed: 3/5/86

### CONSTRUCTION DETAIL

#### WELL DIAGRAM

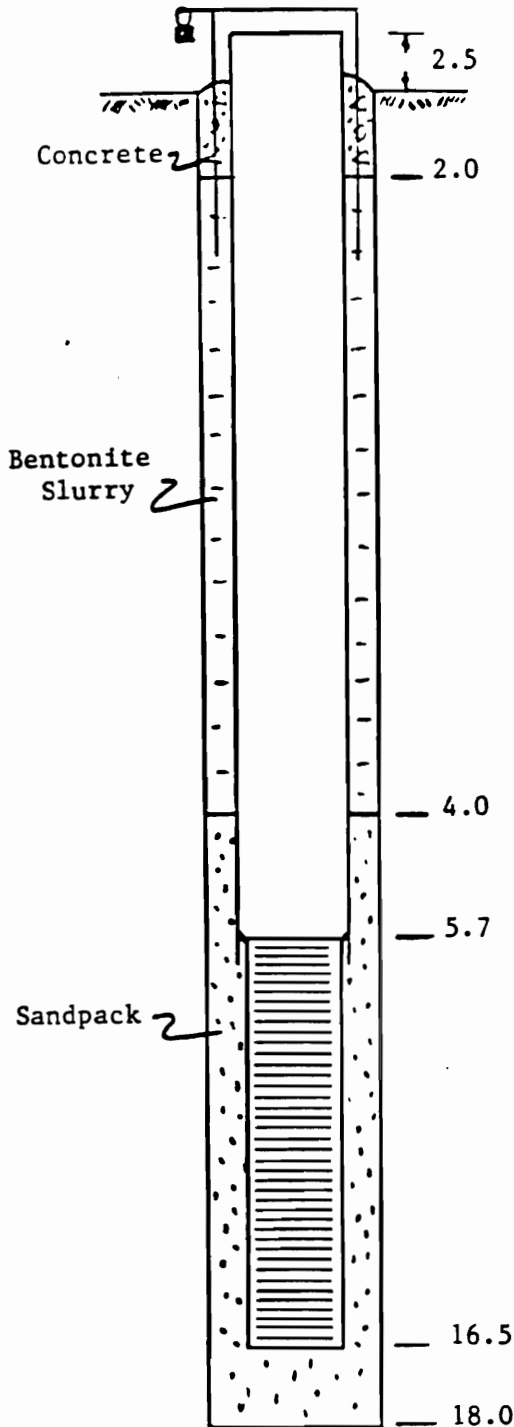

Inspector: Rich Amirault

Drilling Contractor: John Mathes & Associates

Type of Well: Monitoring

Static Water Level: 4.87 Date: 4/1/86

Measuring Point \*

Total Depth of Boring: 18.0

Well Point Depth: 5.7

Drill Casings

Type: HSA Diameter: 4 1/4" ID

Length: Material:

Sampling

Type: No Samples Diameter:

Weight: Fall:

Interval:

Pipe Left in Place

Material: SS Diameter: 2"

Length: 19.0 Joint Type: Flush

Screen

Material: SS Diameter: 2"

Slot Size: 10 Interval: 5.7 - 16.5

Stratigraphic Unit Screened: sand and gravel

Packing

Sand: 0 grade Gravel: Natural

Amount: Interval: 4.0 - 18.0

Seal

Type: Bentonite Slurry Interval: 2.0 - 4.0

Locking Casings: Yes  No

Notes:

- \* Static water level measuring point is top of riser. Well construction depths are from grade.

# MONITORING WELL COMPLETION LOG

## DUNN GEOSCIENCE CORPORATION



5 Northway Lane North  
Latham, NY 12110

518/783-8102

Project: Volney Landfill

Client: URS

Project #: 553-3-4337

Well #: BW-3I

Date Drilled: 1/20/86

Date Developed: 2/5/86

### CONSTRUCTION DETAIL

#### WELL DIAGRAM

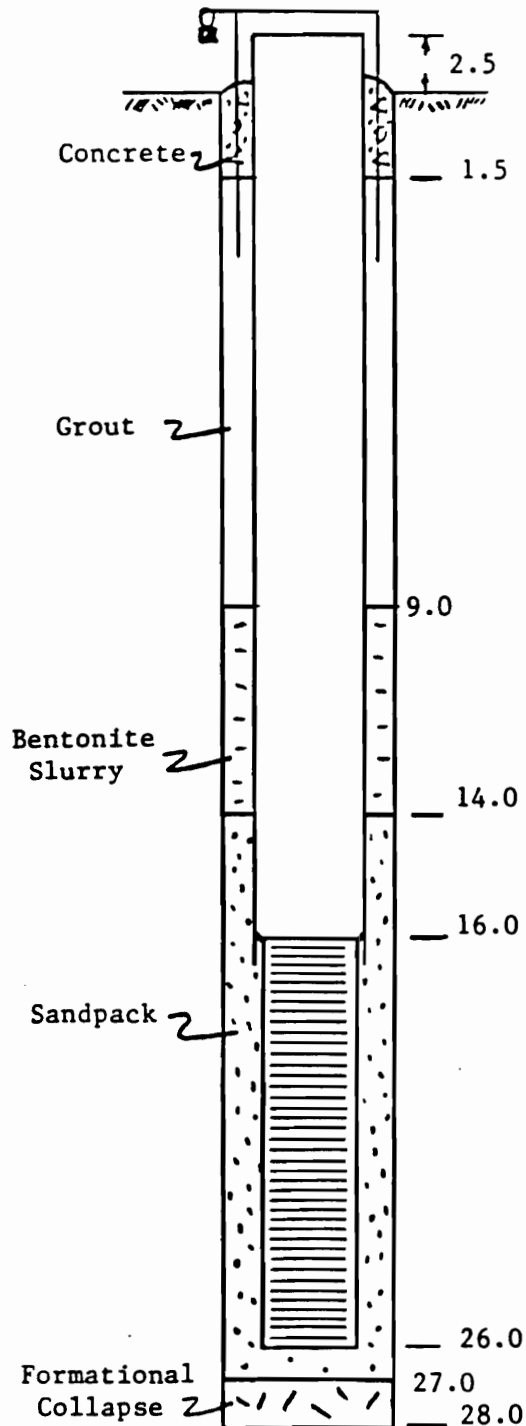

Inspector: Hal Hatfield

Drilling Contractor: John Mathes & Associates

Type of Well Monitoring

Static Water Level 4.98 Date 4/1/86

Measuring Point \*

Total Depth of Boring 28.0

Well Point Depth 16.0

Drill Casing

Type HSA Diameter 4 1/4" ID

Length Material

Sampling

Type No Samples Diameter

Weight Fall

Interval

Pipe Left in Place

Material SS Diameter 2"

Length 28.5 Joint Type Flush

Screen

Material SS Diameter 2"

Slot Size 10 Interval 16.0 - 26.0

Stratigraphic Unit Screened sand and gravel

Packing

Sand 0 grade Gravel Natural

Amount 1 bag Interval 14.0 - 27.0

Seal

Type Bentonite Slurry Interval 9.0 - 14.0

Locking Casing Yes  No

Notes:

\* Static water level measuring point is top of riser. Well construction depths are from grade.

# MONITORING WELL COMPLETION LOG

## DUNN GEOSCIENCE CORPORATION



5 Northway Lane North  
Latham, NY 12110  
518/783-8102

Project: Volney Landfill  
Client: URS  
Project #: 553-3-4337  
Well #: BW-3D  
Date Drilled: 1/18/86  
Date Developed: 2/5/86

### CONSTRUCTION DETAIL

#### WELL DIAGRAM

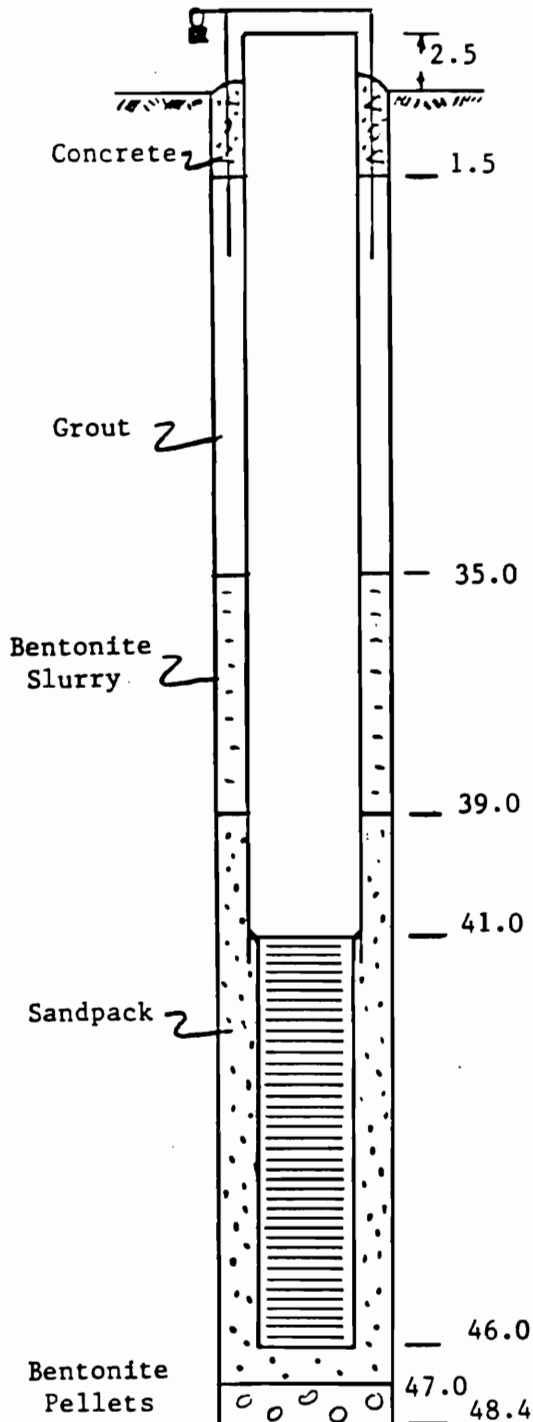

Inspector: Hal Hatfield  
Drilling Contractor: John Mathes & Associates  
Type of Well: Monitoring  
Static Water Level: 4.74 Date: 4/1/86  
Measuring Point \*  
Total Depth of Boring: 48.4'  
Well Point Depth: 41.0'  
Drill Casing  
Type: HSA Diameter: 4 1/4" ID  
Length: Material:  
Sampling  
Type: SS Diameter: 2"  
Weight: 140 lbs. Fall: 30"  
Interval: Continuous  
Pipe Left in Place  
Material: SS Diameter: 2"  
Length: 48.5' Joint Type: Flush  
Screen  
Material: SS Diameter: 2"  
Slot Size: 10 Interval: 41.0 - 46.0  
Stratigraphic Unit Screened: Lodgement Till  
Packing  
Sand: 0 grade Gravel: Natural  
Amount: 2 bags Interval: 39.0 - 47.0  
Seal  
Type: Bentonite Slurry Interval: 35.0 - 39.0  
Bentonite Pellets Interval: 47.0 - 48.4  
Locking Casing: Yes  No

#### Notes:

\* Static water level measuring point is top of riser. Well construction depths are from grade.

# MONITORING WELL COMPLETION LOG

## DUNN GEOSCIENCE CORPORATION



5 Northway Lane North  
Latham, NY 12110

518/783-8102

Project: Volney Landfill

Client: URS

Project #: 553-3-4337

Well #: BW-3 Br

Date Drilled: 1/23/86 - 2/8/86

Date Developed: 2/20/86

### CONSTRUCTION DETAIL

#### WELL DIAGRAM

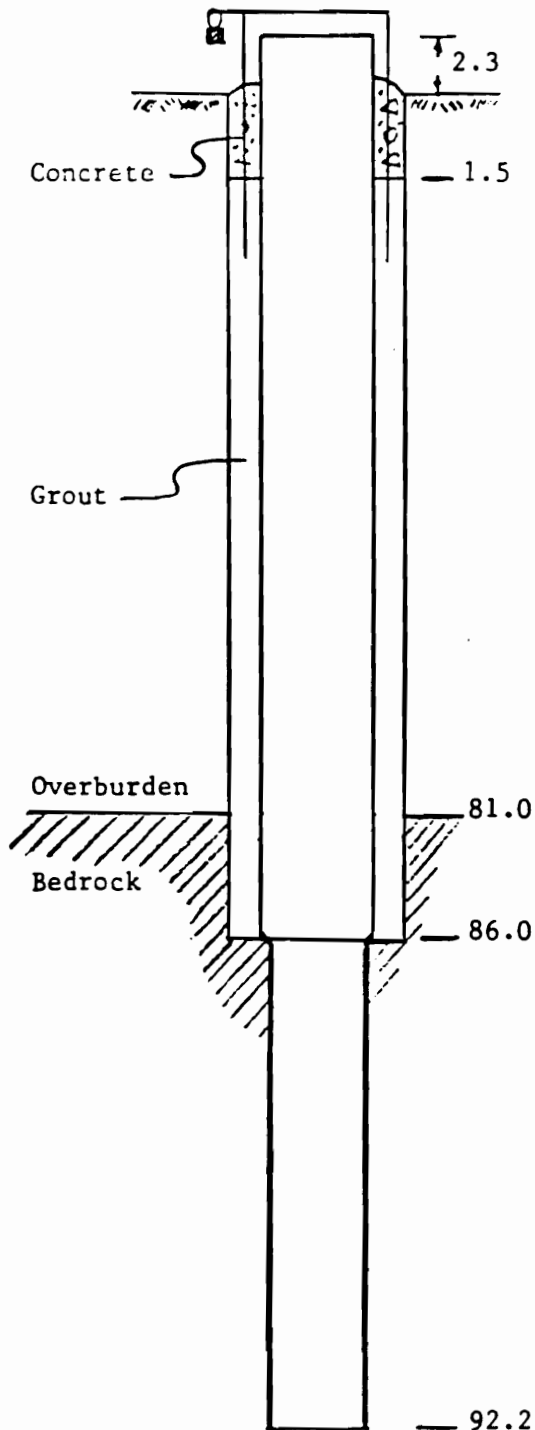

Inspector: Gordon M. Stevens

Drilling Contractor: \*

Type of Well Monitoring

Static Water Level 4.58' Date 4/1/86

Measuring Point \*\*

Total Depth of Boring 92.2'

Well Point Depth 86.0'

Drill Casing

Type Steel Diameter 8"

Sampling

Type Core Diameter 3"

Interval 86.0' - 92.2'

Pipe Left in Place

Material SS Diameter 4"

Length 88.3' Joint Type Flush

Screen

Material Natural Diameter 3"

Interval 86.0' - 92.3'

Stratigraphic Unit Screened sandstone

Rock Socket

Seal

Type grout Interval 81.0' - 86.0'

Locking Casing Yes  No

Notes:

\* Soil boring, rock socket and stainless steel riser installed by A.W. Kincaid, Inc. Rock core and locking well protector installed by John Mathes & Associates.

\*\* Static water level measuring point is top of riser. Well construction depths are measured from grade.

# MONITORING WELL COMPLETION LOG

## DUNN GEOSCIENCE CORPORATION



5 Northway Lane North  
Latham, NY 12110  
518/783-8102

Project: Volney Landfill

Client: URS

Project #: 553-3-4337

Well #: BW-4S

Date Drilled: 1/16/86

Date Developed: 2/7/86

### CONSTRUCTION DETAIL

#### WELL DIAGRAM

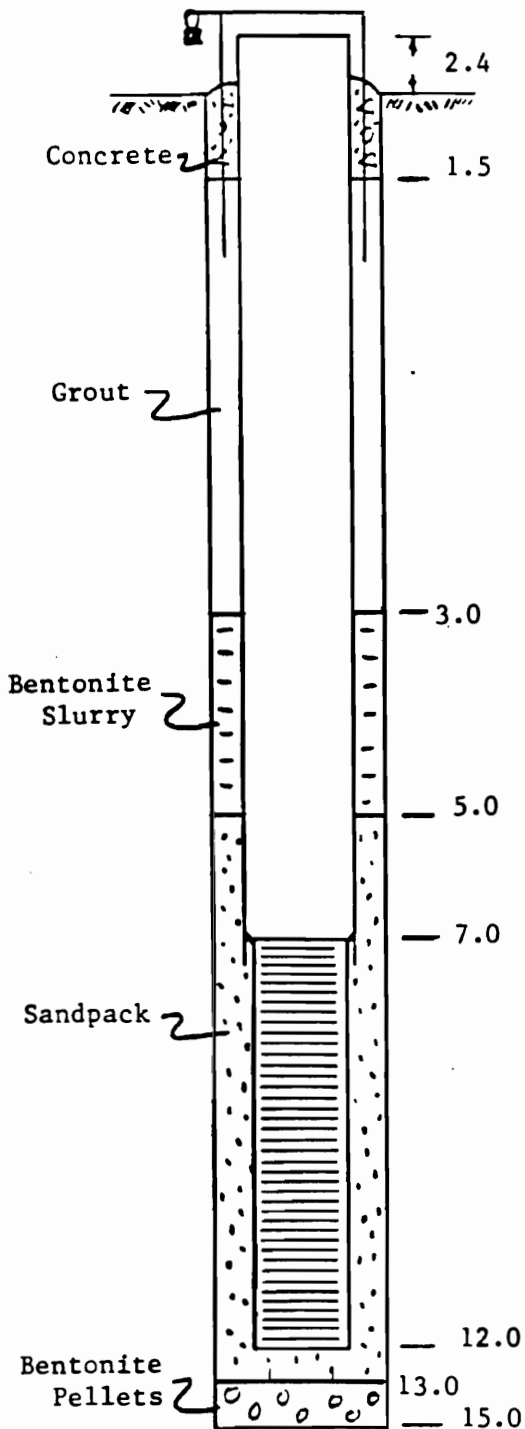

Inspector: Hal Hatfield

Drilling Contractor: John Mathes & Associates

Type of Well: Monitoring

Static Water Level: 9.82 Date: 4/1/86

Measuring Point \*

Total Depth of Boring: 15.0

Well Point Depth:

Drill Casing

Type: HSA Diameter: 4 1/4" ID

Length: Material:

Sampling

Type: SS Diameter: 2"

Weight: 140 lbs. Fall: 30"

Interval: None

Pipe Left in Place

Material: SS Diameter: 2"

Length: 14.4 Joint Type: Flush

Screen

Material: SS Diameter: 2"

Slot Size: 10 Interval: 7.0 - 12.0

Stratigraphic Unit Screened: sand and gravel

Packing

Sand: 0 grade Gravel: Natural

Amount: 2 bags Interval: 5.0 - 13.0

Seal

Type: Bentonite Slurry Interval: 3.0 - 5.0

Bentonite Pellets Interval: 13.0 - 15.0

Locking Casing: Yes  No

Notes:

\* Static water level measuring point is top of riser. Well construction depths are from grade.

# MONITORING WELL COMPLETION LOG

## DUNN GEOSCIENCE CORPORATION



5 Northway Lane North  
Latham, NY 12110  
518/783-8102

Project: Volney Landfill

Client: URS

Project #: 553-3-4337

Well #: BW-4D

Date Drilled: 1/16/86

Date Developed: 2/7/86

### CONSTRUCTION DETAIL

#### WELL DIAGRAM

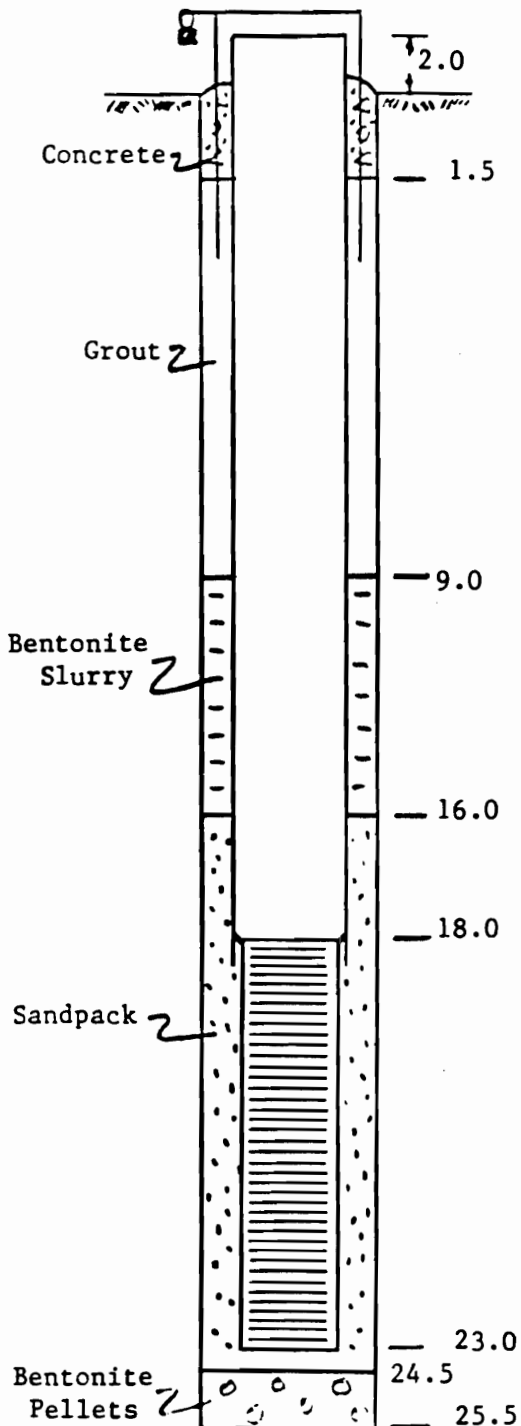

Inspector: Hal Hatfield

Drilling Contractor: John Mathes & Associates

Type of Well: Monitoring

Static Water Level: 10.2 Date: 4/1/86

Measuring Point \*

Total Depth of Boring: 25.5

Well Point Depth:

Drill Casing:

Type: HSA Diameter: 4 1/4" ID

Length: Material:

Sampling:

Type: SS Diameter: 2"

Weight: 140 lbs. Fall: 30"

Interval Standard:

Pipe Left in Place:

Material: SS Diameter: 2"

Length: 25.0 Joint Type: Flush

Screen:

Material: SS Diameter: 2"

Slot Size: 10 Interval: 18.0 - 23.0

Stratigraphic Unit Screened: Lodgement Till

Packing:

Sand 0 grade Gravel: Natural

Amount: 2 1/2 bags Interval: 16.0 - 25.5

Seal:

Type: Bentonite Slurry Interval: 9.0 - 16.0

Bentonite Pellets: 24.5 - 25.5

Locking Casing: Yes  No

Notes:

\* Static water level measuring point is top of riser. Well construction depths are from grade.

# MONITORING WELL COMPLETION LOG

**DUNN GEOSCIENCE CORPORATION**  
 5 Northway Lane North  
 Latham, NY 12110  
 518/783-8102

Project: Volney Landfill  
 Client: URS  
 Project #: 553-3-4337  
 Well #: RW-5  
 Date Drilled: 1/17/86  
 Date Developed: 2/6/86 - 2/7/86

## CONSTRUCTION DETAIL

WELL DIAGRAM

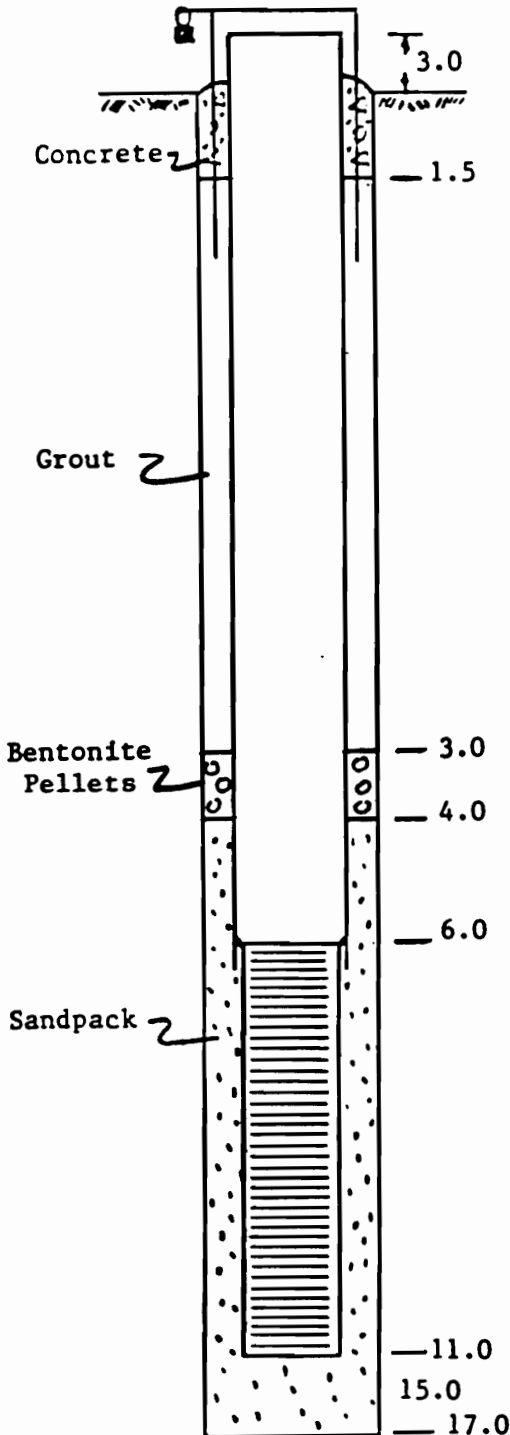

Inspector: Hal Hatfield  
 Drilling Contractor: John Mathes & Associates  
 Type of Well Monitoring  
 Static Water Level 4.31 Date 4/1/86  
 Measuring Point \*  
 Total Depth of Boring 17.0  
 Well Point Depth \_\_\_\_\_  
 Drill Casing  
 Type HSA Diameter 4 1/2" ID  
 Length \_\_\_\_\_ Material \_\_\_\_\_  
 Sampling  
 Type SS Diameter 2"  
 Weight 140 lbs. Fall 30"  
 Interval Standard  
 Pipe Left in Place  
 Material SS Diameter 2"  
 Length 14.0 Joint Type Flush  
 Screen  
 Material SS Diameter 2"  
 Slot Size 10 Interval 6.0 - 11.0  
 Stratigraphic Unit Screened fine sand and silt  
 Packing  
 Sand 0 grade Gravel \_\_\_\_\_ Natural \_\_\_\_\_  
 Amount 4 bags Interval 4.0 - 15.0  
 Seal  
 Type Bent. Pellets Interval 3.0 - 4.0  
Bentonite Pellets 15.0 - 17.0  
 Locking Casing Yes X No \_\_\_\_\_

Notes:

\* Static water level measuring point is top of riser. Well construction depths are from grade.



# MONITORING WELL COMPLETION LOG

## DUNN GEOSCIENCE CORPORATION



5 Northway Lane North  
Latham, NY 12110

518/783-8102

Project: Volney Landfill

Client: URS

Project #: 553-3-4337

Well #: BW-6

Date Drilled: 1/17/86

Date Developed: 2/6/86

### CONSTRUCTION DETAIL

#### WELL DIAGRAM

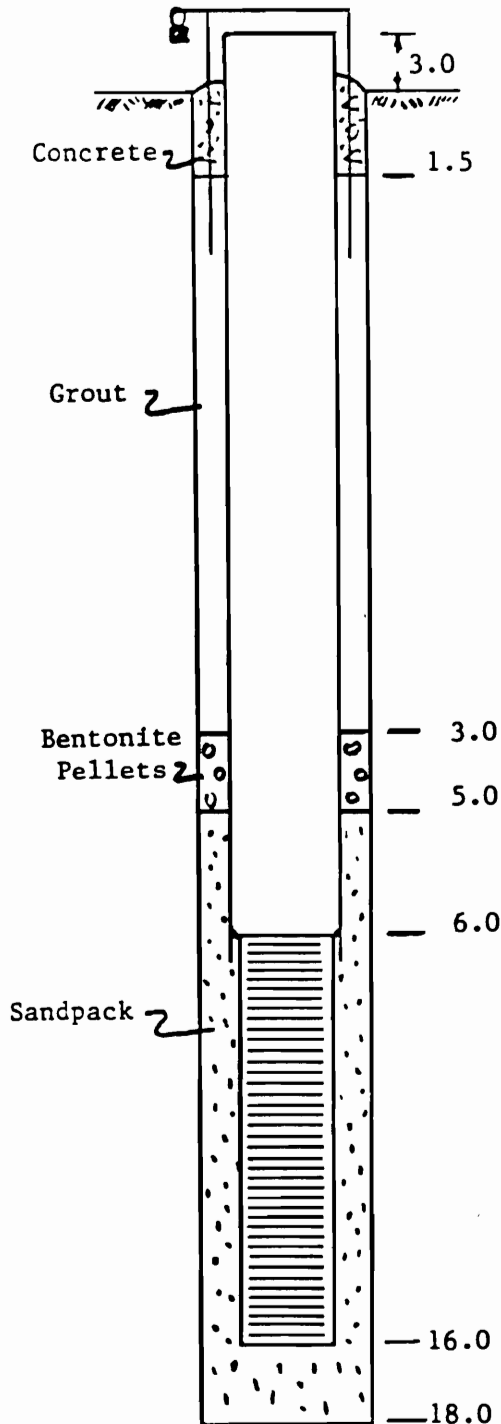

Inspector: Hal Hatfield

Drilling Contractor: John Mathes & Associates

Type of Well: Monitoring

Static Water Level: 4.76 Date: 4/1/86

Measuring Point \*

Total Depth of Boring: 18.0

Well Point Depth:

Drill Casing

Type: HSA Diameter: 4 1/4" ID

Length: Material:

Sampling

Type: SS Diameter: 2"

Weight: 140 lbs. Fall: 30"

Interval: Standard

Pipe Left in Place

Material: SS Diameter: 2"

Length: 19.0 Joint Type: Flush

Screen

Material: SS Diameter: 2"

Slot Size: 10 Interval: 6.0 - 16.0

Stratigraphic Unit Screened: sand and gravel

Packing

Sand: 0 grade Gravel: Natural

Amount: 5 1/2 bags Interval: 5.0 - 18.0

Seal

Type: Bent. Pellets Interval: 3.0 - 5.0

Locking Casing: Yes  No

Notes:

\* Static water level measuring point is top of riser. Well construction depths are from grade.

# MONITORING WELL COMPLETION LOG

## DUNN GEOSCIENCE CORPORATION



5 Northway Lane North  
Latham, NY 12110

518/783-8102

Project: Volney Landfill

Client: URS

Project #: 553-3-4337

Well #: BW - 7S

Date Drilled: 1/19/86 - 1/20/86

Date Developed: 1/29/86 - 1/30/86

### CONSTRUCTION DETAIL

#### WELL DIAGRAM

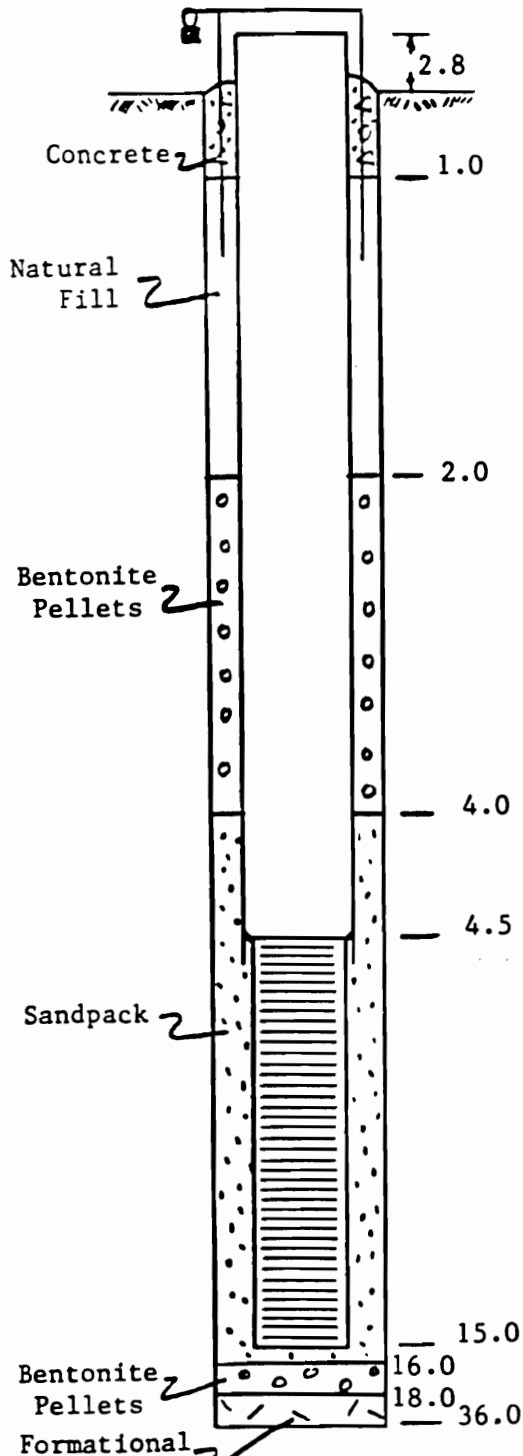

Inspector: Gordon M. Stevens  
 Drilling Contractor: John Mathes & Associates  
 Type of Well: Monitoring  
 Static Water Level: 5.60 Date: 4/1/86  
 Measuring Point: \*  
 Total Depth of Boring: 36.0  
 Well Point Depth: \_\_\_\_\_  
 Drill Casing  
 Type: HSA Diameter: 4 1/4" ID  
 Length: \_\_\_\_\_ Material: \_\_\_\_\_  
 Sampling  
 Type: SS Diameter: 2"  
 Weight: 140 lbs. Fall: 30"  
 Interval: Standard  
 Pipe Left in Place  
 Material: SS Diameter: 2"  
 Length: 17.8 Joint Type: Flush  
 Screen  
 Material: SS Diameter: 2"  
 Slot Size: 10 Interval: 4.5 - 15.0  
 Stratigraphic Unit Screened: sand and gravel  
 Packing  
 Sand: 0 grade Gravel: \_\_\_\_\_ Natural: \_\_\_\_\_  
 Amount: \_\_\_\_\_ Interval: 4.0 - 16.0  
 Seal  
 Type: Bent. Pellets Interval: 2.0 - 4.0  
 Bent. Pellets Interval: 16.0 - 18.0  
 Locking Casing: Yes  No

Notes:

\* Static water level measuring point is top of riser. Well construction depths are from grade.

# MONITORING WELL COMPLETION LOG

## DUNN GEOSCIENCE CORPORATION



5 Northway Lane North  
Latham, NY 12110

518/783-8102

Project: Volney Landfill

Client: URS

Project #: 553-3-4337

Well #: BW - 7D

Date Drilled: 1/22/86

Date Developed: 1/29/86

### CONSTRUCTION DETAIL

#### WELL DIAGRAM

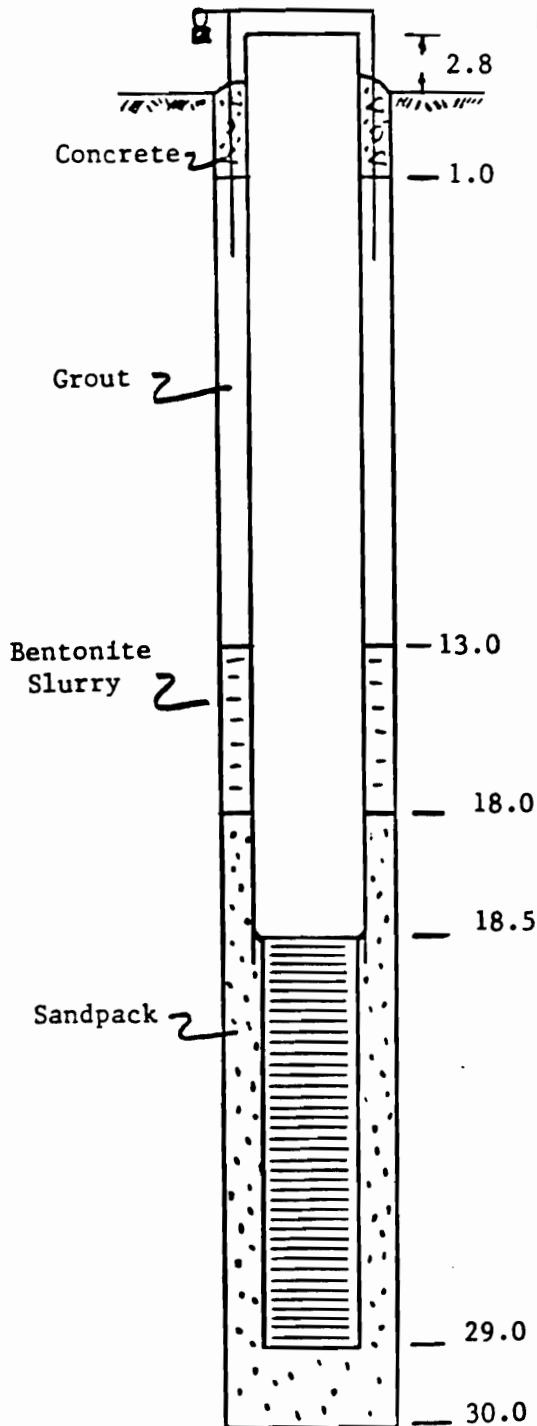

Inspector: Gordon M. Stevens

Drilling Contractor: John Mathes & Associates

Type of Well: Monitoring

Static Water Level: 4.91 Date: 4/1/86

Measuring Point \*

Total Depth of Boring: 30.0

Well Point Depth: 18.5

Drill Casing

Type: HSA Diameter: 4 1/4" ID

Length: Material:

Sampling

Type: No Samples Diameter:

Weight: Fall:

Interval:

Pipe Left in Place

Material: SS Diameter: 2"

Length: 31.8 Joint Type: Flush

Screen

Material: SS Diameter: 2"

Slot Size: 10 Interval: 18.5 - 29.0

Stratigraphic Unit Screened: fine sand & silt

Packing

Sand: 0 grade Gravel: Natural

Amount: Interval: 18.0 - 30.0

Seal

Type: Bentonite Slurry Interval: 13.0 - 18.0

Locking Casing: Yes  No

Notes:

- \* Static water level measuring point is top of riser. Well construction depths are from grade.

APPENDIX E  
Physical Analyses of Soils

# Dunn Geoscience Laboratory

5 Northway Lane North, Latham, NY 12110 (518) 783-8102

CLIENT: URS (VOLNEY)  
 LAB NUMBER: 86-3-77/553-3-4337 DATE RECEIVED: 3/12/86  
 TEST BY: JWH DATE TESTED: 3/26/86  
 REVIEWED BY: *MJJ* DATE REPORTED: 4/7/86  
 SAMPLE DESCR: BW-3, S-19, 36' - 38'

## GRAIN SIZE DISTRIBUTION

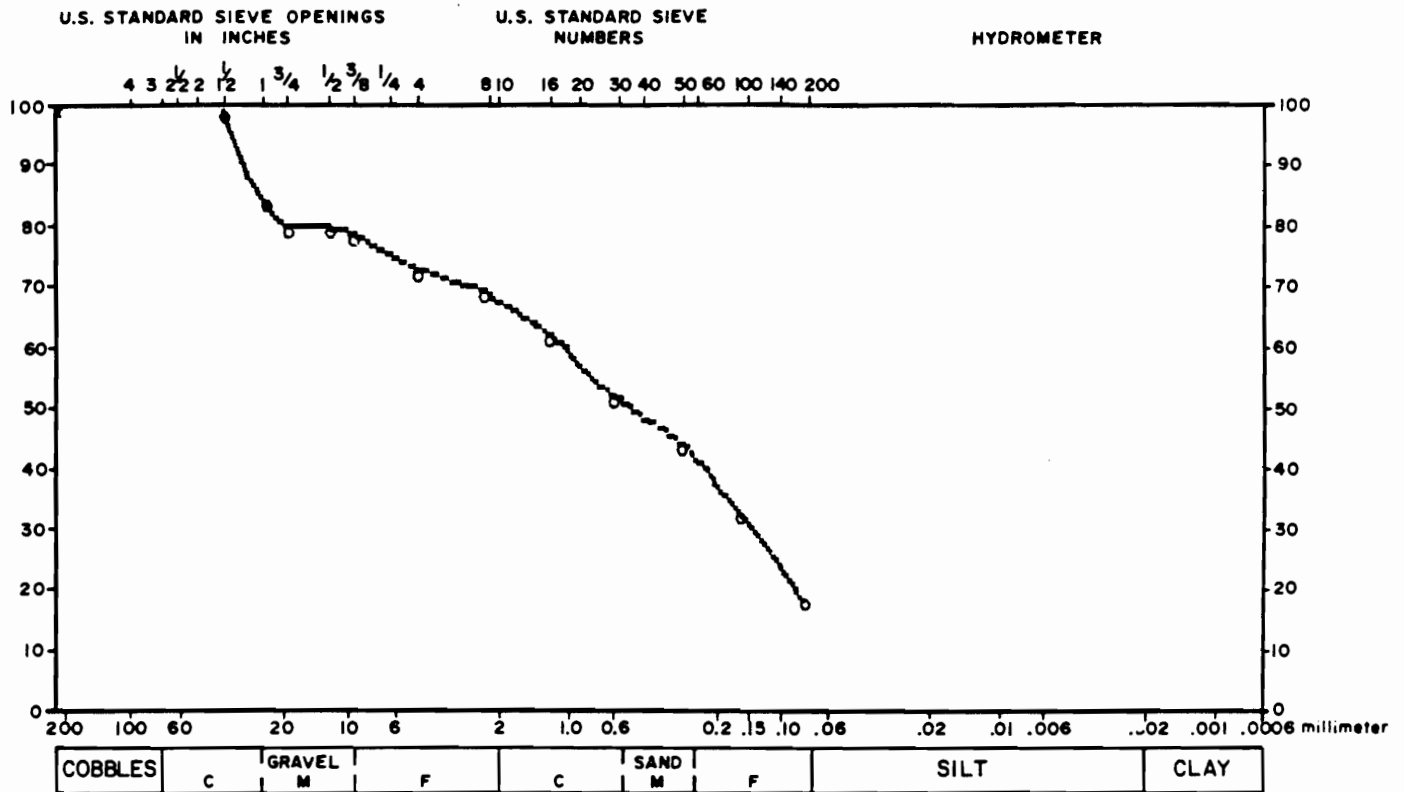

COARSE				FINE				HYDROMETER		
SIZE (Inches)	PERCENT RETAINED	CUMULATIVE PERCENT PASSING	SPECS.	SIEVE	PERCENT RETAINED	CUMULATIVE PERCENT PASSING	SPECS.	PARTICLE DIAMETER (mm)	PERCENT PASSING	SPECS.
1.5	0.00	100.00	-	4	5.94	73.63	-			
1	14.40	85.60	-	8	3.84	69.79	-			
3/4	5.11	80.49	-	16	6.84	62.96	-			
1/2	0.00	80.49	-	30	10.02	52.93	-			
3/8	.92	79.57	-	50	8.05	44.88	-			
-	0.00	0.00	-	100	11.29	33.59	-			
-	0.00	0.00	-	200	14.67	18.91	-			
-	0.00	0.00	-	-	0.00	0.00	-			
-	0.00	0.00	-	-	0.00	0.00	-			
-	0.00	0.00	-	-	0.00	0.00	-			
-	0.00	0.00	-	-	0.00	0.00	-			
-	0.00	0.00	-	-	0.00	0.00	-			

PAN = 18.9%  
 WASH LOSS WAS NOT TESTED.

SPECIFICATION: ASTM C 136      ASTM D 2216

TEST STANDARD: NONE

NOTES:                      MOISTURE - 6.30%

Test samples are retained for 30 days after submission and then discarded, unless other arrangements are made.

*Handwritten note:*  
 Directly mounted  
 between  
 200 and 40  
 ?

# Dunn Geoscience Laboratory

5 Northway Lane North, Latham, NY 12110 (518) 783-8102

CLIENT: URS (VOLNEY)  
 LAB NUMBER: 86-3-84/553-3-4337 DATE RECEIVED: 3/12/86  
 TEST BY: JWH DATE TESTED: 3/26/86  
 REVIEWED BY: *MJS* DATE REPORTED: 4/7/86  
 SAMPLE DESCR: BW-3, S-21, 40' - 42'

## GRAIN SIZE DISTRIBUTION

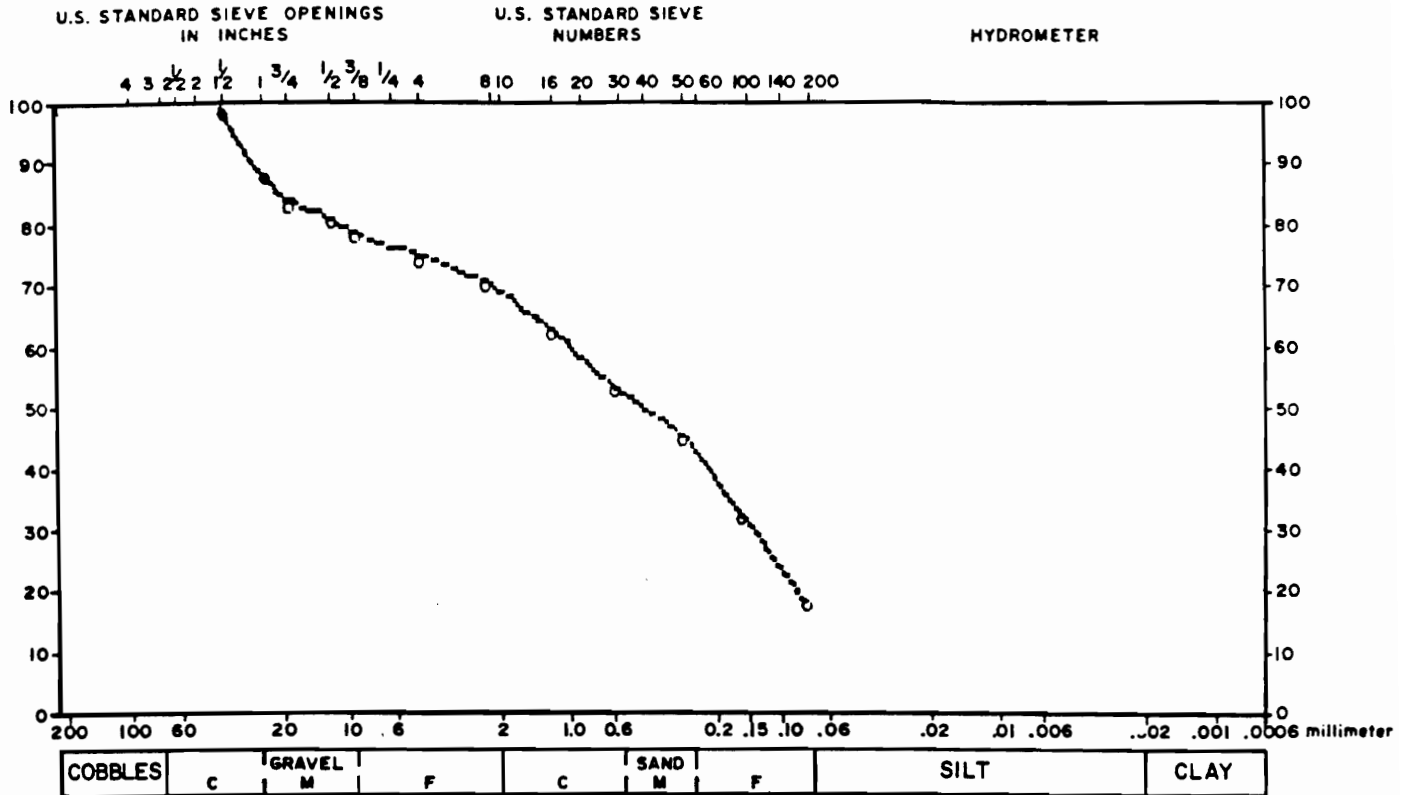

COARSE				FINE				HYDROMETER		
SIZE (Inches)	PERCENT RETAINED	CUMULATIVE PERCENT PASSING	SPECS.	SIEVE	PERCENT RETAINED	CUMULATIVE PERCENT PASSING	SPECS.	PARTICLE DIAMETER (mm)	PERCENT PASSING	SPECS.
1.5	0.00	100.00	-	4	3.87	75.61	-			
1	10.71	89.29	-	8	4.23	71.38	-			
3/4	4.39	84.90	-	16	7.85	63.54	-			
1/2	3.02	81.88	-	30	9.65	53.88	-			
3/8	2.40	79.48	-	50	7.72	46.17	-			
-	0.00	0.00	-	100	12.54	33.63	-			
-	0.00	0.00	-	200	15.12	18.50	-			
-	0.00	0.00	-	-	0.00	0.00	-			
-	0.00	0.00	-	-	0.00	0.00	-			
-	0.00	0.00	-	-	0.00	0.00	-			
-	0.00	0.00	-	-	0.00	0.00	-			
-	0.00	0.00	-	-	0.00	0.00	-			

PAN = 18.5%  
 WASH LOSS WAS NOT TESTED.

SPECIFICATION: ASTM C 136      ASTM D 2216  
 TEST STANDARD: NONE  
 NOTES:      MOISTURE - 6.86%  
 Test samples are retained for 30 days after submission and then discarded, unless other arrangements are made.

# Dunn Geoscience Laboratory

5 Northway Lane North, Latham, NY 12110 (518) 783-8102

CLIENT: URS (VOLNEY)  
 LAB NUMBER: 86-3-85/553-3-4337 DATE RECEIVED: 3/12/86  
 TEST BY: JWH DATE TESTED: 3/26/86  
 REVIEWED BY: *MJS* DATE REPORTED: 4/7/86  
 SAMPLE DESCR: BW-3, S-22, 42' - 44'

## GRAIN SIZE DISTRIBUTION

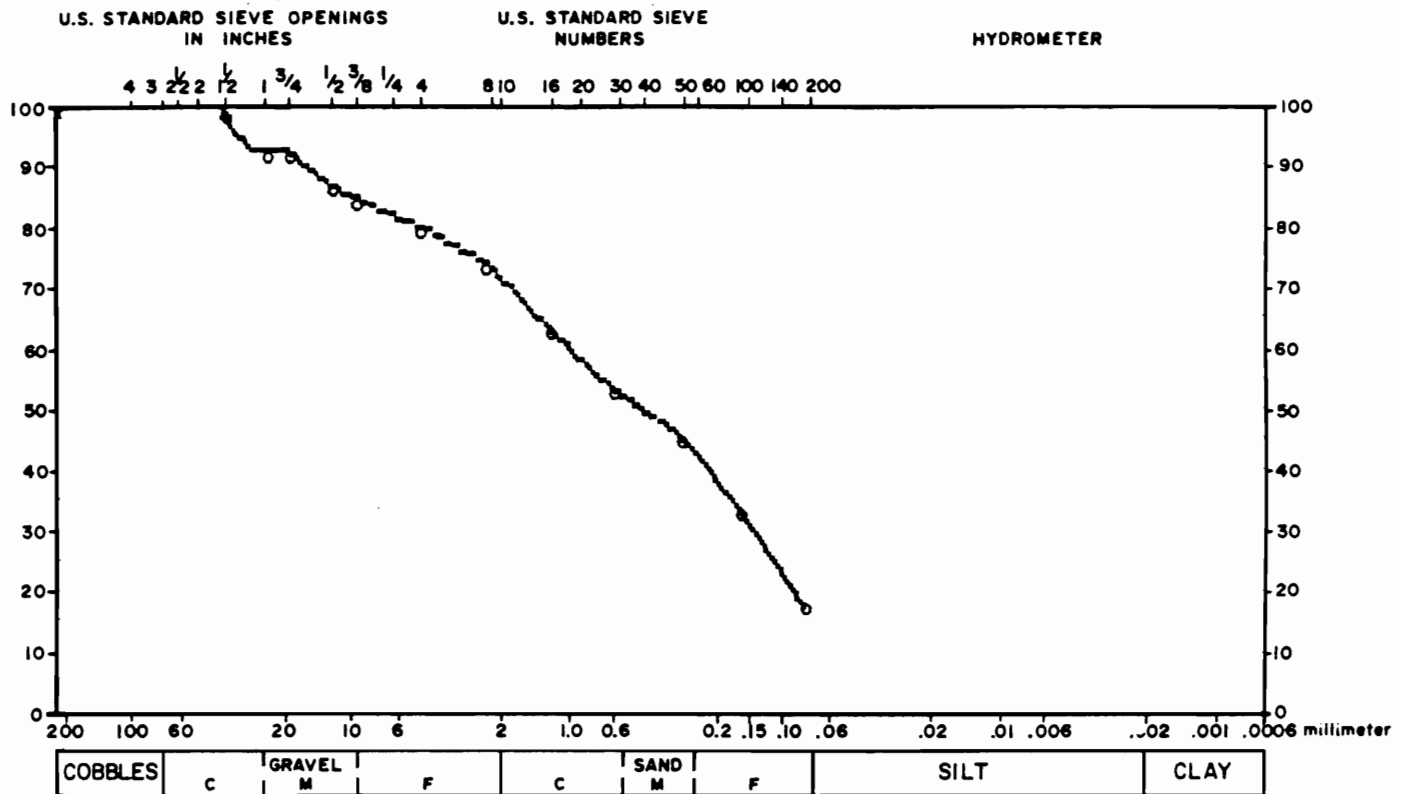

COARSE				FINE				HYDROMETER		
SIZE (Inches)	PERCENT RETAINED	CUMULATIVE PERCENT PASSING	SPECS.	SIEVE	PERCENT RETAINED	CUMULATIVE PERCENT PASSING	SPECS.	PARTICLE DIAMETER (mm)	PERCENT PASSING	SPECS.
1.5	0.00	100.00	-	4	4.77	80.58	-			
1	6.63	93.37	-	8	5.80	74.78	-			
3/4	0.00	93.37	-	16	11.08	63.70	-			
1/2	5.47	87.89	-	30	9.79	53.91	-			
3/8	2.54	85.36	-	50	7.79	46.12	-			
-	0.00	0.00	-	100	12.41	33.71	-			
-	0.00	0.00	-	200	15.83	17.88	-			
-	0.00	0.00	-	-	0.00	0.00	-			
-	0.00	0.00	-	-	0.00	0.00	-			
-	0.00	0.00	-	-	0.00	0.00	-			
-	0.00	0.00	-	-	0.00	0.00	-			
-	0.00	0.00	-	-	0.00	0.00	-			

PAN = 17.9%

WASH LOSS WAS NOT TESTED.

SPECIFICATION: ASTM C 136      ASTM D 2216

TEST STANDARD: NONE

NOTES:                      MOISTURE - 6.77%

Test samples are retained for 30 days after submission and then discarded, unless other arrangements are made.

# Dunn Geoscience Laboratory

5 Northway Lane North, Latham, NY 12110 (518) 783-8102

CLIENT: URS (VOLNEY)  
 LAB NUMBER: 86-3-96/553-3-4337 DATE RECEIVED: 3/11/86  
 TEST BY: JWH DATE TESTED: 3/12/86  
 REVIEWED BY: *MJG* DATE REPORTED: 4/7/86  
 SAMPLE DESCR: BW-4, S-5, 20' - 22'

## GRAIN SIZE DISTRIBUTION

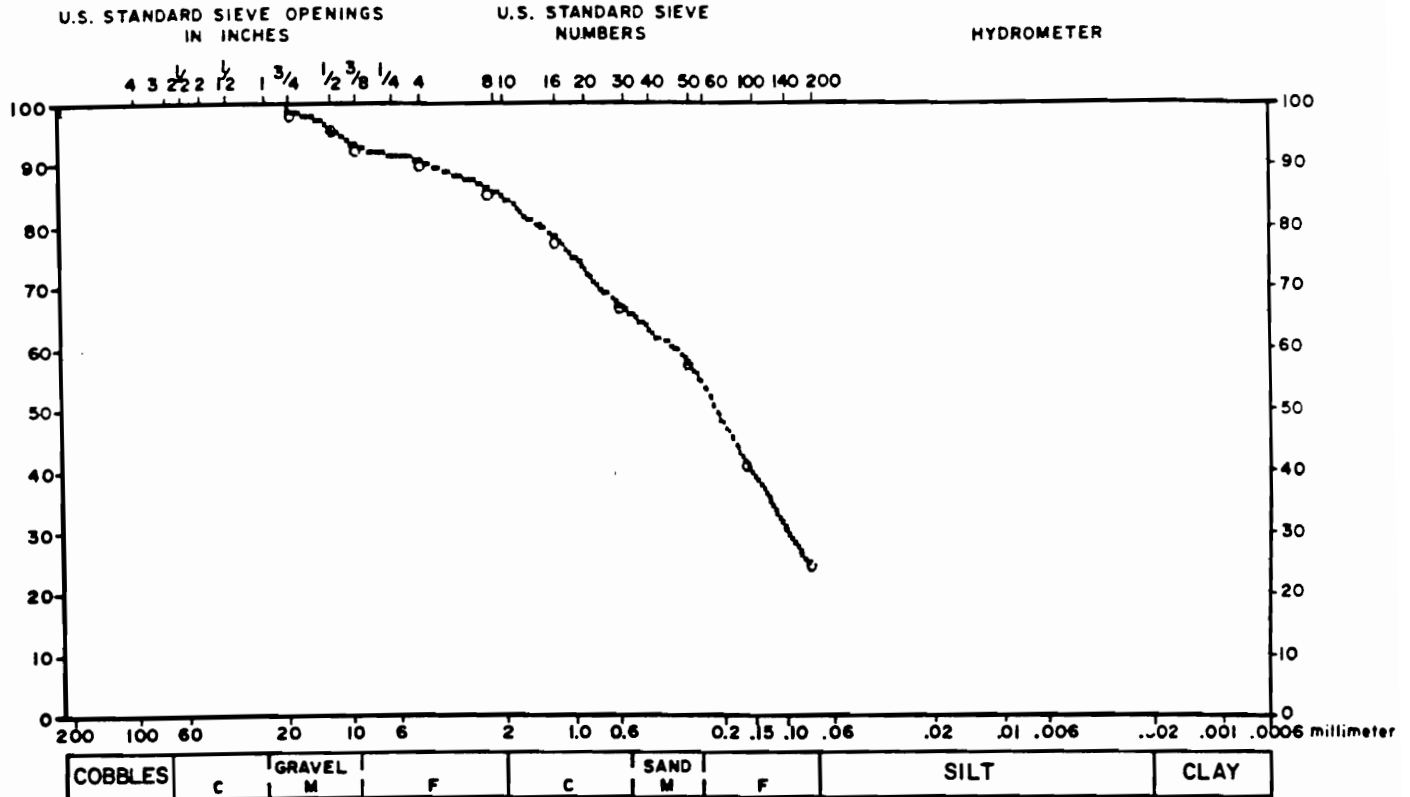

COARSE				FINE				HYDROMETER		
SIZE (Inches)	PERCENT RETAINED	CUMULATIVE PERCENT PASSING	SPECS.	SIEVE	PERCENT RETAINED	CUMULATIVE PERCENT PASSING	SPECS.	PARTICLE DIAMETER (mm)	PERCENT PASSING	SPECS.
3/4	0.00	100.00	-	4	2.90	91.12	-			
1/2	2.67	97.33	-	8	4.27	86.85	-			
3/8	3.30	94.03	-	16	7.94	78.91	-			
-	0.00	0.00	-	30	11.05	67.86	-			
-	0.00	0.00	-	50	9.51	58.34	-			
-	0.00	0.00	-	100	16.02	42.32	-			
-	0.00	0.00	-	200	17.22	25.10	-			
-	0.00	0.00	-	-	0.00	0.00	-			
-	0.00	0.00	-	-	0.00	0.00	-			
-	0.00	0.00	-	-	0.00	0.00	-			
-	0.00	0.00	-	-	0.00	0.00	-			
-	0.00	0.00	-	-	0.00	0.00	-			

PAN = 25.1%  
WASH LOSS WAS NOT TESTED.

SPECIFICATION: ASTM C 136    ASTM D 2216

TEST STANDARD: NONE

NOTES:                    MOISTURE - 7.68%

Test samples are retained for 30 days after submission and then discarded, unless other arrangements are made.



# Dunn Geoscience Laboratory

5 Northway Lane North, Latham, NY 12110 (518) 783-8102

CLIENT: URS (VOLNEY)  
 LAB NUMBER: 86-3-92/553-3-4337 DATE RECEIVED: 3/11/86  
 TEST BY: JWH DATE TESTED: 3/12/86  
 REVIEWED BY: *MJS* DATE REPORTED: 4/7/86  
 SAMPLE DESCR: BW-4, S-6, 25' - 25.5'

## GRAIN SIZE DISTRIBUTION

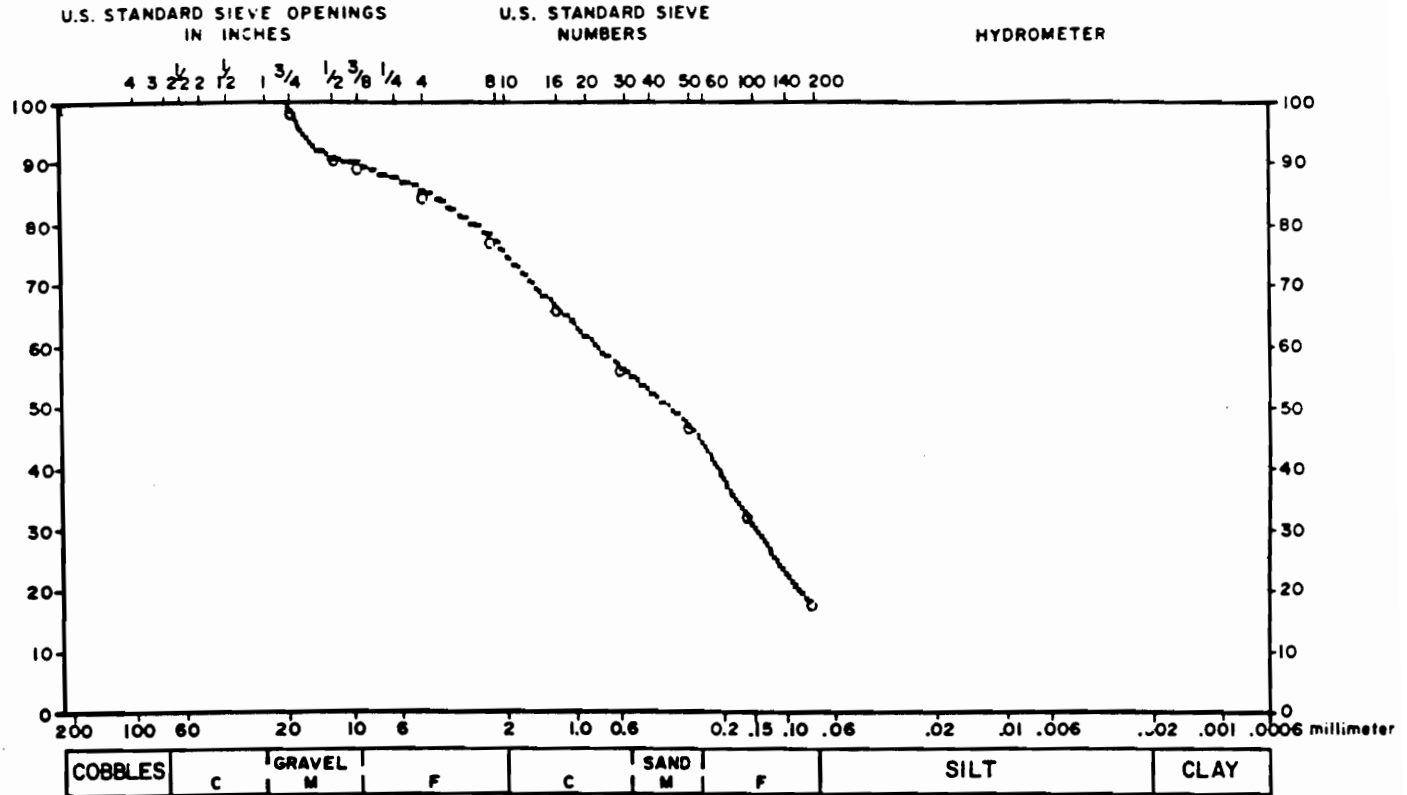

COARSE				FINE				HYDROMETER		
SIZE (Inches)	PERCENT RETAINED	CUMULATIVE PERCENT PASSING	SPECS.	SIEVE	PERCENT RETAINED	CUMULATIVE PERCENT PASSING	SPECS.	PARTICLE DIAMETER (mm)	PERCENT PASSING	SPECS.
3/4	0.00	100.00	-	4	4.37	86.09	-			
1/2	8.14	91.86	-	8	7.17	78.92	-			
3/8	1.40	90.46	-	16	11.82	67.10	-			
-	0.00	0.00	-	30	9.96	57.14	-			
-	0.00	0.00	-	50	9.21	47.93	-			
-	0.00	0.00	-	100	14.84	33.09	-			
-	0.00	0.00	-	200	14.33	18.75	-			
-	0.00	0.00	-	-	0.00	0.00	-			
-	0.00	0.00	-	-	0.00	0.00	-			
-	0.00	0.00	-	-	0.00	0.00	-			
-	0.00	0.00	-	-	0.00	0.00	-			
-	0.00	0.00	-	-	0.00	0.00	-			
-	0.00	0.00	-	-	0.00	0.00	-			

PAN = 18.8%  
 WASH LOSS WAS NOT TESTED.

SPECIFICATION: ASTM C 136    ASTM D 2216  
 TEST STANDARD: NONE  
 NOTES:                    MOISTURE - 5.82%  
 Test samples are retained for 30 days after submission and then discarded, unless other arrangements are made.

# Dunn Geoscience Laboratory

5 Northway Lane North, Latham, NY 12110 (518) 783-8102

CLIENT: URS (VOLNEY)  
 LAB NUMBER: 86-3-83/553-3-4337 DATE RECEIVED: 3/12/86  
 TEST BY: JWH DATE TESTED: 3/26/86  
 REVIEWED BY: *[Signature]* DATE REPORTED: 4/7/86  
 SAMPLE DESCR: BW-5, S-4, 15'-17'

## GRAIN SIZE DISTRIBUTION

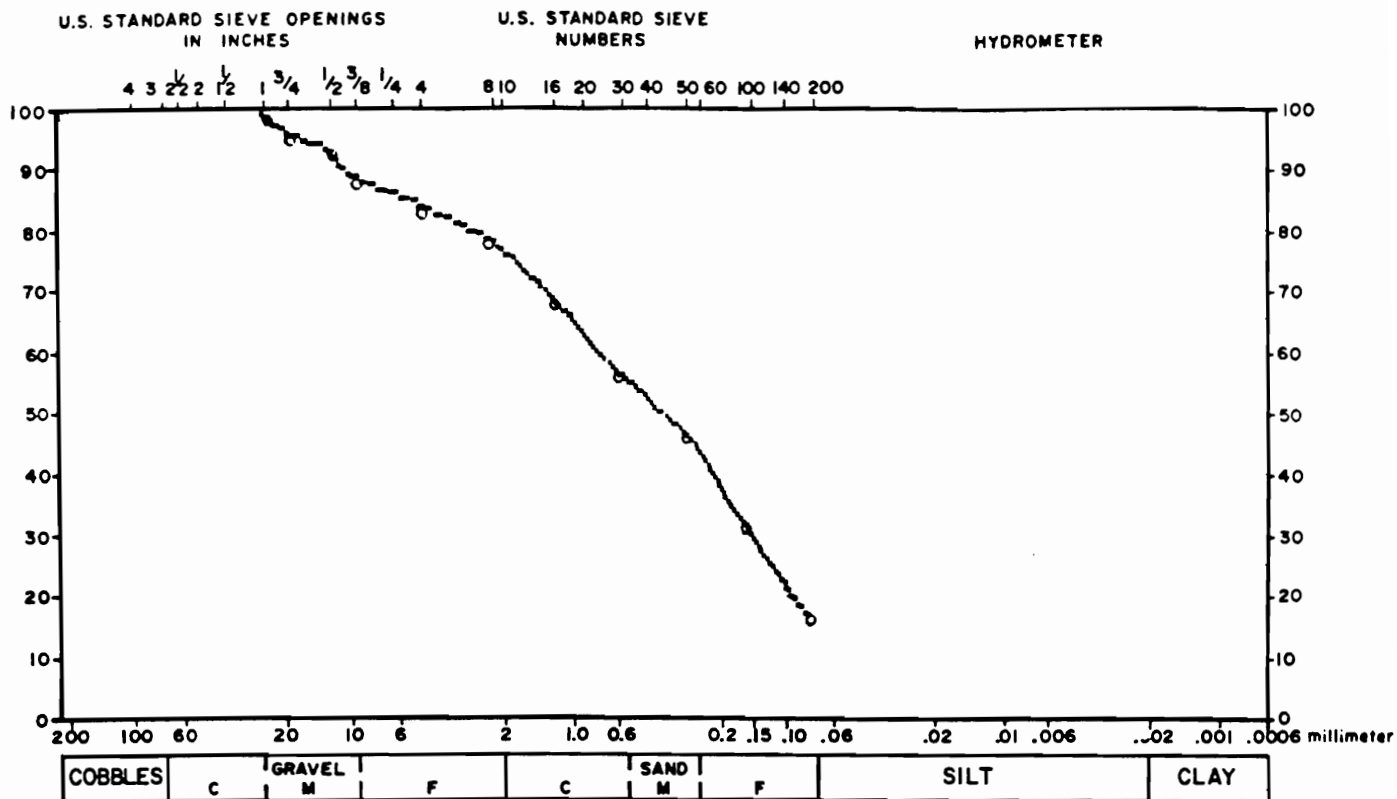

COARSE				FINE				HYDROMETER		
SIZE (Inches)	PERCENT RETAINED	CUMULATIVE PERCENT PASSING	SPECS.	SIEVE	PERCENT RETAINED	CUMULATIVE PERCENT PASSING	SPECS.	PARTICLE DIAMETER (mm)	PERCENT PASSING	SPECS.
1	0.00	100.00	-	4	4.43	84.83	-			
3/4	3.27	96.73	-	8	5.35	79.48	-			
1/2	2.92	93.81	-	16	9.92	69.56	-			
3/8	4.54	89.27	-	30	12.27	57.29	-			
-	0.00	0.00	-	50	9.71	47.58	-			
-	0.00	0.00	-	100	15.17	32.41	-			
-	0.00	0.00	-	200	15.36	17.06	-			
-	0.00	0.00	-	-	0.00	0.00	-			
-	0.00	0.00	-	-	0.00	0.00	-			
-	0.00	0.00	-	-	0.00	0.00	-			
-	0.00	0.00	-	-	0.00	0.00	-			
-	0.00	0.00	-	-	0.00	0.00	-			

PAN = 17.1%  
 WASH LOSS WAS NOT TESTED.

SPECIFICATION: ASTM C 136      ASTM D 2216

TEST STANDARD: NONE

NOTES:      MOISTURE - 6.89%

Test samples are retained for 30 days after submission and then discarded, unless other arrangements are made.

# Dunn Geoscience Laboratory

5 Northway Lane North, Letham, NY 12110 (518) 783-8102

CLIENT: URS (VOLNEY)  
 LAB NUMBER: 86-3-79/553-3-4337 DATE RECEIVED: 3/12/86  
 TEST BY: JWH DATE TESTED: 3/26/86  
 REVIEWED BY: *MJZ* DATE REPORTED: 4/7/86  
 SAMPLE DESCR: BW 7-1, S-7, 34' - 36'

## GRAIN SIZE DISTRIBUTION

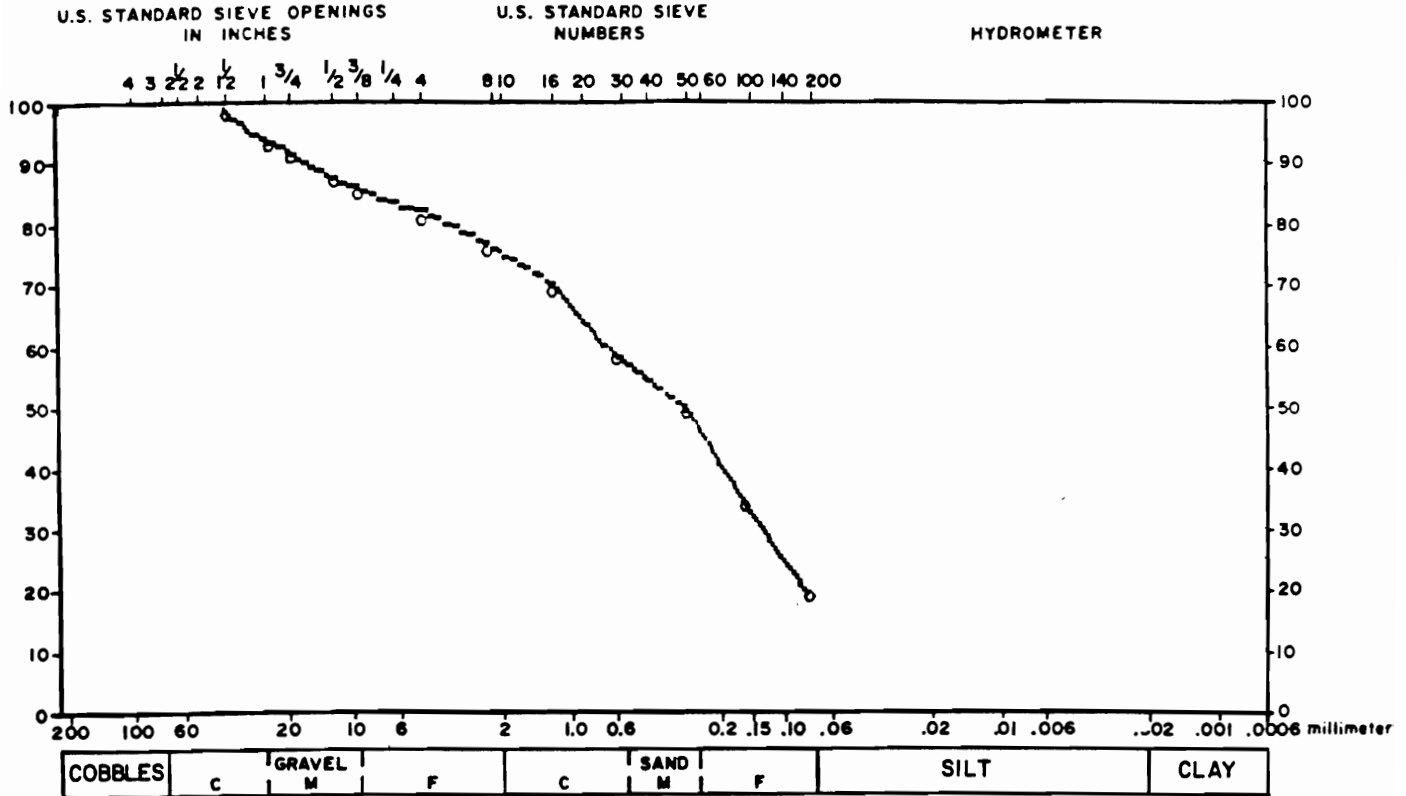

COARSE				FINE				HYDROMETER		
SIZE (Inches)	PERCENT RETAINED	CUMULATIVE PERCENT PASSING	SPECS.	SIEVE	PERCENT RETAINED	CUMULATIVE PERCENT PASSING	SPECS.	PARTICLE DIAMETER (mm)	PERCENT PASSING	SPECS.
1.5	0.00	100.00	-	4	3.61	82.87	-			
1	5.26	94.74	-	8	5.28	77.59	-			
3/4	2.00	92.74	-	16	6.65	70.94	-			
1/2	4.38	88.35	-	30	11.75	59.19	-			
3/8	1.88	86.48	-	50	8.75	50.44	-			
-	0.00	0.00	-	100	14.99	35.44	-			
-	0.00	0.00	-	200	15.64	19.80	-			
-	0.00	0.00	-	-	0.00	0.00	-			
-	0.00	0.00	-	-	0.00	0.00	-			
-	0.00	0.00	-	-	0.00	0.00	-			
-	0.00	0.00	-	-	0.00	0.00	-			
-	0.00	0.00	-	-	0.00	0.00	-			

PAN = 19.7%  
 WASH LOSS WAS NOT TESTED.

SPECIFICATION: ASTM C 136      ASTM D 2216

TEST STANDARD: NONE

NOTES:                      MOISTURE - 7.38%

Test samples are retained for 30 days after submission and then discarded, unless other arrangements are made.

# Dunn Geoscience Laboratory

5 Northway Lane North, Latham, NY 12110 (518) 783-8102

CLIENT: URS (VOLNEY)  
 LAB NUMBER: 86-3-76/553-3-4337 DATE RECEIVED: 3/12/86  
 TEST BY: JWH DATE TESTED: 3/26/86  
 REVIEWED BY: *MJZ* DATE REPORTED: 4/7/86  
 SAMPLE DESCR: BW-8D, S-18, 34' - 36'

## GRAIN SIZE DISTRIBUTION

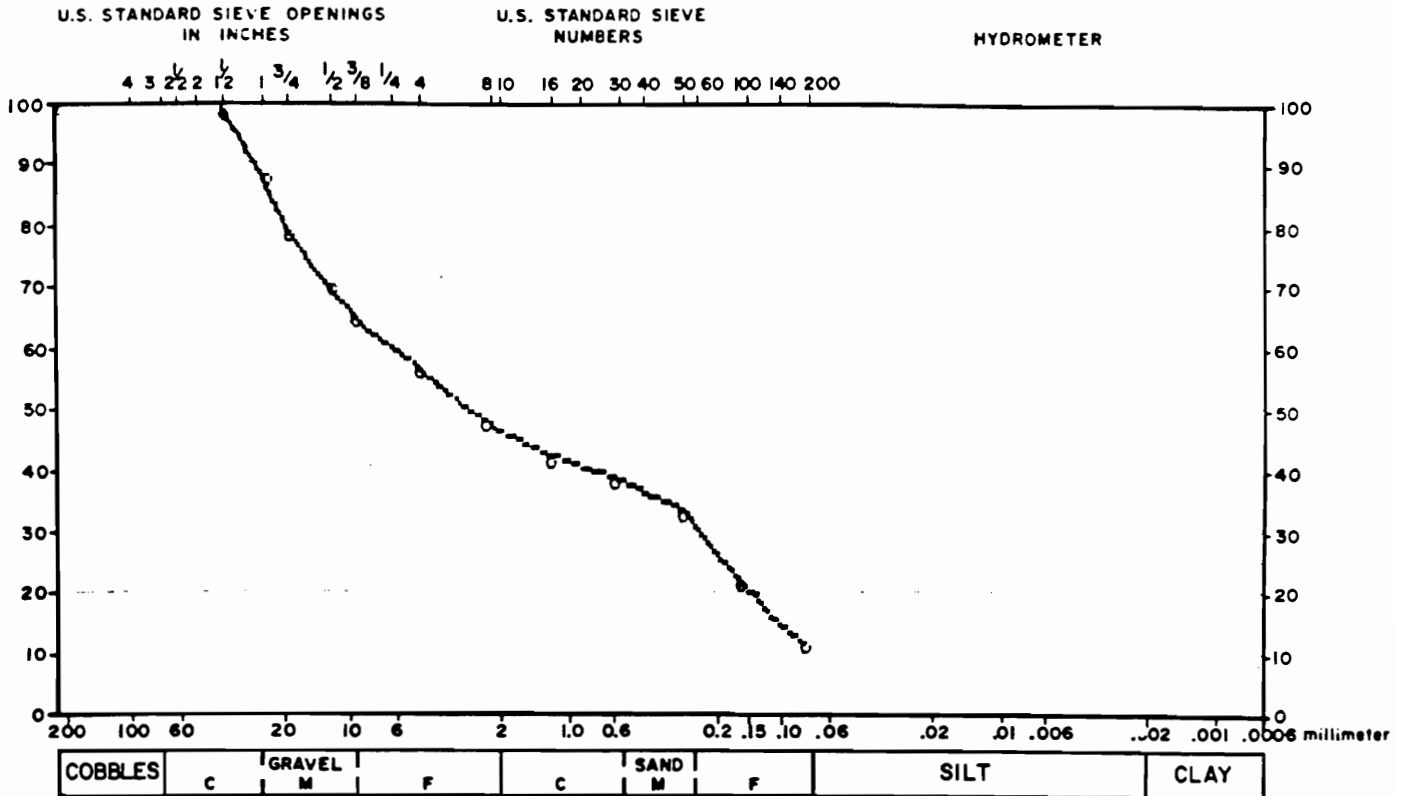

COARSE				FINE				HYDROMETER		
SIZE (Inches)	PERCENT RETAINED	CUMULATIVE PERCENT PASSING	SPECS.	SIEVE	PERCENT RETAINED	CUMULATIVE PERCENT PASSING	SPECS.	PARTICLE DIAMETER (mm)	PERCENT PASSING	SPECS.
1.5	0.00	100.00	-	4	9.00	57.22	-			
1	10.96	89.04	-	8	8.65	48.57	-			
3/4	8.71	80.33	-	16	5.58	43.00	-			
1/2	9.21	71.12	-	30	3.98	39.02	-			
3/8	4.89	66.23	-	50	4.91	34.11	-			
-	0.00	0.00	-	100	11.18	22.93	-			
-	0.00	0.00	-	200	11.12	11.81	-			
-	0.00	0.00	-	-	0.00	0.00	-			
-	0.00	0.00	-	-	0.00	0.00	-			
-	0.00	0.00	-	-	0.00	0.00	-			
-	0.00	0.00	-	-	0.00	0.00	-			
-	0.00	0.00	-	-	0.00	0.00	-			

PAN = 11.8%  
 WASH LOSS WAS NOT TESTED.

SPECIFICATION: ASTM C 136      ASTM D 2216

TEST STANDARD: NONE

NOTES:      MOISTURE - 8.27%

Test samples are retained for 30 days after submission and then discarded, unless other arrangements are made.

# Dunn Geoscience Laboratory

5 Northway Lane North, Latham, NY 12110 (518) 783-8102

CLIENT: URS (VOLNEY)  
 LAB NUMBER: 86-3-102/553-3-4337 DATE RECEIVED: 3/11/86  
 TEST BY: JWH DATE TESTED: 3/12/86  
 REVIEWED BY: *MJZ* DATE REPORTED: 4/7/86  
 SAMPLE DESCR: BW-9, S-6, 25' - 27'

## GRAIN SIZE DISTRIBUTION

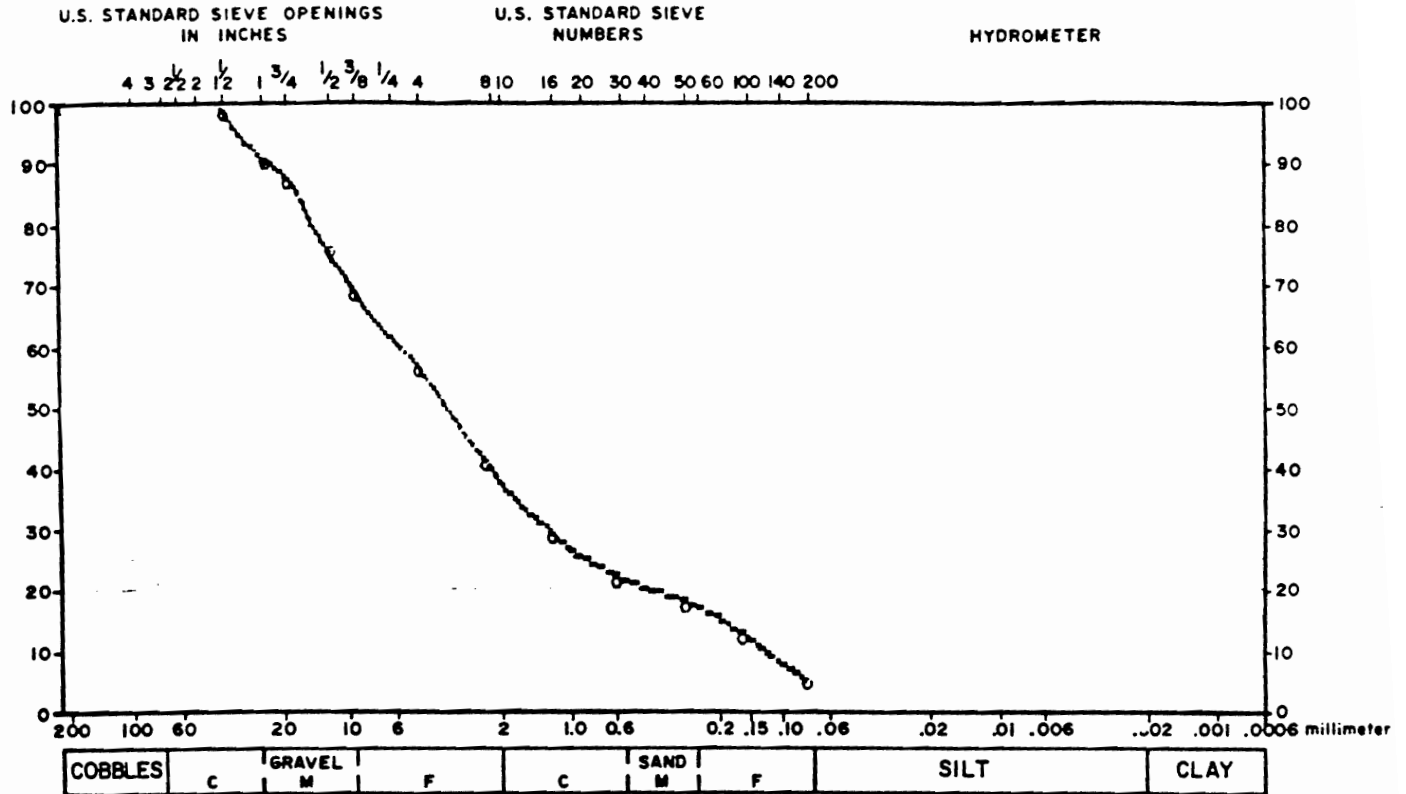

COARSE				FINE				HYDROMETER		
SIZE (Inches)	PERCENT RETAINED	CUMULATIVE PERCENT PASSING	SPECS.	SIEVE	PERCENT RETAINED	CUMULATIVE PERCENT PASSING	SPECS.	PARTICLE DIAMETER (mm)	PERCENT PASSING	SPECS.
1.5	0.00	100.00	-	4	13.10	57.03	-			
1	8.02	91.98	-	8	15.31	41.73	-			
3/4	3.05	88.94	-	16	12.00	29.72	-			
1/2	11.72	77.22	-	30	7.10	22.62	-			
3/8	7.08	70.14	-	50	3.80	18.82	-			
-	0.00	0.00	-	100	5.41	13.41	-			
-	0.00	0.00	-	200	8.13	5.27	-			
-	0.00	0.00	-	-	0.00	0.00	-			
-	0.00	0.00	-	-	0.00	0.00	-			
-	0.00	0.00	-	-	0.00	0.00	-			
-	0.00	0.00	-	-	0.00	0.00	-			
-	0.00	0.00	-	-	0.00	0.00	-			

PAN = 5.3%  
 WASH LOSS WAS NOT TESTED.

SPECIFICATION: ASTM C 136      ASTM D 2216

TEST STANDARD: NONE

NOTES:      MOISTURE - 3.33%

Test samples are retained for 30 days after submission and then discarded, unless other arrangements are made.

# Dunn Geoscience Laboratory

5 Northway Lane North, Latham, NY 12110 (518) 783-8102

CLIENT: URS (VOLNEY)  
 LAB NUMBER: 86-3-88/553-3-4337 DATE RECEIVED: 3/11/86  
 TEST BY: JWH DATE TESTED: 3/12/86  
 REVIEWED BY: *Mgg* DATE REPORTED: 4/7/86  
 SAMPLE DESCR: BW-10, S-1, GRAB SAMPLE

## GRAIN SIZE DISTRIBUTION

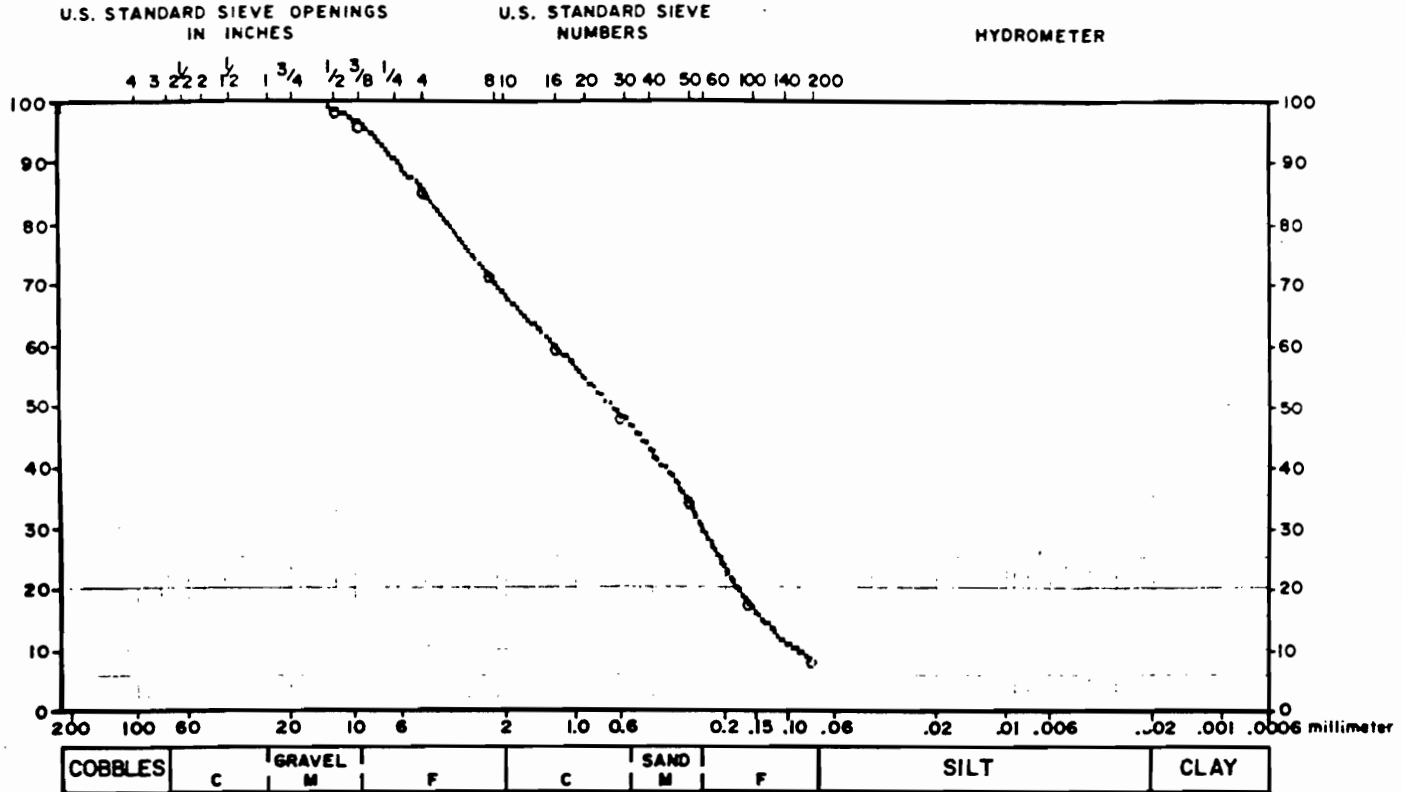

COARSE				FINE				HYDROMETER		
SIZE (Inches)	PERCENT RETAINED	CUMULATIVE PERCENT PASSING	SPECS.	SIEVE	PERCENT RETAINED	CUMULATIVE PERCENT PASSING	SPECS.	PARTICLE DIAMETER (mm)	PERCENT PASSING	SPECS.
1/2	0.00	100.00	-	4	11.07	86.49	-			
3/8	2.44	97.56	-	8	14.05	72.45	-			
-	0.00	0.00	-	16	11.64	60.81	-			
-	0.00	0.00	-	30	11.37	49.43	-			
-	0.00	0.00	-	50	13.81	35.62	-			
-	0.00	0.00	-	100	16.83	18.79	-			
-	0.00	0.00	-	200	10.13	8.66	-			
-	0.00	0.00	-	-	0.00	0.00	-			
-	0.00	0.00	-	-	0.00	0.00	-			
-	0.00	0.00	-	-	0.00	0.00	-			
-	0.00	0.00	-	-	0.00	0.00	-			
-	0.00	0.00	-	-	0.00	0.00	-			

PAN = 8.7%

WASH LOSS WAS NOT TESTED.

SPECIFICATION: ASTM C 136      ASTM D 2216

TEST STANDARD: NONE

NOTES: MOISTURE - .22%

Test samples are retained for 30 days after submission and then discarded, unless other arrangements are made.

# Dunn Geoscience Laboratory

5 Northway Lane North, Latham, NY 12110 (518) 783-8102

CLIENT: URS (VOLNEY)  
 LAB NUMBER: 86-3-100/553-3-4337 DATE RECEIVED: 3/11/86  
 TEST BY: JWH DATE TESTED: 3/12/86  
 REVIEWED BY: *[Signature]* DATE REPORTED: 4/7/86  
 SAMPLE DESCR: BW-13, S-3, 10' - 11'

## GRAIN SIZE DISTRIBUTION

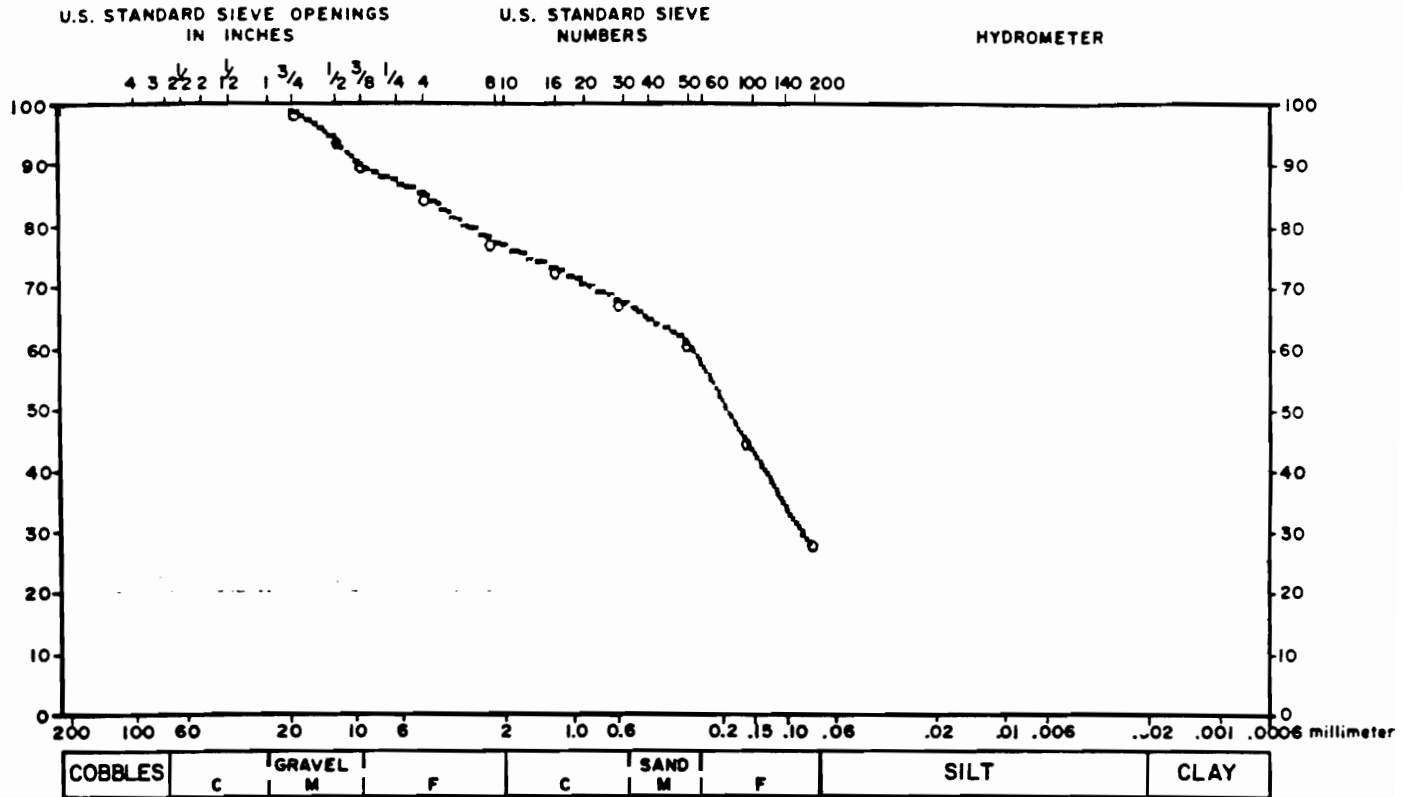

COARSE				FINE				HYDROMETER		
SIZE (Inches)	PERCENT RETAINED	CUMULATIVE PERCENT PASSING	SPECS.	SIEVE	PERCENT RETAINED	CUMULATIVE PERCENT PASSING	SPECS.	PARTICLE DIAMETER (mm)	PERCENT PASSING	SPECS.
3/4	0.00	100.00	-	4	5.31	85.89	-			
1/2	4.35	95.65	-	8	7.22	78.67	-			
3/8	4.45	91.20	-	16	4.83	73.84	-			
-	0.00	0.00	-	30	5.12	68.72	-			
-	0.00	0.00	-	50	7.03	61.69	-			
-	0.00	0.00	-	100	15.83	45.86	-			
-	0.00	0.00	-	200	17.31	28.55	-			
-	0.00	0.00	-	-	0.00	0.00	-			
-	0.00	0.00	-	-	0.00	0.00	-			
-	0.00	0.00	-	-	0.00	0.00	-			
-	0.00	0.00	-	-	0.00	0.00	-			
-	0.00	0.00	-	-	0.00	0.00	-			

PAN = 28.6%  
 WASH LOSS WAS NOT TESTED.

SPECIFICATION: ASTM C 136      ASTM D 2216  
 TEST STANDARD: NONE  
 NOTES:      MOISTURE - 6.65%  
 Test samples are retained for 30 days after submission and then discarded, unless other arrangements are made.

# Dunn Geoscience Laboratory

5 Northway Lane North, Latham, NY 12110 (518) 783-8102

CLIENT: URS (VOLNEY)  
 LAB NUMBER: 86-3-98/553-3-4337 DATE RECEIVED: 3/11/86  
 TEST BY: JWH DATE TESTED: 3/12/86  
 REVIEWED BY: *MJS* DATE REPORTED: 4/7/86  
 SAMPLE DESCR: BW-14, S-3, 14' - 16'

## GRAIN SIZE DISTRIBUTION

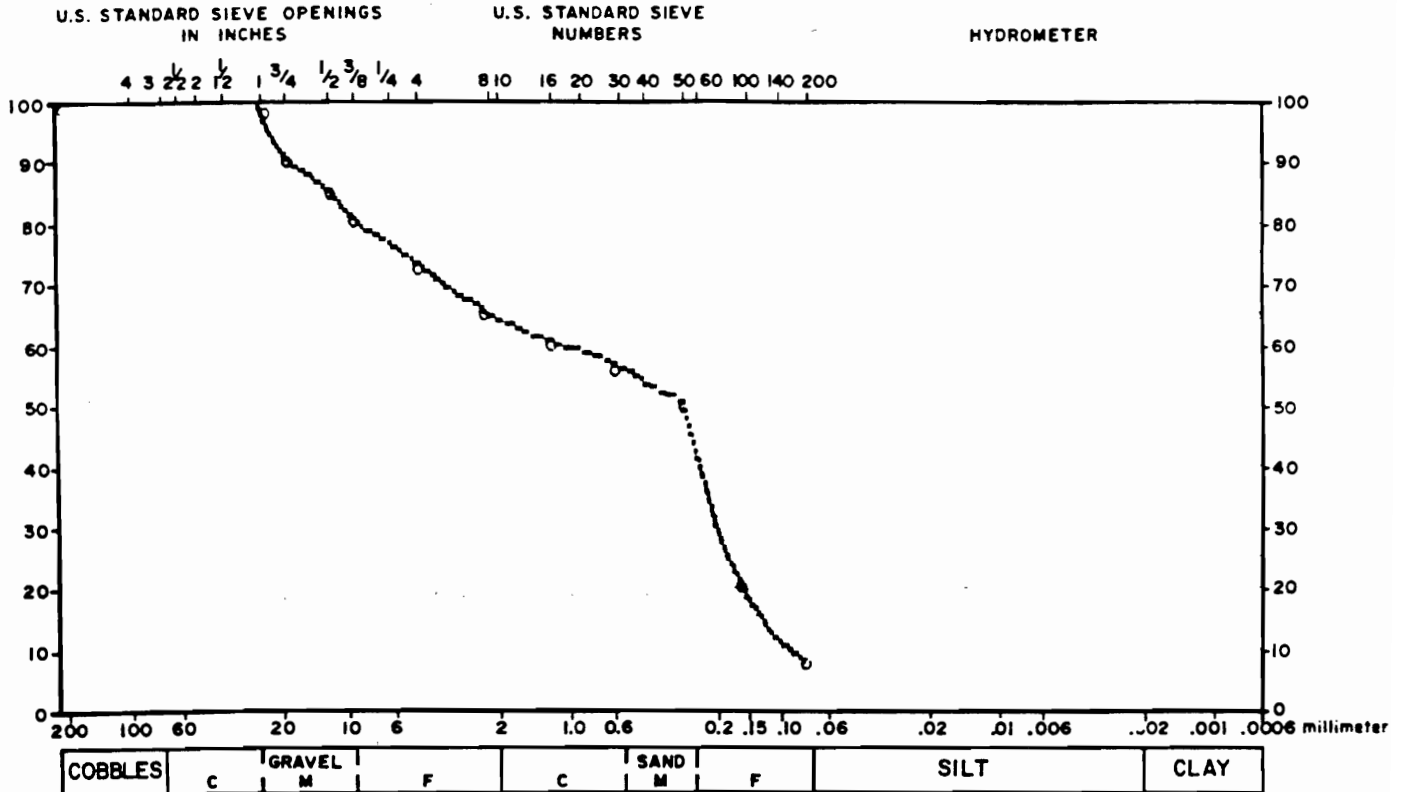

COARSE				FINE				HYDROMETER		
SIZE (Inches)	PERCENT RETAINED	CUMULATIVE PERCENT PASSING	SPECS.	SIEVE	PERCENT RETAINED	CUMULATIVE PERCENT PASSING	SPECS.	PARTICLE DIAMETER (mm)	PERCENT PASSING	SPECS.
1	0.00	100.00	-	4	7.83	74.21	-			
3/4	8.20	91.80	-	8	7.87	66.34	-			
1/2	5.23	86.57	-	16	4.98	61.36	-			
3/8	4.52	82.04	-	30	3.79	57.58	-			
-	0.00	0.00	-	50	6.57	51.01	-			
-	0.00	0.00	-	100	29.25	21.76	-			
-	0.00	0.00	-	200	13.19	8.57	-			
-	0.00	0.00	-	-	0.00	0.00	-			
-	0.00	0.00	-	-	0.00	0.00	-			
-	0.00	0.00	-	-	0.00	0.00	-			
-	0.00	0.00	-	-	0.00	0.00	-			
-	0.00	0.00	-	-	0.00	0.00	-			

PAN = 8.7%  
 WASH LOSS WAS NOT TESTED.

SPECIFICATION: ASTM C 136    ASTM D 2216  
 TEST STANDARD: NONE  
 NOTES:                    MOISTURE - 12.37%  
 Test samples are retained for 30 days after submission and then discarded, unless other arrangements are made.



# Dunn Geoscience Laboratory

5 Northway Lane North, Latham, NY 12110 (518) 783-8102

CLIENT: URS (VOLNEY)  
 LAB NUMBER: 86-3-101/553-3-4337 DATE RECEIVED: 3/11/86  
 TEST BY: JWH DATE TESTED: 3/12/86  
 REVIEWED BY: *MJZ* DATE REPORTED: 4/7/86  
 SAMPLE DESCR: BW-17, S-2, 9' - 11'

## GRAIN SIZE DISTRIBUTION

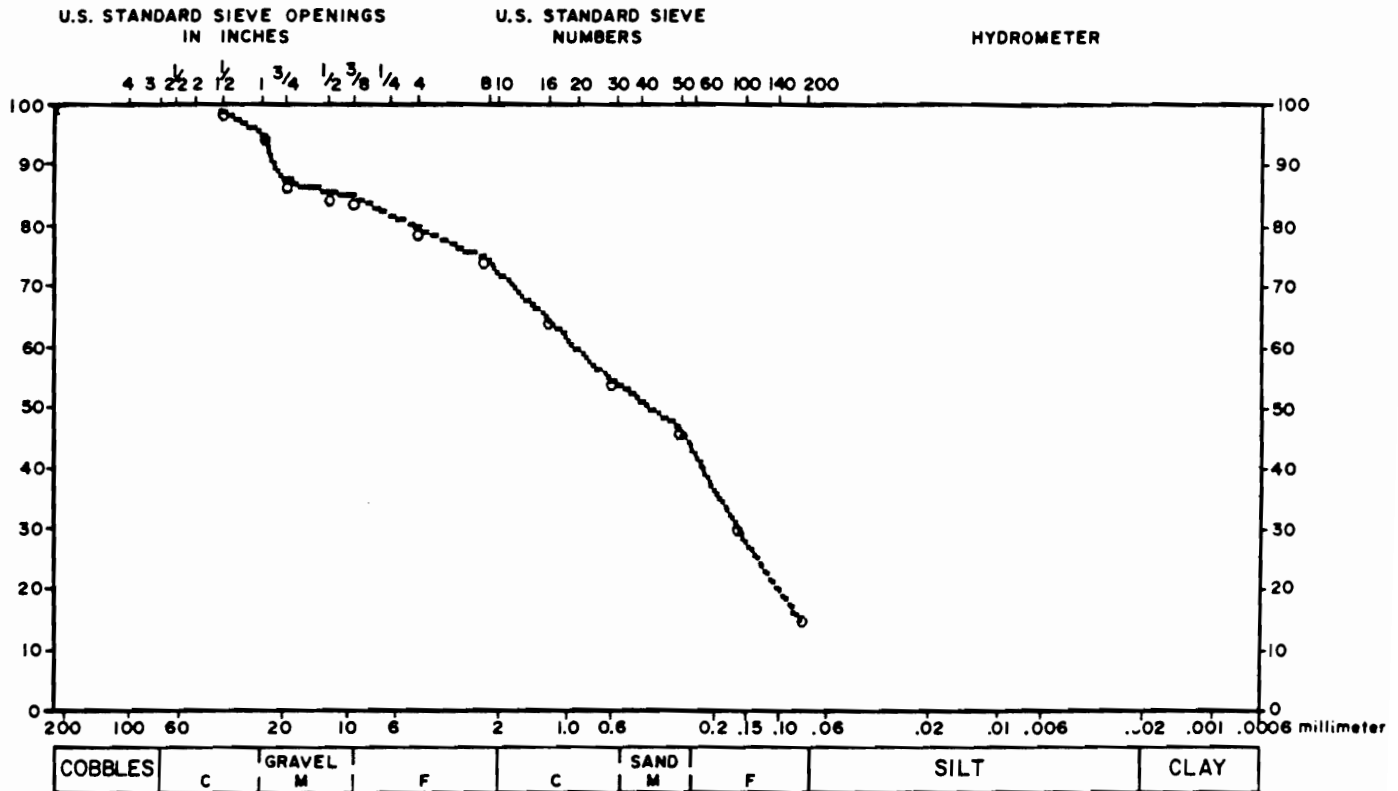

COARSE				FINE				HYDROMETER		
SIZE (Inches)	PERCENT RETAINED	CUMULATIVE PERCENT PASSING	SPECS.	SIEVE	PERCENT RETAINED	CUMULATIVE PERCENT PASSING	SPECS.	PARTICLE DIAMETER (mm)	PERCENT PASSING	SPECS.
1.5	0.00	100.00	-	4	5.20	80.14	-			
1	4.01	95.99	-	8	4.93	75.21	-			
3/4	7.90	88.09	-	16	10.08	65.14	-			
1/2	2.02	86.07	-	30	9.87	55.27	-			
3/8	.74	85.34	-	50	8.04	47.23	-			
-	0.00	0.00	-	100	16.18	31.04	-			
-	0.00	0.00	-	200	15.67	15.37	-			
-	0.00	0.00	-	-	0.00	0.00	-			
-	0.00	0.00	-	-	0.00	0.00	-			
-	0.00	0.00	-	-	0.00	0.00	-			
-	0.00	0.00	-	-	0.00	0.00	-			
-	0.00	0.00	-	-	0.00	0.00	-			
-	0.00	0.00	-	-	0.00	0.00	-			

PAN = 15.4%  
 WASH LOSS WAS NOT TESTED.

SPECIFICATION: ASTM C 136    ASTM D 2216

TEST STANDARD: NONE

NOTES:                    MOISTURE 8.20%

Test samples are retained for 30 days after submission and then discarded, unless other arrangements are made.

# Dunn Geoscience Laboratory

5 Northway Lane North, Latham, NY 12110 (518) 783-8102

CLIENT: URS (VOLNEY)  
 LAB NUMBER: 86-3-105/553-3-4337 DATE RECEIVED: 3/11/86  
 TEST BY: JWH DATE TESTED: 3/12/86  
 REVIEWED BY: *MJS* DATE REPORTED: 4/7/86  
 SAMPLE DESCR: B-17, S-3, 14' - 16'

## GRAIN SIZE DISTRIBUTION

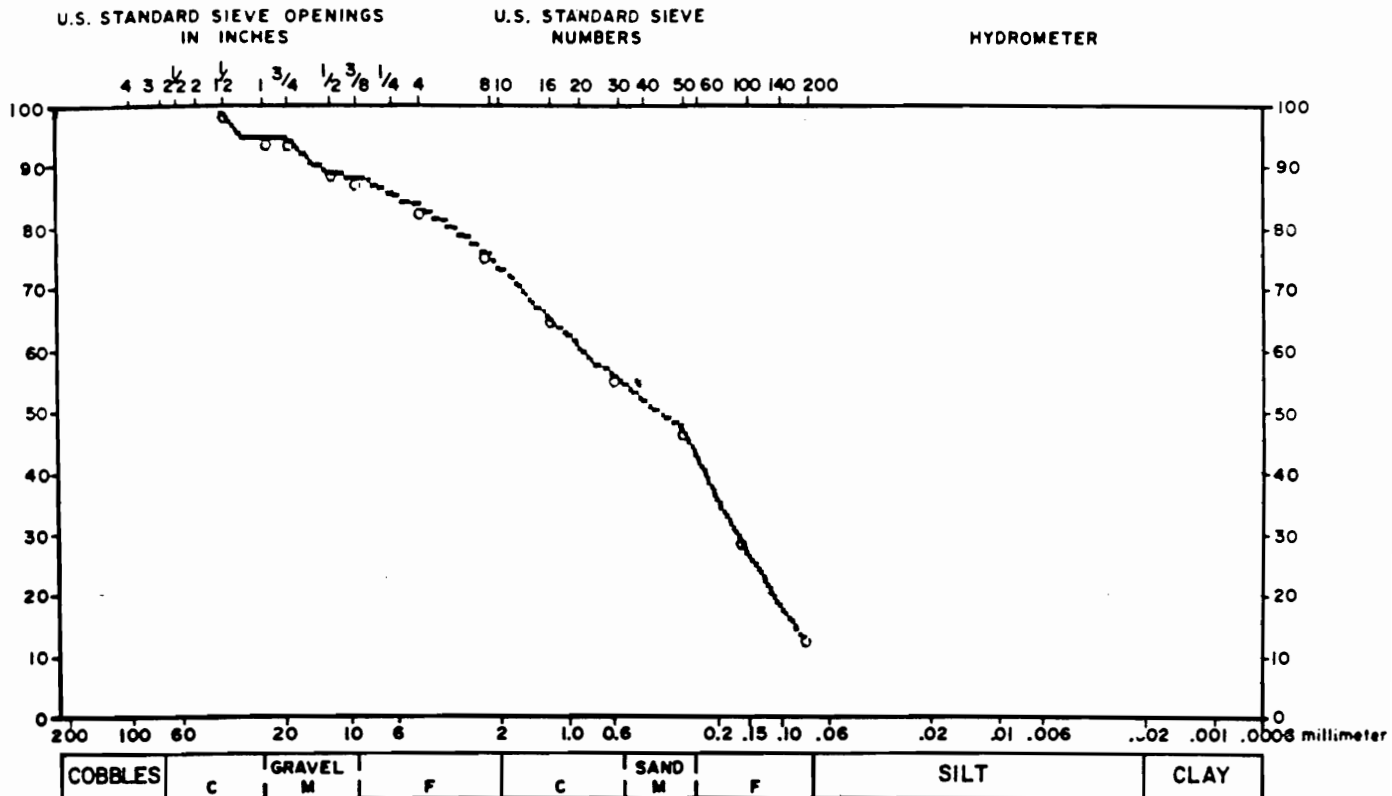

COARSE				FINE				HYDROMETER		
SIZE (Inches)	PERCENT RETAINED	CUMULATIVE PERCENT PASSING	SPECS.	SIEVE	PERCENT RETAINED	CUMULATIVE PERCENT PASSING	SPECS.	PARTICLE DIAMETER (mm)	PERCENT PASSING	SPECS.
1.5	0.00	100.00	-	4	4.93	83.88	-			
1	4.97	95.03	-	8	7.00	76.88	-			
3/4	0.00	95.03	-	16	11.04	65.84	-			
1/2	5.25	89.79	-	30	9.47	56.37	-			
3/8	.98	88.81	-	50	8.64	47.73	-			
-	0.00	0.00	-	100	18.03	29.71	-			
-	0.00	0.00	-	200	16.30	13.41	-			
-	0.00	0.00	-	-	0.00	0.00	-			
-	0.00	0.00	-	-	0.00	0.00	-			
-	0.00	0.00	-	-	0.00	0.00	-			
-	0.00	0.00	-	-	0.00	0.00	-			
-	0.00	0.00	-	-	0.00	0.00	-			

PAN = 13.4%  
 WASH LOSS WAS NOT TESTED.

SPECIFICATION: ASTM C 136      ASTM D 2216

TEST STANDARD: NONE

NOTES:                      MOISTURE - 9.26%

Test samples are retained for 30 days after submission and then discarded, unless other arrangements are made.

# Dunn Geoscience Laboratory

5 Northway Lane North, Latham, NY 12110 (518) 783-8102

CLIENT: URS (VOLNEY)  
 LAB NUMBER: 86-3-97/553-3-4337 DATE RECEIVED: 3/11/86  
 TEST BY: JWH DATE TESTED: 3/12/86  
 REVIEWED BY: *[Signature]* DATE REPORTED: 4/7/86  
 SAMPLE DESCR: BW-3, S-4, 6' - 8'

## GRAIN SIZE DISTRIBUTION

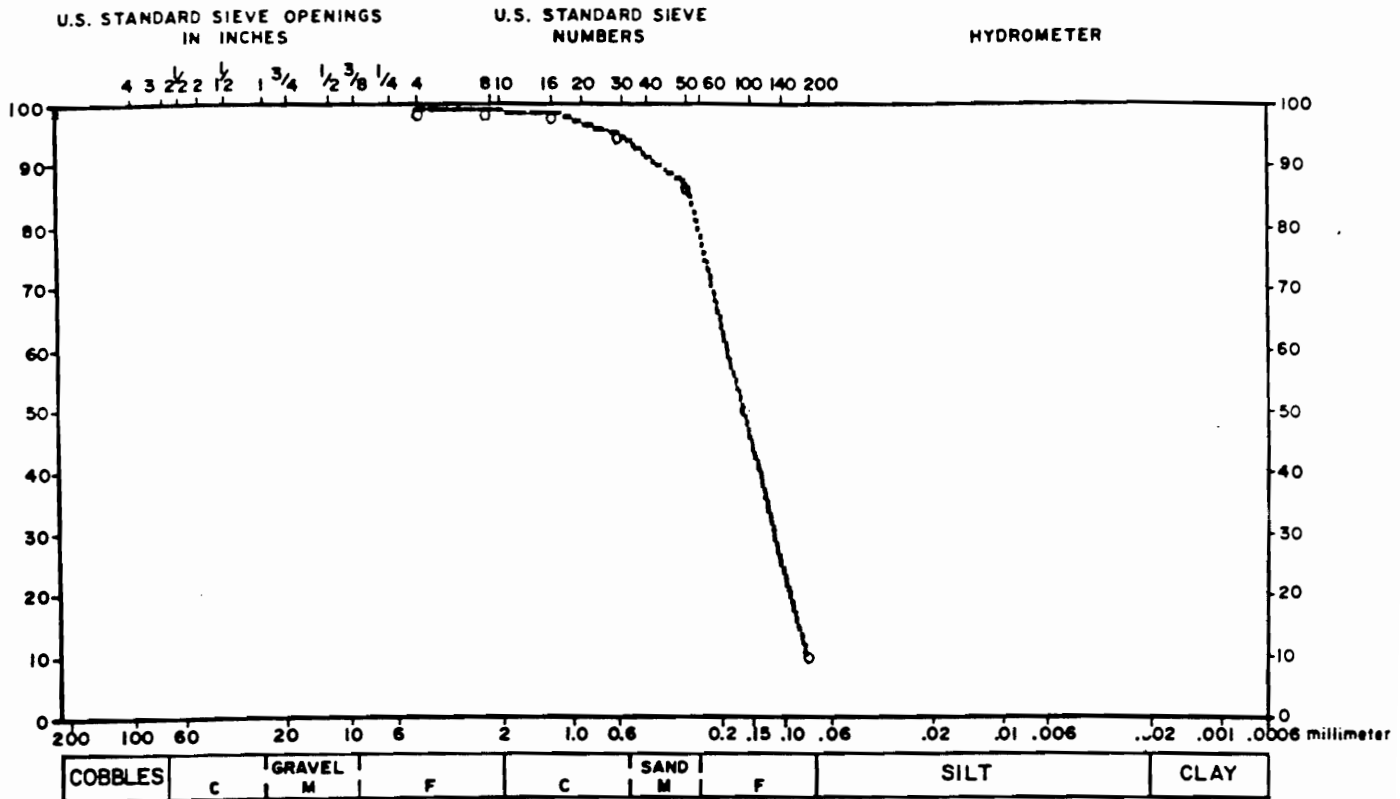

COARSE				FINE				HYDROMETER		
SIZE (Inches)	PERCENT RETAINED	CUMULATIVE PERCENT PASSING	SPECS.	SIEVE	PERCENT RETAINED	CUMULATIVE PERCENT PASSING	SPECS.	PARTICLE DIAMETER (mm)	PERCENT PASSING	SPECS.
-	0.00	0.00	-	4	0.00	100.00	-			
-	0.00	0.00	-	8	.08	99.92	-			
-	0.00	0.00	-	16	.63	99.29	-			
-	0.00	0.00	-	30	3.35	95.93	-			
-	0.00	0.00	-	50	7.88	88.06	-			
-	0.00	0.00	-	100	36.88	51.17	-			
-	0.00	0.00	-	200	40.61	10.56	-			
-	0.00	0.00	-	-	0.00	0.00	-			
-	0.00	0.00	-	-	0.00	0.00	-			
-	0.00	0.00	-	-	0.00	0.00	-			
-	0.00	0.00	-	-	0.00	0.00	-			

PAN = 10.6%  
 WASH LOSS WAS NOT TESTED.

SPECIFICATION: ASTM C 136 , ASTM D 2216  
 TEST STANDARD: NONE

NOTES: MOISTURE - 21.88%  
 Test samples are retained for 30 days after submission and then discarded, unless other arrangements are made.

# Dunn Geoscience Laboratory

5 Northway Lane North, Latham, NY 12110 (518) 783-8102

CLIENT: URS (VOLNEY)  
 LAB NUMBER: 86-3-94/553-3-4337 DATE RECEIVED: 3/11/86  
 TEST BY: JWH DATE TESTED: 3/12/86  
 REVIEWED BY: *MJB* DATE REPORTED: 4/7/86  
 SAMPLE DESCR: BW-3, S-6, 10' - 12'

## GRAIN SIZE DISTRIBUTION

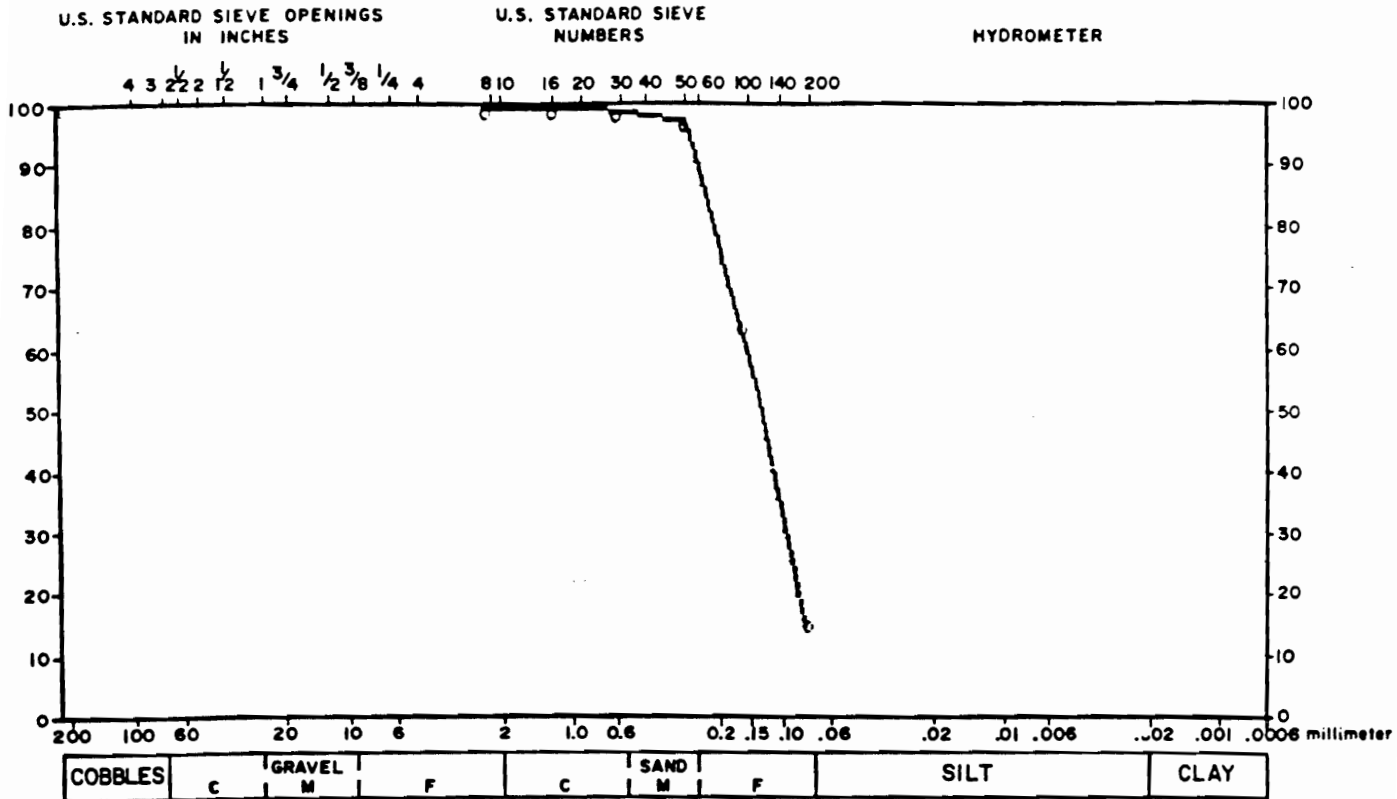

COARSE				FINE				HYDROMETER		
SIZE (Inches)	PERCENT RETAINED	CUMULATIVE PERCENT PASSING	SPECS.	SIEVE	PERCENT RETAINED	CUMULATIVE PERCENT PASSING	SPECS.	PARTICLE DIAMETER (mm)	PERCENT PASSING	SPECS.

-	0.00	0.00	-	8	0.00	100.00	-			
-	0.00	0.00	-	16	.08	99.92	-			
-	0.00	0.00	-	30	.29	99.62	-			
-	0.00	0.00	-	50	1.58	98.04	-			
-	0.00	0.00	-	100	33.10	64.94	-			
-	0.00	0.00	-	200	49.77	15.17	-			
-	0.00	0.00	-	-	0.00	0.00	-			
-	0.00	0.00	-	-	0.00	0.00	-			
-	0.00	0.00	-	-	0.00	0.00	-			
-	0.00	0.00	-	-	0.00	0.00	-			
-	0.00	0.00	-	-	0.00	0.00	-			
-	0.00	0.00	-	-	0.00	0.00	-			

PAN = 15.2%

WASH LOSS WAS NOT TESTED.

SPECIFICATION: ASTM C 136      ASTM D 2216

TEST STANDARD: NONE

NOTES:                      MOISTURE - 24.51%

Test samples are retained for 30 days after submission

and then discarded, unless other arrangements are made.

# Dunn Geoscience Laboratory

5 Northway Lane North, Latham, NY 12110 (518) 783-8102

CLIENT: URS (VOLNEY)  
 LAB NUMBER: 86-3-86/553-3-4337 DATE RECEIVED: 3/11/86  
 TEST BY: JWH DATE TESTED: 3/12/86  
 REVIEWED BY: *[Signature]* DATE REPORTED: 4/7/86  
 SAMPLE DESCR: BW-3, S-14, 26' - 28'

## GRAIN SIZE DISTRIBUTION

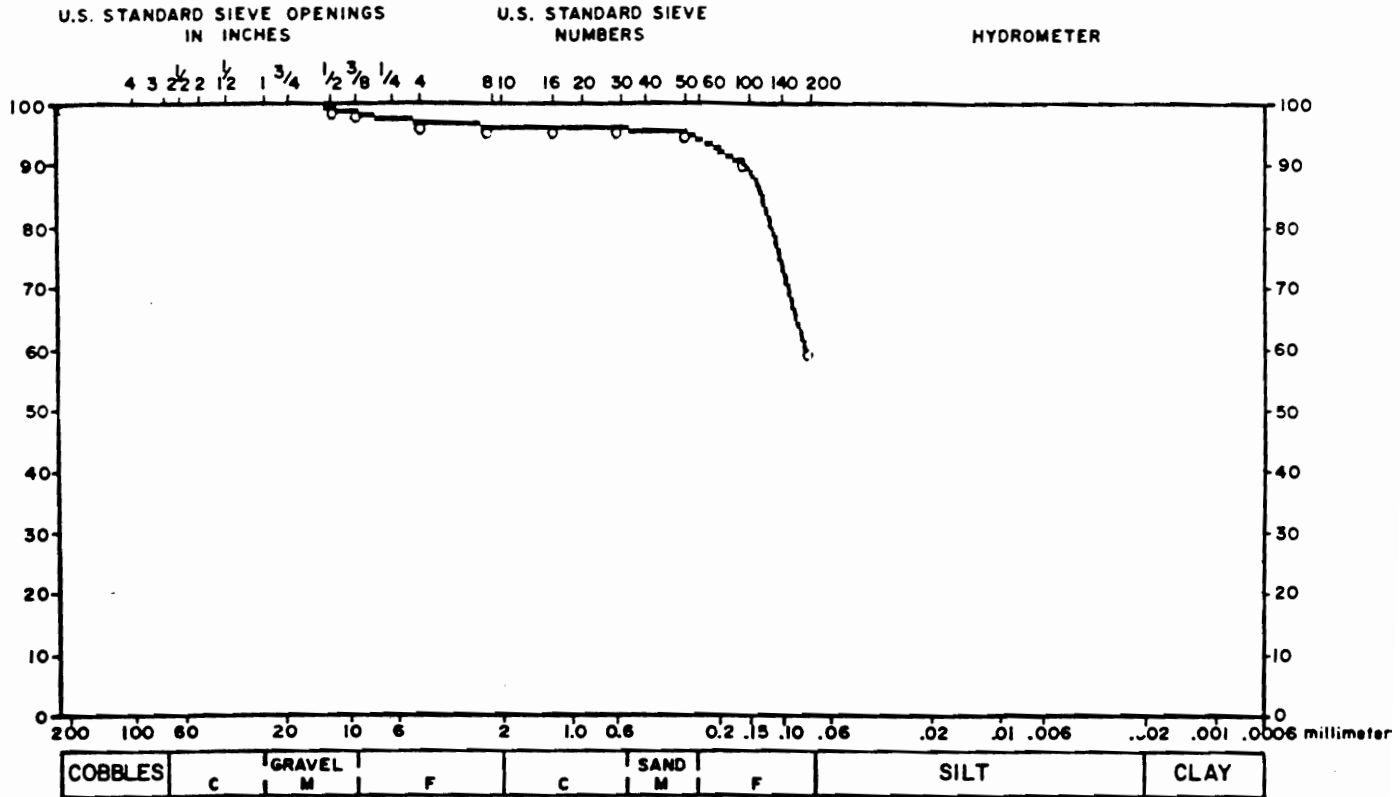

COARSE				FINE				HYDROMETER		
SIZE (Inches)	PERCENT RETAINED	CUMULATIVE PERCENT PASSING	SPECS.	SIEVE	PERCENT RETAINED	CUMULATIVE PERCENT PASSING	SPECS.	PARTICLE DIAMETER (mm)	PERCENT PASSING	SPECS.
1/2	0.00	100.00	-	4	1.68	97.49	-			
3/8	.84	99.16	-	8	.50	96.98	-			
-	0.00	0.00	-	16	.29	96.69	-			
-	0.00	0.00	-	30	.29	96.40	-			
-	0.00	0.00	-	50	.46	95.94	-			
-	0.00	0.00	-	100	4.44	91.50	-			
-	0.00	0.00	-	200	31.83	59.67	-			
-	0.00	0.00	-	-	0.00	0.00	-			
-	0.00	0.00	-	-	0.00	0.00	-			
-	0.00	0.00	-	-	0.00	0.00	-			
-	0.00	0.00	-	-	0.00	0.00	-			
-	0.00	0.00	-	-	0.00	0.00	-			

PAN = 59.7%  
 WASH LOSS WAS NOT TESTED.

SPECIFICATION: ASTM C 136      ASTM D 2216

TEST STANDARD: NONE

NOTES: MOISTURE - 20.98%

# Dunn Geoscience Laboratory

5 Northway Lane North, Latham, NY 12110 (518) 783-8102

CLIENT: URS VOLNEY  
 LAB NUMBER: 86-3-108/553-3-4337  
 TEST BY: JWH  
 REVIEWED BY: *mgz*  
 SAMPLE DESCR: BW-7I, S-5, 24'-26'

DATE RECEIVED: 3/12/86  
 DATE TESTED: 3/26/86  
 DATE REPORTED: 4/23/86

## GRAIN SIZE DISTRIBUTION

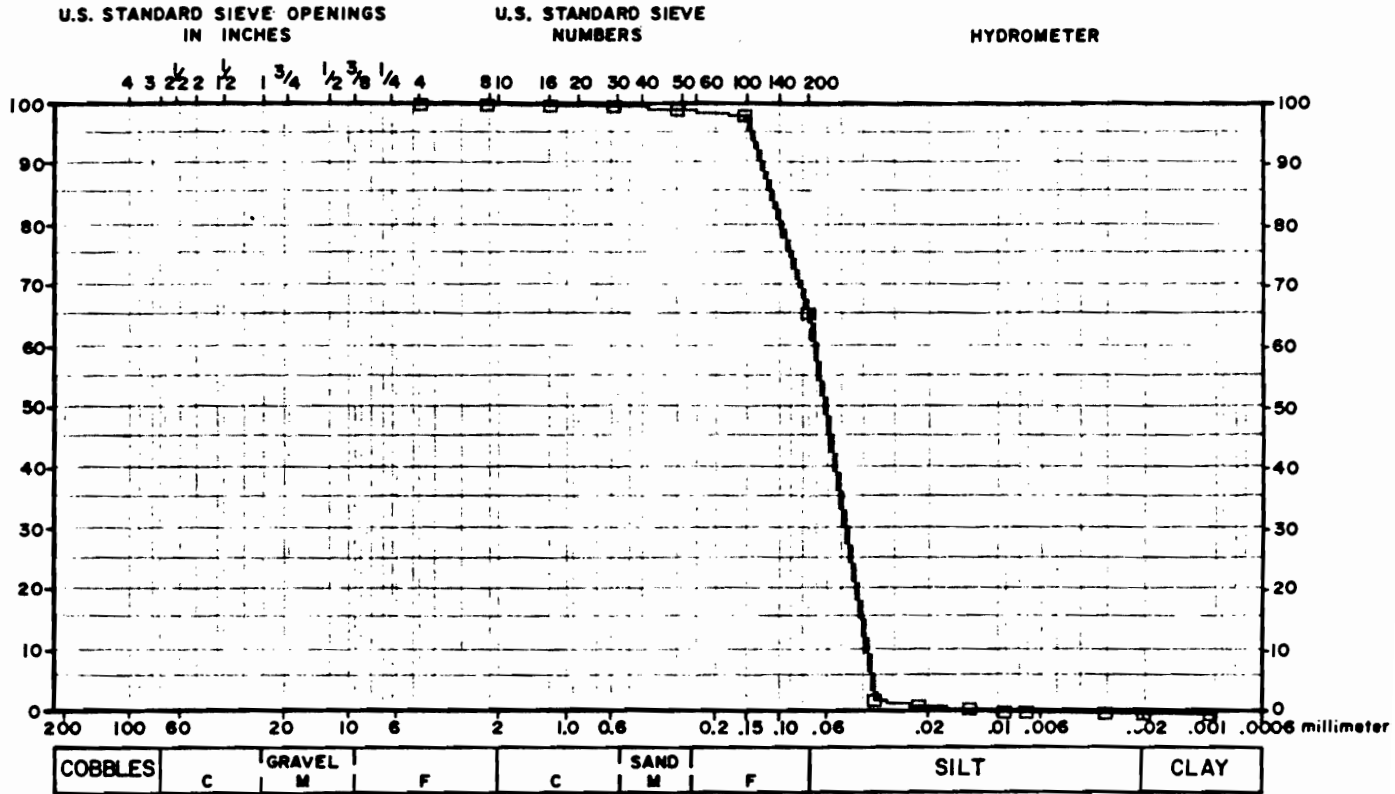

COARSE				FINE				HYDROMETER		
SIZE (Inches)	PERCENT RETAINED	CUMULATIVE PERCENT PASSING	SPECS.	SIEVE	PERCENT RETAINED	CUMULATIVE PERCENT PASSING	SPECS.	PARTICLE DIAMETER (mm)	PERCENT PASSING	SPECS.
				4	0.00	100.00		0.036	2.36	
				8	0.00	100.00		0.023	1.31	
				16	0.00	100.00		0.013	0.79	
				30	0.18	99.82		0.009	0.52	
				50	0.18	99.65		0.007	0.52	
				100	0.88	98.76		0.003	0.52	
				200	32.57	66.19		0.002	0.52	
								0.001	0.52	

Pan = 66.19%

Wash Loss Was Not Tested.

SPECIFICATION: ASTM C 136

TEST STANDARD:

NOTES: PER CENT MOISTURE 22.40% ASTM D 2216

Test Samples are retained for 30 days after submission and then discarded, unless other arrangements are made.

# Dunn Geoscience Laboratory

5 Northway Lane North, Latham, NY 12110 (518) 783-8102

CLIENT: URS (VOLNEY)  
 LAB NUMBER: 86-3-75/553-3-4337 DATE RECEIVED: 3/12/86  
 TEST BY: JWH DATE TESTED: 3/26/86  
 REVIEWED BY: *MJZ* DATE REPORTED: 4/7/86  
 SAMPLE DESCR: BW-8D, S-6, 10' - 12'

## GRAIN SIZE DISTRIBUTION

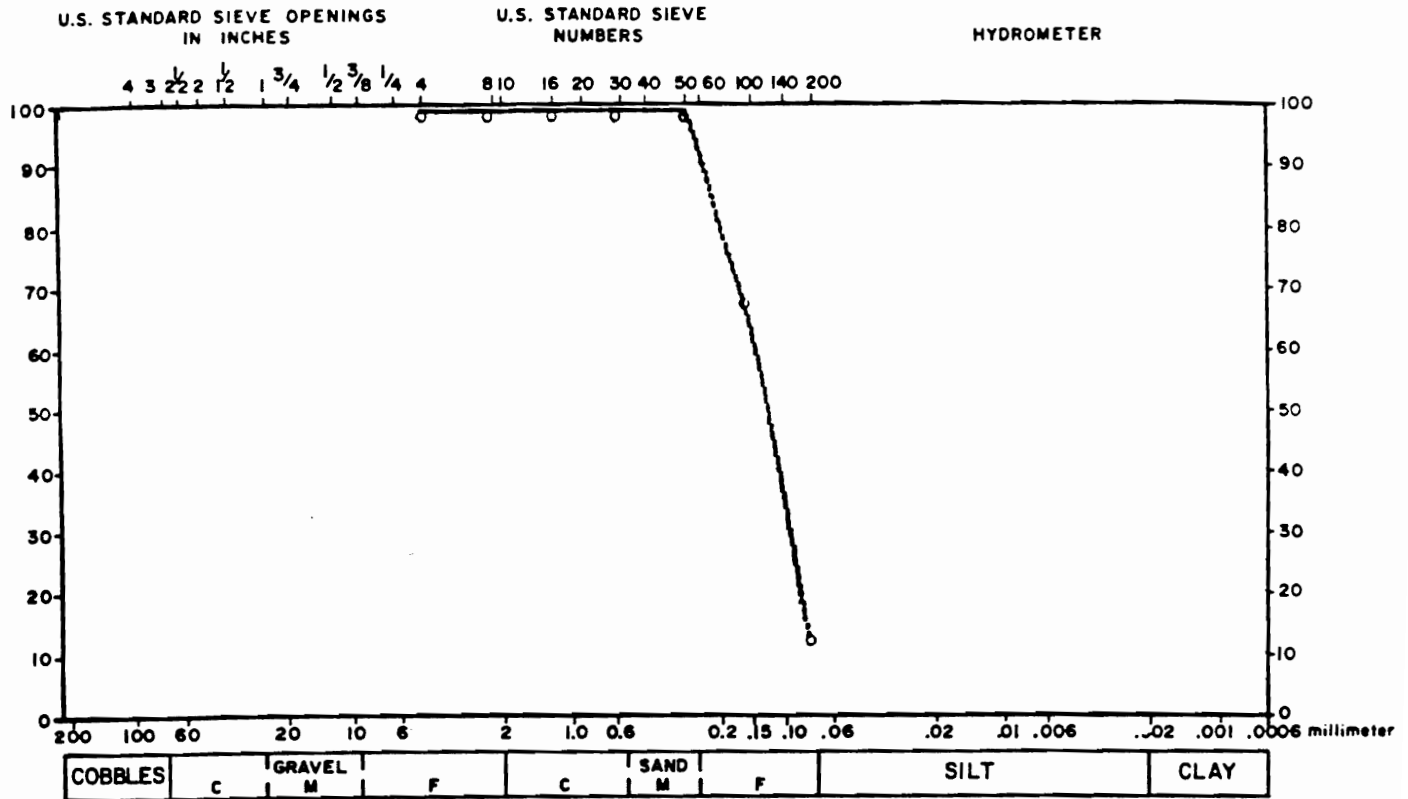

COARSE				FINE				HYDROMETER		
SIZE (Inches)	PERCENT RETAINED	CUMULATIVE PERCENT PASSING	SPECS.	SIEVE	PERCENT RETAINED	CUMULATIVE PERCENT PASSING	SPECS.	PARTICLE DIAMETER (mm)	PERCENT PASSING	SPECS.
-	0.00	0.00	-	4	0.00	100.00	-			
-	0.00	0.00	-	8	.02	99.98	-			
-	0.00	0.00	-	16	.02	99.96	-			
-	0.00	0.00	-	30	.05	99.91	-			
-	0.00	0.00	-	50	.11	99.80	-			
-	0.00	0.00	-	100	30.58	69.23	-			
-	0.00	0.00	-	200	55.84	13.38	-			
-	0.00	0.00	-	-	0.00	0.00	-			
-	0.00	0.00	-	-	0.00	0.00	-			
-	0.00	0.00	-	-	0.00	0.00	-			
-	0.00	0.00	-	-	0.00	0.00	-			
-	0.00	0.00	-	-	0.00	0.00	-			

PAN = 13.4%

WASH LOSS WAS NOT TESTED.

SPECIFICATION: ASTM C 136      ASTM D 2216

TEST STANDARD: NONE

NOTES:      MOISTURE - 24.89

Test samples are retained for 30 days after submission and then discarded, unless other arrangements are made.

# Dunn Geoscience Laboratory

5 Northway Lane North, Latham, NY 12110 (518) 783-8102

CLIENT: URS Volney  
 LAB NUMBER: 86-3-107/553-3-4337  
 TEST BY: JWH  
 REVIEWED BY: *mgz*  
 SAMPLE DESCR: BW-8D, S-12, 22'-24'

DATE RECEIVED: 3/12/86  
 DATE TESTED: 3/26/86  
 DATE REPORTED: 4/23/86

## GRAIN SIZE DISTRIBUTION

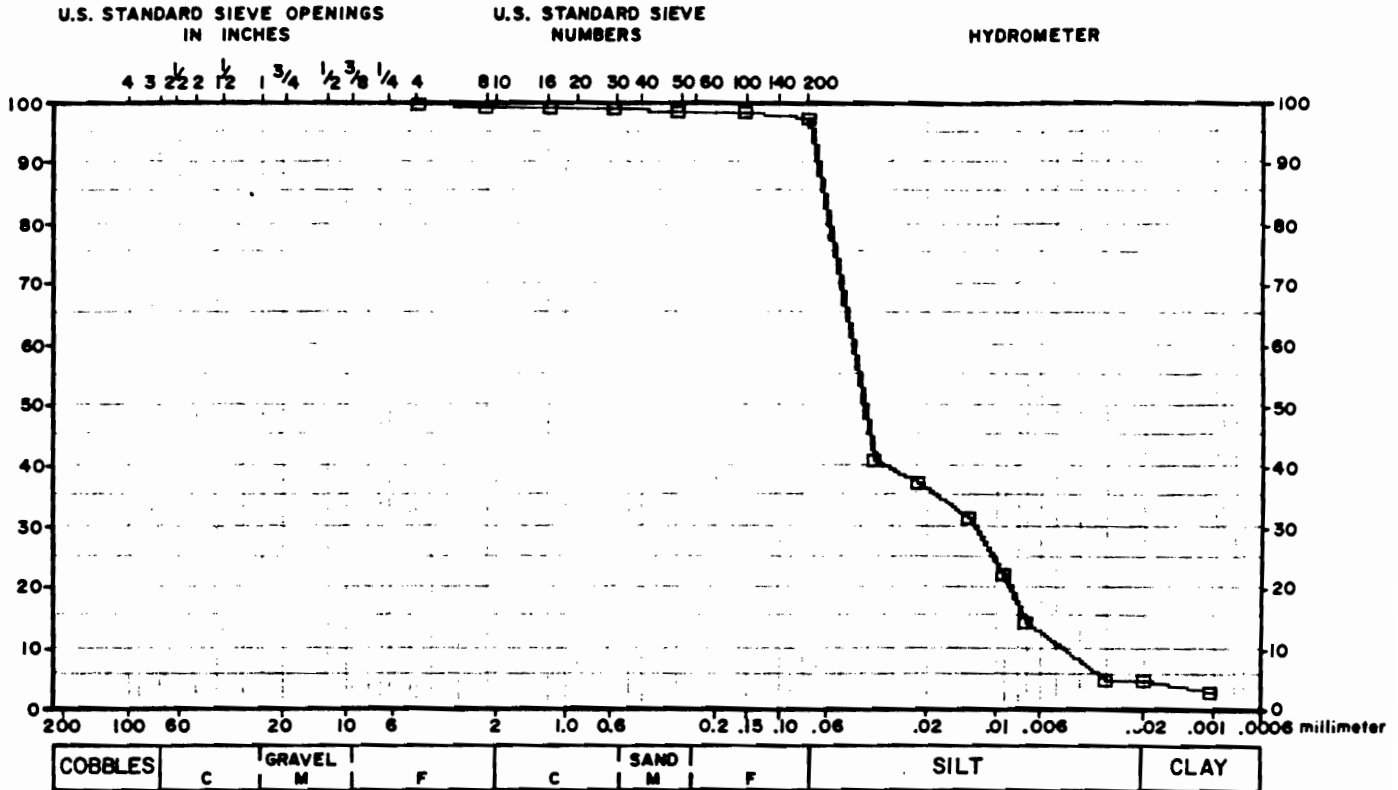

COARSE				FINE				HYDROMETER		
SIZE (Inches)	PERCENT RETAINED	CUMULATIVE PERCENT PASSING	SPECS.	SIEVE	PERCENT RETAINED	CUMULATIVE PERCENT PASSING	SPECS.	PARTICLE DIAMETER (mm)	PERCENT PASSING	SPECS.
				4	0.00	100.00		0.036	41.97	
				8	0.24	99.76		0.023	38.16	
				16	0.12	99.64		0.013	32.43	
				30	0.12	99.52		0.009	22.89	
				50	0.24	99.27		0.007	15.26	
				100	0.24	99.03		0.003	5.72	
				200	0.85	98.18		0.002	5.72	
								0.001	3.82	

Pan = 98.18%

Wash Loss Was Not Tested.

SPECIFICATION: ASTM C 136

TEST STANDARD:

NOTES: PER CENT MOISTURE 21.56% ASTM D 2216

Test Samples are retained for 30 days after submission and then discarded, unless other arrangements are made.



# Dunn Geoscience Laboratory

5 Northway Lane North, Latham, NY 12110 (518) 783-8102

CLIENT: URS VOLNEY

LAB NUMBER: 86-3-109

TEST BY: JWH

REVIEWED BY: *MJZ*

SAMPLE DESCR: BW-8D, S-14, 26'-28'

DATE RECEIVED: 3/12/86

DATE TESTED: 3/26/86

DATE REPORTED: 4/23/86

## GRAIN SIZE DISTRIBUTION

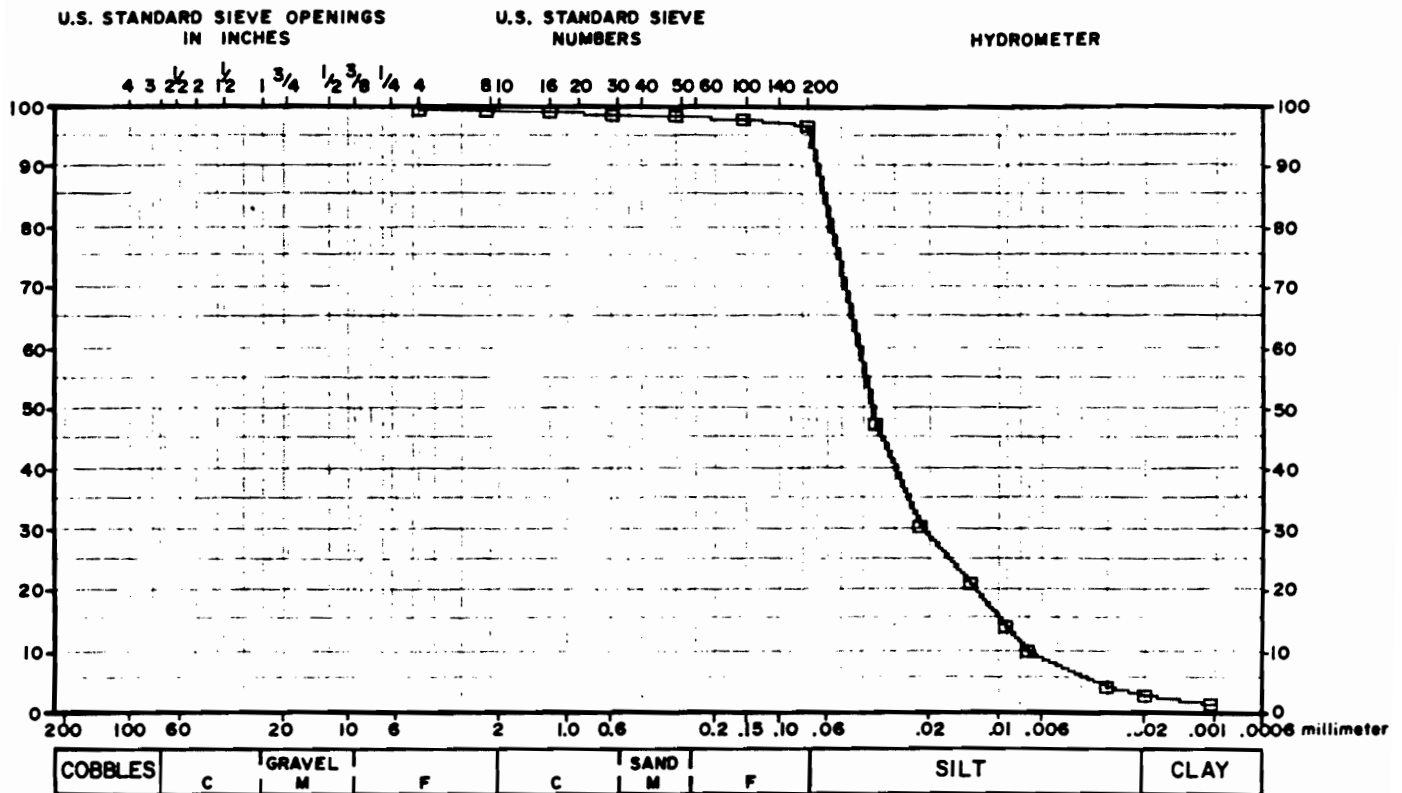

COARSE				FINE				HYDROMETER		
SIZE (Inches)	PERCENT RETAINED	CUMULATIVE PERCENT PASSING	SPECS.	SIEVE	PERCENT RETAINED	CUMULATIVE PERCENT PASSING	SPECS.	PARTICLE DIAMETER (mm)	PERCENT PASSING	SPECS.
				4	0.00	100.00		0.036	48.33	
				8	0.00	100.00		0.023	31.76	
				16	0.00	100.00		0.013	22.09	
				30	0.26	99.74		0.009	15.19	
				50	0.09	99.65		0.007	11.05	
				100	0.35	99.31		0.003	5.52	
				200	1.04	98.26		0.002	4.14	
								0.001	2.76	

Pan = 98.26%

Wash Loss Was Not Tested.

SPECIFICATION: ASTM C 136

TEST STANDARD:

NOTES: PER CENT MOISTURE 18.84%

Test Samples are retained for 30 days after submission and then discarded, unless other arrangements are made.

# Dunn Geoscience Laboratory

5 Northway Lane North, Latham, NY 12110 (518) 783-8102

CLIENT: URS VOLNEY	DATE RECEIVED: 3/12/86
LAB NUMBER: 86-3-110/553-3-4337	DATE TESTED: 3/26/86
TEST BY: JWH	DATE REPORTED: 4/23/86
REVIEWED BY: <i>MJZ</i>	
SAMPLE DESCR: BW-8D, S-15, 28'-30'	

## GRAIN SIZE DISTRIBUTION

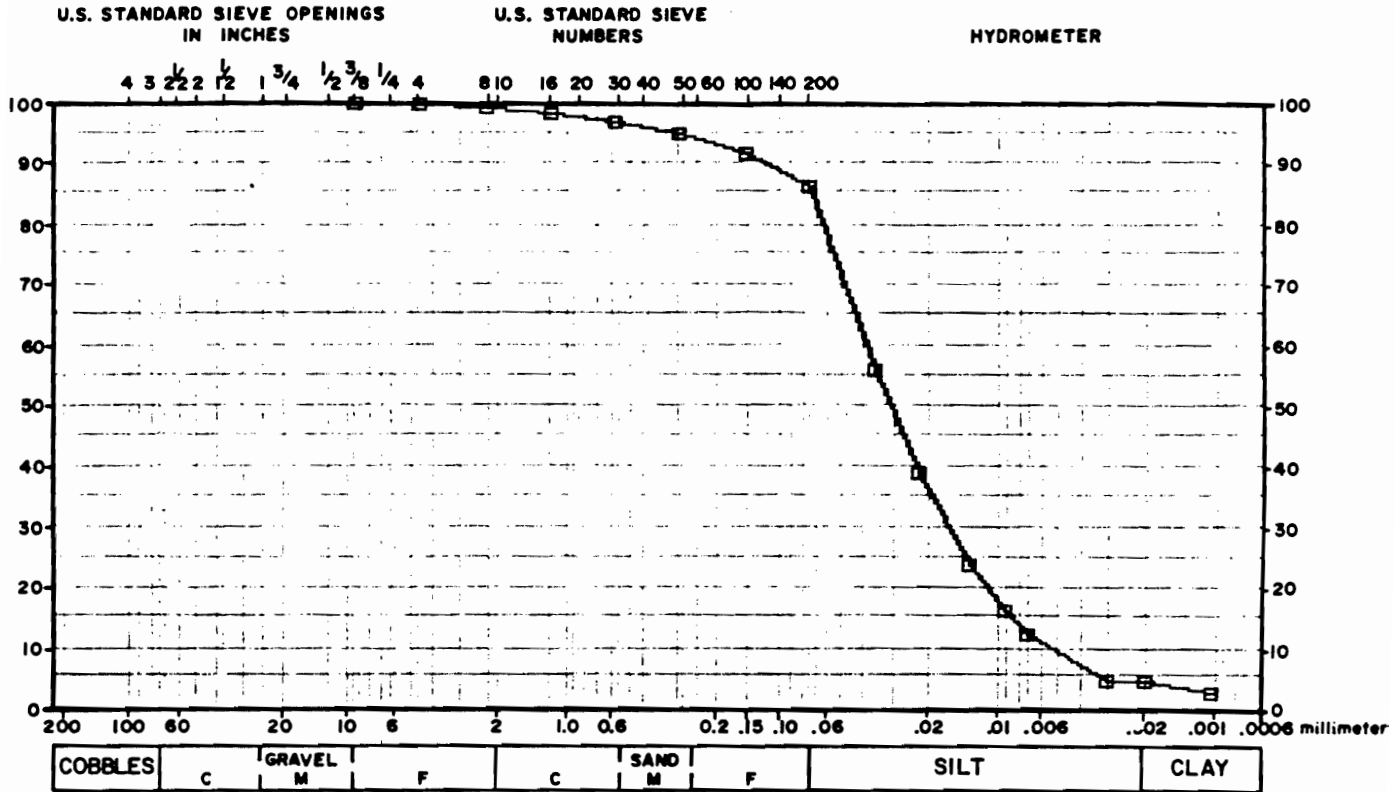

COARSE				FINE				HYDROMETER		
SIZE (Inches)	PERCENT RETAINED	CUMULATIVE PERCENT PASSING	SPECS.	SIEVE	PERCENT RETAINED	CUMULATIVE PERCENT PASSING	SPECS.	PARTICLE DIAMETER (mm)	PERCENT PASSING	SPECS.
				3/8	0.00	100.00		0.036	57.07	
				4	0.15	99.85		0.023	39.95	
				8	0.37	99.48		0.013	24.73	
				16	0.75	98.73		0.009	17.12	
				30	1.57	97.16		0.007	13.32	
				50	1.57	95.58		0.003	5.71	
				100	3.07	92.51		0.002	5.71	
				200	5.61	86.90		0.001	3.80	
				Pan = 86.90%						

Wash Loss Was Not Tested.

SPECIFICATION: ASTM C 136 ASTM D 422

TEST STANDARD:

NOTES: PER CENT MOISTURE 17.12% ASTM D 2216

Test Samples are retained for 30 days after submission and then discarded, unless other arrangements are made.

# Dunn Geoscience Laboratory

5 Northway Lane North, Latham, NY 12110 (518) 783-8102

CLIENT: URS (VOLNEY)  
 LAB NUMBER: 86-3-99/553-3-4337 DATE RECEIVED: 3/11/86  
 TEST BY: JWH DATE TESTED: 3/12/86  
 REVIEWED BY: *[Signature]* DATE REPORTED: 4/7/86  
 SAMPLE DESCR: BW-14, S-2, 9' - 11'

## GRAIN SIZE DISTRIBUTION

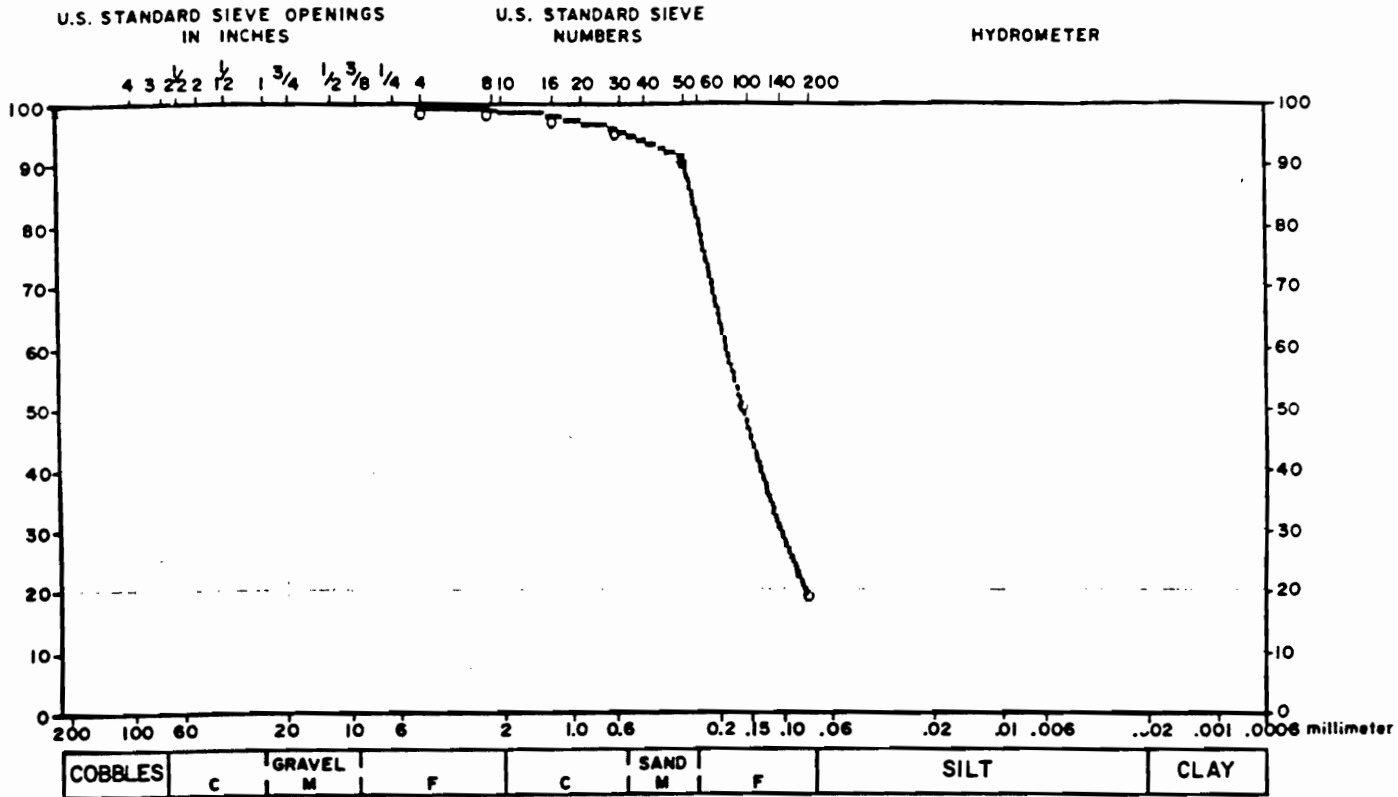

COARSE				FINE				HYDROMETER		
SIZE (Inches)	PERCENT RETAINED	CUMULATIVE PERCENT PASSING	SPECS.	SIEVE	PERCENT RETAINED	CUMULATIVE PERCENT PASSING	SPECS.	PARTICLE DIAMETER (mm)	PERCENT PASSING	SPECS.
-	0.00	0.00	-	4	0.00	100.00	-			
-	0.00	0.00	-	8	.16	99.84	-			
-	0.00	0.00	-	16	1.07	98.77	-			
-	0.00	0.00	-	30	1.95	96.82	-			
-	0.00	0.00	-	50	4.87	91.95	-			
-	0.00	0.00	-	100	40.09	51.85	-			
-	0.00	0.00	-	200	31.92	19.94	-			
-	0.00	0.00	-	-	0.00	0.00	-			
-	0.00	0.00	-	-	0.00	0.00	-			
-	0.00	0.00	-	-	0.00	0.00	-			
-	0.00	0.00	-	-	0.00	0.00	-			
-	0.00	0.00	-	-	0.00	0.00	-			

PAN = 19.9%

WASH LOSS WAS NOT TESTED.

SPECIFICATION: ASTM C 136 ASTM D 2216

TEST STANDARD: NONE

NOTES: MOISTURE - 25.43%

Test samples are retained for 30 days after submission and then discarded, unless other arrangements are made.

# Dunn Geoscience Laboratory

5 Northway Lane North, Latham, NY 12110 (518) 783 8102

CLIENT: URS (VOLNEY)  
 LAB NUMBER: 86-3-89/553-3-4337 DATE RECEIVED: 3/11/86  
 TEST BY: JWH DATE TESTED: 3/12/86  
 REVIEWED BY: *MJZ* DATE REPORTED: 4/7/86  
 SAMPLE DESCR: BW-15, S-2, 9' - 11'

## GRAIN SIZE DISTRIBUTION

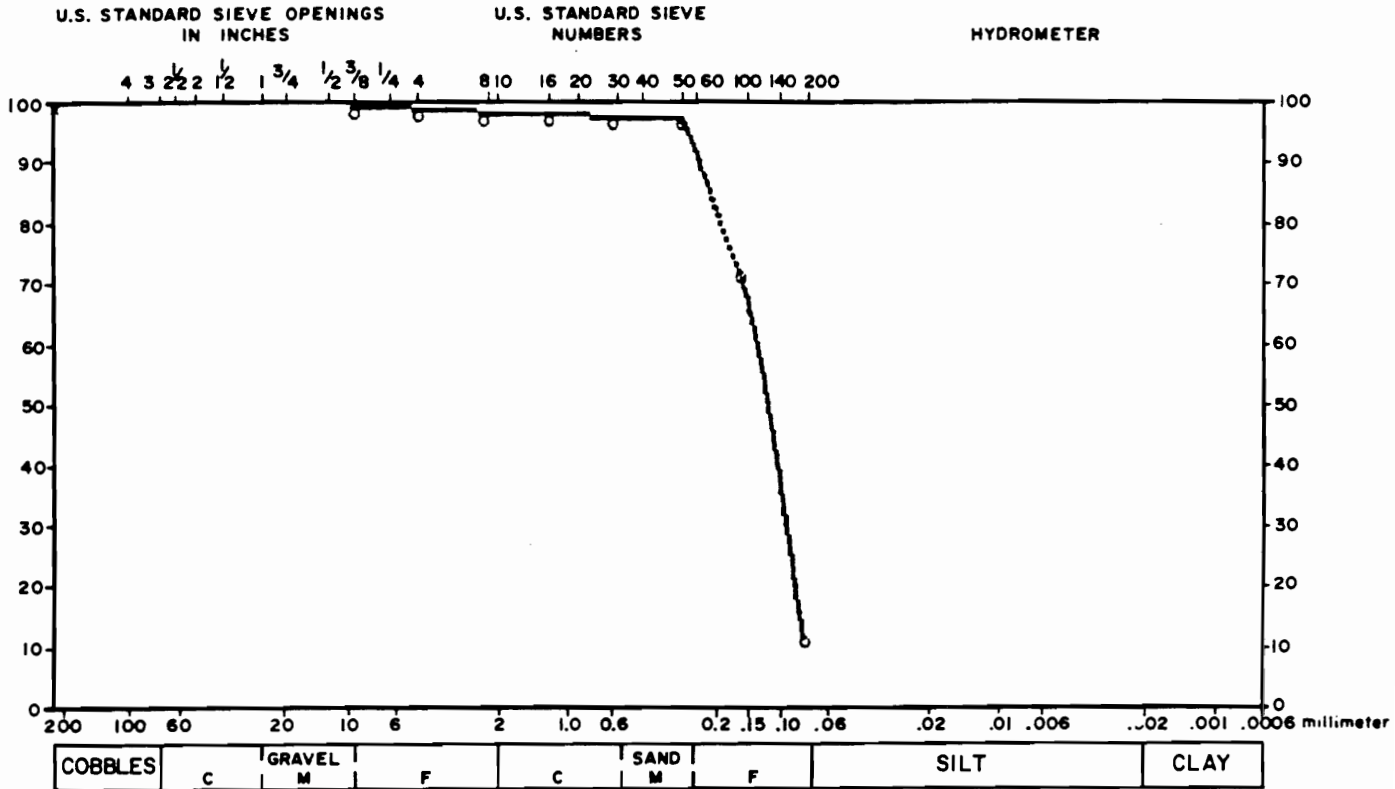

COARSE				FINE				HYDROMETER		
SIZE (Inches)	PERCENT RETAINED	CUMULATIVE PERCENT PASSING	SPECS.	SIEVE	PERCENT RETAINED	CUMULATIVE PERCENT PASSING	SPECS.	PARTICLE DIAMETER (mm)	PERCENT PASSING	SPECS.
-	0.00	0.00	-	3/8	0.00	100.00	-			
-	0.00	0.00	-	4	.37	99.63	-			
-	0.00	0.00	-	8	.65	98.98	-			
-	0.00	0.00	-	16	.43	98.55	-			
-	0.00	0.00	-	30	.31	98.24	-			
-	0.00	0.00	-	50	.51	97.73	-			
-	0.00	0.00	-	100	24.82	72.91	-			
-	0.00	0.00	-	200	60.83	12.08	-			
-	0.00	0.00	-	-	0.00	0.00	-			
-	0.00	0.00	-	-	0.00	0.00	-			
-	0.00	0.00	-	-	0.00	0.00	-			
-	0.00	0.00	-	-	0.00	0.00	-			

PAN = 12.1%  
 WASH LOSS WAS NOT TESTED.

SPECIFICATION: ASTM C 136      ASTM D 2216

TEST STANDARD: NONE

NOTES:                      MOISTURE - 24.17%

Test samples are retained for 30 days after submission and then discarded, unless other arrangements are made.

# Dunn Geoscience Laboratory

5 Northway Lane North, Latham, NY 12110 (518) 783-8102

CLIENT: URS (VOLNEY)  
 LAB NUMBER: 86-3-78/553-3-4337 DATE RECEIVED: 3/12/86  
 TEST BY: JWH DATE TESTED: 3/26/86  
 REVIEWED BY: *ngv* DATE REPORTED: 4/7/86  
 SAMPLE DESCR: BW-1, S-3, 14'-16'

## GRAIN SIZE DISTRIBUTION

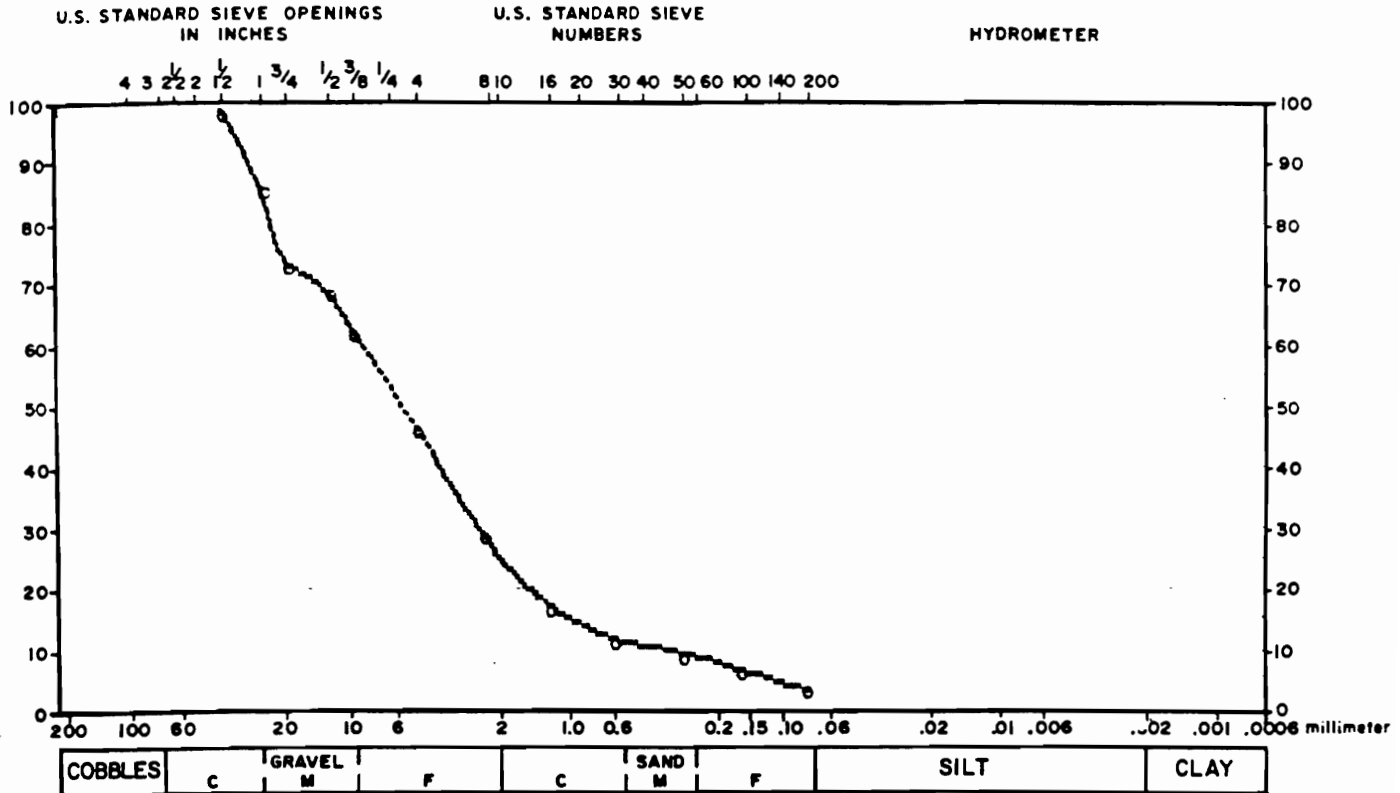

COARSE				FINE				HYDROMETER		
SIZE (Inches)	PERCENT RETAINED	CUMULATIVE PERCENT PASSING	SPECS.	SIEVE	PERCENT RETAINED	CUMULATIVE PERCENT PASSING	SPECS.	PARTICLE DIAMETER (mm)	PERCENT PASSING	SPECS.
1.5	0.00	100.00	-	4	15.96	47.38	-			
1	12.65	87.35	-	8	17.61	29.76	-			
3/4	12.87	74.47	-	16	11.78	17.99	-			
1/2	4.19	70.28	-	30	5.28	12.71	-			
3/8	6.95	63.33	-	50	2.42	10.29	-			
-	0.00	0.00	-	100	3.07	7.22	-			
-	0.00	0.00	-	200	3.04	4.18	-			
-	0.00	0.00	-	-	0.00	0.00	-			
-	0.00	0.00	-	-	0.00	0.00	-			
-	0.00	0.00	-	-	0.00	0.00	-			
-	0.00	0.00	-	-	0.00	0.00	-			
-	0.00	0.00	-	-	0.00	0.00	-			

PAN = 4.2%

WASH LOSS WAS NOT TESTED.

SPECIFICATION: ASTM C 136      ASTM D 2216

TEST STANDARD: NONE

NOTES:      MOISTURE - 3.91%

Test samples are retained for 30 days after submission and then discarded, unless other arrangements are made.

# Dunn Geoscience Laboratory

5 Northway Lane North, Latham, NY 12110 (518) 783-8102

CLIENT: URS (VOLNEY)  
 LAB NUMBER: 86-3-93/553-3-4337 DATE RECEIVED: 3/11/86  
 TEST BY: JWH DATE TESTED: 3/12/86  
 REVIEWED BY: *MJS* DATE REPORTED: 4/7/86  
 SAMPLE DESCR: BW-3, S-2, 2'-4'

## GRAIN SIZE DISTRIBUTION

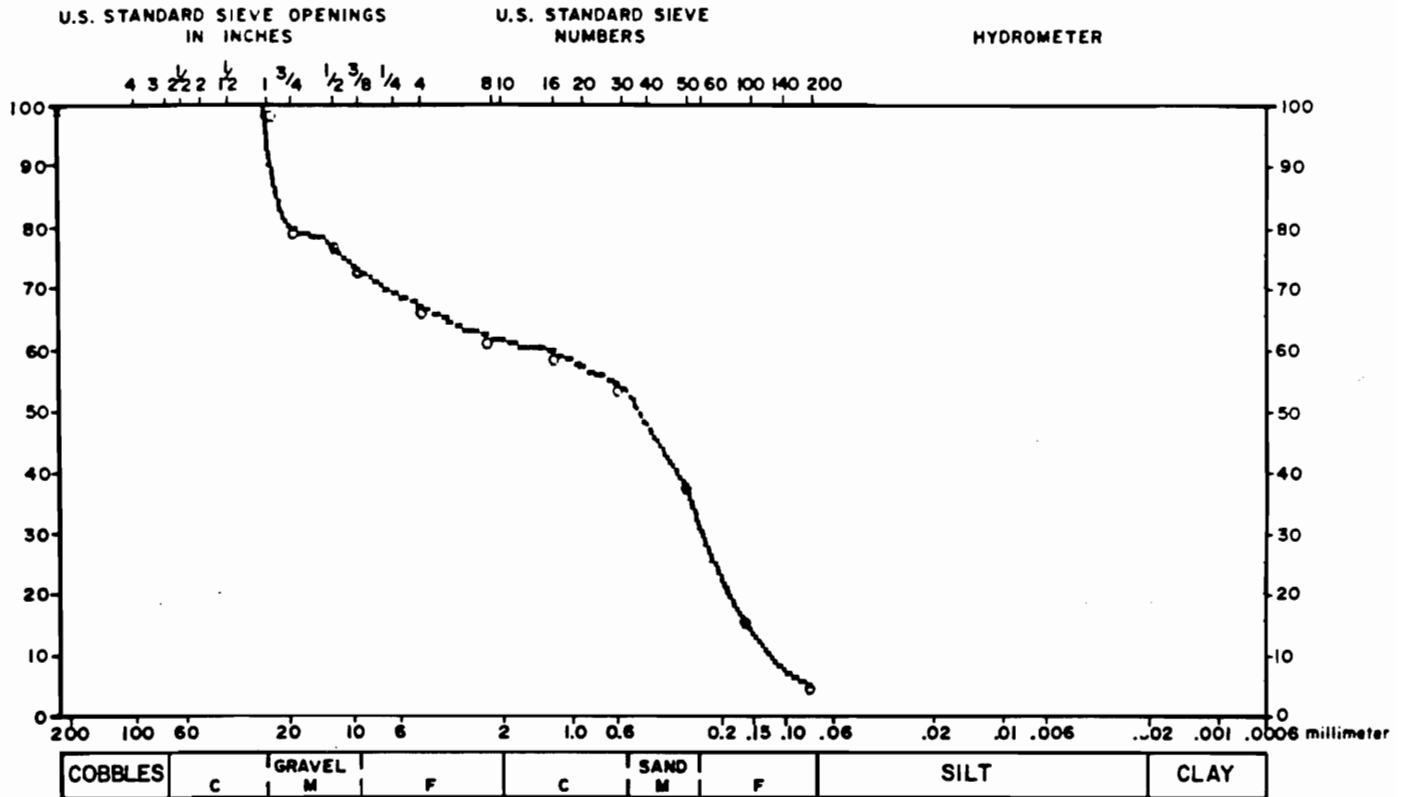

COARSE				FINE				HYDROMETER		
SIZE (Inches)	PERCENT RETAINED	CUMULATIVE PERCENT PASSING	SPECS.	SIEVE	PERCENT RETAINED	CUMULATIVE PERCENT PASSING	SPECS.	PARTICLE DIAMETER (mm)	PERCENT PASSING	SPECS.
1	0.00	100.00	-	4	6.57	67.31	-			
3/4	19.62	80.39	-	8	4.69	62.62	-			
1/2	2.14	78.24	-	16	2.72	59.90	-			
3/8	4.36	73.88	-	30	4.98	54.92	-			
-	0.00	0.00	-	50	16.42	38.50	-			
-	0.00	0.00	-	100	21.87	16.64	-			
-	0.00	0.00	-	200	11.62	5.01	-			
-	0.00	0.00	-	-	0.00	0.00	-			
-	0.00	0.00	-	-	0.00	0.00	-			
-	0.00	0.00	-	-	0.00	0.00	-			
-	0.00	0.00	-	-	0.00	0.00	-			
-	0.00	0.00	-	-	0.00	0.00	-			
-	0.00	0.00	-	-	0.00	0.00	-			

PAN = 4.8%  
 WASH LOSS WAS NOT TESTED.

SPECIFICATION: ASTM C 136 ASTM D 2216  
 TEST STANDARD: NONE  
 NOTES: MOISTURE - 8.28%  
 Test samples are retained for 30 days after submission and then discarded, unless other arrangements are made.

# Dunn Geoscience Laboratory

5 Northway Lane North, Latham, NY 12110 (518) 783-8102

CLIENT: URS (VOLNEY)  
 LAB NUMBER: 86-3-95/553-3-4337 DATE RECEIVED: 3/11/86  
 TEST BY: JWH DATE TESTED: 3/12/86  
 REVIEWED BY: *MJS* DATE REPORTED: 4/7/86  
 SAMPLE DESCR: BW-4, S-3, 10'-12'

## GRAIN SIZE DISTRIBUTION

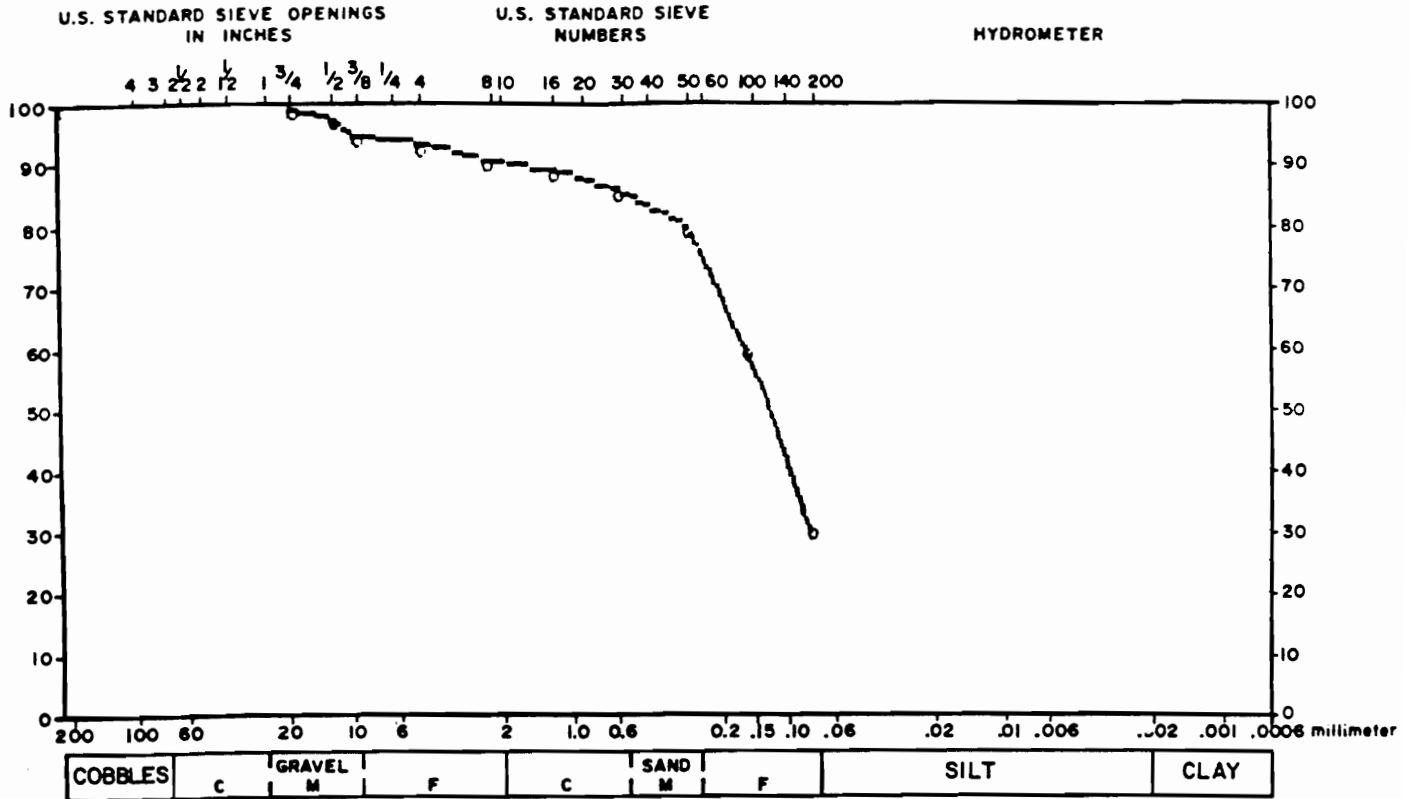

COARSE				FINE				HYDROMETER		
SIZE (Inches)	PERCENT RETAINED	CUMULATIVE PERCENT PASSING	SPECS.	SIEVE	PERCENT RETAINED	CUMULATIVE PERCENT PASSING	SPECS.	PARTICLE DIAMETER (mm)	PERCENT PASSING	SPECS.
3/4	0.00	100.00	-	4	1.35	94.27	-			
1/2	1.60	98.40	-	8	2.65	91.62	-			
3/8	2.78	95.62	-	16	1.77	89.85	-			
-	0.00	0.00	-	30	3.03	86.82	-			
-	0.00	0.00	-	50	6.40	80.42	-			
-	0.00	0.00	-	100	19.79	60.63	-			
-	0.00	0.00	-	200	30.06	30.57	-			
-	0.00	0.00	-	-	0.00	0.00	-			
-	0.00	0.00	-	-	0.00	0.00	-			
-	0.00	0.00	-	-	0.00	0.00	-			
-	0.00	0.00	-	-	0.00	0.00	-			
-	0.00	0.00	-	-	0.00	0.00	-			

PAN = 30.6%  
 WASH LOSS WAS NOT TESTED.

SPECIFICATION: ASTM C 136      ASTM D 2216

TEST STANDARD: NONE

NOTES:                      MOISTURE - 15.96%

Test samples are retained for 30 days after submission and then discarded, unless other arrangements are made.

# Dunn Geoscience Laboratory

5 Northway Lane North, Latham, NY 12110 (518) 783-8102

CLIENT: URS (VOLNEY)  
 LAB NUMBER: 86-3-91/553-3-4337 DATE RECEIVED: 3/11/86  
 TEST BY: JWH DATE TESTED: 3/12/86  
 REVIEWED BY: *[Signature]* DATE REPORTED: 4/7/86  
 SAMPLE DESCR: BW-6, S-3, 10'-12'

## GRAIN SIZE DISTRIBUTION

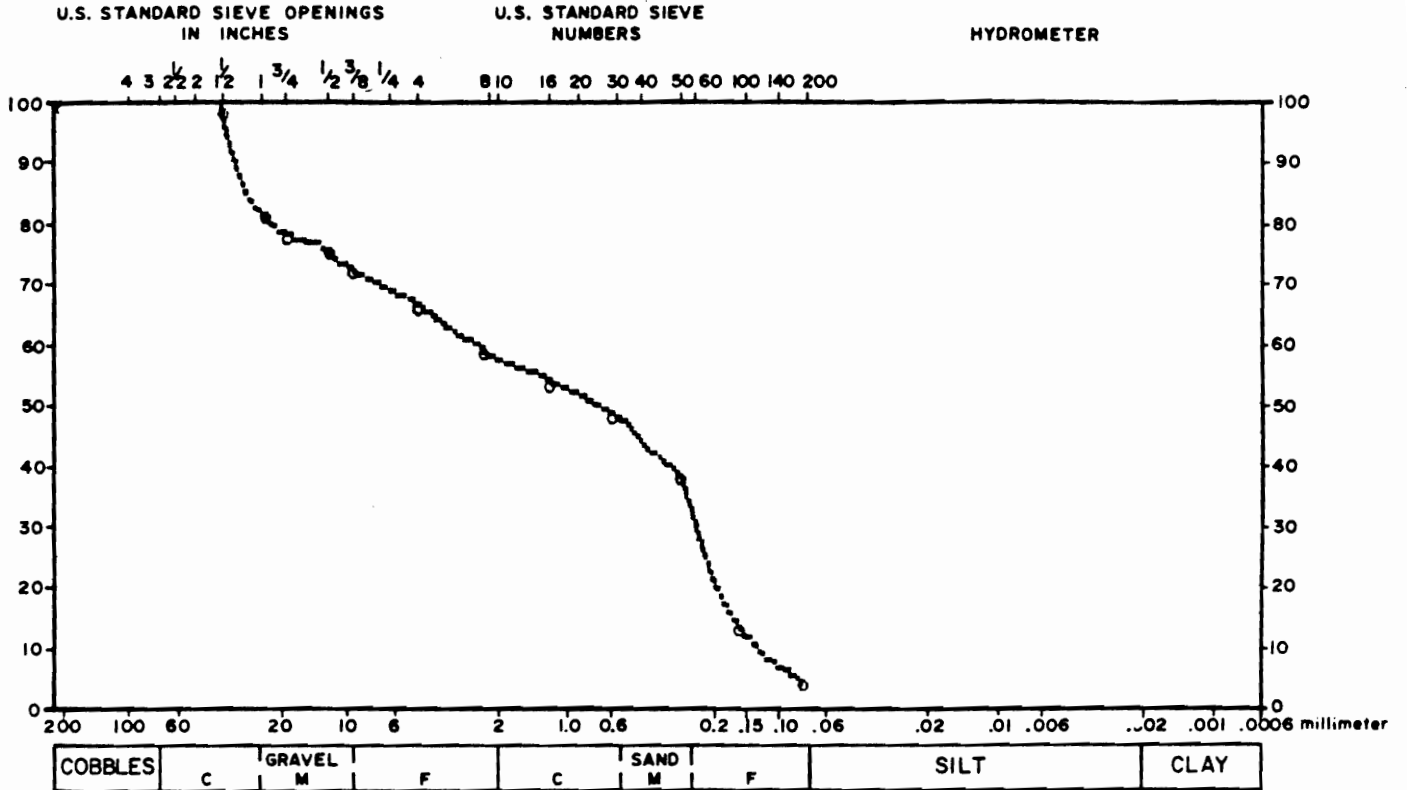

COARSE				FINE				HYDROMETER		
SIZE (Inches)	PERCENT RETAINED	CUMULATIVE PERCENT PASSING	SPECS.	SIEVE	PERCENT RETAINED	CUMULATIVE PERCENT PASSING	SPECS.	PARTICLE DIAMETER (mm)	PERCENT PASSING	SPECS.
1.5	0.00	100.00	-	4	5.66	67.44	-			
1	17.63	82.38	-	8	7.75	59.69	-			
3/4	3.28	79.09	-	16	4.88	54.81	-			
1/2	2.50	76.59	-	30	5.34	49.47	-			
3/8	3.50	73.09	-	50	10.28	39.19	-			
-	0.00	0.00	-	100	24.59	14.59	-			
-	0.00	0.00	-	200	9.72	4.88	-			
-	0.00	0.00	-	-	0.00	0.00	-			
-	0.00	0.00	-	-	0.00	0.00	-			
-	0.00	0.00	-	-	0.00	0.00	-			
-	0.00	0.00	-	-	0.00	0.00	-			
-	0.00	0.00	-	-	0.00	0.00	-			

PAN = 4.9%  
 WASH LOSS WAS NOT TESTED.

SPECIFICATION: ASTM C 136      ASTM D 2216

TEST STANDARD: NONE

NOTES:                      MOISTURE - 13.13%

Test samples are retained for 30 days after submission and then discarded, unless other arrangements are made.



# Dunn Geoscience Laboratory

5 Northway Lane North, Latham, NY 12110 (518) 783-8102

CLIENT: URS (VOLNEY)  
 LAB NUMBER: 86-3-87/553-3-4337 DATE RECEIVED: 3/11/86  
 TEST BY: JWH DATE TESTED: 3/12/86  
 REVIEWED BY: *[Signature]* DATE REPORTED: 4/7/86  
 SAMPLE DESCR: BW-6, S-4, 15' - 17'

## GRAIN SIZE DISTRIBUTION

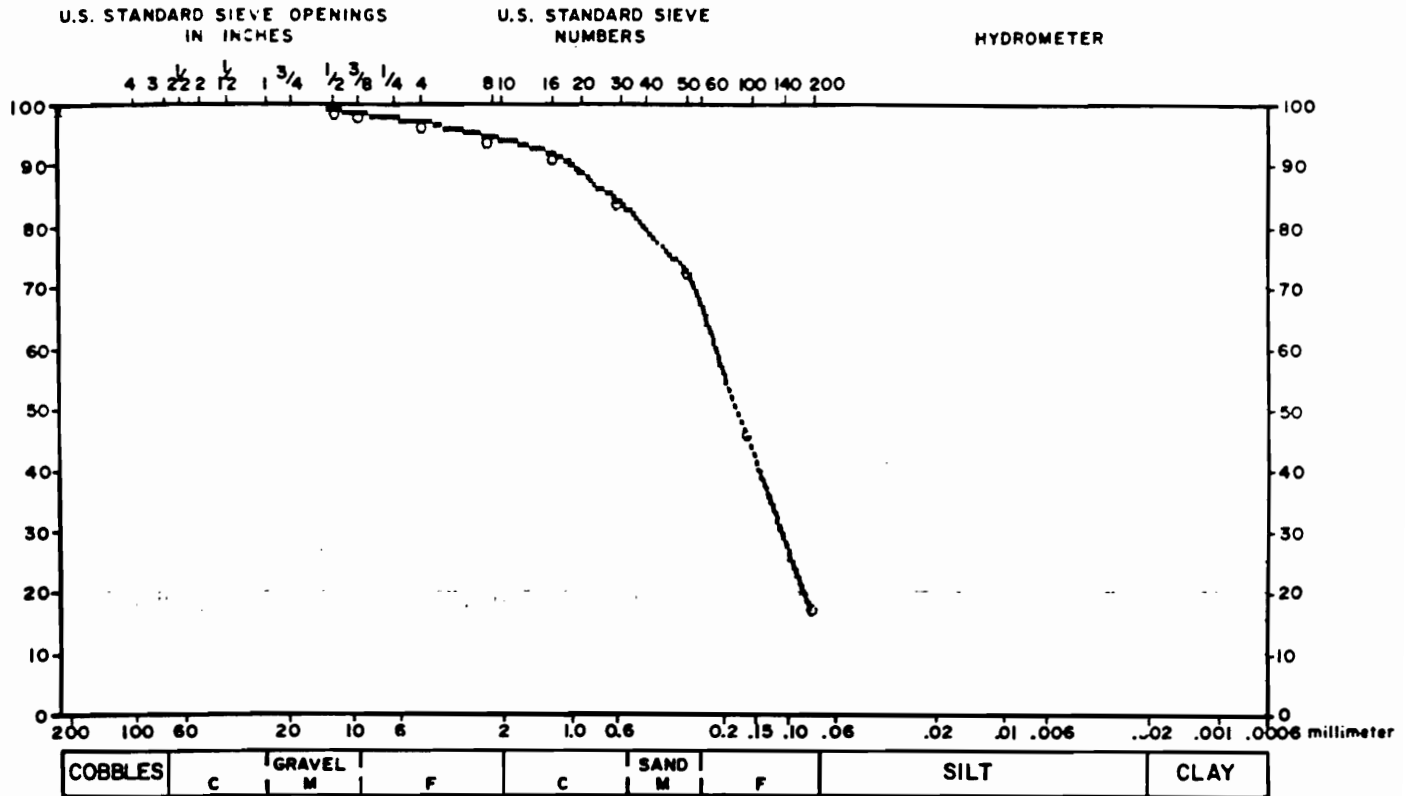

COARSE				FINE				HYDROMETER		
SIZE (Inches)	PERCENT RETAINED	CUMULATIVE PERCENT PASSING	SPECS.	SIEVE	PERCENT RETAINED	CUMULATIVE PERCENT PASSING	SPECS.	PARTICLE DIAMETER (mm)	PERCENT PASSING	SPECS.
1/2	0.00	100.00	-	4	1.45	97.89	-			
3/8	.66	99.34	-	8	2.28	95.61	-			
-	0.00	0.00	-	16	2.97	92.64	-			
-	0.00	0.00	-	30	7.43	85.21	-			
-	0.00	0.00	-	50	11.52	73.69	-			
-	0.00	0.00	-	100	26.41	47.28	-			
-	0.00	0.00	-	200	29.05	18.22	-			
-	0.00	0.00	-	-	0.00	0.00	-			
-	0.00	0.00	-	-	0.00	0.00	-			
-	0.00	0.00	-	-	0.00	0.00	-			
-	0.00	0.00	-	-	0.00	0.00	-			
-	0.00	0.00	-	-	0.00	0.00	-			

PAN = 18.2%  
 WASH LOSS WAS NOT TESTED.

SPECIFICATION: ASTM C 136      ASTM D 2216

TEST STANDARD: NONE

NOTES:                      MOISTURE - 18.32%

Test samples are retained for 30 days after submission and then discarded, unless other arrangements are made.

# Dunn Geoscience Laboratory

5 Northway Lane North, Latham, NY 12110 (518) 783-8102

CLIENT: URS (VOLNEY)  
 LAB NUMBER: 86-3-90/553-3-4337 DATE RECEIVED: 3/11/86  
 TEST BY: JWH DATE TESTED: 3/12/86  
 REVIEWED BY: *MJZ* DATE REPORTED: 4/7/86  
 SAMPLE DESCR: BW-11, S-4, 15' - 17'

## GRAIN SIZE DISTRIBUTION

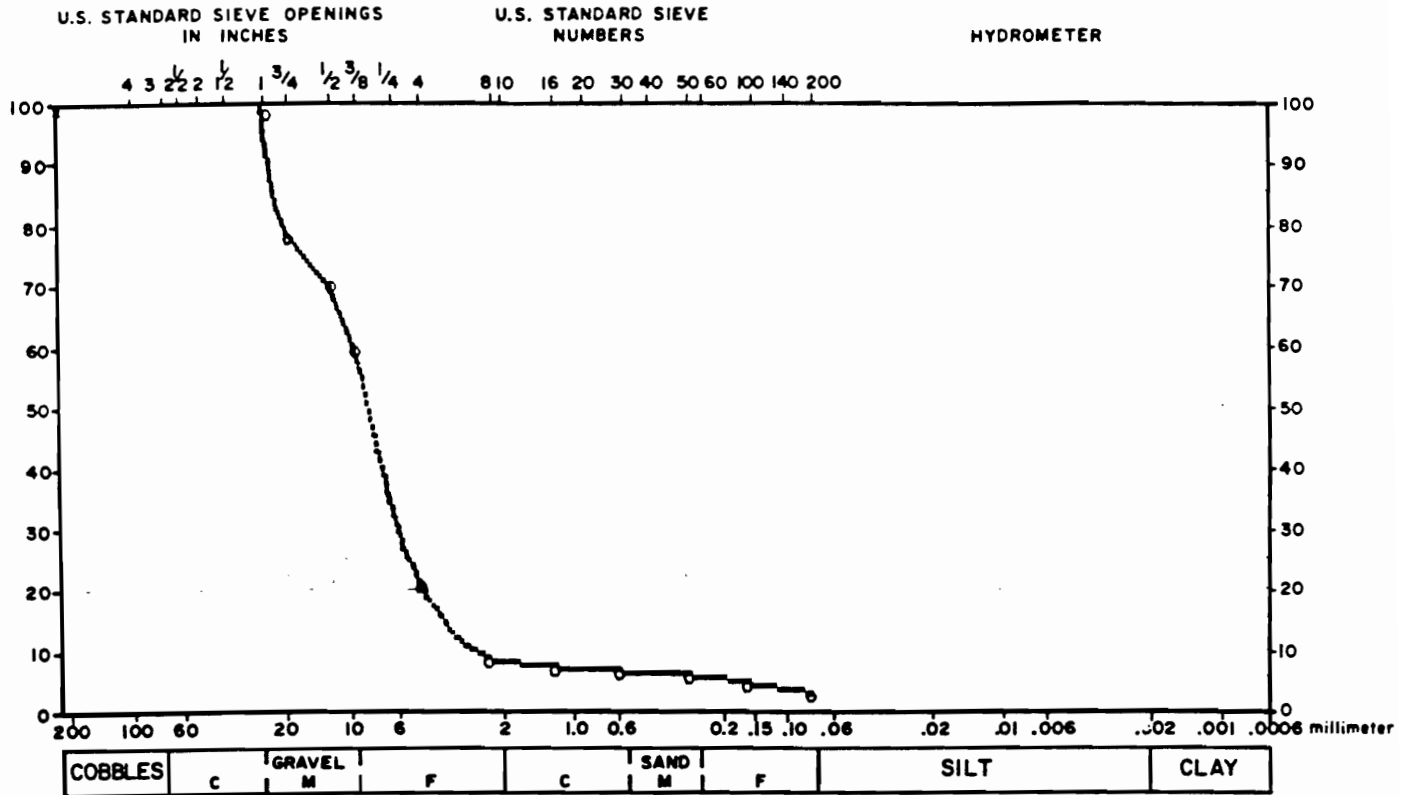

COARSE				FINE				HYDROMETER		
SIZE (Inches)	PERCENT RETAINED	CUMULATIVE PERCENT PASSING	SPECS.	SIEVE	PERCENT RETAINED	CUMULATIVE PERCENT PASSING	SPECS.	PARTICLE DIAMETER (mm)	PERCENT PASSING	SPECS.
1	0.00	100.00	-	4	38.87	21.94	-			
3/4	20.79	79.21	-	8	12.90	9.04	-			
1/2	8.00	71.20	-	16	1.31	7.73	-			
3/8	10.40	60.81	-	30	.71	7.02	-			
-	0.00	0.00	-	50	.60	6.42	-			
-	0.00	0.00	-	100	1.25	5.17	-			
-	0.00	0.00	-	200	1.74	3.43	-			
-	0.00	0.00	-	-	0.00	0.00	-			
-	0.00	0.00	-	-	0.00	0.00	-			
-	0.00	0.00	-	-	0.00	0.00	-			
-	0.00	0.00	-	-	0.00	0.00	-			
-	0.00	0.00	-	-	0.00	0.00	-			
-	0.00	0.00	-	-	0.00	0.00	-			

PAN = 3.2%  
 WASH LOSS WAS NOT TESTED.

SPECIFICATION: ASTM C 136      ASTM D 2216  
 TEST STANDARD: NONE  
 NOTES:                      MOISTURE - 7.13%  
 Test samples are retained for 30 days after submission and then discarded, unless other arrangements are made.

# Dunn Geoscience Laboratory

5 Northway Lane North, Latham, NY 12110 (518) 783-8102

CLIENT: URS (VOLNEY)  
 LAB NUMBER: 86-3-106/553-3-4337 DATE RECEIVED: 3/11/86  
 TEST BY: JWH DATE TESTED: 3/12/86  
 REVIEWED BY: *MJZ* DATE REPORTED: 4/7/86  
 SAMPLE DESCR: BW-11, S-5, 20' - 22'

## GRAIN SIZE DISTRIBUTION

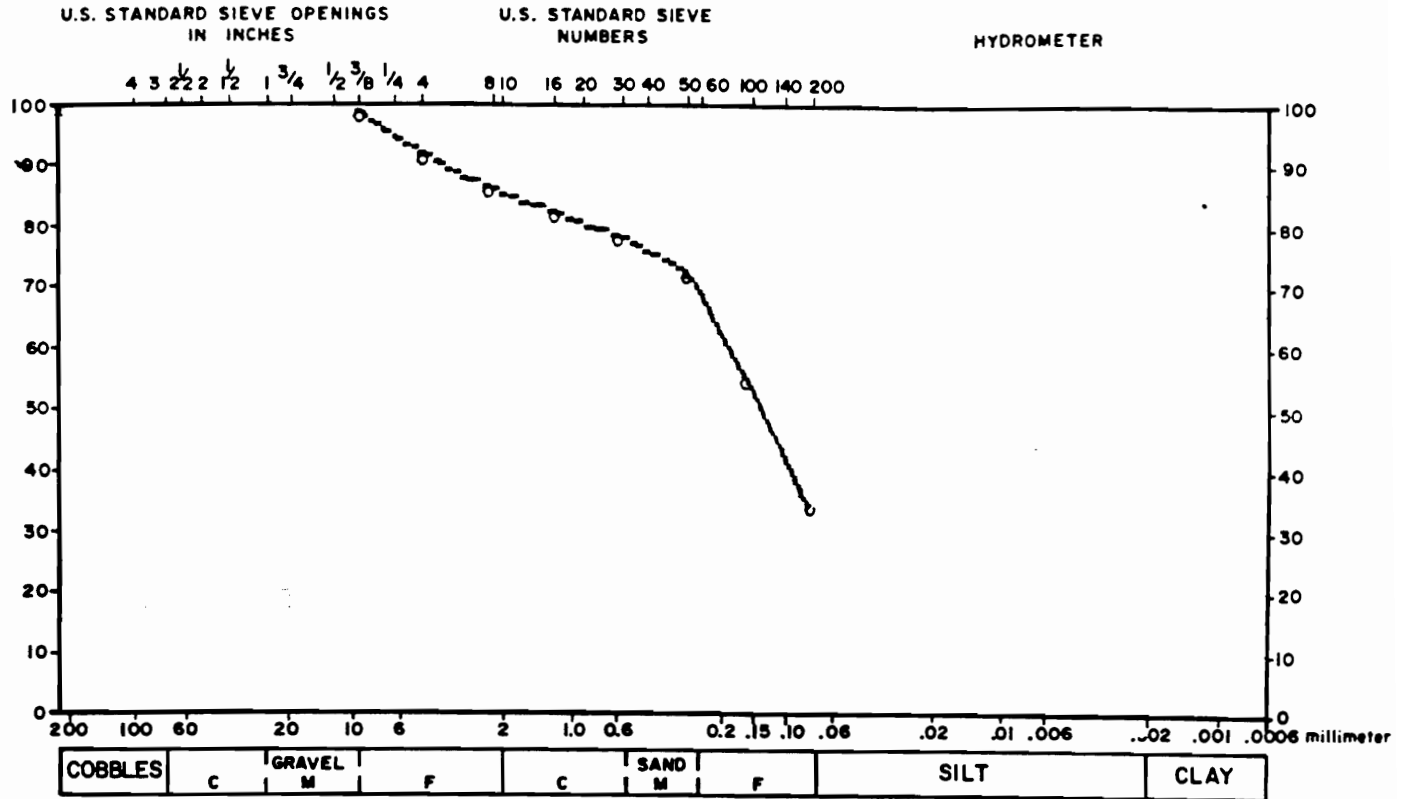

COARSE				FINE				HYDROMETER		
SIZE (Inches)	PERCENT RETAINED	CUMULATIVE PERCENT PASSING	SPECS.	SIEVE	PERCENT RETAINED	CUMULATIVE PERCENT PASSING	SPECS.	PARTICLE DIAMETER (mm)	PERCENT PASSING	SPECS.
-	0.00	0.00	-	3/8	0.00	100.00	-			
-	0.00	0.00	-	4	7.16	92.84	-			
-	0.00	0.00	-	8	5.70	87.13	-			
-	0.00	0.00	-	16	3.87	83.26	-			
-	0.00	0.00	-	30	3.87	79.39	-			
-	0.00	0.00	-	50	5.92	73.46	-			
-	0.00	0.00	-	100	17.25	56.21	-			
-	0.00	0.00	-	200	21.42	34.80	-			
-	0.00	0.00	-	-	0.00	0.00	-			
-	0.00	0.00	-	-	0.00	0.00	-			
-	0.00	0.00	-	-	0.00	0.00	-			
-	0.00	0.00	-	-	0.00	0.00	-			

PAN = 34.8%  
 WASH LOSS WAS NOT TESTED.

SPECIFICATION: ASTM C 136      ASTM D 2216

TEST STANDARD: NONE

NOTES:      MOISTURE - 9.06%

Test samples are retained for 30 days after submission and then discarded, unless other arrangements are made.

# Dunn Geoscience Laboratory

5 Northway Lane North, Latham, NY 12110 (518) 783-8102

CLIENT: URS (VOLNEY)  
 LAB NUMBER: 86-3-104/553-3-4337 DATE RECEIVED: 3/11/86  
 TEST BY: JWH DATE TESTED: 3/12/86  
 REVIEWED BY: *Mgz* DATE REPORTED: 4/7/86  
 SAMPLE DESCR: BW-12, S-2, 9'-11'

## GRAIN SIZE DISTRIBUTION

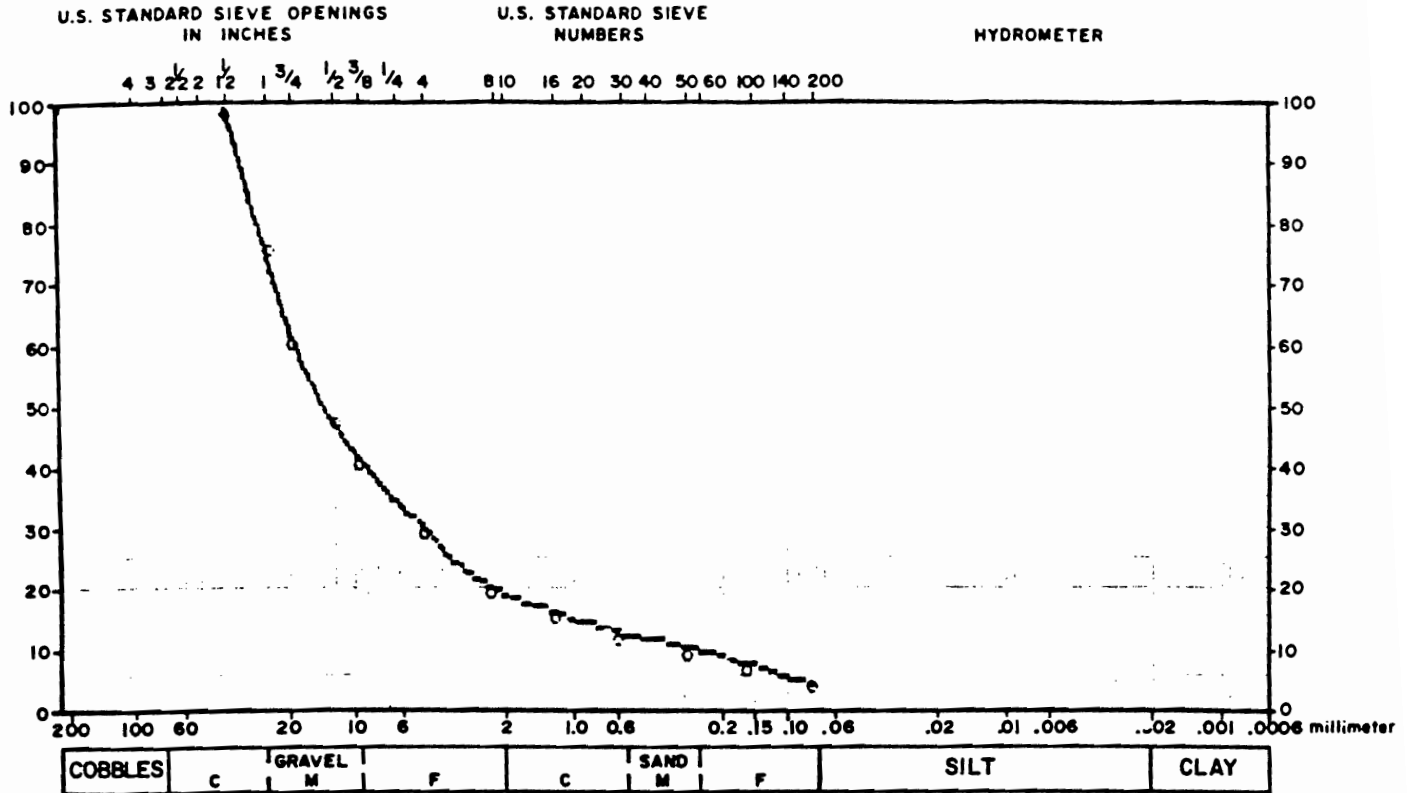

COARSE				FINE				HYDROMETER		
SIZE (Inches)	PERCENT RETAINED	CUMULATIVE PERCENT PASSING	SPECS.	SIEVE	PERCENT RETAINED	CUMULATIVE PERCENT PASSING	SPECS.	PARTICLE DIAMETER (mm)	PERCENT PASSING	SPECS.
1.5	0.00	100.00	-	4	11.54	30.63	-			
1	22.94	77.06	-	8	10.15	20.48	-			
3/4	14.73	62.33	-	16	3.92	16.56	-			
1/2	13.74	48.59	-	30	3.44	13.12	-			
3/8	6.41	42.18	-	50	2.20	10.92	-			
-	0.00	0.00	-	100	2.60	8.32	-			
-	0.00	0.00	-	200	3.59	4.73	-			
-	0.00	0.00	-	-	0.00	0.00	-			
-	0.00	0.00	-	-	0.00	0.00	-			
-	0.00	0.00	-	-	0.00	0.00	-			
-	0.00	0.00	-	-	0.00	0.00	-			
-	0.00	0.00	-	-	0.00	0.00	-			

PAN = 4.7%  
WASH LOSS WAS NOT TESTED.

SPECIFICATION: ASTM C 136    ASTM D 2216  
 TEST STANDARD: NONE  
 NOTES:                    MOISTURE - 6%  
 Test samples are retained for 30 days after submission and then discarded, unless other arrangements are made

# Dunn Geoscience Laboratory

5 Northway Lane North, Latham, NY 12110 (518) 783-8102

CLIENT: URS (VOLNEY)  
 LAB NUMBER: 86-3-103/553-3-4337 DATE RECEIVED: 3/11/86  
 TEST BY: JWH DATE TESTED: 3/12/86  
 REVIEWED BY: *[Signature]* DATE REPORTED: 4/7/86  
 SAMPLE DESCR: BW-17a S-3, 14.5' - 16'

## GRAIN SIZE DISTRIBUTION

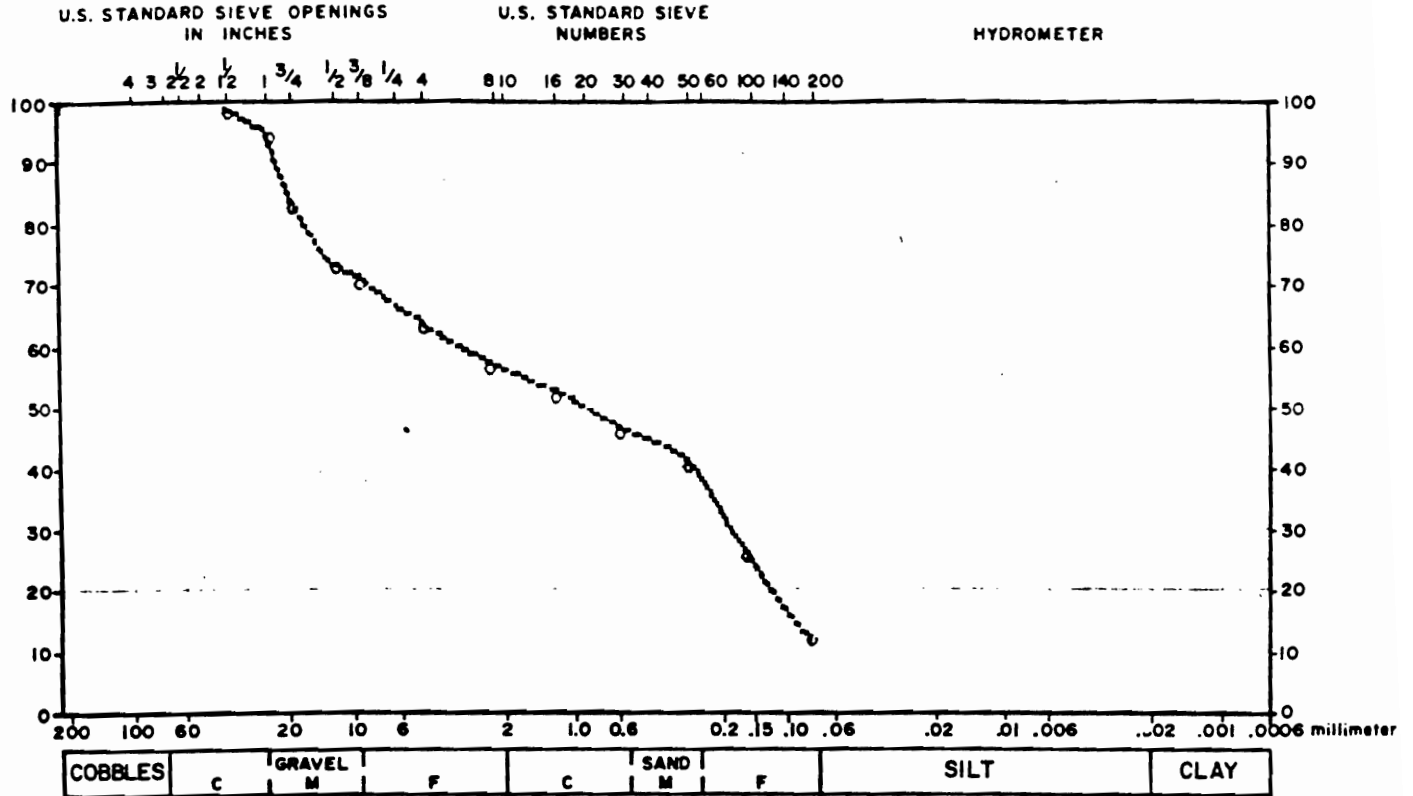

COARSE				FINE				HYDROMETER		
SIZE (Inches)	PERCENT RETAINED	CUMULATIVE PERCENT PASSING	SPECS.	SIEVE	PERCENT RETAINED	CUMULATIVE PERCENT PASSING	SPECS.	PARTICLE DIAMETER (mm)	PERCENT PASSING	SPECS.
1.5	0.00	100.00	-	4	7.48	64.52	-			
1	3.93	96.07	-	8	6.58	57.94	-			
3/4	11.44	84.62	-	16	4.77	53.18	-			
1/2	9.80	74.82	-	30	5.53	47.64	-			
3/8	2.82	72.00	-	50	5.37	42.27	-			
-	0.00	0.00	-	100	15.17	27.10	-			
-	0.00	0.00	-	200	14.66	12.44	-			
-	0.00	0.00	-	-	0.00	0.00	-			
-	0.00	0.00	-	-	0.00	0.00	-			
-	0.00	0.00	-	-	0.00	0.00	-			
-	0.00	0.00	-	-	0.00	0.00	-			
-	0.00	0.00	-	-	0.00	0.00	-			

PAN = 12.4%  
 WASH LOSS WAS NOT TESTED.

SPECIFICATION: ASTM C 136      ASTM D 2216  
 TEST STANDARD: NONE

NOTES:                      MOISTURE - 11.35%

Test samples are retained for 30 days after submission and then discarded, unless other arrangements are made.



**DUNN GEOSCIENCE LABORATORY**

5 NORTHWAY LANE NORTH  
LATHAM, NEW YORK 12110  
518-783-8102

**ATTEBERG LIMITS**

Type of Test	Liquid Limit Test					Plastic Limit Test				
Container No.										
No. of Blows										
Wt. Tare & Wet Sample										
Wt. Tare & Dry Sample										
Wt. Water										
Wt. Tare										
Wt. Dry Soil										
Moisture Content %										

**FLOW CURVE**

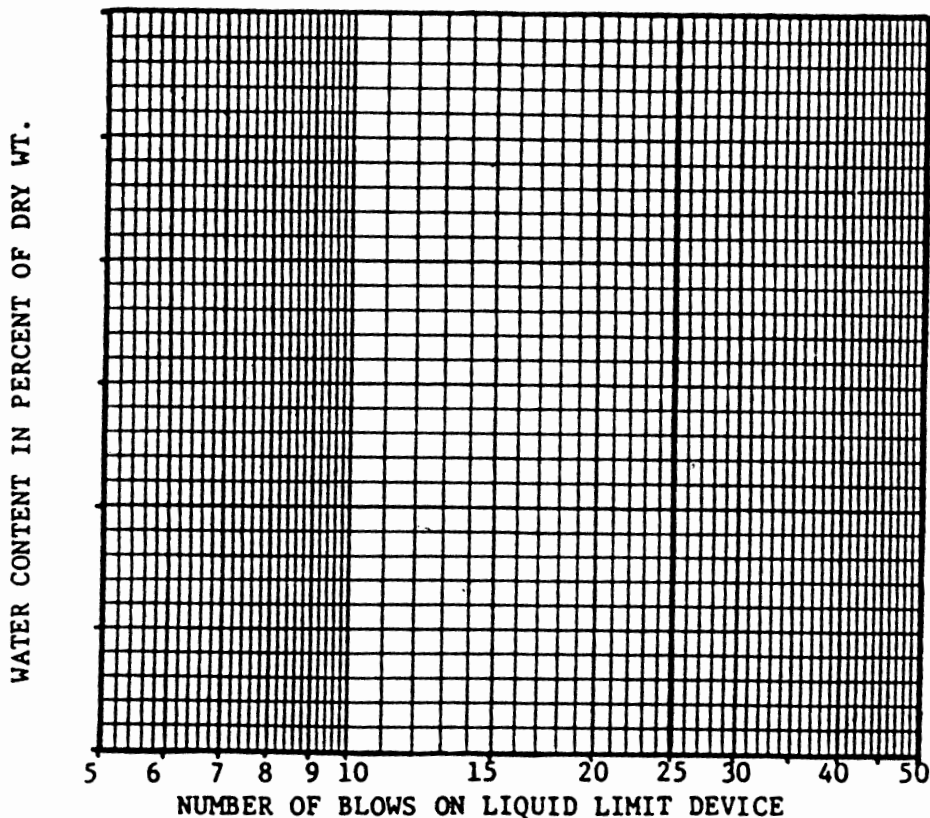

**RESULTS**

Liquid Limit \_\_\_\_\_ %  
 Plastic Limit \_\_\_\_\_ %  
 Plasticity Index \_\_\_\_\_ %

**REMARKS:**

Sampled tested and found to be non-plastic (NP)

Percent Moisture as recieved=24.28%

CLIENT URS Company, Inc	LAB NUMBER 86-3-112
LOCATION OF PROJECT BW-5 Volney Landfill	DATE RECEIVED 3/12/86
SAMPLE DESCRIPTION S-2 5.0'-7.0'	DATE TESTED 4/4/86
TEST BY TL	DATE REPORTED



**DUNN GEOSCIENCE LABORATORY**

8 NORTHWAY LANE NORTH  
LATHAM, NEW YORK 12110  
518-783-8102

**ATTEBERG LIMITS**

Type of Test	Liquid Limit Test					Plastic Limit Test				
Container No.										
No. of Blows										
Wt. Tare & Wet Sample										
Wt. Tare & Dry Sample										
Wt. Water										
Wt. Tare										
Wt. Dry Soil										
Moisture Content %										

**FLOW CURVE**

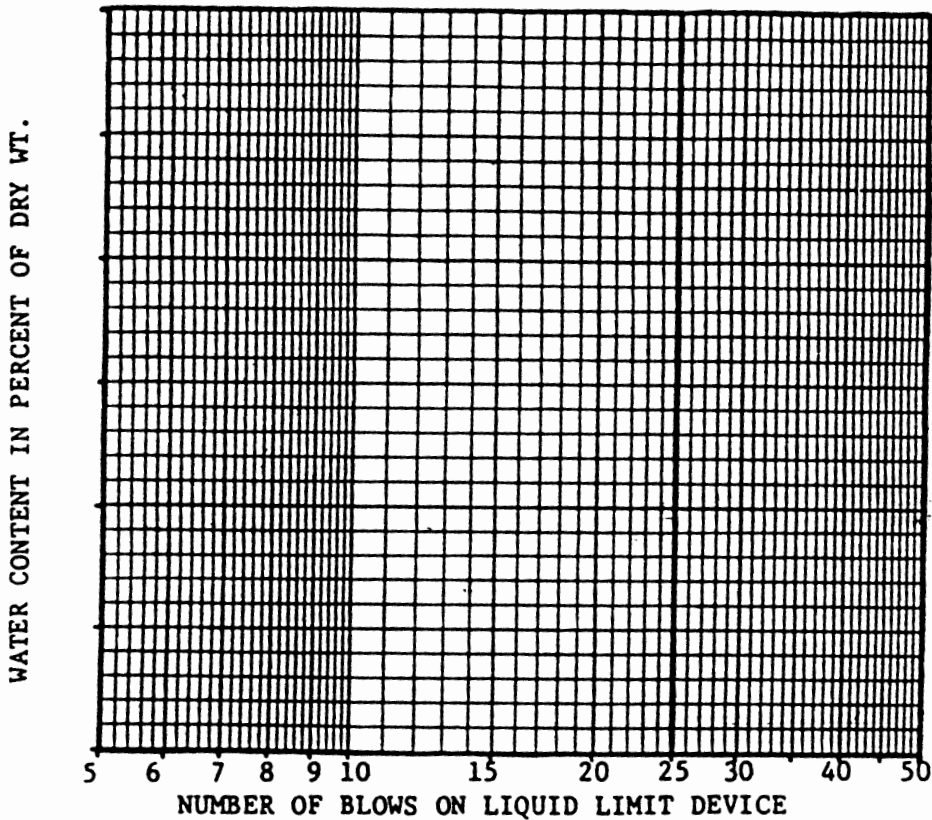

**RESULTS**  
 Liquid Limit \_\_\_\_\_ %  
 Plastic Limit \_\_\_\_\_ %  
 Plasticity Index \_\_\_\_\_ %

**REMARKS:**  
 Sample tested and found to be non-plastic (NP)  
 Percent moisture as received = 15.23%

CLIENT	URS Company, Inc.	LAB NUMBER	86-3-111
LOCATION OF PROJECT	BW-5 Volney Landfill	DATE RECEIVED	3/12/86
SAMPLE DESCRIPTION	S-3 10.0'-12.0'	DATE TESTED	4/4/86
TEST BY	TL	DATE RECEIVED	

APPENDIX F  
Hydraulic Conductivity Tests



## APPENDIX F

### HYDRAULIC CONDUCTIVITY TESTS

Hydraulic conductivity tests were performed on 23 wells to provide data useful in the interpretation of site hydrogeology. The tests conducted were slug tests in which a volume of water ("slug") was quickly introduced into the well. The recovery of the water level in the well toward the static groundwater level was measured with a pressure-sensitive transducer, suspended below the water surface. Recovery data was recorded with an Envirolab DL-240P strip chart data logger.

Data gathered from this test were interpreted using the method developed by Hvorslev (1951). This method is based on the assumption that recovery rates decline asymptotically with time after the initial instantaneous change in head. The recovery data, when normalized on a semi-log scale, should theoretically follow a straight line. After normalization, linear regression techniques were applied to the data and the best-fitting straight line was calculated. Hydraulic conductivity (K) of the formation immediately surrounding the screened portion of the well were found using this information as follows:

$$\text{Hydraulic Conductivity (K)} = \frac{r^2}{2} \frac{\ln(L/R)}{T_o L}$$

where:      r = radius of the well riser  
              R = radius of the well screen  
              L = saturated length of the well screen  
              T<sub>o</sub> = basic time lag

The basic time lag is determined from the best-fitting straight line of the recovery data as the time required to reduce the head difference to 37% of its original value.

The accuracy of the fit of the straight line can be assessed

using the R-squared (coefficient of determination) and residuals of the linear regression. Results were checked using a second method of analysis developed and modified after a technique used by the U.S. Department of the Navy and described in Cedergren (1977). This method uses six selected points from the recovery data and calculates the hydraulic conductivity values between these points. This method is more sensitive to measurement errors and was used as a check on the values determined by the Hvorslev (1951) technique.

The following data sheets provide test data, calculations and results for the Hvorslev (1951) technique and the second, data-checking technique (labeled DM-7).

Dunn Geoscience Corporation

Hvorslev (1951) Hydraulic Conductivity Program

Well Identification: B7-1 V

Well Parameters: Diameter = 2.00 inches  
 Screen Length = 3.46 feet

Test Type: Slug (1 gal)

Test Parameters: Baseline Depth/Pres. = 1.90  
 Initial Depth/Pres. = 64.10  
 Time Scale = 60.0000

Time	Depth/Pres.	lnr'	Regression	Residuals
180.00	17.70	-2.19722	-2.18390	-.01326
190.00	17.40	-2.25033	-2.24581	-.00452
200.00	17.10	-2.30642	-2.30766	.00124
210.00	16.80	-2.36535	-2.36951	.00366
220.00	16.50	-2.42903	-2.43136	.00233
230.00	16.20	-2.49647	-2.49321	-.00326
240.00	16.10	-2.52000	-2.55505	.03500
280.00	15.00	-2.82368	-2.80245	-.02123

B0 = -1.0707  
 B1 = -.3711  
 R-squared = .9931

Basic Time Lag = 11.429 seconds

Hydraulic Conductivity = 5.057E-03 cm/sec  
 1.434E+01 ft/day

## Dunn Geoscience Corporation

## Hvorslev (1951) Hydraulic Conductivity Program

Well Identification: BW-2 V

Well Parameters: Diameter = 2.00 inches  
Screen Length = 2.78 feet

Test Type: slug (2 gal)

Test Parameters: Baseline Depth/Pres. = 9.50  
Initial Depth/Pres. = 51.00  
Time Scale = 6.0000

Time	Depth/Pres.	LNf	Regression	Residuals
.00	51.00	.00000	-.40484	.40484
5.00	33.90	-.53111	-.52541	-.00570
10.00	30.60	-.67642	-.64598	-.03044
15.00	29.00	-.75528	-.76656	.01128
20.00	26.20	-.91028	-.88713	-.02315
25.00	23.90	-1.05847	-1.00770	-.05076
30.00	22.00	-1.19996	-1.12828	-.07169
35.00	20.70	-1.30978	-1.24885	-.06093
40.00	19.70	-1.40331	-1.36942	-.03388
45.00	18.50	-1.52847	-1.49000	-.03847
50.00	17.30	-1.67157	-1.61057	-.06100
55.00	15.90	-1.86940	-1.73115	-.13825
60.00	15.00	-2.02095	-1.85172	-.16923
65.00	14.80	-2.05799	-1.97229	-.08569
70.00	14.10	-2.19964	-2.09287	-.10677
75.00	13.90	-2.24409	-2.21344	-.03065
80.00	13.90	-2.24409	-2.33401	.08992
85.00	13.10	-2.44476	-2.45459	.00983
90.00	13.00	-2.47293	-2.57516	.10223
95.00	12.70	-2.56254	-2.69573	.13319
100.00	12.40	-2.66098	-2.81631	.15532

B0 = -.4048

B1 = -.1447

R-squared = .9729

Basic Time Lag = 246.805 seconds

Hydraulic Conductivity = 5.410E-04 cm/sec  
1.534E+00 ft/day

Dunn Geoscience Corporation

Hvorslev (1951) Hydraulic Conductivity Program

Well Identification: BW-3S V

Well Parameters: Diameter = 2.00 inches  
 Screen Length = 10.00 feet

Test Type: slug (1 gal)

Test Parameters: Baseline Depth/Pres. = 1.75  
 Initial Depth/Pres. = 91.00  
 Time Scale = 120.0000

Time	Depth/Pres.	LN <sup>2</sup>	Regression	Residuals
.00	91.00	.00000	-.26085	.26085
10.00	78.00	-.15742	-.56775	.41033
20.00	39.50	-.86046	-.87465	.01420
30.00	27.50	-1.24301	-1.18156	-.06145
40.00	19.70	-1.60385	-1.48846	-.11539
50.00	14.10	-1.97779	-1.79536	-.18242
60.00	10.70	-2.29979	-2.10226	-.19752
70.00	8.20	-2.62736	-2.40917	-.21820
80.00	6.50	-2.93330	-2.71607	-.21723
90.00	5.50	-3.16969	-3.02297	-.14672
100.00	4.50	-3.47984	-3.32987	-.14997
110.00	3.90	-3.72597	-3.63677	-.08920
120.00	3.80	-3.77360	-3.94368	.17008
130.00	3.30	-4.05319	-4.25058	.19739
140.00	2.80	-4.44265	-4.55748	.11483
150.00	2.60	-4.65396	-4.86438	.21042

B0 = -.2608  
 B1 = -3.6828  
 R-squared = .9317

Basic Time Lag = 12.042 seconds

Hydraulic Conductivity = 4.208E-03 cm/sec  
 1.193E+01 ft/day

Dunn Geoscience Corporation

Hvorslev (1951) Hydraulic Conductivity Program

Well Identification: B4-3J V

Well Parameters: Diameter = 2.00 inches  
 Screen length = 5.00 feet

Test Type: slug (1 gal)

Test Parameters: Baseline Depth/Pres. = .00  
 Initial Depth/Pres. = 76.00  
 Time Scale = 120.0000

Time	Depth/Pres.	LH	Regression	Residuals
10.00	41.00	-1.54684	-1.71265	.16614
20.00	28.00	-1.99883	-1.04997	.05144
30.00	18.30	-1.42383	-1.38725	-.03658
40.00	12.30	-1.82113	-1.72453	-.09600
50.00	8.80	-2.15598	-2.06181	-.09417
60.00	6.20	-2.50618	-2.39909	-.10709
70.00	4.50	-2.82666	-2.73637	-.09029
80.00	3.70	-3.02240	-3.07365	.05125
90.00	2.50	-3.41444	-3.41093	-.00351
100.00	2.10	-3.58880	-3.74821	.15942

B0 = -.3754  
 B1 = -4.0474  
 R-squared = .9397

Basic Time Lag = 9.259 seconds

Hydraulic Conductivity =  $9.3001E-03$  cm/sec  
 $2.653E+01$  ft/day

Dunn Geoscience Corporation

Hvorslev (1951) Hydraulic Conductivity Program

Well Identification: B4-3D V

Well Parameters: Diameter = 2.00 inches  
 Screen Length = 10.00 feet

Test Type: slug (1 gal)

Test Parameters: Baseline Depth/Pres. = .00  
 Initial Depth/Pres. = 91.90  
 Time Scale = 6.0000

Time	Depth/Pres.	LNf	Regression	Residuals
.00	91.90	.00000	.16813	-.16813
5.00	80.70	-.12996	-.02613	-.10383
10.00	69.00	-.28659	-.22039	-.06620
15.00	60.00	-.42636	-.41466	-.01170
20.00	50.30	-.60270	-.60892	.00622
25.00	42.80	-.76416	-.80318	.03902
30.00	36.00	-.93718	-.99744	.06026
35.00	29.90	-1.12284	-1.19170	.06886
40.00	24.10	-1.33849	-1.38597	.04748
45.00	20.20	-1.51502	-1.58023	.06521
50.00	14.80	-1.82607	-1.77449	-.05158
55.00	14.10	-1.87453	-1.96875	.09423
60.00	11.80	-2.05260	-2.16302	.11041
65.00	9.70	-2.24858	-2.35728	.10870
70.00	7.80	-2.46658	-2.55154	.08496
75.00	6.20	-2.69615	-2.74580	.04965
80.00	5.00	-2.91126	-2.94006	.02880
85.00	4.90	-2.93147	-3.13433	.20286
90.00	3.00	-3.42209	-3.32859	-.09350
95.00	2.10	-3.77876	-3.52285	-.25591
100.00	1.80	-3.93291	-3.71711	-.21580

B0 = .1681  
 B1 = -.2331  
 R-squared = .9909

Basic Time Lag = 300.658 seconds

Hydraulic Conductivity = 1.685E-04 cm/sec  
 4.777E-01 ft/day

Dunn Geoscience Corporation

Hvorslev (1951) Hydraulic Conductivity Program

Well Identification: BW-3br V

Well Parameters: Diameter = 4.00 inches  
 Screen Length = 6.50 feet

Test Type: slug (3 gal)

Test Parameters: Baseline Depth/Pres. = .00  
 Initial Depth/Pres. = 95.20  
 Time Scale = 6.0000

Time	Depth/Pres.	LNf	Regression	Residuals
.00	95.20	.00000	-.10898	.10898
10.00	83.90	-.12635	-.18881	.06245
20.00	74.90	-.23983	-.26864	.02881
30.00	67.30	-.34682	-.34847	.00165
40.00	61.50	-.43694	-.42830	-.00864
50.00	55.80	-.53421	-.50813	-.02608
60.00	51.20	-.62024	-.58796	-.03228
70.00	47.00	-.70583	-.66779	-.03804
80.00	43.30	-.78783	-.74762	-.04021
90.00	39.80	-.87211	-.82745	-.04466
100.00	36.70	-.95320	-.90728	-.04592
110.00	33.90	-1.03256	-.98711	-.04545
120.00	31.50	-1.10599	-1.06694	-.03905
130.00	29.20	-1.18181	-1.14677	-.03504
140.00	27.20	-1.25276	-1.22660	-.02616
150.00	25.80	-1.30561	-1.30643	.00083
160.00	23.90	-1.38210	-1.38626	.00416
170.00	22.10	-1.46040	-1.46609	.00569
180.00	20.90	-1.51623	-1.54592	.02969
190.00	19.80	-1.57030	-1.62575	.05546
200.00	18.20	-1.65456	-1.70558	.05103
210.00	16.50	-1.75262	-1.78542	.03280

B0 = -.1090  
 B1 = -.0479  
 R-squared = .9932

Basic Time Lag = 1116.145 seconds

Hydraulic Conductivity = 2.138E-04 cm/sec  
 6.060E-01 ft/day



Dunn Geoscience Corporation

Hvorslev (1951) Hydraulic Conductivity Program

Well Identification: BW-4S V

Well Parameters: Diameter = 2.00 inches  
 Screen Length = 4.48 feet

Test Type: slug (2 gal)

Test Parameters: Baseline Depth/Pres. = .00  
 Initial Depth/Pres. = 55.50  
 Time Scale = 6.0000

Time	Depth/Pres.	LNf	Regression	Residuals
120.00	38.30	-.37093	-.36766	-.00327
140.00	37.90	-.38143	-.38305	.00162
160.00	37.50	-.39204	-.39344	.00639
180.00	36.60	-.41633	-.41362	-.00251
200.00	36.10	-.43009	-.42921	-.00088
220.00	35.50	-.44685	-.44460	-.00225
240.00	35.10	-.45818	-.45999	.00180
260.00	34.40	-.47833	-.47537	-.00295
280.00	34.00	-.49002	-.49076	.00074
300.00	33.50	-.50484	-.50615	.00131

B0 = -.2753  
 B1 = -.0046  
 R-squared = .9959

Basic Time Lag = 9418.724 seconds

Hydraulic Conductivity = 9.994E-06 cm/sec  
 2.833E-02 ft/day

Dunn Geoscience Corporation  
 Hvorslev (1951) Hydraulic Conductivity Program

Well Identification: BW-4D V

Well Parameters: Diameter = 2.00 inches  
 Screen Length = 5.00 feet

Test Type: slug (1 gal)

Test Parameters: Baseline Depth/Pres. = .10  
 Initial Depth/Pres. = 99.20  
 Time Scale = 6.0000

Time	Depth/Pres.	LNf	Regression	Residuals
.00	99.20	.00000	-.00346	.00346
20.00	97.20	-.02039	-.02073	.00034
40.00	95.50	-.03805	-.03801	-.00004
60.00	93.90	-.05496	-.05528	.00032
80.00	92.00	-.07543	-.07256	-.00287
100.00	90.50	-.09189	-.08983	-.00205
120.00	88.90	-.10974	-.10711	-.00263
140.00	87.70	-.12335	-.12439	.00104
160.00	86.10	-.14178	-.14166	-.00012
180.00	84.40	-.16175	-.15894	-.00281
200.00	83.50	-.17248	-.17621	.00373
220.00	81.90	-.19185	-.19349	.00164

B0 = -.0035  
 B1 = -.0052  
 R-squared = .9987

Basic Time Lag = 11537.060 seconds

Hydraulic Conductivity = 7.512E-06 cm/sec  
 2.129E-02 ft/day

Dunn Geoscience Corporation

Hvorslev (1951) Hydraulic Conductivity Program

Well Identification: BW-5 V

Well Parameters: Diameter = 2.00 inches  
 Screen Length = 5.00 feet

Test Type: slug (1 gal)

Test Parameters: Baseline Depth/Pres. = .00  
 Initial Depth/Pres. = 55.00  
 Time Scale = 6.0000

Time	Depth/Pres.	LNf	Regression	Residuals
.00	55.00	.00000	-.10700	.10700
10.00	39.50	-.33103	-.35259	.02155
20.00	29.50	-.62294	-.59818	-.02477
30.00	22.50	-.89382	-.84377	-.05005
40.00	17.50	-1.14513	-1.08935	-.05578
50.00	13.50	-1.40464	-1.33494	-.06970
60.00	11.00	-1.60944	-1.58053	-.02891
70.00	9.00	-1.81011	-1.82612	.01601
80.00	7.00	-2.06142	-2.07171	.01029
90.00	5.50	-2.30258	-2.31730	.01472
100.00	4.50	-2.50326	-2.56289	.05963

B0 = -.1070  
 B1 = -.1474  
 R-squared = .9958

Basic Time Lag = 363.616 seconds

Hydraulic Conductivity = 2.383E-04 cm/sec  
 6.756E-01 ft/day

Dunn Geoscience Corporation

Hvorslev (1951) Hydraulic Conductivity Program

Well Identification: BW-6 V

Well Parameters: Diameter = 2.00 inches  
 Screen Length = 10.00 feet

Test Type: slug (1 gal)

Test Parameters: Baseline Depth/Pres. = .00  
 Initial Depth/Pres. = 97.50  
 Time Scale = 120.0000

Time	Depth/Pres.	LNf	Regression	Residuals
.00	97.50	.00000	.03482	-.03482
50.00	77.00	-.23605	-.19937	-.03667
100.00	62.00	-.45272	-.43357	-.01915
150.00	50.00	-.66783	-.66776	-.00007
200.00	40.50	-.87855	-.90195	.02340
250.00	32.50	-1.09861	-1.13614	.03753
300.00	26.00	-1.32176	-1.37033	.04858
350.00	20.50	-1.55943	-1.60452	.04510
400.00	16.00	-1.80726	-1.83871	.03145
450.00	12.50	-2.05412	-2.07291	.01878
500.00	9.50	-2.32856	-2.30710	-.02146
550.00	7.00	-2.63394	-2.54129	-.09265

B0 = .0348  
 B1 = -.5621  
 R-squared = .9975

Basic Time Lag = 110.467 seconds

Hydraulic Conductivity = 4.587E-04 cm/sec  
 1.300E+00 ft/day

Dunn Geoscience Corporation

Hvorslev (1951) Hydraulic Conductivity Program

Well Identification: BW-7S V

Well Parameters: Diameter = 2.00 inches  
 Screen Length = 10.00 feet

Test Type: slug (1gal)

Test Parameters: Baseline Depth/Pres. = 3.30  
 Initial Depth/Pres. = 95.75  
 Time Scale = 30.0000

Time	Depth/Pres.	LNf	Regression	Residuals
.00	95.75	.00000	-.10124	.10124
50.00	81.80	-.16357	-.17041	.00684
100.00	75.80	-.24308	-.23959	-.00349
150.00	70.10	-.32496	-.30877	-.01620
200.00	65.50	-.39631	-.37794	-.01837
260.00	60.30	-.48362	-.46095	-.02266
300.00	57.30	-.53768	-.51629	-.02139
360.00	53.00	-.62066	-.59930	-.02136
400.00	50.40	-.67439	-.65464	-.01975
460.00	46.60	-.75852	-.73765	-.02086
500.00	44.50	-.80823	-.79300	-.01523
600.00	39.50	-.93761	-.93135	-.00626
700.00	35.00	-1.07035	-1.06970	-.00065
800.00	31.30	-1.19446	-1.20805	.01359
1000.00	25.20	-1.44018	-1.48475	.04457

B0 = -.1012  
 B1 = -.0415  
 R-squared = .9931

Basic Time Lag = 1299.245 seconds

Hydraulic Conductivity = 3.900E-05 cm/sec  
 1.105E-01 ft/day

Dunn Geoscience Corporation

Hvorslev (1951) Hydraulic Conductivity Program

Well Identification: BW-7D V

Well Parameters: Diameter = 2.00 inches  
 Screen Length = 10.00 feet

Test Type: slug (1gal)

Test Parameters: Baseline Depth/Pres. = 9.00  
 Initial Depth/Pres. = 50.30  
 Time Scale = 6.0000

Time	Depth/Pres.	LNF	Regression	Residuals
.00	50.30	.00000	-.02774	.02774
10.00	37.00	-.38866	-.35716	-.03150
20.00	29.10	-.72014	-.68658	-.03356
30.00	23.30	-1.06060	-1.01601	-.04460
40.00	19.70	-1.35062	-1.34543	-.00519
50.00	17.00	-1.64142	-1.67485	.03343
60.00	14.80	-1.96300	-2.00428	.04127
70.00	13.20	-2.28578	-2.33370	.04792
80.00	12.00	-2.62225	-2.66312	.04087
90.00	11.20	-2.93241	-2.99254	.06014
100.00	10.30	-3.45850	-3.32197	-.13653

B0 = -.0277  
 B1 = -.1977  
 R-squared = .9972

Basic Time Lag = 295.141 seconds

Hydraulic Conductivity = 1.717E-04 cm/sec  
 4.866E-01 ft/day

Dunn Geoscience Corporation

Hvorslev (1951) Hydraulic Conductivity Program

Well Identification: BW-8S V

Well Parameters: Diameter = 2.00 inches  
 Screen Length = 9.12 feet

Test Type: slug (1 gal)

Test Parameters: Baseline Depth/Pres. = .00  
 Initial Depth/Pres. = 17.00  
 Time Scale = 12.0000

Time	Depth/Pres.	LNf	Regression	Residuals
.00	17.00	.00000	-.08769	.08769
10.00	12.20	-.33178	-.31446	-.01732
20.00	9.50	-.58192	-.54123	-.04069
30.00	7.50	-.81831	-.76800	-.05031
40.00	6.00	-1.04145	-.99477	-.04668
50.00	5.00	-1.22378	-1.22155	-.00223
60.00	4.00	-1.44692	-1.44832	.00140
70.00	3.50	-1.58045	-1.67509	.09464
80.00	2.50	-1.91692	-1.90186	-.01506
90.00	2.00	-2.14007	-2.12863	-.01143

B0 = -.0877  
 B1 = -.2721  
 R-squared = .9945

Basic Time Lag = 201.152 seconds

Hydraulic Conductivity = 2.709E-04 cm/sec  
 7.678E-01 ft/day

Dunn Geoscience Corporation

Hvorslev (1951) Hydraulic Conductivity Program

Well Identification: BW-8D V

Well Parameters: Diameter = 2.00 inches  
 Screen Length = 10.00 feet

Test Type: slug (1 gal)

Test Parameters: Baseline Depth/Pres. = 10.00  
 Initial Depth/Pres. = 93.00  
 Time Scale = 60.0000

Time	Depth/Pres.	LNf	Regression	Residuals
80.00	19.30	-2.18883	-2.34304	.15421
100.00	16.20	-2.59429	-2.55197	-.04232
120.00	14.80	-2.85022	-2.76091	-.08931
140.00	13.90	-3.05786	-2.96984	-.08802
160.00	13.50	-3.16608	-3.17878	.01270
180.00	12.70	-3.42559	-3.38771	-.03787
200.00	12.30	-3.58593	-3.59665	.01072
220.00	12.00	-3.72569	-3.80559	.07989

B0 = -1.5073  
 B1 = -.6268  
 R-squared = .9738

Basic Time Lag = 48.560 seconds

Hydraulic Conductivity = 1.043E-03 cm/sec  
 2.958E+00 ft/day



Dunn Geoscience Corporation

Hvorslev (1951) Hydraulic Conductivity Program

Well Identification: BW-8br V

Well Parameters: Diameter = 4.00 inches  
 Screen Length = 5.00 feet

Test Type: slug (3 gal)

Test Parameters: Baseline Depth/Pres. = 10.00  
 Initial Depth/Pres. = 93.70  
 Time Scale = 6.0000

Time	Depth/Pres.	LNF	Regression	Residuals
.00	93.70	.00000	-.01651	.01651
40.00	72.20	-.29683	-.29625	-.00063
80.00	56.70	-.58349	-.57599	-.00750
120.00	45.50	-.85771	-.85573	-.00198
160.00	36.50	-1.15009	-1.13547	-.01463
200.00	30.10	-1.42652	-1.41520	-.01131
240.00	25.40	-1.69287	-1.69494	.00207
280.00	21.80	-1.95914	-1.97468	.01554
320.00	18.80	-2.25249	-2.25442	.00193

B0 = -.0165  
 B1 = -.0420  
 R-squared = .9998

Basic Time Lag = 1406.296 seconds

Hydraulic Conductivity = 2.048E-04 cm/sec  
 5.805E-01 ft/day

Dunn Geoscience Corporation

Hvorslev (1951) Hydraulic Conductivity Program

Well Identification: BW-10D V

Well Parameters: Diameter = 2.00 inches  
 Screen Length = 5.00 feet

Test Type: slug (1gal)

Test Parameters: Baseline Depth/Pres. = 10.00  
 Initial Depth/Pres. = 57.50  
 Time Scale = 6.0000

Time	Depth/Pres.	LNf	Regression	Residuals
.00	57.50	.00000	-.04587	.04587
20.00	51.80	-.12783	-.14184	.01401
40.00	47.20	-.24442	-.23781	-.00661
60.00	43.50	-.34918	-.33378	-.01541
80.00	40.00	-.45953	-.42974	-.02979
100.00	37.50	-.54654	-.52571	-.02083
120.00	35.00	-.64185	-.62168	-.02017
140.00	33.00	-.72524	-.71765	-.00759
160.00	31.00	-.81621	-.81362	-.00259
180.00	29.00	-.91629	-.90958	-.00671
200.00	27.80	-.98153	-1.00555	.02402
220.00	26.20	-1.07572	-1.10152	.02580

B0 = -.0459  
 B1 = -.0288  
 R-squared = .9957

Basic Time Lag = 1988.431 seconds

Hydraulic Conductivity = 4.358E-05 cm/sec  
 1.235E-01 ft/day

Dunn Geoscience Corporation

Hvorslev (1951) Hydraulic Conductivity Program

Well Identification: BW-11 V

Well Parameters: Diameter = 2.00 inches  
Screen Length = 5.50 feet

Test Type: slug (2 gal)

Test Parameters: Baseline Depth/Pres. = 10.00  
Initial Depth/Pres. = 20.80  
Time Scale = 60.0000

Time	Depth/Pres.	LNf	Regression	Residuals
.00	20.80	.00000	-.23772	.23772
5.00	14.90	-.79031	-.58282	-.20749
10.00	13.70	-1.07121	-.92792	-.14329
15.00	12.90	-1.31484	-1.27303	-.04181
20.00	12.50	-1.46326	-1.61813	.15487

B0 = -.2377  
B1 = -4.1412  
R-squared = .8909

Basic Time Lag = 11.044 seconds

Hydraulic Conductivity = 7.300E-03 cm/sec  
2.069E+01 ft/day

Dunn Geoscience Corporation

Hvorslev (1951) Hydraulic Conductivity Program

Well Identification: Bw-12 V

Well Parameters: Diameter = 2.00 inches  
 Screen Length = 2.66 feet

Test Type: slug (2 gal)

Test Parameters: Baseline Depth/Pres. = 10.00  
 Initial Depth/Pres. = 31.50  
 Time Scale = 6.0000

Time	Depth/Pres.	LNF	Regression	Residuals
30.00	20.10	-.75552	-.84423	.08872
40.00	18.10	-.97619	-.96388	-.01231
50.00	17.10	-1.10796	-1.08352	-.02444
60.00	16.10	-1.25976	-1.20316	-.05660
70.00	15.70	-1.32759	-1.32280	-.00478
80.00	14.80	-1.49944	-1.44245	-.05699
90.00	14.50	-1.56398	-1.56209	-.00189
100.00	14.00	-1.68176	-1.68173	-.00003
110.00	13.80	-1.73305	-1.80137	.06832

B0 = -.4853  
 B1 = -.0718  
 R-squared = .9775

Basic Time Lag = 430.192 seconds

Hydraulic Conductivity = 3.203E-04 cm/sec  
 9.079E-01 ft/day

Dunn Geoscience Corporation

Hvorslev (1951) Hydraulic Conductivity Program

Well Identification: BW-13 V

Well Parameters: Diameter = 2.00 inches  
 Screen Length = 5.00 feet

Test Type: slug (1 gal)

Test Parameters: Baseline Depth/Pres. = 11.90  
 Initial Depth/Pres. = 72.10  
 Time Scale = 12.0000

Time	Depth/Pres.	INF	Regression	Residuals
40.00	59.50	-.23484	-.27882	.04398
60.00	55.70	-.31804	-.35277	.03473
80.00	52.00	-.40630	-.42672	.02042
100.00	47.70	-.51972	-.50067	-.01906
120.00	44.90	-.60116	-.57462	-.02655
140.00	42.30	-.68323	-.64857	-.03466
160.00	40.10	-.75835	-.72251	-.03584
180.00	38.30	-.82431	-.79646	-.02784
200.00	36.60	-.89087	-.87041	-.02046
220.00	35.10	-.95352	-.94436	-.00916
240.00	33.80	-1.01119	-1.01831	.00713
260.00	32.10	-1.09199	-1.09226	.00027
280.00	31.20	-1.13757	-1.16621	.02864
300.00	30.00	-1.20176	-1.24016	.03840

B0 = -.1309  
 B1 = -.0444  
 R-squared = .9914

Basic Time Lag = 1175.238 seconds

Hydraulic Conductivity = 7.374E-05 cm/sec  
 2.090E-01 ft/day

Dunn Geoscience Corporation

Hvorslev (1951) Hydraulic Conductivity Program

Well Identification: BW-14 V

Well Parameters: Diameter = 2.00 inches  
 Screen Length = 10.00 feet

Test Type: slug (1 gal)

Test Parameters: Baseline Depth/Pres. = .00  
 Initial Depth/Pres. = 81.10  
 Time Scale = 30.0000

Time	Depth/Pres.	LNf	Regression	Residuals
.00	81.10	.00000	-.01383	.01383
20.00	61.50	-.27665	-.24988	-.02676
40.00	48.10	-.52240	-.48593	-.03647
60.00	38.70	-.73984	-.72198	-.01787
80.00	31.40	-.94888	-.95803	.00915
100.00	25.50	-1.15700	-1.19407	.03707
120.00	20.10	-1.39496	-1.43012	.03516
140.00	15.80	-1.63567	-1.66617	.03050
160.00	12.30	-1.88608	-1.90222	.01614
180.00	9.70	-2.12356	-2.13827	.01471
200.00	7.00	-2.44977	-2.37432	-.07546

B0 = -.0138  
 B1 = -.3541  
 R-squared = .9980

Basic Time Lag = 167.113 seconds

Hydraulic Conductivity = 3.032E-04 cm/sec  
 8.594E-01 ft/day

Dunn Geoscience Corporation

Hvorslev (1951) Hydraulic Conductivity Program

Well Identification: BW-15 V

Well Parameters: Diameter = 2.00 inches  
 Screen Length = 10.00 feet

Test Type: slug (1 gal)

Test Parameters: Baseline Depth/Pres. = 10.00  
 Initial Depth/Pres. = 86.00  
 Time Scale = 60.0000

Time	Depth/Pres.	LNf	Regression	Residuals
40.00	34.50	-1.13206	-1.33394	.20187
60.00	26.50	-1.52737	-1.59037	.06299
80.00	21.90	-1.85419	-1.84680	-.00740
100.00	18.50	-2.19067	-2.10323	-.08744
120.00	16.30	-2.49018	-2.35966	-.13053
140.00	15.00	-2.72130	-2.61609	-.10521
160.00	13.90	-2.96976	-2.87252	-.09724
180.00	13.10	-3.19933	-3.12895	-.07038
200.00	12.50	-3.41444	-3.38538	-.02906
220.00	12.10	-3.58880	-3.64181	.05302
240.00	11.90	-3.68888	-3.89824	.20936

B0 = -.8211  
 B1 = -.7693  
 R-squared = .9807

Basic Time Lag = 13.955 seconds

Hydraulic Conductivity = 3.631E-03 cm/sec  
 1.029E+01 ft/day

Dunn Geoscience Corporation

Hvorslev (1951) Hydraulic Conductivity Program

Well Identification: BW-16 V

Well Parameters: Diameter = 2.00 inches  
 Screen Length = 5.00 feet

Test Type: slug (1 gal)

Test Parameters: Baseline Depth/Pres. = 9.90  
 Initial Depth/Pres. = 69.90  
 Time Scale = 30.0000

Time	Depth/Pres.	LNf	Regression	Residuals
.00	69.90	.00000	-.02086	.02086
40.00	40.20	-.68320	-.58707	-.09613
80.00	28.10	-1.19292	-1.15327	-.03965
120.00	21.00	-1.68740	-1.71948	.03208
160.00	16.50	-2.20727	-2.28568	.07841
200.00	13.90	-2.70805	-2.85189	.14384
240.00	11.90	-3.40120	-3.41809	.01689
270.00	11.00	-3.99903	-3.84274	-.15629

B0 = -.0209  
 B1 = -.4247  
 R-squared = .9951

Basic Time Lag = 138.344 seconds

Hydraulic Conductivity = 6.264E-04 cm/sec  
 1.776E+00 ft/day



Dunn Geoscience Corporation

Hvorslev (1951) Hydraulic Conductivity Program

Well Identification: BW-17 V

Well Parameters: Diameter = 2.00 inches  
Screen Length = 5.00 feet

Test Type: slug (1 gal)

Test Parameters: Baseline Depth/Pres. = 10.40  
Initial Depth/Pres. = 58.70  
Time Scale = 6.0000

Time	Depth/Pres.	LNf	Regression	Residuals
.00	58.00	-.01460	-.04263	.02803
40.00	49.50	-.21131	-.19914	-.01216
80.00	43.80	-.36888	-.35566	-.01322
120.00	39.10	-.52053	-.51217	-.00836
160.00	35.00	-.67469	-.66869	-.00600
200.00	31.50	-.82816	-.82520	-.00295
240.00	28.50	-.98152	-.98172	.00020
280.00	26.10	-1.12377	-1.13823	.01446

B0 = -.0426  
B1 = -.0235  
R-squared = .9986

Basic Time Lag = 2446.720 seconds

Hydraulic Conductivity = 3.542E-05 cm/sec  
1.004E-01 ft/day

Dunn Geoscience Corporation

Hvorslev (1951) Hydraulic Conductivity Program

Well Identification: BW-17a V

Well Parameters: Diameter = 2.00 inches  
 Screen Length = 10.00 feet

Test Type: slug (1 gal)

Test Parameters: Baseline Depth/Pres. = 2.00  
 Initial Depth/Pres. = 83.00  
 Time Scale = 12.0000

Time	Depth/Pres.	LN'	Regression	Residuals
15.00	43.00	-.68088	-.52300	-.15787
20.00	36.50	-.85349	-.78170	-.07179
25.00	28.50	-1.11730	-1.04039	-.07691
30.00	24.20	-1.29436	-1.29909	.00473
35.00	20.00	-1.50408	-1.55779	.05371
40.00	16.20	-1.74121	-1.81648	.07528
45.00	13.50	-1.95210	-2.07518	.12308
50.00	11.00	-2.19722	-2.33387	.13665
55.00	9.00	-2.44854	-2.59257	.14403
60.00	7.30	-2.72674	-2.85127	.12452
65.00	5.90	-3.03347	-3.10996	.07649
70.00	4.60	-3.43894	-3.36866	-.07028
75.00	3.50	-3.98898	-3.62735	-.36163

B0 = .2531  
 B1 = -.6209  
 R-squared = .9794

Basic Time Lag = 121.096 seconds

Hydraulic Conductivity = 4.184E-04 cm/sec  
 1.186E+00 ft/day

Dunn Geoscience Corporation

DM-7 (1971) Hydraulic Conductivity Program

Well Identification: B-1 V

Well Parameters: Diameter = 2.00 inches  
Screen Length = 8.46 feet

Test Type: Slug (1 gal)

Test Parameters: Baseline Depth/Pres. = 11.90  
Initial Depth/Pres. = 64.10  
Time Scale = 60.0000

Time	Depth/Pres.
200.00	17.10
220.00	16.50
240.00	16.10
260.00	15.70
280.00	15.00
300.00	14.40

Hydraulic Conductivity Results

K(1,2) = 3.543E-04 cm/sec = 1.004E+00 ft/day  
K(1,3) = 3.086E-04 cm/sec = 8.748E-01 ft/day  
K(1,4) = 3.022E-04 cm/sec = 8.565E-01 ft/day  
K(1,5) = 3.737E-04 cm/sec = 1.059E+00 ft/day  
K(1,6) = 4.233E-04 cm/sec = 1.200E+00 ft/day  
K(2,3) = 2.629E-04 cm/sec = 7.452E-01 ft/day  
K(2,4) = 2.761E-04 cm/sec = 7.826E-01 ft/day  
K(2,5) = 3.802E-04 cm/sec = 1.078E+00 ft/day  
K(2,6) = 4.405E-04 cm/sec = 1.249E+00 ft/day  
K(3,4) = 2.892E-04 cm/sec = 8.199E-01 ft/day  
K(3,5) = 4.388E-04 cm/sec = 1.244E+00 ft/day  
K(3,6) = 4.998E-04 cm/sec = 1.417E+00 ft/day  
K(4,5) = 5.884E-04 cm/sec = 1.668E+00 ft/day  
K(4,6) = 6.050E-04 cm/sec = 1.715E+00 ft/day  
K(5,6) = 6.217E-04 cm/sec = 1.762E+00 ft/day

Average Hydraulic Conductivity = 4.110E-04 cm/sec  
1.165E+00 ft/day

Dunn Geoscience Corporation

DM-7 (1971) Hydraulic Conductivity Program

Well Identification: BW-2 V

Well Parameters: Diameter = 2.00 inches  
Screen Length = 2.78 feet

Test Type: slug (2 gal)

Test Parameters: Baseline Depth/Pres. = 9.50  
Initial Depth/Pres. = 51.00  
Time Scale = 6.0000

Time	Depth/Pres.
.00	51.00
20.00	28.20
40.00	19.70
60.00	15.00
80.00	13.90
100.00	12.40

Hydraulic Conductivity Results

K(1,2) = 6.077E-04 cm/sec = 1.723E+00 ft/day  
K(1,3) = 4.684E-04 cm/sec = 1.328E+00 ft/day  
K(1,4) = 4.497E-04 cm/sec = 1.275E+00 ft/day  
K(1,5) = 3.745E-04 cm/sec = 1.062E+00 ft/day  
K(1,6) = 3.553E-04 cm/sec = 1.007E+00 ft/day  
K(2,3) = 3.291E-04 cm/sec = 9.330E-01 ft/day  
K(2,4) = 3.707E-04 cm/sec = 1.051E+00 ft/day  
K(2,5) = 2.968E-04 cm/sec = 8.414E-01 ft/day  
K(2,6) = 2.922E-04 cm/sec = 8.283E-01 ft/day  
K(3,4) = 4.123E-04 cm/sec = 1.169E+00 ft/day  
K(3,5) = 2.807E-04 cm/sec = 7.956E-01 ft/day  
K(3,6) = 2.799E-04 cm/sec = 7.934E-01 ft/day  
K(4,5) = 1.490E-04 cm/sec = 4.223E-01 ft/day  
K(4,6) = 2.137E-04 cm/sec = 6.056E-01 ft/day  
K(5,6) = 2.783E-04 cm/sec = 7.890E-01 ft/day

Average Hydraulic Conductivity = 3.439E-04 cm/sec  
9.748E-01 ft/day

Dunn Geoscience Corporation

DM-7 (1971) Hydraulic Conductivity Program

Well Identification: BW-3S V

Well Parameters: Diameter = 2.00 inches  
Screen Length = 10.00 feet

Test Type: slug (1 gal)

Test Parameters: Baseline Depth/Pres. = 1.75  
Initial Depth/Pres. = 91.00  
Time Scale = 120.0000

Time	Depth/Pres.
.00	91.00
40.00	19.70
80.00	6.50
120.00	3.80
160.00	2.50
200.00	2.20

Hydraulic Conductivity Results

K(1,2) = 4.063E-03 cm/sec = 1.152E+01 ft/day  
K(1,3) = 3.716E-03 cm/sec = 1.053E+01 ft/day  
K(1,4) = 3.187E-03 cm/sec = 9.033E+00 ft/day  
K(1,5) = 3.027E-03 cm/sec = 8.580E+00 ft/day  
K(1,6) = 2.680E-03 cm/sec = 7.598E+00 ft/day  
K(2,3) = 3.368E-03 cm/sec = 9.547E+00 ft/day  
K(2,4) = 2.748E-03 cm/sec = 7.791E+00 ft/day  
K(2,5) = 2.681E-03 cm/sec = 7.601E+00 ft/day  
K(2,6) = 2.335E-03 cm/sec = 6.618E+00 ft/day  
K(3,4) = 2.129E-03 cm/sec = 6.034E+00 ft/day  
K(3,5) = 2.338E-03 cm/sec = 6.628E+00 ft/day  
K(3,6) = 1.990E-03 cm/sec = 5.641E+00 ft/day  
K(4,5) = 2.547E-03 cm/sec = 7.221E+00 ft/day  
K(4,6) = 1.921E-03 cm/sec = 5.445E+00 ft/day  
K(5,6) = 1.294E-03 cm/sec = 3.668E+00 ft/day

Average Hydraulic Conductivity = 2.668E-03 cm/sec  
7.564E+00 ft/day

Dunn Geoscience Corporation

DM-7 (1971) Hydraulic Conductivity Program

Well Identification: BW-3I V

Well Parameters: Diameter = 2.00 inches  
 Screen Length = 5.00 feet

Test Type: slug (1 gal)

Test Parameters: Baseline Depth/Pres. = .00  
 Initial Depth/Pres. = 76.00  
 Time Scale = 120.0000

Time	Depth/Pres.
.00	76.00
40.00	12.30
80.00	3.70
120.00	1.80
160.00	1.00
200.00	.60

Hydraulic Conductivity Results

K(1,2) = 7.891E-03 cm/sec = 2.237E+01 ft/day  
 K(1,3) = 6.548E-03 cm/sec = 1.856E+01 ft/day  
 K(1,4) = 5.406E-03 cm/sec = 1.532E+01 ft/day  
 K(1,5) = 4.691E-03 cm/sec = 1.330E+01 ft/day  
 K(1,6) = 4.196E-03 cm/sec = 1.189E+01 ft/day  
 K(2,3) = 5.205E-03 cm/sec = 1.476E+01 ft/day  
 K(2,4) = 4.164E-03 cm/sec = 1.180E+01 ft/day  
 K(2,5) = 3.625E-03 cm/sec = 1.028E+01 ft/day  
 K(2,6) = 3.272E-03 cm/sec = 9.275E+00 ft/day  
 K(3,4) = 3.122E-03 cm/sec = 8.850E+00 ft/day  
 K(3,5) = 2.835E-03 cm/sec = 8.035E+00 ft/day  
 K(3,6) = 2.628E-03 cm/sec = 7.448E+00 ft/day  
 K(4,5) = 2.547E-03 cm/sec = 7.220E+00 ft/day  
 K(4,6) = 2.380E-03 cm/sec = 6.747E+00 ft/day  
 K(5,6) = 2.214E-03 cm/sec = 6.274E+00 ft/day

Average Hydraulic Conductivity = 4.048E-03 cm/sec  
 1.148E+01 ft/day

Dunn Geoscience Corporation

DM-7 (1971) Hydraulic Conductivity Program

Well Identification: BW-3D V

Well Parameters: Diameter = 2.00 inches  
 Screen Length = 10.00 feet

Test Type: slug (1 gal)

Test Parameters: Baseline Depth/Pres. = .00  
 Initial Depth/Pres. = 91.90  
 Time Scale = 6.0000

Time	Depth/Pres.
.00	91.90
20.00	50.30
40.00	24.10
60.00	11.80
80.00	5.00
100.00	1.80

Hydraulic Conductivity Results

K(1,2) = 1.527E-04 cm/sec = 4.328E-01 ft/day  
 K(1,3) = 1.695E-04 cm/sec = 4.806E-01 ft/day  
 K(1,4) = 1.733E-04 cm/sec = 4.913E-01 ft/day  
 K(1,5) = 1.844E-04 cm/sec = 5.227E-01 ft/day  
 K(1,6) = 1.993E-04 cm/sec = 5.649E-01 ft/day  
 K(2,3) = 1.864E-04 cm/sec = 5.284E-01 ft/day  
 K(2,4) = 1.837E-04 cm/sec = 5.206E-01 ft/day  
 K(2,5) = 1.949E-04 cm/sec = 5.526E-01 ft/day  
 K(2,6) = 2.109E-04 cm/sec = 5.979E-01 ft/day  
 K(3,4) = 1.809E-04 cm/sec = 5.128E-01 ft/day  
 K(3,5) = 1.992E-04 cm/sec = 5.647E-01 ft/day  
 K(3,6) = 2.191E-04 cm/sec = 6.210E-01 ft/day  
 K(4,5) = 2.175E-04 cm/sec = 6.166E-01 ft/day  
 K(4,6) = 2.382E-04 cm/sec = 6.751E-01 ft/day  
 K(5,6) = 2.588E-04 cm/sec = 7.337E-01 ft/day

Average Hydraulic Conductivity = 1.979E-04 cm/sec  
 5.611E-01 ft/day

Dunn Geoscience Corporation

DM-7 (1971) Hydraulic Conductivity Program

Well Identification: B7-3br V

Well Parameters: Diameter = 4.00 inches  
Screen Length = 6.50 feet

Test Type: slug (3 gal)

Test Parameters: Baseline Depth/Pres. = .00  
Initial Depth/Pres. = 95.20  
Time Scale = 6.0000

Time	Depth/Pres.
.00	95.20
40.00	61.50
80.00	43.30
120.00	31.50
160.00	23.90
200.00	18.20

Hydraulic Conductivity Results

K(1,2) = 2.606E-04 cm/sec = 7.388E-01 ft/day  
K(1,3) = 2.350E-04 cm/sec = 6.661E-01 ft/day  
K(1,4) = 2.199E-04 cm/sec = 6.234E-01 ft/day  
K(1,5) = 2.061E-04 cm/sec = 5.842E-01 ft/day  
K(1,6) = 1.974E-04 cm/sec = 5.595E-01 ft/day  
K(2,3) = 2.093E-04 cm/sec = 5.933E-01 ft/day  
K(2,4) = 1.995E-04 cm/sec = 5.656E-01 ft/day  
K(2,5) = 1.879E-04 cm/sec = 5.327E-01 ft/day  
K(2,6) = 1.816E-04 cm/sec = 5.147E-01 ft/day  
K(3,4) = 1.898E-04 cm/sec = 5.380E-01 ft/day  
K(3,5) = 1.772E-04 cm/sec = 5.024E-01 ft/day  
K(3,6) = 1.723E-04 cm/sec = 4.885E-01 ft/day  
K(4,5) = 1.647E-04 cm/sec = 4.669E-01 ft/day  
K(4,6) = 1.636E-04 cm/sec = 4.638E-01 ft/day  
K(5,6) = 1.625E-04 cm/sec = 4.607E-01 ft/day

Average Hydraulic Conductivity = 1.952E-04 cm/sec  
5.532E-01 ft/day



Dunn Geoscience Corporation

DM-7 (1971) Hydraulic Conductivity Program

Well Identification: B7-4S V

Well Parameters: Diameter = 2.00 inches  
Screen Length = 4.48 feet

Test Type: slug (2 gal)

Test Parameters: Baseline Depth/Pres. = .00  
Initial Depth/Pres. = 55.50  
Time Scale = 6.0000

Time	Depth/Pres.
.00	55.50
60.00	41.90
120.00	38.30
180.00	36.60
240.00	35.10
300.00	33.50

Hydraulic Conductivity Results

K(1,2) = 4.410E-05 cm/sec = 1.250E-01 ft/day  
K(1,3) = 2.910E-05 cm/sec = 8.248E-02 ft/day  
K(1,4) = 2.177E-05 cm/sec = 6.171E-02 ft/day  
K(1,5) = 1.797E-05 cm/sec = 5.094E-02 ft/day  
K(1,6) = 1.584E-05 cm/sec = 4.490E-02 ft/day  
K(2,3) = 1.409E-05 cm/sec = 3.995E-02 ft/day  
K(2,4) = 1.061E-05 cm/sec = 3.007E-02 ft/day  
K(2,5) = 9.260E-06 cm/sec = 2.625E-02 ft/day  
K(2,6) = 8.775E-06 cm/sec = 2.487E-02 ft/day  
K(3,4) = 7.123E-06 cm/sec = 2.019E-02 ft/day  
K(3,5) = 6.844E-06 cm/sec = 1.940E-02 ft/day  
K(3,6) = 7.002E-06 cm/sec = 1.985E-02 ft/day  
K(4,5) = 6.565E-06 cm/sec = 1.861E-02 ft/day  
K(4,6) = 6.942E-06 cm/sec = 1.968E-02 ft/day  
K(5,6) = 7.319E-06 cm/sec = 2.075E-02 ft/day

Average Hydraulic Conductivity = 1.422E-05 cm/sec  
4.031E-02 ft/day

Dunn Geoscience Corporation

D4-7 (1971) Hydraulic Conductivity Program

Well Identification: BW-4D V

Well Parameters: Diameter = 2.00 inches  
Screen Length = 5.00 feet

Test Type: slug (1 gal)

Test Parameters: Baseline Depth/Pres. = .10  
Initial Depth/Pres. = 99.20  
Time Scale = 6.0000

Time	Depth/Pres.
.00	99.20
40.00	95.50
80.00	92.00
120.00	88.90
160.00	86.10
200.00	83.50

Hydraulic Conductivity Results

K(1,2) = 8.244E-06 cm/sec = 2.337E-02 ft/day  
K(1,3) = 8.171E-06 cm/sec = 2.316E-02 ft/day  
K(1,4) = 7.926E-06 cm/sec = 2.247E-02 ft/day  
K(1,5) = 7.680E-06 cm/sec = 2.177E-02 ft/day  
K(1,6) = 7.474E-06 cm/sec = 2.119E-02 ft/day  
K(2,3) = 8.098E-06 cm/sec = 2.296E-02 ft/day  
K(2,4) = 7.766E-06 cm/sec = 2.201E-02 ft/day  
K(2,5) = 7.491E-06 cm/sec = 2.124E-02 ft/day  
K(2,6) = 7.281E-06 cm/sec = 2.064E-02 ft/day  
K(3,4) = 7.435E-06 cm/sec = 2.107E-02 ft/day  
K(3,5) = 7.188E-06 cm/sec = 2.038E-02 ft/day  
K(3,6) = 7.009E-06 cm/sec = 1.987E-02 ft/day  
K(4,5) = 6.942E-06 cm/sec = 1.968E-02 ft/day  
K(4,6) = 6.796E-06 cm/sec = 1.927E-02 ft/day  
K(5,6) = 6.651E-06 cm/sec = 1.885E-02 ft/day

Average Hydraulic Conductivity = 7.477E-06 cm/sec  
2.119E-02 ft/day

Dunn Geoscience Corporation

DM-7 (1971) Hydraulic Conductivity Program

Well Identification: BW-5 V

Well Parameters: Diameter = 2.00 inches  
Screen Length = 5.00 feet

Test Type: slug (1 gal)

Test Parameters: Baseline Depth/Pres. = .00  
Initial Depth/Pres. = 55.00  
Time Scale = 6.0000

Time	Depth/Pres.
.00	55.00
20.00	29.50
40.00	17.50
60.00	11.00
80.00	7.00
100.00	4.50

Hydraulic Conductivity Results

K(1,2) = 2.699E-04 cm/sec = 7.652E-01 ft/day  
K(1,3) = 2.481E-04 cm/sec = 7.033E-01 ft/day  
K(1,4) = 2.325E-04 cm/sec = 6.590E-01 ft/day  
K(1,5) = 2.233E-04 cm/sec = 6.330E-01 ft/day  
K(1,6) = 2.169E-04 cm/sec = 6.150E-01 ft/day  
K(2,3) = 2.263E-04 cm/sec = 6.414E-01 ft/day  
K(2,4) = 2.137E-04 cm/sec = 6.059E-01 ft/day  
K(2,5) = 2.078E-04 cm/sec = 5.890E-01 ft/day  
K(2,6) = 2.037E-04 cm/sec = 5.774E-01 ft/day  
K(3,4) = 2.012E-04 cm/sec = 5.703E-01 ft/day  
K(3,5) = 1.985E-04 cm/sec = 5.627E-01 ft/day  
K(3,6) = 1.962E-04 cm/sec = 5.561E-01 ft/day  
K(4,5) = 1.959E-04 cm/sec = 5.552E-01 ft/day  
K(4,6) = 1.937E-04 cm/sec = 5.489E-01 ft/day  
K(5,6) = 1.915E-04 cm/sec = 5.427E-01 ft/day

Average Hydraulic Conductivity = 2.146E-04 cm/sec  
6.083E-01 ft/day

Dunn Geoscience Corporation

DM-7 (1971) Hydraulic Conductivity Program

Well Identification: BW-6 V

Well Parameters: Diameter = 2.00 inches  
Screen Length = 10.00 feet

Test Type: slug (1 gal)

Test Parameters: Baseline Depth/Pres. = .00  
Initial Depth/Pres. = 97.50  
Time Scale = 120.0000

Time	Depth/Pres.
.00	97.50
100.00	62.00
200.00	40.50
300.00	26.00
400.00	16.00
500.00	9.50

Hydraulic Conductivity Results

K(1,2) = 4.588E-04 cm/sec = 1.300E+00 ft/day  
K(1,3) = 4.451E-04 cm/sec = 1.262E+00 ft/day  
K(1,4) = 4.465E-04 cm/sec = 1.266E+00 ft/day  
K(1,5) = 4.578E-04 cm/sec = 1.298E+00 ft/day  
K(1,6) = 4.719E-04 cm/sec = 1.338E+00 ft/day  
K(2,3) = 4.315E-04 cm/sec = 1.223E+00 ft/day  
K(2,4) = 4.403E-04 cm/sec = 1.248E+00 ft/day  
K(2,5) = 4.575E-04 cm/sec = 1.297E+00 ft/day  
K(2,6) = 4.752E-04 cm/sec = 1.347E+00 ft/day  
K(3,4) = 4.491E-04 cm/sec = 1.273E+00 ft/day  
K(3,5) = 4.706E-04 cm/sec = 1.334E+00 ft/day  
K(3,6) = 4.898E-04 cm/sec = 1.388E+00 ft/day  
K(4,5) = 4.920E-04 cm/sec = 1.395E+00 ft/day  
K(4,6) = 5.101E-04 cm/sec = 1.446E+00 ft/day  
K(5,6) = 5.283E-04 cm/sec = 1.497E+00 ft/day

Average Hydraulic Conductivity = 4.683E-04 cm/sec  
1.327E+00 ft/day

Dunn Geoscience Corporation

DM-7 (1971) Hydraulic Conductivity Program

Well Identification: BW-7S V

Well Parameters: Diameter = 2.00 inches  
Screen Length = 10.00 feet

Test Type: slug (1gal)

Test Parameters: Baseline Depth/Pres. = 3.30  
Initial Depth/Pres. = 95.75  
Time Scale = 30.0000

Time	Depth/Pres.
.00	95.75
150.00	70.10
300.00	57.30
460.00	46.60
700.00	35.00
1000.00	25.20

Hydraulic Conductivity Results

K(1,2) = 5.488E-05 cm/sec = 1.556E-01 ft/day  
K(1,3) = 4.541E-05 cm/sec = 1.287E-01 ft/day  
K(1,4) = 4.177E-05 cm/sec = 1.184E-01 ft/day  
K(1,5) = 3.874E-05 cm/sec = 1.098E-01 ft/day  
K(1,6) = 3.649E-05 cm/sec = 1.034E-01 ft/day  
K(2,3) = 3.593E-05 cm/sec = 1.018E-01 ft/day  
K(2,4) = 3.543E-05 cm/sec = 1.004E-01 ft/day  
K(2,5) = 3.433E-05 cm/sec = 9.732E-02 ft/day  
K(2,6) = 3.324E-05 cm/sec = 9.422E-02 ft/day  
K(3,4) = 3.497E-05 cm/sec = 9.912E-02 ft/day  
K(3,5) = 3.374E-05 cm/sec = 9.563E-02 ft/day  
K(3,6) = 3.266E-05 cm/sec = 9.259E-02 ft/day  
K(4,5) = 3.292E-05 cm/sec = 9.331E-02 ft/day  
K(4,6) = 3.198E-05 cm/sec = 9.065E-02 ft/day  
K(5,6) = 3.123E-05 cm/sec = 8.853E-02 ft/day

Average Hydraulic Conductivity = 3.691E-05 cm/sec  
1.046E-01 ft/day

Dunn Geoscience Corporation

DM-7 (1971) Hydraulic Conductivity Program

Well Identification: BW-7D.V

Well Parameters: Diameter = 2.00 inches  
Screen Length = 10.00 feet

Test Type: slug (lgal)

Test Parameters: Baseline Depth/Pres. = 9.00  
Initial Depth/Pres. = 50.30  
Time Scale = 6.0000

Time	Depth/Pres.
.00	50.30
20.00	29.10
40.00	19.70
60.00	14.80
80.00	12.00
100.00	10.30

Hydraulic Conductivity Results

K(1,2) = 1.824E-04 cm/sec = 5.172E-01 ft/day  
K(1,3) = 1.711E-04 cm/sec = 4.850E-01 ft/day  
K(1,4) = 1.658E-04 cm/sec = 4.699E-01 ft/day  
K(1,5) = 1.661E-04 cm/sec = 4.708E-01 ft/day  
K(1,6) = 1.752E-04 cm/sec = 4.967E-01 ft/day  
K(2,3) = 1.597E-04 cm/sec = 4.528E-01 ft/day  
K(2,4) = 1.574E-04 cm/sec = 4.463E-01 ft/day  
K(2,5) = 1.606E-04 cm/sec = 4.553E-01 ft/day  
K(2,6) = 1.734E-04 cm/sec = 4.916E-01 ft/day  
K(3,4) = 1.551E-04 cm/sec = 4.398E-01 ft/day  
K(3,5) = 1.611E-04 cm/sec = 4.566E-01 ft/day  
K(3,6) = 1.780E-04 cm/sec = 5.046E-01 ft/day  
K(4,5) = 1.670E-04 cm/sec = 4.734E-01 ft/day  
K(4,6) = 1.894E-04 cm/sec = 5.370E-01 ft/day  
K(5,6) = 2.119E-04 cm/sec = 6.005E-01 ft/day

Average Hydraulic Conductivity = 1.716E-04 cm/sec  
4.865E-01 ft/day

Dunn Geoscience Corporation

D4-7 (1971) Hydraulic Conductivity Program

Well Identification: BW-8S V

Well Parameters: Diameter = 2.00 inches  
Screen Length = 9.12 feet

Test Type: slug (1 gal)

Test Parameters: Baseline Depth/Pres. = .00  
Initial Depth/Pres. = 17.00  
Time Scale = 12.0000

Time	Depth/Pres.
.00	17.00
20.00	9.50
40.00	6.00
60.00	4.00
80.00	2.50
90.00	2.00

Hydraulic Conductivity Results

K(1,2) = 3.171E-04 cm/sec = 8.988E-01 ft/day  
K(1,3) = 2.837E-04 cm/sec = 8.043E-01 ft/day  
K(1,4) = 2.628E-04 cm/sec = 7.449E-01 ft/day  
K(1,5) = 2.611E-04 cm/sec = 7.402E-01 ft/day  
K(1,6) = 2.591E-04 cm/sec = 7.345E-01 ft/day  
K(2,3) = 2.504E-04 cm/sec = 7.098E-01 ft/day  
K(2,4) = 2.357E-04 cm/sec = 6.680E-01 ft/day  
K(2,5) = 2.425E-04 cm/sec = 6.873E-01 ft/day  
K(2,6) = 2.426E-04 cm/sec = 6.876E-01 ft/day  
K(3,4) = 2.209E-04 cm/sec = 6.263E-01 ft/day  
K(3,5) = 2.385E-04 cm/sec = 6.761E-01 ft/day  
K(3,6) = 2.394E-04 cm/sec = 6.787E-01 ft/day  
K(4,5) = 2.561E-04 cm/sec = 7.259E-01 ft/day  
K(4,6) = 2.518E-04 cm/sec = 7.137E-01 ft/day  
K(5,6) = 2.432E-04 cm/sec = 6.893E-01 ft/day

Average Hydraulic Conductivity = 2.537E-04 cm/sec  
7.190E-01 ft/day

Dunn Geoscience Corporation

DM-7 (1971) Hydraulic Conductivity Program

Well Identification: BW-8D V

Well Parameters: Diameter = 2.00 inches  
Screen Length = 10.00 feet

Test Type: slug (1 gal)

Test Parameters: Baseline Depth/Pres. = 10.00  
Initial Depth/Pres. = 93.00  
Time Scale = 60.0000

Time	Depth/Pres.
.00	93.00
80.00	19.30
140.00	13.90
200.00	12.30
240.00	11.90
280.00	11.60

Hydraulic Conductivity Results

K(1,2) = 1.386E-03 cm/sec = 3.930E+00 ft/day  
K(1,3) = 1.107E-03 cm/sec = 3.137E+00 ft/day  
K(1,4) = 9.085E-04 cm/sec = 2.575E+00 ft/day  
K(1,5) = 7.974E-04 cm/sec = 2.260E+00 ft/day  
K(1,6) = 7.146E-04 cm/sec = 2.026E+00 ft/day  
K(2,3) = 7.339E-04 cm/sec = 2.080E+00 ft/day  
K(2,4) = 5.899E-04 cm/sec = 1.672E+00 ft/day  
K(2,5) = 5.029E-04 cm/sec = 1.426E+00 ft/day  
K(2,6) = 4.459E-04 cm/sec = 1.264E+00 ft/day  
K(3,4) = 4.459E-04 cm/sec = 1.264E+00 ft/day  
K(3,5) = 3.644E-04 cm/sec = 1.033E+00 ft/day  
K(3,6) = 3.225E-04 cm/sec = 9.140E-01 ft/day  
K(4,5) = 2.420E-04 cm/sec = 6.860E-01 ft/day  
K(4,6) = 2.298E-04 cm/sec = 6.515E-01 ft/day  
K(5,6) = 2.177E-04 cm/sec = 6.170E-01 ft/day

Average Hydraulic Conductivity = 6.005E-04 cm/sec  
1.702E+00 ft/day



Dunn Geoscience Corporation

DM-7 (1971) Hydraulic Conductivity Program

Well Identification: BW-8br V

Well Parameters: Diameter = 4.00 inches  
Screen Length = 5.00 feet

Test Type: slug (3 gal)

Test Parameters: Baseline Depth/Pres. = 10.00  
Initial Depth/Pres. = 93.70  
Time Scale = 6.0000

Time	Depth/Pres.
.00	93.70
80.00	56.70
160.00	36.50
240.00	25.40
320.00	18.80

Hydraulic Conductivity Results

K(1,2) = 2.100E-04 cm/sec = 5.954E-01 ft/day  
K(1,3) = 2.070E-04 cm/sec = 5.868E-01 ft/day  
K(1,4) = 2.031E-04 cm/sec = 5.758E-01 ft/day  
K(1,5) = 2.027E-04 cm/sec = 5.746E-01 ft/day  
K(2,3) = 2.040E-04 cm/sec = 5.781E-01 ft/day  
K(2,4) = 1.997E-04 cm/sec = 5.660E-01 ft/day  
K(2,5) = 2.003E-04 cm/sec = 5.677E-01 ft/day  
K(3,4) = 1.954E-04 cm/sec = 5.538E-01 ft/day  
K(3,5) = 1.984E-04 cm/sec = 5.624E-01 ft/day  
K(4,5) = 2.014E-04 cm/sec = 5.710E-01 ft/day

Average Hydraulic Conductivity = 2.022E-04 cm/sec  
5.732E-01 ft/day

Dunn Geoscience Corporation

DM-7 (1971) Hydraulic Conductivity Program

Well Identification: BW-10D V

Well Parameters: Diameter = 2.00 inches  
Screen Length = 5.00 feet

Test Type: slug (1 gal)

Test Parameters: Baseline Depth/Pres. = 10.00  
Initial Depth/Pres. = 57.50  
Time Scale = 6.0000

Time	Depth/Pres.
.00	57.50
40.00	47.20
80.00	40.00
120.00	35.00
160.00	31.00
200.00	27.80

Hydraulic Conductivity Results

K(1,2) = 5.296E-05 cm/sec = 1.501E-01 ft/day  
K(1,3) = 4.978E-05 cm/sec = 1.411E-01 ft/day  
K(1,4) = 4.635E-05 cm/sec = 1.314E-01 ft/day  
K(1,5) = 4.421E-05 cm/sec = 1.253E-01 ft/day  
K(1,6) = 4.253E-05 cm/sec = 1.206E-01 ft/day  
K(2,3) = 4.661E-05 cm/sec = 1.321E-01 ft/day  
K(2,4) = 4.305E-05 cm/sec = 1.220E-01 ft/day  
K(2,5) = 4.129E-05 cm/sec = 1.171E-01 ft/day  
K(2,6) = 3.993E-05 cm/sec = 1.132E-01 ft/day  
K(3,4) = 3.950E-05 cm/sec = 1.120E-01 ft/day  
K(3,5) = 3.864E-05 cm/sec = 1.095E-01 ft/day  
K(3,6) = 3.770E-05 cm/sec = 1.069E-01 ft/day  
K(4,5) = 3.778E-05 cm/sec = 1.071E-01 ft/day  
K(4,6) = 3.680E-05 cm/sec = 1.043E-01 ft/day  
K(5,6) = 3.582E-05 cm/sec = 1.015E-01 ft/day

Average Hydraulic Conductivity = 4.220E-05 cm/sec  
1.196E-01 ft/day

Dunn Geoscience Corporation

DM-7 (1971) Hydraulic Conductivity Program

Well Identification: BW-11 V

Well Parameters: Diameter = 2.00 inches  
Screen Length = 5.50 feet

Test Type: slug (2 gal)

Test Parameters: Baseline Depth/Pres. = 10.00  
Initial Depth/Pres. = 20.80  
Time Scale = 60.0000

Time	Depth/Pres.
.00	20.80
40.00	12.10
120.00	11.80
160.00	11.60
200.00	11.00

Hydraulic Conductivity Results

K(1,2) = 3.301E-03 cm/sec = 9.356E+00 ft/day  
K(1,3) = 1.204E-03 cm/sec = 3.412E+00 ft/day  
K(1,4) = 9.622E-04 cm/sec = 2.727E+00 ft/day  
K(1,5) = 9.592E-04 cm/sec = 2.719E+00 ft/day  
K(2,3) = 1.553E-04 cm/sec = 4.403E-01 ft/day  
K(2,4) = 1.827E-04 cm/sec = 5.179E-01 ft/day  
K(2,5) = 3.738E-04 cm/sec = 1.060E+00 ft/day  
K(3,4) = 2.374E-04 cm/sec = 6.729E-01 ft/day  
K(3,5) = 5.923E-04 cm/sec = 1.679E+00 ft/day  
K(4,5) = 9.473E-04 cm/sec = 2.685E+00 ft/day

Average Hydraulic Conductivity = 8.915E-04 cm/sec  
2.527E+00 ft/day

Dunn Geoscience Corporation

DM-7 (1971) Hydraulic Conductivity Program

Well Identification: B-12 V

Well Parameters: Diameter = 2.00 inches  
Screen Length = 2.66 feet

Test Type: slug (2 gal)

Test Parameters: Baseline Depth/Pres. = 10.00  
Initial Depth/Pres. = 31.50  
Time Scale = 6.0000

Time	Depth/Pres.
.00	31.50
20.00	22.80
40.00	18.10
60.00	16.10
80.00	14.80
100.00	14.00

Hydraulic Conductivity Results

K(1,2) = 3.573E-04 cm/sec = 1.013E+00 ft/day  
K(1,3) = 3.363E-04 cm/sec = 9.532E-01 ft/day  
K(1,4) = 2.893E-04 cm/sec = 8.201E-01 ft/day  
K(1,5) = 2.583E-04 cm/sec = 7.321E-01 ft/day  
K(1,6) = 2.317E-04 cm/sec = 6.569E-01 ft/day  
K(2,3) = 3.153E-04 cm/sec = 8.936E-01 ft/day  
K(2,4) = 2.553E-04 cm/sec = 7.237E-01 ft/day  
K(2,5) = 2.252E-04 cm/sec = 6.385E-01 ft/day  
K(2,6) = 2.003E-04 cm/sec = 5.679E-01 ft/day  
K(3,4) = 1.954E-04 cm/sec = 5.538E-01 ft/day  
K(3,5) = 1.802E-04 cm/sec = 5.109E-01 ft/day  
K(3,6) = 1.620E-04 cm/sec = 4.593E-01 ft/day  
K(4,5) = 1.651E-04 cm/sec = 4.681E-01 ft/day  
K(4,6) = 1.454E-04 cm/sec = 4.121E-01 ft/day  
K(5,6) = 1.256E-04 cm/sec = 3.561E-01 ft/day

Average Hydraulic Conductivity = 2.295E-04 cm/sec  
6.506E-01 ft/day

Dunn Geoscience Corporation

DM-7 (1971) Hydraulic Conductivity Program

Well Identification: BW-13 V

Well Parameters: Diameter = 2.00 inches  
 Screen Length = 5.00 feet

Test Type: slug (1 gal)

Test Parameters: Baseline Depth/Pres. = 11.90  
 Initial Depth/Pres. = 72.10  
 Time Scale = 12.0000

Time	Depth/Pres.
.00	72.10
60.00	55.70
120.00	44.90
180.00	38.30
240.00	33.80
300.00	30.00

Hydraulic Conductivity Results

K(1,2) = 9.187E-05 cm/sec = 2.604E-01 ft/day  
 K(1,3) = 8.683E-05 cm/sec = 2.461E-01 ft/day  
 K(1,4) = 7.938E-05 cm/sec = 2.250E-01 ft/day  
 K(1,5) = 7.303E-05 cm/sec = 2.070E-01 ft/day  
 K(1,6) = 6.943E-05 cm/sec = 1.968E-01 ft/day  
 K(2,3) = 8.179E-05 cm/sec = 2.318E-01 ft/day  
 K(2,4) = 7.313E-05 cm/sec = 2.073E-01 ft/day  
 K(2,5) = 6.675E-05 cm/sec = 1.892E-01 ft/day  
 K(2,6) = 6.382E-05 cm/sec = 1.809E-01 ft/day  
 K(3,4) = 6.446E-05 cm/sec = 1.827E-01 ft/day  
 K(3,5) = 5.922E-05 cm/sec = 1.679E-01 ft/day  
 K(3,6) = 5.783E-05 cm/sec = 1.639E-01 ft/day  
 K(4,5) = 5.398E-05 cm/sec = 1.530E-01 ft/day  
 K(4,6) = 5.452E-05 cm/sec = 1.545E-01 ft/day  
 K(5,6) = 5.505E-05 cm/sec = 1.561E-01 ft/day

Average Hydraulic Conductivity = 6.874E-05 cm/sec  
 1.949E-01 ft/day

Dunn Geoscience Corporation

DM-7 (1971) Hydraulic Conductivity Program

Well Identification: BW-14 V

Well Parameters: Diameter = 2.00 inches  
Screen Length = 10.00 feet

Test Type: slug (1 gal)

Test Parameters: Baseline Depth/Pres. = .00  
Initial Depth/Pres. = 81.10  
Time Scale = 30.0000

Time	Depth/Pres.
.00	81.10
40.00	43.10
80.00	31.40
120.00	20.10
160.00	12.30
200.00	7.00

Hydraulic Conductivity Results

K(1,2) = 3.309E-04 cm/sec = 9.379E-01 ft/day  
K(1,3) = 3.005E-04 cm/sec = 8.518E-01 ft/day  
K(1,4) = 2.945E-04 cm/sec = 8.348E-01 ft/day  
K(1,5) = 2.986E-04 cm/sec = 8.465E-01 ft/day  
K(1,6) = 3.103E-04 cm/sec = 8.796E-01 ft/day  
K(2,3) = 2.701E-04 cm/sec = 7.657E-01 ft/day  
K(2,4) = 2.763E-04 cm/sec = 7.833E-01 ft/day  
K(2,5) = 2.879E-04 cm/sec = 8.161E-01 ft/day  
K(2,6) = 3.052E-04 cm/sec = 8.651E-01 ft/day  
K(3,4) = 2.825E-04 cm/sec = 8.009E-01 ft/day  
K(3,5) = 2.968E-04 cm/sec = 8.413E-01 ft/day  
K(3,6) = 3.169E-04 cm/sec = 8.982E-01 ft/day  
K(4,5) = 3.110E-04 cm/sec = 8.817E-01 ft/day  
K(4,6) = 3.340E-04 cm/sec = 9.469E-01 ft/day  
K(5,6) = 3.570E-04 cm/sec = 1.012E+00 ft/day

Average Hydraulic Conductivity = 3.048E-04 cm/sec  
8.641E-01 ft/day

Dunn Geoscience Corporation

DM-7 (1971) Hydraulic Conductivity Program

Well Identification: BW-15 V

Well Parameters: Diameter = 2.00 inches  
Screen Length = 10.00 feet

Test Type: slug (1 gal)

Test Parameters: Baseline Depth/Pres. = 10.00  
Initial Depth/Pres. = 86.00  
Time Scale = 60.0000

Time	Depth/Pres.
.00	86.00
60.00	26.50
120.00	16.30
180.00	13.10
240.00	11.90
280.00	11.40

Hydraulic Conductivity Results

K(1,2) = 1.290E-03 cm/sec = 3.656E+00 ft/day  
K(1,3) = 1.051E-03 cm/sec = 2.980E+00 ft/day  
K(1,4) = 9.006E-04 cm/sec = 2.553E+00 ft/day  
K(1,5) = 7.788E-04 cm/sec = 2.208E+00 ft/day  
K(1,6) = 7.228E-04 cm/sec = 2.049E+00 ft/day  
K(2,3) = 8.131E-04 cm/sec = 2.305E+00 ft/day  
K(2,4) = 7.060E-04 cm/sec = 2.001E+00 ft/day  
K(2,5) = 6.084E-04 cm/sec = 1.725E+00 ft/day  
K(2,6) = 5.681E-04 cm/sec = 1.610E+00 ft/day  
K(3,4) = 5.988E-04 cm/sec = 1.698E+00 ft/day  
K(3,5) = 5.061E-04 cm/sec = 1.435E+00 ft/day  
K(3,6) = 4.763E-04 cm/sec = 1.350E+00 ft/day  
K(4,5) = 4.134E-04 cm/sec = 1.172E+00 ft/day  
K(4,6) = 4.028E-04 cm/sec = 1.142E+00 ft/day  
K(5,6) = 3.868E-04 cm/sec = 1.097E+00 ft/day

Average Hydraulic Conductivity = 6.815E-04 cm/sec  
1.932E+00 ft/day

Dunn Geoscience Corporation

DM-7 (1971) Hydraulic Conductivity Program

Well Identification: BW-16 V

Well Parameters: Diameter = 2.00 inches  
Screen Length = 5.00 feet

Test Type: slug (1 gal)

Test Parameters: Baseline Depth/Pres. = 9.90  
Initial Depth/Pres. = 69.90  
Time Scale = 30.0000

Time	Depth/Pres.
.00	69.90
80.00	28.10
160.00	16.50
240.00	11.90
270.00	11.00

Hydraulic Conductivity Results

K(1,2) = 6.461E-04 cm/sec = 1.832E+00 ft/day  
K(1,3) = 5.978E-04 cm/sec = 1.695E+00 ft/day  
K(1,4) = 6.141E-04 cm/sec = 1.741E+00 ft/day  
K(1,5) = 6.418E-04 cm/sec = 1.819E+00 ft/day  
K(2,3) = 5.494E-04 cm/sec = 1.557E+00 ft/day  
K(2,4) = 5.981E-04 cm/sec = 1.695E+00 ft/day  
K(2,5) = 6.400E-04 cm/sec = 1.814E+00 ft/day  
K(3,4) = 6.467E-04 cm/sec = 1.833E+00 ft/day  
K(3,5) = 7.058E-04 cm/sec = 2.001E+00 ft/day  
K(4,5) = 8.635E-04 cm/sec = 2.448E+00 ft/day

Average Hydraulic Conductivity = 6.503E-04 cm/sec  
1.843E+00 ft/day



Dunn Geoscience Corporation

DM-7 (1971) Hydraulic Conductivity Program

Well Identification: BW-17 V

Well Parameters: Diameter = 2.00 inches  
Screen Length = 5.00 feet

Test Type: slug (1 gal)

Test Parameters: Baseline Depth/Pres. = 10.40  
Initial Depth/Pres. = 58.70  
Time Scale = 6.0000

Time	Depth/Pres.
.00	58.00
80.00	43.80
160.00	35.00
240.00	28.50
280.00	26.10

Hydraulic Conductivity Results

K(1,2) = 3.838E-05 cm/sec = 1.088E-01 ft/day  
K(1,3) = 3.575E-05 cm/sec = 1.013E-01 ft/day  
K(1,4) = 3.492E-05 cm/sec = 9.897E-02 ft/day  
K(1,5) = 3.433E-05 cm/sec = 9.731E-02 ft/day  
K(2,3) = 3.313E-05 cm/sec = 9.391E-02 ft/day  
K(2,4) = 3.318E-05 cm/sec = 9.406E-02 ft/day  
K(2,5) = 3.271E-05 cm/sec = 9.272E-02 ft/day  
K(3,4) = 3.324E-05 cm/sec = 9.422E-02 ft/day  
K(3,5) = 3.243E-05 cm/sec = 9.194E-02 ft/day  
K(4,5) = 3.082E-05 cm/sec = 8.736E-02 ft/day

Average Hydraulic Conductivity = 3.389E-05 cm/sec  
9.606E-02 ft/day

Dunn Geoscience Corporation

DM-7 (1971) Hydraulic Conductivity Program

Well Identification: B7-17a V

Well Parameters: Diameter = 2.00 inches  
Screen Length = 10.00 feet

Test Type: slug (1 gal)

Test Parameters: Baseline Depth/Pres. = 2.00  
Initial Depth/Pres. = 83.00  
Time Scale = 12.0000

Time	Depth/Pres.
.00	83.00
15.00	43.00
30.00	24.20
45.00	13.50
60.00	7.30
75.00	3.50

Hydraulic Conductivity Results

K(1,2) = 4.600E-04 cm/sec = 1.304E+00 ft/day  
K(1,3) = 4.372E-04 cm/sec = 1.239E+00 ft/day  
K(1,4) = 4.396E-04 cm/sec = 1.246E+00 ft/day  
K(1,5) = 4.605E-04 cm/sec = 1.305E+00 ft/day  
K(1,6) = 5.390E-04 cm/sec = 1.528E+00 ft/day  
K(2,3) = 4.144E-04 cm/sec = 1.175E+00 ft/day  
K(2,4) = 4.294E-04 cm/sec = 1.217E+00 ft/day  
K(2,5) = 4.607E-04 cm/sec = 1.306E+00 ft/day  
K(2,6) = 5.587E-04 cm/sec = 1.584E+00 ft/day  
K(3,4) = 4.444E-04 cm/sec = 1.260E+00 ft/day  
K(3,5) = 4.838E-04 cm/sec = 1.372E+00 ft/day  
K(3,6) = 6.068E-04 cm/sec = 1.720E+00 ft/day  
K(4,5) = 5.233E-04 cm/sec = 1.483E+00 ft/day  
K(4,6) = 6.880E-04 cm/sec = 1.950E+00 ft/day  
K(5,6) = 8.527E-04 cm/sec = 2.417E+00 ft/day

Average Hydraulic Conductivity = 5.199E-04 cm/sec  
1.474E+00 ft/day