

APPENDIX FOR:

**REMEDIAL INVESTIGATION
GE / MOREAU SITE
11- CERCLA - 30201**

APPENDIX VOLUME I APPENDICES A - F

prepared for:

**GENERAL  ELECTRIC
Schenectady , New York**

prepared by:

Dunn Geoscience Corporation

October 1984

TABLE OF CONTENTS

Appendix A	Remedial Investigation Work Plan and Implementation Schedule
Appendix B	Soil Boring Logs Monitoring Well Construction Details
Appendix C	Photoionization Results
Appendix D	Horizontal Hydraulic Conductivity Field Results Vertical Hydraulic Conductivity Falling-Head Field Test Results Laboratory Constant Head Triaxial Permeability Results Laboratory Triaxial Permeability Test Report Forms
Appendix E	New York State Department of Health Procedure for the Analysis of Volatile Organic Compounds in Soil Domestic Well Sampling Protocols Near-Surface Soil Sampling Protocols; Letter of Acceptance
Appendix F	Grain-Size Distribution Analyses

REMEDIAL INVESTIGATION
WORK PLAN AND IMPLEMENTATION SCHEDULE
GE Moreau Site
Index No. 11-CERCLA-30201

Prepared By
DUNN GEOSCIENCE CORPORATION
Latham, New York

March 28, 1984

TABLE OF CONTENTS

	<u>page</u>
INTRODUCTION	1
WASTE CHARACTERIZATION	1
HYDROGEOLOGIC SETTING	2
Literature Review	2
Geophysical Survey	3
Test-Hole Drilling	3
AQUIFER CHARACTERISTICS	5
Monitoring Well Installation	5
Hydraulic Conductivity Testing	7
EXTENT OF GROUND-WATER CONTAMINATION	8
Well Placement	8
Water-Quality Sampling	9
INFLUENCE OF PUMPING WELLS	10
GROUND-WATER MODELING	10
SOILS - EXTENT OF CONTAMINATION	10
SURFACE WATER - EXTENT OF CONTAMINATION	11
AIR MONITORING	11
HEALTH AND SAFETY PLAN	12
Attachment 1 - Protocol For Volatile Organic Screening of Split-Spoon Samples	
Attachment 2 - Protocol For Ground-Water Sampling	
Attachment 3 - Soil Sampling Protocol	
Attachment 4 - Surface Water Sampling Protocol	
Schedule of Implementation	
Figure 1 - Proposed Locations of Geophysical Survey	
Figure 2 - Air Quality Monitoring Stations and Proposed Cluster Well Locations	

REMEDIAL INVESTIGATION
WORK PLAN AND IMPLEMENTATION SCHEDULE
GE Moreau Site
Index No. 11-CERCLA-30201
Prepared by Dunn Geoscience Corporation
March 28, 1984

INTRODUCTION

This work plan addresses a remedial investigation to define the nature and extent of off-site contaminant migration at the GE Moreau site in compliance with Item II, U.S. EPA Administrative Order 11-CERCLA-30201. It describes the methodologies to be used to characterize waste at the site, the geology, to determine the aquifer characteristics, and to determine the velocity and direction of ground-water movement and nature and extent of contaminant migration.

WASTE CHARACTERIZATION

Detailed characterization of the waste site and the wastes emplaced at the site is invaluable in designing a hydrogeologic remedial investigation. It provides the background regarding the entrainment of contamination into the aquifer system, the duration of the contamination event, and the nature of the contaminants. Most of this information has already been compiled and has been submitted to the EPA in the form of an engineering report prepared by O'Brien and Gere, Syracuse, New York. A review of this information has been performed to aid in the design of the ground-water quality monitoring system and monitoring program discussed herein as part of the remedial investigation.

Special attention has been given to the following data:

- o the type of wastes disposed
- o the volume of wastes disposed
- o the disposal practices followed
- o the periods when disposal took place

- o mobility of the wastes
- o persistence of the wastes
- o waste removal procedures implemented
- o residual waste at the site

All of the information will be utilized in determining the extent of contamination and the rate of contaminant migration.

HYDROGEOLOGIC SETTING

The hydrogeologic setting of the site will be determined from a literature review, geophysical surveys, and test-hole drilling. Also, some existing wells will be utilized to the extent possible to provide supplementary information.

Literature Review

Much is already known about the hydrogeology from existing consultants reports and from publications. The literature review will include the following:

1. Previous consultants reports, i.e., Migration of PCB's from Landfills and Dredge Spoil Sites in the Hudson River Valley, Weston (1978); PCB's Removal from the Caputo Site on December 18 & 20, 1978 Town of Moreau, Saratoga County, New York, Hardick Associates (1978); Conceptual Engineering Study of Five Disposal Sites Known to have Received PCB Wastes, Wehran (1980); Caputo Site Engineering Report, Caputo Site Engineering Report Addendum, Caputo Site Remedial Program Final Plan-Subsurface Investigation, O'Brien and Gere (1981, 1982a, and 1982b); and Investigation of Ground Water Contamination in the Vicinity of the GE Moreau (Caputo) Site, C.A. Rich (1983).
2. U.S.G.S. and NYS Geological Survey reports, topographic maps, aerial photos, and files.

3. Other publicly available reports or records related to studies at the site.

The information available from these documents will be evaluated particularly from the standpoint of what additional information is indicated as being necessary. Test drilling and geophysical surveys will be performed to provide such information.

Geophysical Survey

A geophysical reconnaissance utilizing terrain conductivity (EM-34), and other geophysical methods will, if necessary, be undertaken to supplement test-hole drilling. Tentative locations for the survey are shown in Figure 1. The focus of the survey will be to locate the bottom of the sand aquifer represented by a relatively impermeable clay layer. The survey will involve measuring terrain conductivity at relatively widely-spaced intervals. The measurements will be integrated with test-hole data to develop a configuration of the aquifer base.

Test-Hole Drilling

Test-hole drilling and subsequent monitoring well installation will comprise the most extensive portion of the remedial investigation. The test-hole drilling will be conducted in phases to allow data which is collected to be evaluated before additional drilling is initiated. Each phase of test-hole drilling will be integrated with other field activities to meet the following objectives:

- define the extent of ground-water contamination by evaluating ground-water chemical composition in samples drawn systematically from monitoring wells;
- locate zones of preferential ground-water flow which may favor certain contaminant pathways;

- determine the types, properties, and thicknesses of aquifer materials by obtaining formation samples;
- plot stratigraphy by correlating data from different test holes;
- determine aquifer hydraulic characteristics by in-situ testing;
- determine the water-table elevation in the sand aquifer, the seasonal fluctuations of that water table, the hydraulic gradient, and the direction of ground-water flow through periodic water-level measurements; and,
- confirm results of any geophysical surveys.

In the first phase of drilling, a minimum of 17 borings will be advanced, 13 of which are shown on Figure 2. The drilling of each soil boring will be under the direction and supervision of an experienced geologist. The geologist will also log each soil boring following the Modified Burmister System and Unified Soil Classification System. Soil samples will be collected by split-spoon following ASTM Methods for standard 5-foot intervals. Continuous split-spoon samples will initially be taken in several test borings to more completely identify the stratigraphy of the unconsolidated deposits. The samples will be taken through the layer of principle concern, specifically the zone of interbedded sand, silt, and clay. All collected samples will be placed in jars, labeled, and retained for subsequent evaluation and laboratory gradation analyses.

Soil samples will be tested with a portable organic vapor analyzer to determine the presence or absence of volatile halogenated organics. The protocol for this determination is included as attachment 1 to the plan. These test results will be used during monitoring well installation to determine screen placement. Selected soil samples will be sent to the laboratory for analysis of TCE.

Gradation analyses following ASTM standard method will also be performed on selected samples to check visual classifications, to aid in the

selection of monitoring well screens, and to estimate hydraulic conductivity and porosity.

AQUIFER CHARACTERISTICS

The hydraulic characteristics of the aquifer will be determined during and subsequent to the installation of monitoring wells. Ground-water flow velocities and hydraulic gradients will be determined on the basis of water levels measured periodically in the monitoring wells.

The uppermost aquifer is an unconfined sand and gravel aquifer. Downward movement of ground water is confined by a relatively thick glacio-lacustrine silt clay layer. Beneath the clay and underlying till either shale, or most likely, carbonate bedrock occurs.

Investigations conducted to date, and cited earlier, indicate that the contamination occurs in the upper aquifer, suggesting that contaminant migration is also confined by the relatively thick clay layer; therefore, the major investigatory effort is directed to this aquifer.

Characterization of this sand aquifer will involve a review of existing data, construction of monitoring wells, aquifer testing, and ground-water modeling. A relatively large amount of data has already been gathered by General Electric, NYS, and the Town of Moreau. The review of data will result in 1) an inventory of existing wells, both private and public, their locations, construction details, use, and influence on ground-water movement due to pumpage, 2) a compilation of historical aquifer test data and results, and 3) data on stream flows, spring discharges, and precipitation.

Monitoring Well Installation

The design and installation of monitoring wells will be performed in conjunction with the test-hole drilling. Information from the test-hole drilling will aid in the selection of specific stratigraphic units to be monitored. These units will, in turn, determine the position and length

of the well screen for each monitoring well. The vertical position of each horizon to be monitored will determine the number of monitoring wells to be installed at each of the 17 phase I soil boring locations. Two or more completed monitoring wells at each soil boring location will constitute a well cluster. Each well in a cluster will be a separate unit spaced a minimum of five feet from adjacent monitoring wells.

The well clusters will be designed to provide a vertical profile of hydraulic heads and water quality. Wells installed at the top of the aquifer will be screened to monitor the entire range of water-table fluctuation. Monitoring wells installed in the unconsolidated aquifer will be placed in 4-inch borings advanced by either hollow-stem auger or flush-joint casing. The monitoring wells will be constructed of schedule 40, 2-inch diameter PVC riser pipe and slotted or wire-wrapped well screen.

Potential interference on the chemical quality of ground-water samples will be mitigated by adherence to the following procedures:

- only rigid PVC will be used in well construction to eliminate the effects of plasticizers;
- all PVC components will be washed with a strong detergent solution and rinsed thoroughly with cool water;
- all PVC joint connections will be mechanical;
- prior to sampling, four well volumes will be pumped from each well to remove stagnant water;
- to minimize contact time between the formation water and PVC, samples will be collected with a teflon point-source bailer immediately after the required four volumes have been removed.

Each well screen will be surrounded by a clean silica sand pack with a 5-foot bentonite seal placed above the top of the sand pack. The

remainder of the borehole around the riser pipe will be backfilled with a bentonite slurry. The upper 5 feet of the borehole will be sealed with cement to prevent surface contamination from entering the well and to secure a protective steel casing and locking cap placed over the PVC riser pipe. Upon completion each of the 2-inch piezometers will be flushed clean and developed in accordance with Section 5C of the Manual of Ground-Water Quality Sampling Procedures, Scaif, et al, Robert S. Kerr, Environmental Research Laboratory, USEPA, to provide free exchange with the adjacent aquifer.

The location and measuring point elevation of each well will be surveyed so that all geohydrologic data obtained may be accurately plotted in units of feet above mean sea level.

Hydraulic Conductivity Testing

The hydraulic characteristics of the aquifer will be determined through aquifer testing utilizing slug or bail tests at selected wells. The selection of wells to be used for these tests will be made in consultation with EPA.

The tests will be short duration tests designed to determine hydraulic conductivity in the immediate vicinity of the test well. These tests will be performed in a sufficient number of wells to test all portions of the unconsolidated aquifer. The specific wells to be tested will be determined in the field based on the logs of the split-spoon samples.

Vertical hydraulic conductivity values will be determined during test-hole drilling. Falling head tests will be conducted through open-ended casing seated at depths equivalent to final screen setting.

The hydraulic conductivity values will be combined with measurements of hydraulic gradient and estimates of effective porosity to determine the average linear velocity of ground water using a modified form of the Darcy equation.

EXTENT OF GROUND-WATER CONTAMINATION

Well Placement

A systematic approach of well placement will be followed to determine the vertical and areal extent of ground-water contamination. Refer to Figure 2 for the placement of the various series of well installations.

During the first phase of drilling, a line of five well clusters will be located approximately 4500 feet downgradient of the site. The line will parallel the edge of the scarp which occurs in this area. The clusters will be used to obtain water samples to monitor ground-water immediately upgradient of a number of surface-water reservoirs. If contamination is detected, water-quality data from the clusters will also aid in delineating the extent of contamination.

A second series of four monitoring well clusters will be located downgradient of the facility in a line parallel to the direction of ground-water flow as determined by prior investigations. The clusters will extend from the facility to the well clusters which are located along the scarp. Water-quality information from these wells will provide estimates of the distance contamination may have traveled.

A third series of four well clusters will be located on a line approximately perpendicular to the direction of ground-water flow. These wells will aid in delineating the width of the contaminated zone. Due to the tentative nature of the well locations, this series is not shown on Figure 2. This line of wells will be located downgradient of the facility at a distance which is estimated to represent the center of contamination. The distance in question will be estimated from examination of formation samples collected during installation of the second series of wells.

A fourth series of four wells will be installed between 1000 feet and 1500 feet downgradient of the facility. These wells will monitor ground-water quality between the disposal facility and the residential

areas on Bluebird Road and Terry and Cheryl Drives.

It is expected that this distribution of monitoring wells will provide a preliminary estimate of the extent of the contaminated area. This same well configuration will also be used to monitor future expansion or contraction of the contaminated area. The vertical thickness of the contaminated zone will also be determined since well clusters, rather than individual wells will be installed at most locations. As explained earlier, the depths of each well in a cluster will be determined in the field on the basis of formation sample examination.

A second phase of drilling may, nevertheless, be necessary to precisely define the areal limits of contamination. Wells installed during the second, and any subsequent, phase of drilling will be located only after data collected in all earlier phases has been evaluated by both EPA and the respondent. This evaluation will improve choices made regarding future well placement and screen location. Consequently, definition of the contaminated zone will proceed more quickly and rapidly than would occur if a haphazard or otherwise random well location program were followed.

Water-Quality Sampling

Water-quality sampling will be conducted at each monitoring well location. Sampling methods will follow established protocols included as attachment 2 to the plan. Initial evaluation of the analytical results will allow the extent and degree of contamination to be defined on a preliminary basis both areally and vertically. Analyses of the results will determine the scope of any additional work that may be needed.

Repeat sampling will be conducted after each additional phase of drilling has been completed to improve definition of the contaminated zone. Periodic sampling will be continued to monitor changes in the contaminated zone.

INFLUENCE OF PUMPING WELLS

A survey of wells pumping in the area will be conducted. Wells whose pumping rates may present a significant impact on ground-water levels and movement will be identified and monitored through wells installed during the first phase of drilling, if possible. Areas of concentrated domestic pumping will also be identified and monitored. Monitoring will involve the use of continuous water-level recorders to evaluate possible changes in water level which could alter contaminant migration. If well clusters installed during the first phase do not meet the location requirements for accurate monitoring of the pumping wells, additional wells to meet these needs will be installed during the second phase of drilling.

GROUND-WATER MODELING

As practical, ground-water modeling will be used to analyze the flow and contaminant transport behavior of the water-table aquifer. Ground-water gradients and velocities will be determined.

Throughout the study, models of varying complexity may be used - i.e., conceptual models, analytical models, and, if necessary, numerical models requiring computer solutions.

SOILS - EXTENT OF CONTAMINATION

A reconnaissance will be conducted to identify potential sites of soil contaminated by PCBs. The reconnaissance will focus on the area within a 1000-foot radius of the site plus access roads to the facility which are located outside this area, and other areas suggested by the data.

The reconnaissance will involve visual observation of field conditions and a survey with a portable analyzer to detect potential "hot spots". The portable analyzer will be used to detect volatile organics which are presumed to occur in association with the PCBs. The reconnaissance will be preceded by an examination of historical aerial photos of the facility and surrounding environments. Any visible evidence of surface

contamination such as past disposal areas will be noted and field-checked during the reconnaissance.

Any areas identified in the field as potential "hot spots" will undergo soil sampling. If the reconnaissance fails to detect any "hot spots", sampling will be conducted at three randomly chosen locations. Each location will be sampled once following protocols provided as attachment 3 to the plan.

SURFACE WATER - EXTENT OF CONTAMINATION

As discussed previously, five monitoring well clusters will be installed approximately 4000 feet downgradient of the facility. These clusters will monitor ground water flowing from the site towards surface water reservoirs located farther downgradient. Furthermore, water-quality samples for volatile organic analyses will be collected every two weeks from each reservoir as proposed in the plan for Immediate Corrective Action, submitted to EPA on March 14, 1984.

In addition, a survey of the immediate area will be conducted and other surface water bodies near the site will be identified. Single grab samples for volatile organic analysis will be collected from any other sampling points identified in the survey. If the results of the sampling are positive, follow-up sampling will be conducted to confirm the measurements and to monitor any changes.

Except for the actual sample collection, methodologies for surface water sampling parallel those developed for private residence sampling. Protocols to be followed in surface water sampling are provided as attachment 4 to the plan.

AIR MONITORING

The NYS Department of Environmental Conservation has established two air quality monitoring stations in the vicinity of the GE Moreau site. The locations of these stations are shown on the attached map. The stations were activated in August, 1983, and were shut down in mid-November, 1983, when

when site work commences again in the Spring of 1984.

These stations monitor PCBs, trichloroethylene, benzene, methylene chloride and total suspended particulate. The detection limit for PCBs is 20 ng/m³, for TCE is 5 ug/m³, and for benzene is 10 ug/m³. To date, all results were below detection limits with one exception: On November 2, 1983, the 24-hour average benzene concentration was found to be 18 ug/m³ at the station near Terry Drive. It is thought highly unlikely that the GE Moreau site was the source of the benzene.

Remedial action at the site, including trenching and construction of a slurry wall, will take place concurrently with the off-site remedial investigation. Since the on-site activity will generate higher ambient concentrations of volatile organic compounds than the off-site activity, it would be impossible to measure separately ambient levels caused by off-site conditions alone. Therefore, no additional air monitoring stations will be established.

HEALTH AND SAFETY PLAN

A worker health and safety plan will be in effect during test hole drilling and well installation. This plan will provide guidance to ensure worker protection from exposure to hazardous chemicals should such be encountered. Specific aspects of the health and safety plan include general safety protocol, required safety equipment and clothing, decontamination procedures, emergency response, and communications. A safety officer will be appointed by the project manager.

The remedial investigation will be conducted in downgradient areas away from the actual disposal facility. Consequently, it is anticipated that no significant contaminant levels will be encountered. Earlier investigations in the downgradient areas were performed under standard industrial safety guidelines. Since this investigation will be conducted in downgradient areas removed from the disposal facility, the same level of safety requirements will be instituted during the proposed remedial investigation.

However, since small potential dermal and respiratory hazards may exist in isolated areas, the required level of protection will be upgraded to include additional protective clothing and respiratory protection if ambient organic vapor concentrations exceed 10 ppm. The additional protective clothing will include water and chemical resistant coveralls, gloves, boots and safety glasses.

Specific aspects of the plan are outlined below:

1. General Safety Requirements

- a. The immediate work area will be conspicuously marked.
- b. No food or drink may be consumed within the immediate work area.
- c. Smoking will not be permitted within the immediate work area.

2. Required Safety Equipment and Clothing

All persons involved in drilling or soil sample collection/handling will be required to wear certain safety equipment as follows:

- a. Drilling
 1. hard hats
 2. coveralls
 3. safety shoes/boots
- b. Soil Sampling/Drilling Supervision
 1. hard hats
 2. coveralls
 3. disposable gloves

Respirators which have been properly fit-tested will also be available for all personnel. A portable organic vapor analyzer will also be used at the site to determine the presence of volatile organics.

3. Decontamination Procedures

- a. Gloves will be disposed of or decontaminated after sample contact.
- b. Coveralls will be stored with the drill rig and not removed from the immediate work area except for disposal or cleaning.
- c. All auger flights, drill casing, drill rods and associated equipment used in the drilling of each soil boring will be steam-cleaned to remove all visible foreign matter prior to being used in the drilling of the next boring.

4. Emergency Information

The following information will be posted to be readily available to all on-site personnel.

- a. Location of nearest telephone or car radio.
- b. Local/plant fire department telephone number.
- c. Local/plant rescue department telephone number.
- d. Subcontractor offices (drillers, etc.) telephone number.
- e. Chemtrek telephone number.
- f. Project manager telephone number.

5. Emergency Rescue Equipment

The following equipment will be stored at the immediate work area:

- a. First aid kit.
- b. Oxygen kit.
- c. Burn kit.
- d. Rope.
- e. Blanket.

PROTOCOL FOR
VOLATILE ORGANIC SCREENING OF
SPLIT-SPOON SAMPLES

1. Prepare a standard quantity of the split-spoon sample and place it in a clean, tall, narrow, glass jar.
2. Seal the jar with metal foil and a screw cap. Label the cap with the sample identification number.
3. Warm the sample jar to a temperature of 40°C for 30 minutes by placing it in a small portable heater.
4. Remove the screw cap, pierce the metal foil, and sample the headspace with the probe of an HNU portable organic vapor analyzer, or similar instrument.
5. Record the sample number and the results of the analysis in the field notebook.
6. Recap the jar and store it securely for subsequent study, if necessary.

PROTOCOL FOR
GROUND-WATER SAMPLING

All wells will be exercised or thoroughly flushed of standing water in order that they contain fresh water from the aquifer before sampling begins. Because bailing can be very time-consuming when a large number of wells are involved, the wells will be exercised with a non-contaminating submersible pump. In all cases, the actual sample will be withdrawn using a teflon point-source bailer. The procedures are explained in detail below:

1. Identify the well and record the location on the Ground-Water Sampling Field Log.
2. Cut a slit in one side of a plastic sheet and slip it over and around the well creating a clean surface onto which the sampling equipment can be positioned. This clean working area should be a minimum of 10 feet by 10 feet. Do not kick, transfer, drop, or in any way let soils or other materials fall onto this sheet unless it comes from inside the well. Do not place meters, tools, equipment, etc., on the sheet unless they are clean and dry.
3. Put on a new pair of disposable gloves.
4. Clean the well cap with a clean rag and remove the well cap and plug, placing both on the plastic sheet.
5. Clean the first ten feet of a steel 100-foot tape. Rinse first with fresh water. Follow this with a methanol rinse, a hexane rinse, a

second methanol rinse, and finally a rinse with distilled water. The water and solvent rinses can be applied with squeeze bottles. Measure the depth to the water table with the steel tape. Record this information on the Ground-Water Sampling Field Log (attached).

6. Compute the volume of water in the well using the formulae and information provided on the Ground-Water Sampling Field Log. Record this volume on the field log.
7. Prepare the submersible pump for operation.
8. Lower the pump intake to the upper portion of the water column as far above the well screen as possible. (Shallow water-table wells are constructed so that the pump can only be set opposite the screened interval).
9. Start the pump and remove approximately one half quart of this water from the surface of the well water into a new glass quart bottle. Observe the appearance of this water. Return this quart bottle to its proper transport container. Note: This sample will not undergo laboratory analysis, and is collected to observe the physical appearance of the ground water only.
10. Record the physical appearance of the ground water on the Ground-Water Sampling Field Log.
11. Initiate pumping from the well into a graduated pail until four times the volume of water in the well has been removed or until the well is pumped dry. The pump should be lowered in the well until the final intake position is a few feet below the water level established in the well after drawdown reaches equilibrium.
12. If water being withdrawn becomes turbid during the exercising process or during sampling, terminate pumping or sampling until the well is redeveloped at a later time.

13. Remove the pump from the well, place it on the plastic sheet, and prepare to collect the sample with a dedicated teflon point-source bailer.
14. Remove the sampling bottles from their transport containers and prepare the bottles for receiving samples. Inspect all labels to insure proper sample identification. Sample bottles should be kept cool with their caps on until they are ready to receive samples. Arrange the sampling containers to allow for convenient filling.
15. Initiate sampling by lowering the bailer slowly into the well to a depth opposite the midpoint of the screened interval. Remove the bailer in a smooth continuous manner to prevent the check valves from reopening and adulterating the sample. Minimize agitation of the water in the well. Fill each sample container following the instructions listed on Attachment A - Sample Containerization Procedures. Return each sample bottle to its proper transport container.
16. If the sample bottles cannot be filled quickly, keep them cool with their caps on until they are filled. Each sample bottle for purgeable priority pollutant analysis should be filled from one bailer, then securely capped. NOTE: Samples must not be allowed to freeze.
17. Record the physical appearance of the ground water observed during sampling on the Ground-Water Sampling Field Log.
18. Replace the well plug and lock the well protection assembly before leaving the well location.
19. After sampling is completed, clean the pump by pumping deionized water through it. Rinse the outside of the pump and discharge tubing with clean water. Follow this with a methanol rinse, a hexane rinse, a second methanol rinse, and finally, a rinse with distilled water. The water and solvent rinses can be applied with

squeeze bottles and a clean towel.

20. Place gloves, rags, and plastic sheet into a plastic bag for disposal. Place the bailer in a plastic bag for delivery to a location where it can be properly cleaned.

ATTACHMENT A

SAMPLE CONTAINERIZATION PROCEDURES

Lab Analysis	Container Description	Number of Containers	Collection Instructions
Purgeable Priority	40 ml Vial	3	<ol style="list-style-type: none"><li data-bbox="984 562 1495 695">1. The sample vial consists of 3 parts: a glass bottle, a teflon-faced septum, and a screw cap.<li data-bbox="984 726 1495 825">2. Remove the cap and septum, handling the septum by the edges only.<li data-bbox="984 856 1495 955">3. Carefully fill the vial to overflowing, a slight crown of water remaining on top.<li data-bbox="984 987 1495 1085">4. Slide the septum, teflon side (slippery side) down, onto the vial.<li data-bbox="984 1117 1495 1148">5. Replace the cap and tighten.<li data-bbox="984 1180 1495 1509">6. Invert the sample and lightly tap the cap on a solid surface. The absence of trapped air indicates a successful seal. If bubbles are present, open the bottle, add a few additional drops of sample and reseal the bottle as above. Continue until no trapped air is present.<li data-bbox="984 1541 1495 1600">7. Keep the samples refrigerated or on ice.

GROUNDWATER SAMPLING FIELD LOG

Sample Location _____ Well No. _____

Sampled By: _____ Date _____ Time _____

Weather _____

A. Water Table

Well depth (from top of standpipe) (D) ____ . Well elevation (top of standpipe) _____

Depth to watertable (from top of standpipe) (W) ____ . Watertable elevation _____

Length of water column (LWC) _____ (feet). [(LWC) = (D) - (W)]

Volume of water in well - 2" diameter wells = 0.163 x (LWC) = _____ gallons

B. Physical Appearance At Start

Color _____ odor _____ turbidity _____

Was an oil film or layer apparent? _____

C. Preparation of Well for Sampling

Amount of water removed before sampling _____ gallons

Did well go dry? _____

D. Physical Appearance During Sampling

Color _____ odor _____ turbidity _____

Was an oil film or layer apparent? _____

E. Well Sampling

	<u>Analysis</u>	<u>Bottle No.</u>	<u>Special Sampling Instructions</u>
1.			
2.			
3.			
4.			
5.			
6.			
7.			
8.			
9.			
10.			

Soil Sampling Protocol

1. Divide the surface area of the potential "hot spot" into an imaginary grid. The grid spacing should be based on the number of samples required from the area, which when combined will give a statistically representative sample.
2. Obtain small, equal portions of surface or near-surface soil from each grid intersection.
3. Collect samples from the upper three inches of soil using a clean garden-variety trowl or laboratory scoop.
4. Composite the sample in a wide-mouth glass container with a foil-lined screw-type metal lid.
5. At the completion of sampling, cap and label the container. Record the appropriate sample information in the field-log book, and complete a chain-of-custody record.
6. When all samples have been collected, deliver them to the laboratory for analysis.

Surface Water Sampling Protocol

1. Assemble the pond sampler using a clean glass sampling beaker.
2. Dip the beaker into the water away from the immediate area of the sampling point and rinse it thoroughly.
3. To collect the sample, gently lower the beaker into the water and let it fill slowly to minimize agitation and aeration.
4. Remove the beaker and gently transfer the sample into two clean, pre-numbered 40-ml glass vials.
5. Fill the vials so that there is no head space after the cap is screwed down. The teflon septum should only be handled with clean disposable gloves.
6. Record the sample number on the sample log, field notebook, and on a 2 x 2 inch piece of paper with water-proof ink.
7. Place the bottles and a piece of paper in a "ziplock" bag and then in an iced chest.
8. After all samples are collected, fill out a laboratory chain-of-custody form and a laboratory instruction form. Lock the forms in the chest for delivery to a qualified laboratory, following chain-of-custody protocol.
9. Dismantle the sampler; store the clamp and handle in a plastic bag after wiping them with a clean towel.

Schedule of Implementation

<u>Task</u>	<u>Week(s)</u>
Hydrogeologic Setting	
Literature Review	1 - 2
Test Hole Drilling Ø 1	2 - 8 (2 rigs)
Geophysical Survey (optional)	5 - 8
Aquifer Characteristics	
Well Installation Ø 1	Included in test hole drilling
K-testing	6 - 9
Extent of GW Contamination	
Water Quality Sampling and Sample Analysis	10 - 13
Influence of Pumping Wells	
Records Review	3 - 4
Field Study	On-going from well installation to project completion, if necessary.
Soil Sampling	5 - 8
Surface Water Sampling	Every other week per plan for Immediate Corrective Action
Data Compilation and Evaluation	10 - 15
Report to EPA	17

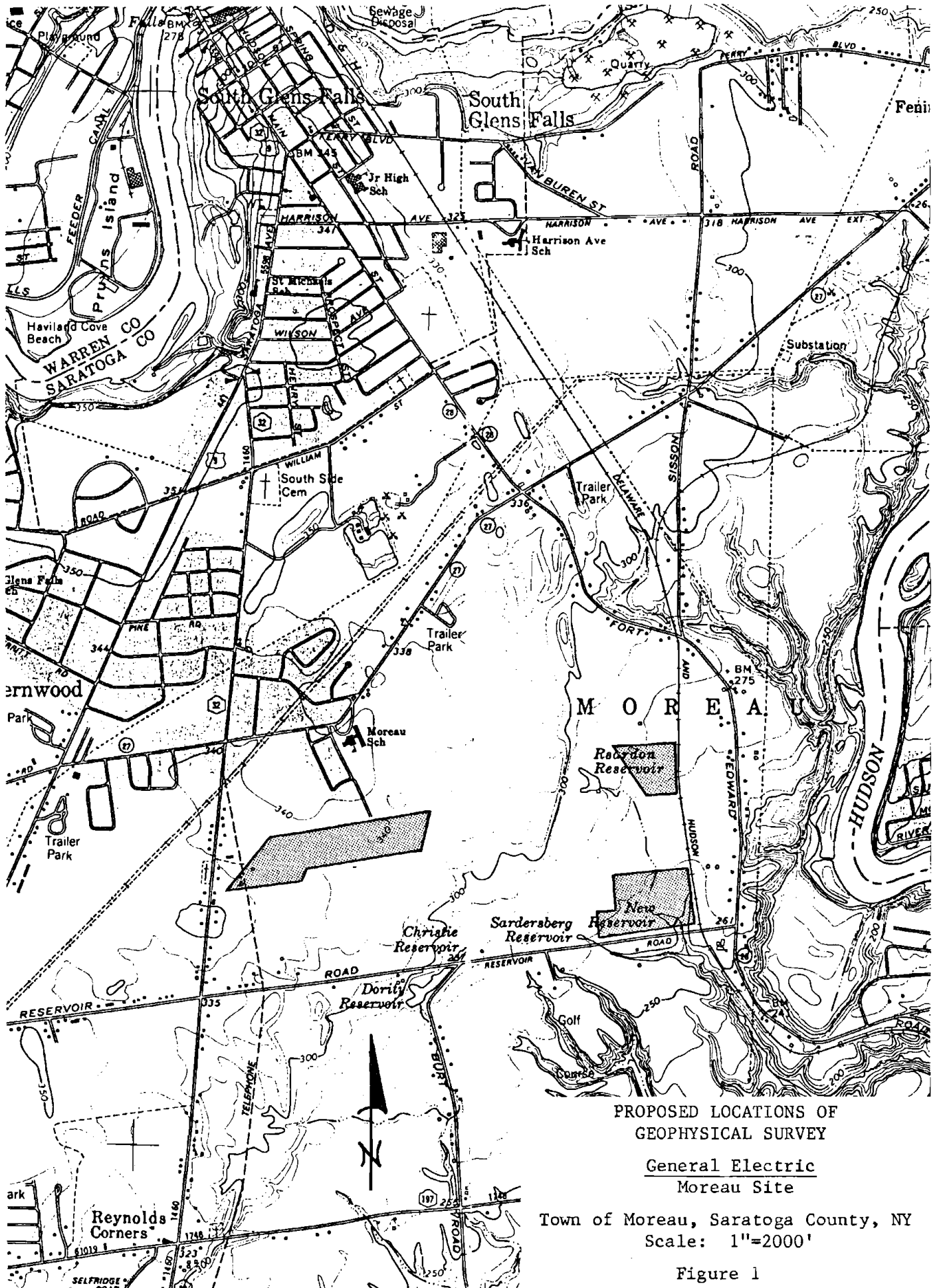

PROPOSED LOCATIONS OF
GEOPHYSICAL SURVEY

General Electric
Moreau Site

Town of Moreau, Saratoga County, NY
Scale: 1"=2000'

Figure 1

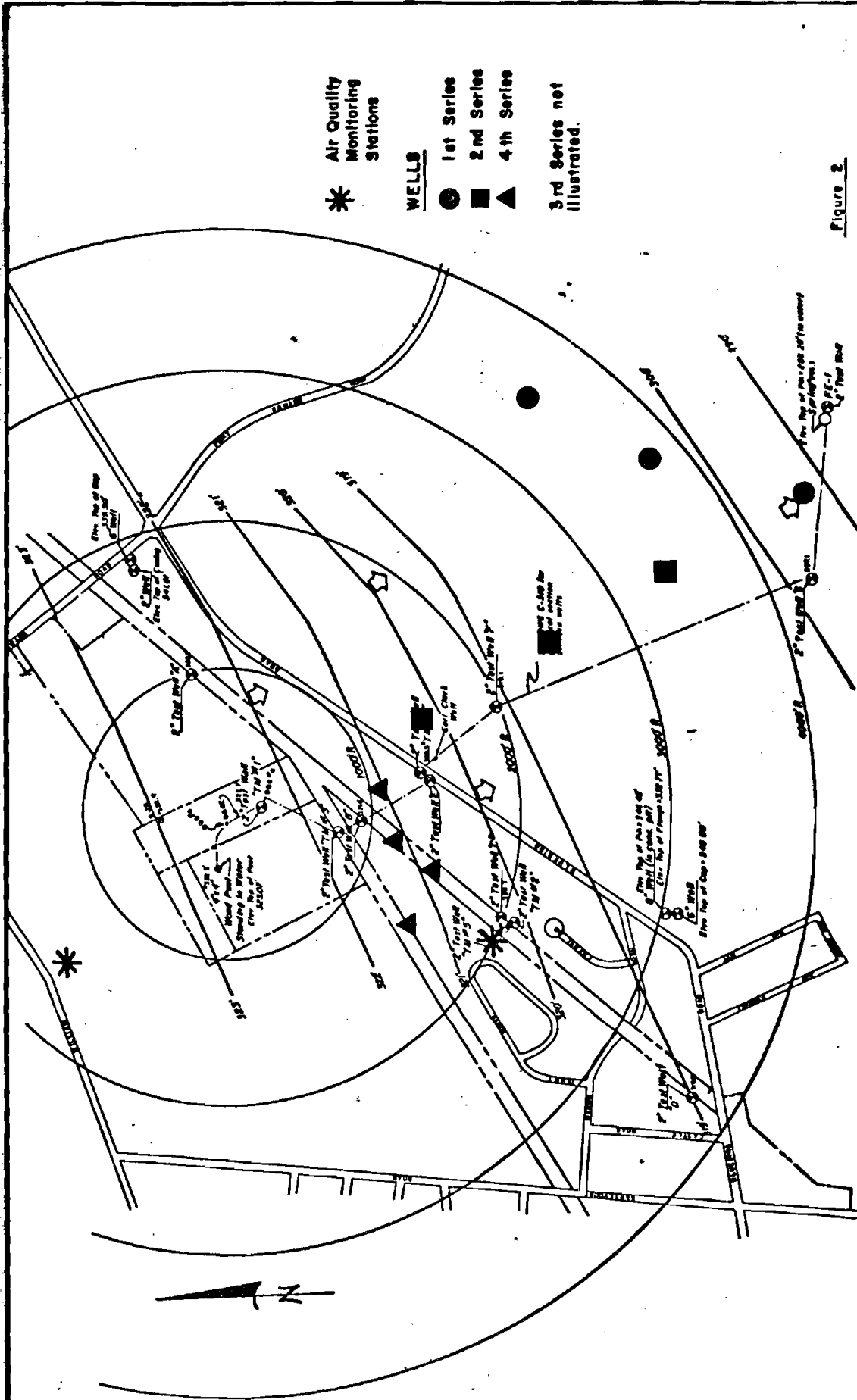

* Air Quality Monitoring Stations

WELLS

- 1st Series
- 2nd Series
- ▲ 4th Series

3rd Series not illustrated.

Figure 2

AIR QUALITY MONITORING STATIONS AND PROPOSED CLUSTER WELL LOCATIONS

GENERAL ELECTRIC
Moreau Site

Town of Moreau - Saratoga County, N.Y.

Scale: 1" = 400'

HEALTH AND SAFETY PLAN

A worker health and safety plan will be in effect throughout the remedial investigation. This plan will provide guidance to ensure worker protection from exposure to hazardous chemicals should such be encountered. Specific aspects of the health and safety plan include general safety protocol, required safety equipment and clothing, decontamination procedures, emergency response, and communications.

The remedial investigation will be conducted in downgradient areas away from the actual disposal facility. Consequently, it is anticipated that no significant contaminant levels will be encountered. Earlier investigations in the downgradient areas were performed at the Level D degree of protection. Therefore, Level D protection will also be instituted during the proposed remedial investigation.

However, since small potential dermal and respiratory hazards may exist in isolated areas, the level of protection will be upgraded to Level C respiratory protection if ambient organic vapor concentrations exceed 10 ppm. In addition, water and chemical resistant coveralls, gloves, and boots will also be required for Level C Protection.

Specific aspects of the plan are outlined below:

1. General Safety Requirements

- a. The immediate work area will be conspicuously marked.
- b. No food or drink may be consumed within the immediate work area.
- c. Smoking will not be permitted within the immediate work area.

2. Required Safety Equipment and Clothing

All persons involved in drilling or soil sample collection/handling will be required to wear certain safety equipment as follows:

a. Drilling

1. hard hats
2. coveralls
3. safety glasses

b. Soil Sampling/Drilling Supervision

1. items 1 through 3 above
2. disposable gloves

Respirators which have been properly fit-tested will also be available for all personnel. A portable organic vapor analyzer will also be available at the site to determine the presence of volatile organics.

3. Decontamination Procedures

- a. Gloves will be disposed of or decontaminated after sample contact.
- b. Safety suits will be stored with the drill rig and not removed from the immediate work area except for disposal.
- c. All auger flights, drill casing, drill rods and associated equipment used in the drilling of each soil boring will be steam-cleaned to remove all visible foreign matter prior to being used in the drilling of the next boring.

4. Emergency Information

The following information will be posted to be readily available to all on-site personnel.

- a. Location of nearest telephone or car radio.
- b. Local/plant fire department telephone number.
- c. Local/plant rescue department telephone number.
- d. Subcontractor offices (drillers, etc.) telephone number.
- e. Chemtrek telephone number.
- f. Project manager telephone number.

5. Emergency Rescue Equipment

The following equipment will be stored at the immediate work area:

- a. First aid kit.
- b. Oxygen kit.
- c. Burn kit.
- d. Rope.
- e. Blanket.

Schedule of Implementation

<u>Task</u>	<u>Duration (weeks)</u>
Waste Characterization	2
Hydrogeologic Setting	
Literature Review	2
Geophysical Survey	2 - 4
Test Hole Drilling Ø 1	8 (2 rigs)
Aquifer Characteristics	
Well Installation Ø 1	Included in test hole drilling
K-testing	2
Extent of GW Contamination	
Water Quality Sampling	2
Influence of Pumping Wells	
Records Review	2
Field Study	On-going from well installation to project completion, if necessary.

DTC
3/26/84

Sampling of Residential Wells
(Including Moreau School Wells)

<u>Schedule</u>	<u>Description</u>
Week 1 - 2	Organization and implementation of residential well plan: <ul style="list-style-type: none">- identify and contact residents to be sampled;- schedule adequate number of wells to initiate sampling;
Week 3 - 5	<ul style="list-style-type: none">- initiate sampling of wells;- deliver samples to laboratory according to chain-of-custody and security protocol.
Week 5 - 8	Water-quality data received from laboratory.
Week 6 - 8	Submit results to EPA.

DGC
3/26/84

PROTOCOL FOR
VOLATILE ORGANIC SCREENING OF
SPLIT-SPOON SAMPLES

1. Prepare a standard weight of the split-spoon sample and place it in a clean, tall, narrow, glass jar.
2. Seal the jar with metal foil and a screw cap. Label the cap with the sample identification number.
3. Warm the sample jar to a temperature of 40°C for 30 minutes.
4. Remove the screw cap, pierce the metal foil, and sample the headspace with the probe of an HNU portable organic vapor analyzer.
5. Record the sample number and the results of the analysis in the field notebook.
6. Recap the jar and store it securely for subsequent study, if necessary.

GROUND-WATER SAMPLING PROCEDURES

All wells will be exercised or thoroughly flushed of standing water in order that they contain fresh water from the aquifer before sampling begins. Because bailing can be very time-consuming when a large number of wells are involved, the wells will be exercised with a non-contaminating submersible pump. In all cases, the actual sample will be withdrawn using a teflon point-source bailer. The procedures are explained in detail below:

1. Identify the well and record the location on the Ground-Water Sampling Field Log.
2. Cut a slit in one side of a plastic sheet and slip it over and around the well creating a clean surface onto which the sampling equipment can be positioned. This clean working area should be a minimum of 10 feet by 10 feet. Do not kick, transfer, drop, or in any way let soils or other materials fall onto this sheet unless it comes from inside the well. Do not place meters, tools, equipment, etc., on the sheet unless they are clean and dry.
3. Put on a new pair of disposable gloves.
4. Clean the well cap with a clean rag and remove the well cap and plug, placing both on the plastic sheet.
5. Clean the first ten feet of a steel 100-foot tape. Rinse first with fresh water. Follow this with a methanol rinse, a hexane rinse, a second methanol rinse, and finally a rinse with distilled water. The water and solvent rinses can be applied with squeeze bottles. Measure the depth to the water table with the steel tape. Record this information on the Ground-Water Sampling Field Log (attached).
6. Compute the volume of water in the well using the formulae and information provided on the Ground-Water Sampling Field Log. Record

this volume on the field log.

7. Prepare the submersible pump for operation.
8. Lower the pump intake to the upper portion of the water column as far above the well screen as possible. (Shallow water-table wells are constructed so that the pump can only be set opposite the screened interval).
9. Start the pump and remove approximately one half quart of this water from the surface of the well water into a new glass quart bottle. Observe the appearance of this water. Return this quart bottle to its proper transport container. Note: This sample will not undergo laboratory analysis, and is collected to observe the physical appearance of the ground water only.
10. Record the physical appearance of the ground water on the Ground-Water Sampling Field Log.
11. Initiate pumping from the well into a graduated pail until four times the volume of water in the well has been removed or until the well is pumped dry. The pump should be lowered in the well until the final intake position is a few feet below the water level established in the well after drawdown reaches equilibrium.
12. If water being withdrawn becomes turbid during the exercising process or during sampling, terminate pumping or sampling until the well is redeveloped at a later time.
13. Remove the pump from the well, place it on the plastic sheet, and prepare to collect the sample with a dedicated teflon point-source bailer.
14. Remove the sampling bottles from their transport containers and prepare the bottles for receiving samples. Inspect all labels to insure proper sample identification. Sample bottles should be kept

cool with their caps on until they are ready to receive samples. Arrange the sampling containers to allow for convenient filling.

15. Initiate sampling by lowering the bailer slowly into the well to a depth opposite the midpoint of the screened interval. Remove the bailer in a smooth continuous manner to prevent the check valves from reopening and adulterating the sample. Minimize agitation of the water in the well. Fill each sample container following the instructions listed on Attachment A - Sample Containerization Procedures. Return each sample bottle to its proper transport container.
16. If the sample bottles cannot be filled quickly, keep them cool with their caps on until they are filled. Each sample bottle for purgeable priority pollutant analysis should be filled from one bailer, then securely capped. NOTE: Samples must not be allowed to freeze.
17. Record the physical appearance of the ground water observed during sampling on the Ground-Water Sampling Field Log.
18. Replace the well plug and lock the well protection assembly before leaving the well location.
19. After sampling is completed, clean the pump by pumping deionized water through it. Rinse the outside of the pump and discharge tubing with clean water. Follow this with a methanol rinse, a hexane rinse, a second methanol rinse, and finally, a rinse with distilled water. The water and solvent rinses can be applied with squeeze bottles and a clean towel.
20. Place gloves, rags, and plastic sheet into a plastic bag for disposal.

DEPTH FT.	CASING BLOWS	SAMPLE NUMBER	BLOWS ON SAMPLE SPOON PER 6"	UNIFIED CLASSI- FICATION	GRAPHIC LOG	IDENTIFICATION	REMARKS
68		S-35	8			Dr Gr fS, a ⁽⁺⁾ CyS; freq \$ +C \$ms	Rec=2.0' WET
			10				
			10				
			11				
70		S-36				same	Rec=1.0' WET 275 gals H ₂ O in 10 min pumped down hole
				9			
				15			
				19			
72			30			(running sand no samples possible)	
74						same	
76		S-37				Dr Gr \$+C; freq Cy\$ sms vvd. (glacio-lacustrine)	Rec=2.0' WET
				3			
				4			
				4			
78			6			Dark Gray SILT & CLAY; frequent Clayey Silt seams varved	
80							
82							
84							
86							Bentonite 78-71 Sand 71-60.0 Screen 68-63 Bentonite 60-57 Cement/Bentonite Grout 57.0-0

DUNN GEOSCIENCE CORPORATION LATHAM, NEW YORK (518) 783-8102				TEST BORING LOG			BORING NO. DGC-11	
PROJECT GE Moreau							SHEET 1 OF 1	
CLIENT GE Nott Street							JOB NO. 383-5-2973	
DRILLING CONTRACTOR Warren George, Inc.							ELEVATION 322.46'	
PURPOSE Monitoring Well Installation							DATE STARTED 5/17/84	
GROUNDWATER				CASING	SAMPLE	CORE	DATUM USGS	
DATE	TIME	DEPTH	CASING	TYPE	Mud Rot	SS	DATE FINISHED 5/18/84	
				DIAMETER	4 3/4"	2"	DRILLER R. Gregory	
				WEIGHT		140#	INSPECTOR J. Uruskyj	
				FALL		30"		

DEPTH FT.	CASING BLOWS	SAMPLE NUMBER	BLOWS ON SAMPLE SPOON PER 6"	UNIFIED CLASSIFICATION	GRAPHIC LOG	IDENTIFICATION	REMARKS
45		829	14	SW		No Recovery Br cmfS, tCy\$ <u>Brown coarse to fine SAND, trace Clayey Silt (SW)</u>	Rec. 1.6' WET
		S-1	15				
			18				
			20				
		829	5				
		S-2	8				
			16				
		836	17				
50							
55						End of Boring @ 53.1'	
						Bentonite 53.1 - 52.1	
						Sand Pack 52.1 - 42.0	
						Screen 50.0 - 45.0	
						Bentonite 42.0 - 36.9	
						Cement Grout 36.9 - 0.0	
						Protective Casing	
						Stick-Up 2.5'	

DUNN GEOSCIENCE CORPORATION LATHAM, NEW YORK (518) 783-8102				TEST BORING LOG			BORING NO. DGC-1S	
PROJECT GE Moreau							SHEET 1 OF 1	
CLIENT GE Nott Street							JOB NO. 383-5-2973	
DRILLING CONTRACTOR Warren George, Inc.							ELEVATION 322.60'	
PURPOSE Monitoring Well Installation							DATUM USGS	
GROUNDWATER				CASING	SAMPLE	CORE	DATE STARTED 5/18/84	
DATE	TIME	DEPTH	CASING	TYPE	Mud Rot	SS	DATE FINISHED 5/18/84	
				DIAMETER	4 3/4"	2"	DRILLER R. Gregory	
				WEIGHT		140#	INSPECTOR M. Ianniello	
				FALL		30"		

DEPTH FT.	CASING BLOWS	SAMPLE NUMBER	BLOWS ON SAMPLE SPOON PER 6"	UNIFIED CLASSIFICATION	GRAPHIC LOG	IDENTIFICATION	REMARKS
25							
		S-1	11			BrGr cmfS, t(+)\$	Rec. .9' WET
		810	15	SW			
			20				
			18				
		S-2	18			BrGr cmfS, t(+)\$, occ Cy\$ seams	Rec. 2.0' WET
30		805	26	SW		<u>Brown-Gray coarse to fine SAND,</u> <u>trace(+) Silt; occasional Silt</u> <u>seams (SW)</u>	
			29				
			32				
35						Grout 15 - 0	
						Bentonite 20 - 15	
						Screen 22 - 32	
						Sand 34 - 20	
						Bentonite 34 - 35	

DUNN GEOSCIENCE CORPORATION LATHAM, NEW YORK (518) 783-8102	TEST BORING LOG	BORING NO. DGC - 2
---	------------------------	------------------------------

PROJECT G.E./Moreau

CLIENT G.E. Nott St. SHEET 1 OF 4

DRILLING CONTRACTOR Warren George Inc. JOB NO. 383-5-2973

PURPOSE Subsurface Geologic Invest./Monitoring Well Install. ELEVATION 315.44'

GROUNDWATER CASING SAMPLE CORE DATUM USGS

DATE TIME DEPTH CASING TYPE Mud Rot SS DATE STARTED 5/8/84

DIAMETER 4 3/4 2" DATE FINISHED 5/9/84

WEIGHT 140# DRILLER R. Gregory

FALL 30" INSPECTOR M. Ianniello

DEPTH FT.	CASING BLOWS	SAMPLE NUMBER	BLOWS ON SAMPLE SPOON PER 6"	UNIFIED CLASSIFICATION	GRAPHIC LOG	IDENTIFICATION	REMARKS		
5		S-1	2	SW		Bk cmfS, t Organic \$	Rec=1.4' Dry		
			1						
			2						
			3						
		S-2	5	SW				Br cmfS, t ⁽⁺⁾ \$; rts	Rec=1.5' Dry
			6						
			11						
		S-3	7	SW				Br cmfS, t ⁽⁺⁾ \$; occ dk S lysrs	Rec=1.6' Dry
			8						
			11						
10		S-4	13	SW	Brown coarse to fine SAND, trace Silt; frequent black Silt layers (SW).	Rec=.8' Dry			
			14						
		S-5	14	SW	same	Rec=1.1' Dry-damp			
			8						
15		S-6	12	SW	Br cmfS, t\$, occ mfs, l\$ seams (glacio-fluvial deltaic)	Rec=1.0' Damp-moist			
			10						
			12						
			14						
		S-7	9	SW	Br cmfS, t ⁽⁺⁾ \$, freq mfs, l ⁽⁺⁾ \$lyrs	Rec=1.0' Moist			
			10						
			12						
			14						
20		S-8	10	SW	Br cmfS, t ⁽⁺⁾ \$, freq bk S lysrs, freq br mfs, l ⁽⁺⁾ \$ lysrs	Rec=.9' Moist			
			16						
		S-9	18	SW	Br mfs, l\$; freq bk cmfS, t\$ lysrs	Rec=.8' Moist-WET			
			15						
	S-10	12	SW	Br mfs, l\$; freq bk cmfS, t\$ lysrs	Rec=.8' WET				
		17							
		18							

DEPTH FT.	CASING BLOWS	SAMPLE NUMBER	BLOWS ON SAMPLE SPOON PER 6"	UNIFIED CLASSIFICATION	GRAPHIC LOG	IDENTIFICATION	REMARKS
20		S-11	10	SW		Br c ⁽⁻⁾ mfS, 1 ⁽⁺⁾ Cy\$; thin \$&C lyr ¼"	Rec=1.3' WET
			11				
			10				
			10				
		S-12	5	SW		Br c ⁽⁻⁾ mfS, 1 ⁽⁺⁾ Cy\$; occ thin \$&C lyr	Rec=.7' WET
			7				
			10				
			5				
25		S-13	3	SW		Br \$&C; freq Cy\$ seams; vvd	Rec=1.3' WET soft
			3				
			6				
			9				
		S-14	11	SW		Br cmfS, t ⁽⁺⁾ \$; freq bk cmfS seams	Rec=1.0' WET
			17				
			17				
			18				
		S-15	10	SW		Br cmfS, t ⁽⁺⁾ \$ Lt br mfS, 1 ⁽⁺⁾ Cy\$	Rec=1.5' WET
			14				
			15				
			18				
30		S-16	5	SW		Br cmfS, t ⁽⁺⁾ \$ Br cmfS, t ⁽⁺⁾ \$ <u>Brown coarse to fine SAND, trace(+)</u> <u>Silt (SW).</u>	Rec=1.3' WET
			11				
			14				
			18				
		S-17	17	SW		same (Deltaic)	Rec=1.0' WET
			21				
			24				
			26				
35		S-18	15	SW		Br cmfS, t ⁽⁺⁾ \$	Rec=2.0' WET
			15				
			18				
			26				
		S-19	28	SW		Br cmfS, t ⁽⁺⁾ \$	Rec 2.0' WET
			38				
			30				
			40				
		S-20	21	SW		Br cmfS, t\$; occ Bk Rd seam	Rec=1.05' WET
			32				
			38				
			45				
40		S-21	14	SW		Br cmfS, t ⁽⁺⁾ \$	REC=1.1' WET
			12				
			13				
			14				
		S-22	4	SW		Br cmfS, t\$; freq Rd Bk cmfS, t\$ lyrs ½' thk	Rec=.9' WET
			6				
			7				
			10				
			6				
			9				

DUNN GEOSCIENCE CORPORATION LATHAM, NEW YORK (518) 783-8102	TEST BORING LOG	BORING NO. DGC-2
---	------------------------	-------------------------

PROJECT G.E./Moreau	SHEET 3 OF 4
----------------------------	---------------------

CLIENT G.E. Nott St.	JOB NO. 383-5-2973
-----------------------------	---------------------------

DEPTH FT.	CASING BLOWS	SAMPLE NUMBER	BLOWS ON SAMPLE SPOON PER 6"	UNIFIED CLASSIFICATION	GRAPHIC LOG	IDENTIFICATION	REMARKS
45		S-23	17	SW		Br cmfS, t ⁽⁺⁾ Cy\$	Rec=1.6' WET
			15				
			8				
		S-24	11				
	12		SW				
			12				
		S-25	14	SW	Br cmfS, t ⁽⁺⁾ Cy\$ (Deltaic)	Rec=1.5' WET	
			14				
			16				
			18				
50		S-26	4	SW	Br cmfS, t ⁽⁺⁾ Cy\$; occ br id cmfS lyrs.	Rec=1.1' WET	
			10				
			12				
			15				
		S-27	12	SW	Br cmfS, t\$	Rec=2.0' WET	
			14				
			16				
			17				
55		S-28	14	SW	Tn br cmfS, t ⁽⁺⁾ \$; occ lyrs tn br Cy\$	Rec=1.2' WET	
							14
							17
							14
		S-29	5	SW	Br cmfS, t ⁽⁺⁾ \$; freq lyr mfS, 1Cy\$	Rec=1.1' WET	
			10				
			18				
			21				
		S-30	14	SW	Br cmfS, t ⁽⁺⁾ \$ Tnbr mfS, 1 ⁽⁺⁾ Cy\$; occ dk gr \$ & C sms 1/4"	Rec=1.1' WET	
			14				
			16				
			18				
60		S-31	12	SW	Br cmfS, t\$ Tn br mfS; sCy\$; freq lyrs tn br Cy\$, occ lyr\$&C	Rec=1.2' WET	
							14
							17
							19
		S-32	11	SM	Tn br mfS; sCy\$; occ lyrs cmfS, 1 Cy\$ occ seams; dk gr \$&C	Rec=1.1' WET	
			11				
			14				
			14				
65		S-33	5	SP	Tnbr mfS, 1Cy\$	Rec=1.2' WET	
							11
							11
							18
		S-34	11	SM	Tnbr cmfS s, ⁽⁺⁾ Cy\$; freq lyrs gr \$&C	Rec=1.1' WET	
			10				
			12				
			14				
		S-35	12	SM	Grbr Cy\$, sf\$; freq lyrs gr C&C Gr mfs, s ⁽⁻⁾ Cy\$; freq lyrs gr C&\$ (transistional glacio-lacustrine)	Rec=1.2' WET	
			12				
			15				

DUNN GEOSCIENCE CORPORATION
 LATHAM, NEW YORK (518) 783-8102

TEST BORING LOG

BORING NO. DGC-2

PROJECT G.E./Moreau

SHEET 4 OF 4

CLIENT G.E. Nott St.

JOB NO. 383-5-2973

DEPTH FT.	CASING BLOWS	SAMPLE NUMBER	BLOWS ON SAMPLE SPOON PER 6"	UNIFIED CLASSI- FICATION	GRAPHIC LOG	IDENTIFICATION	REMARKS
70		S-36	3	ML		Tn gr \$a, fS; Gr C&\$ lyr Tan gray Silt and fine SAND; gray Clay and Silt layer 70.8'-71.3' (ML)	Rec=1.2' WET
			14				
			21				
			29				
		S-37	6	CL		Gr C&\$; Gr\$ s, fS lyr 4" (Transistional glacio-lacustrine) 74.0'	Rec=1.1' WET
			14				
		S-38	21	CL	Gr C&\$; freq \$&C sms, vvd. Gray CLAY & SILT: frequent SILT & CLAY seams varved (CL).	Rec=2.0' WET	
			24				
			8				
75		S-38	3	CL	Gr C&\$; freq \$&C sms, vvd. (glacio-lacustrine) 78.0'	Rec=2.0' WET	
			8				
		S-39	10	CL			
			11				
		10					
80							

End of Boring @ 76.0'

Bentonite	76 - 68
Sand	68 - 58
Screen	65.5-60.5
Bentonite	58 - 53
Grout	53 - 0

DUNN GEOSCIENCE CORPORATION LATHAM, NEW YORK (518) 783-8102	TEST BORING LOG	BORING NO. DGC-2I
---	------------------------	-----------------------------

PROJECT GE Moreau	SHEET 1 OF 1
--------------------------	---------------------

CLIENT GE Nott Street	JOB NO. 383-5-2973
------------------------------	---------------------------

DRILLING CONTRACTOR Warren George, Inc.	ELEVATION 315.39'
--	--------------------------

PURPOSE Monitoring Well Installation	DATUM USGS
---	-------------------

GROUNDWATER				CASING	SAMPLE	CORE	DATE STARTED
DATE	TIME	DEPTH	CASING	TYPE	Mud Rot	SS	5/15/84
				DIAMETER	4 3/4"	2"	DATE FINISHED 5/15/84
				WEIGHT		140#	DRILLER Victor Aimar
				FALL		30"	INSPECTOR J. Uruskyj

DEPTH FT.	CASING BLOWS	SAMPLE NUMBER	BLOWS ON SAMPLE SPOON PER 6"	UNIFIED CLASSIFICATION	GRAPHIC LOG	IDENTIFICATION	REMARKS
40							
		S-1	7				
			11				
			15				
			14				
		S-2	3				
45			5	SW		Br cmfS, tCy\$	No Recovery
			10			<u>Brown coarse to fine SAND,</u>	Rec. .7'
			13			<u>trace Clayey Silt (SW)</u>	WET
						End of Boring @ 49.0'	
50						Well Installation	
						Bentonite 49.0 - 48.0	
						Sand Pack 48.0 - 38.0	
						Screen 46.0 - 41.0	
						Bentonite 38.0 - 33.0	
						Grout 33.0 - 0.0	
						Protective Casing	
						Stick-Up 2.5'	

DUNN GEOSCIENCE CORPORATION LATHAM, NEW YORK (518) 783-8102				TEST BORING LOG			BORING NO. DGC-2S	
PROJECT GE Moreau							SHEET 1 OF 1	
CLIENT GE Nott Street							JOB NO. 383-5-2973	
DRILLING CONTRACTOR Warren George, Inc.							ELEVATION 315.16'	
PURPOSE Monitoring Well Installation							DATE STARTED 5/16/84	
GROUNDWATER					CASING	SAMPLE	CORE	DATUM USGS
DATE	TIME	DEPTH	CASING	TYPE	Mud Rot	SS		DATE FINISHED 5/17/84
				DIAMETER	4 3/4"	2"		DRILLER Victor Aimar
				WEIGHT		140#		INSPECTOR J. Uruskyj
				FALL		30"		
DEPTH FT.	CASING BLOWS	SAMPLE NUMBER	BLOWS ON SAMPLE SPOON PER 6"	UNIFIED CLASSIFICATION	GRAPHIC LOG	IDENTIFICATION		REMARKS
25		S-1 826	9 15 11 24	ML		GrBr \$&C; vvd., freq. prt gr \$ 24.6'		Rec. 1.7' WET
30						Brown coarse to fine SAND, trace Silt (ML)		
35						End of Boring @ 31.0'		
						Bentonite	31.0 - 30.0	
						Sand	30.0 - 15.5	
						Screen	27.5 - 17.5	
						Bentonite	15.5 - 10.5	
						Cement Grout	10.5 - 0.0	
						Protective Casing Stick-Up	2.5'	

DUNN GEOSCIENCE CORPORATION LATHAM, NEW YORK (518) 783-8102				TEST BORING LOG		BORING NO. DGC-3	
--	--	--	--	-----------------	--	---------------------	--

PROJECT G.E./Moreau						SHEET 1 OF 3	
---------------------	--	--	--	--	--	--------------	--

CLIENT G.E. Nott St.						JOB NO. 383-5-2973	
----------------------	--	--	--	--	--	--------------------	--

DRILLING CONTRACTOR Warren George Inc.						ELEVATION 316.70'	
--	--	--	--	--	--	-------------------	--

PURPOSE Subsurface Geologic Invest./Monitoring Well Install.						DATE STARTED 5/10/84	
--	--	--	--	--	--	----------------------	--

GROUNDWATER				CASING	SAMPLE	CORE	DATE FINISHED 5/11/84
-------------	--	--	--	--------	--------	------	-----------------------

DATE	TIME	DEPTH	CASING	TYPE	Mud Rot	SS	DRILLER R. Gregory
------	------	-------	--------	------	---------	----	--------------------

				DIAMETER	4 3/4"	2"	INSPECTOR M. Ianniello
--	--	--	--	----------	--------	----	------------------------

				WEIGHT		140#	
--	--	--	--	--------	--	------	--

				FALL		30"	
--	--	--	--	------	--	-----	--

DEPTH FT.	CASING BLOWS	SAMPLE NUMBER	BLOWS ON SAMPLE SPOON PER 6"	UNIFIED CLASSIFICATION	GRAPHIC LOG	IDENTIFICATION	REMARKS
5		S-1	4	OL		DK Br organic \$a; fS; rts .9'	Rec=1.7' Damp
			2	SW			
			3				
			4				
5		S-2	5	SW	Br cmfS, t\$ (Deltaic)	Rec=1.4' Damp	
			7				
			8				
			7				
10		S-3	5	SW	Br cmfS, t\$; occ Rd Br S seam	Rec=1.2' Damp	
			7				
			6				
			8				
15		S-4	7	SW	Br cmfS, t \$	Rec=1.1' Damp	
			11				
			10				
			14				
20							

DUNN GEOSCIENCE CORPORATION
LATHAM, NEW YORK (518) 783-8102

TEST BORING LOG

BORING NO. DGC-3

PROJECT G.E./Moreau

SHEET 2 OF 3

CLIENT G.E. Nott St.

JOB NO. 383-5-2973

DEPTH FT.	CASING BLOWS	SAMPLE NUMBER	BLOWS ON SAMPLE SPOON PER 6"	UNIFIED CLASSIFICATION	GRAPHIC LOG	IDENTIFICATION	REMARKS
20		S-5	11	SW		Br cmfS, t\$; occ Rd Bk S seams	Rec=1.1' Damp
			14				
			15				
			15				
25		S-6	15	SW		Br cmfS, t\$	Rec=1.4' WET
			20				
			22				
			27				
30		S-7	10	SW		Br cmfS, t ⁽⁻⁾ cy\$	Rec=1.2' WET
			12				
			16				
			16				
35		S-8	12	SW		Br cmfS, t \$	Rec=.95' WET
			12				
			11				
			12				
40		S-9	10	SW		Br cmfS, t\$; occ Rd Bk S seams	Rec=1.3' WET
			9				
			11				
			12				

Brown coarse to fine Sand, trace Silt; occasional red-black Sand seams (SW).

(Deltaic)

DUNN GEOSCIENCE CORPORATION LATHAM, NEW YORK (518) 783-8102	TEST BORING LOG	BORING NO. DGC-3
---	------------------------	-------------------------

PROJECT G.E./Moreau	SHEET 3 OF 3
----------------------------	---------------------

CLIENT G.E. Nott St.	JOB NO. 383-5-2973
-----------------------------	---------------------------

DEPTH FT.	CASING BLOWS	SAMPLE NUMBER	BLOWS ON SAMPLE SPOON PER 6"	UNIFIED CLASSIFICATION	GRAPHIC LOG	IDENTIFICATION	REMARKS
45		S-10	12 11 11 12	SW		Br cmfS, tCy\$ <u>Brown coarse to fine Sand, trace Clayey-Silt, (SW).</u>	Rec=1.1' WET
50		S-11	12 11 11 11	SW		Br cmfS, t Cy\$ Br\$&C seam at 51.2' (Deltaic)	Rec=1.1' WET
55		S-12	14 9 14 17	ML		Gr br Cy\$a ⁽⁺⁾ , fS; freq lyrs Gr \$&C	Rec=1.2' WET
		S-13	7 7 11 13	SM		Gr f S, a Cy\$; freq dk Gr lyr \$&C Gr-br fSlyr @ 58 (transitional glacio-lacustrine)	Rec=1.9' WET
60		S-14	17 17 23 28	ML		Gr Cy\$t, fS; freq dk Gr seams \$&C <u>Gray Clayey Silt trace, fine Sand; frequent dark Gray Silt & Clay seams (ML).</u>	Rec=1.4' WET
65			6 9 10 12	CL		Gr C&\$; vvd. (glacio-lacustrine) 67.0' End of Boring	Rec=1.9' WET
						Grout 43.0 - 0.0 Bentonite 45.0 -43.0 Screen 53.0 -48.0 Sand 55.0 -45.0	

DUNN GEOSCIENCE CORPORATION LATHAM, NEW YORK (518) 783-8102					TEST BORING LOG			BORING NO. DGC-3I	
PROJECT GE Moreau								SHEET 1 OF 1	
CLIENT GE Nott Street								JOB NO. 383-5-2973	
DRILLING CONTRACTOR Warren George, Inc.								ELEVATION 316.98'	
PURPOSE Monitoring Well Installation								DATE STARTED 5/15/84	
GROUNDWATER					CASING	SAMPLE	CORE	DATUM USGS	
DATE	TIME	DEPTH	CASING	TYPE	Mud Rot	SS		DATE FINISHED 5/15/84	
				DIAMETER	4 3/4"	2"		DRILLER R. Gregory	
				WEIGHT		140#		INSPECTOR M. Ianniello	
				FALL		30"			

DEPTH FT.	CASING BLOWS	SAMPLE NUMBER	BLOWS ON SAMPLE SPOON PER 6"	UNIFIED CLASSIFICATION	GRAPHIC LOG	IDENTIFICATION	REMARKS
40		S-1	9 15 21 27	SW	821	No Sample	Rec. 0
		S-2	7 12			Soil Sample	
		821	16 16			Br cmfS, t\$	Rec. 1.0' WET
45						Stick-Up	
50						Grout 32 - 0 Bentonite 37 - 32 Sand 37 - 50 Screen 42 - 47 Bentonite 50	

DUNN GEOSCIENCE CORPORATION LATHAM, NEW YORK (518) 783-8102					TEST BORING LOG			BORING NO. DGC-3S	
PROJECT GE Moreau								SHEET 1 OF 1	
CLIENT GE Nott Street								JOB NO. 383-5-2973	
DRILLING CONTRACTOR Warren George, Inc.								ELEVATION 317.74'	
PURPOSE Monitoring Well Installation									
GROUNDWATER					CASING	SAMPLE	CORE	DATUM USGS	
DATE	TIME	DEPTH	CASING	TYPE	Mud Rot	SS		DATE STARTED 5/16/84	
				DIAMETER	4 3/4"	2"		DATE FINISHED 5/16/84	
				WEIGHT		140#		DRILLER R. Gregory	
				FALL		30"		INSPECTOR M. Ianniello	

DEPTH FT.	CASING BLOWS	SAMPLE NUMBER	BLOWS ON SAMPLE SPOON PER 6"	UNIFIED CLASSI- FICATION	GRAPHIC LOG	IDENTIFICATION	REMARKS
25							
		S-1	2			Br cmfS, t(+)\$	Rec. 1.1' WET
		837A	5	SW			
			23				
			31				
		S-2	15			Br cmfS; t(+)\$	Rec. 2.0' WET
		832B	29	SW		<u>Brown coarse to fine SAND,</u> <u>trace(+) Silt (SW)</u>	
			30				
			29				
30							
						Cement/Bentonite Grout	0 - 11
						Bentonite	16 - 11
						Screen	29 - 19
						Sand	32 - 16
						Bentonite	33 - 32
35							

DUNN GEOSCIENCE CORPORATION LATHAM, NEW YORK (518) 783-8102				TEST BORING LOG		BORING NO. DGC-4	
---	--	--	--	------------------------	--	----------------------------	--

PROJECT GE Moreau

CLIENT GE Nott Street SHEET 1 OF 3

DRILLING CONTRACTOR Warren George, Inc. JOB NO. 383-5-2973

PURPOSE Subsurface Geologic Invest./Monitoring Well Install. ELEVATION 303.25'

GROUNDWATER CASING SAMPLE CORE DATUM USGS

DATE TIME DEPTH CASING TYPE Mud Rot. SS DATE STARTED 5/17/84

DIAMETER 4 3/4" 2" DATE FINISHED 5/17/84

WEIGHT 140# DRILLER Victor Aimar

FALL 30" INSPECTOR M.L. Ianniello

DEPTH FT.	CASING BLOWS	SAMPLE NUMBER	BLOWS ON SAMPLE SPOON PER 6"	UNIFIED CLASSIFICATION	GRAPHIC LOG	IDENTIFICATION	REMARKS
		S-1	1	SM		DkBr cmfS, s organic \$ 1, rts .3 Br Same	Rec. 1.1' Dry
			2				
			2				
			2				
5		S-2	4	SW		Br cmfS, t(+) \$ (Deltaic)	Rec. 1.0' Moist
			4				
			7				
			8				
10		S-3	6	SM		Br cmfS, s \$; occ Dk S seams 10.8' TnBr \$s, fS; freq S&C seams vvd. (Glacio-lacustrine)	Rec. 1.55 Moist
			5				
			4				
			8				
15		S-4	3	ML		DkGr \$&Cs, fS; vvd freq 16.0' Tn Same	Rec. 2.0'
			2				
			1				
			6				
20							~19.0'

DUNN GEOSCIENCE CORPORATION LATHAM, NEW YORK (518) 783-8102	TEST BORING LOG	BORING NO. DGC-4
---	------------------------	-------------------------

PROJECT GE Moreau	SHEET 2 OF 3
--------------------------	---------------------

CLIENT GE Nott Street	JOB NO. 383-5-2973
------------------------------	---------------------------

DEPTH FT.	CASING BLOWS	SAMPLE NUMBER	BLOWS ON SAMPLE SPOON PER 6"	UNIFIED CLASSIFICATION	GRAPHIC LOG	IDENTIFICATION	REMARKS
20		S-5	6	SW		Br cmfS, t\$ (Deltaic)	Rec. 1.4' WET
			10				
			9				
			9				
25		S-6 816	6	SW		Br cmfS, t\$	Rec. 1.0' WET
			10				
			12				
			12				
30		S-7 802	10	SW		Br cmfS, t\$	Rec. 1.3' WET
			11				
			12				
			15				
35		S-8 822	9	SW		Br cmfS, t(+)\$	Rec. 0.6' WET
			11				
			12				
			12				
40		S-9 801	5	SW		Br cmfS, t(+)\$	Rec. 1.0' WET
			5				
			6				
			8				
		S-10 824	5	SW		Same	Rec. 0.9' WET
			6				
			13				
			15				
			10				

DUNN GEOSCIENCE CORPORATION LATHAM, NEW YORK (518) 783-8102	TEST BORING LOG	BORING NO. DGC-4
---	------------------------	-------------------------

PROJECT GE Moreau	SHEET 3 OF 3
--------------------------	---------------------

CLIENT GE Nott Street	JOB NO. 383-5-2973
------------------------------	---------------------------

DEPTH FT.	CASING BLOWS	SAMPLE NUMBER	BLOWS ON SAMPLE SPOON PER 6"	UNIFIED CLASSIFICATION	GRAPHIC LOG	IDENTIFICATION	REMARKS
45	834	S-11	13	ML		Gr Cy\$ 1, fS, freq C&\$, vvd	Rec. 1.8' Moist
			16				
50		S-12 818	2	ML		Gr \$s, fS; freq C&\$ lyrs, vvd	Rec. 1.5' WET
			6				
			9				
			14				
50		S-13 817	8	ML		Gr \$1(-) fS; freq C&\$ lyrs, vvd	Rec. 1.9' WET
			8				
			11				
			13				
50		S-14 831	5	ML		Same	Rec. 1.4' WET
			11				
			13				
			12				
55		S-15 823	1	ML		Gr Cy\$ 1(-), fS; freq C&\$ lyrs	Rec. 2.0' Moist
			1				
			3				
			5				
60		S-16 809	WR	ML		Gr C&\$; freq \$&C lyrs	Rec. 2.0' WET
			WR				
			WR				
			2				
65						Cement/Bentonite Grout	30
	Bentonite	33 - 30					
	Screen	44 - 35					
	Sand	46 - 33					
	Bentonite	62.0-46					

54.0

(Glacio-lacustrine)

DUNN GEOSCIENCE CORPORATION LATHAM, NEW YORK (518) 783-8102	TEST BORING LOG	BORING NO. DGC-4I
---	------------------------	-----------------------------

PROJECT GE Moreau

CLIENT GE Nott

DRILLING CONTRACTOR Warren George

PURPOSE Well Cluster Installation

GROUNDWATER CASING SAMPLE CORE DATUM MSL

DATE TIME DEPTH CASING TYPE Flush SS DATE STARTED 5/18/84

DIAMETER 4" 2" DATE FINISHED

WEIGHT 300# 140# DRILLER Victor Aimar

FALL 18" 30" INSPECTOR J. Wink

DEPTH FT.	CASING BLOWS	SAMPLE NUMBER	BLOWS ON SAMPLE SPOON PER 6"	UNIFIED CLASSIFICATION	GRAPHIC LOG	IDENTIFICATION	REMARKS
30		S-1		SW		In cmfS, t\$	Tri-cone & Wash [0.0' - 27']
			15				
			18				
			22				
35		S-2		SW		Same; occ \$&C prt, vvd	Rec. 0.1' WET
			15				
			19				
			32				
						<u>Tan coarse to fine SAND, trace Silt; occasional Silt & Clay partings, varved (SW)</u>	
						Grout	0 - 24
						Bentonite	27 - 24
						Screen	29 - 35
						Sand	37 - 27
						Bentonite	38 - 32

DUNN GEOSCIENCE CORPORATION				TEST BORING LOG				BORING NO.						
LATHAM, NEW YORK (518) 783-8102								DGC-4S						
PROJECT								GE Moreau						
CLIENT								GE Nott Street						
DRILLING CONTRACTOR								Warren George						
PURPOSE								Monitoring Well Installation						
GROUNDWATER								CASING	SAMPLE	CORE	DATUM		USGS	
DATE	TIME	DEPTH	CASING	TYPE		Mud Rot. SS		DATE STARTED		5/21/84				
				DIAMETER		4 3/4" 2"		DATE FINISHED		5/22/84		Aimar		
				WEIGHT		140#		DRILLER		Victor Aimar				
				FALL		30"		INSPECTOR		J. Uruskyj				

DEPTH FT.	CASING BLOWS	SAMPLE NUMBER	BLOWS ON SAMPLE SPOON PER 6"	UNIFIED CLASSIFICATION	GRAPHIC LOG	IDENTIFICATION	REMARKS
5							
		S-1	8	ML		Br Cy\$; occ C&S seams	12.5'
			7		Gr \$&C; vvd		
			7		Gray SILT & CLAY; varved		
			5				
15						Well Installation	
						Depth of Boring	32.0'
						Bentonite	32.0' - 31.0'
						Sand Pack	31.0' - 6.0'
						Screen	29.0' - 8.0'
						Bentonite	6.0' - 2.0'
						Cement	2.0' - 0.0'
						Stickup	2.5'
20						Protective Casing	

C&S

DUNN GEOSCIENCE CORPORATION LATHAM, NEW YORK (518) 783-8102				TEST BORING LOG		BORING NO. DGC-5	
PROJECT GE Moreau						SHEET 1 OF 4	
CLIENT GE Nott Street						JOB NO. 383-5-2973	
DRILLING CONTRACTOR Warren George						ELEVATION 327.01'	
PURPOSE Subsurface Geologic Investigation/Monitoring Well						GROUNDWATER	
				CASING	SAMPLE	CORE	DATUM USGS
DATE	TIME	DEPTH	CASING	TYPE	Mud Rot.	SS	DATE STARTED 5/21/84
				DIAMETER	4 3/4"	2"	DATE FINISHED 5/22/84
				WEIGHT		140#	DRILLER R. Gregory
				FALL		30"	INSPECTOR M. Ianniello

DEPTH FT.	CASING BLOWS	SAMPLE NUMBER	BLOWS ON SAMPLE SPOON PER 6"	UNIFIED CLASSIFICATION	GRAPHIC LOG	IDENTIFICATION	REMARKS
		S-1	1	SM		DrBr cmfS, a organic \$; rts .5' BrOr cmfS 1, organic \$ (Glacio-lacustrine)	Rec. 1.5' Dry
			2				
			2				
			2				
5		S-2	5	SW		Br cmfS, t(+) \$ <u>Brown coarse to fine SAND, trace Silt (SW)</u>	Rec. 1.1' Dry
			7				
			11				
			7				
10		S-3	5	SW		Br cmfS, t(+) \$; occ Cy\$ seams; occ dkbr S lyrs	Rec. 1.1' Moist
			5				
			7				
			10				
15		S-4	7	SW		Br cmfS, t\$	Rec. 1.0' Moist
			9				
			13				
			13				

DUNN GEOSCIENCE CORPORATION
LATHAM, NEW YORK (518) 783-8102

TEST BORING LOG

BORING NO. DGC-5

PROJECT GE Moreau

SHEET 2 OF 4

CLIENT GE Nott Street

JOB NO. 383-5-2973

DEPTH FT.	CASING BLOWS	SAMPLE NUMBER	BLOWS ON SAMPLE SPOON PER 6"	UNIFIED CLASSIFICATION	GRAPHIC LOG	IDENTIFICATION	REMARKS
25		S-5	8	SW		Br cmfS, t\$	Rec. 1.0' Moist
			8				
			16				
			13				
30		S-6 808	11	SW		Br cmfS, t(-)\$ <u>Brown coarse to fine SAND, trace(-)</u> <u>Silt (SW)</u>	Rec. 1.0' WET
			10				
			10				
			9				
35		S-7 814	10	SW		Same (Deltaic)	Rec. 1.1 WET
			5				
			6				
			6				
40		S-8 804	6	SW		Gr cmf S, t\$	Rec. 1.3 WET
			6				
			6				
			6				
45		S-9 833	11	SW		Gr cmfS, t\$	Rec. 1.2' WET
			8				
			9				
			10				
50		S-10 825	15	SW		Gr cmfS, t(-)\$	Rec. 1.2'
			12				
			13				
			17				
55		S-11	3	SW			

20

DUNN GEOSCIENCE CORPORATION
LATHAM, NEW YORK (518) 783-8102

TEST BORING LOG

BORING NO. DGC-5

PROJECT GE Moreau

SHEET 3 OF 4

CLIENT GE Nott Street

JOB NO. 383-5-2973

45

DEPTH FT.	CASING BLOWS	SAMPLE NUMBER	BLOWS ON SAMPLE SPOON PER 6"	UNIFIED CLASSIFICATION	GRAPHIC LOG	IDENTIFICATION	REMARKS
50		S-11 811	14 15	SW		Gr cmfS, t\$; occ dk S seams	Rec. 1.5' WET
		S-12 807	11 15 18 17	SW		Gr cmfS, t\$	Rec. 1.6' WET
		S-13 806	14 19 14 17	SW		Gr cmfS, t\$, occ dk S seams	Rec. 1.2' WET
		S-14 812	7 17 19 15			Gr cmfS, t\$, t(-) mG (single drop pebble)	Rec. 1.0' WET
55		S-15 815	11 13 17 23	SW		GrBr cmfS, tS,t(-)mG;occ drbk S seams drop pebble	Rec. 1.65' WET
60		S-16 828	11 19 23 26	SW		Same	Rec. 1.9' WET
65		S-17 827	17 21 24 40	SW SM		BrGr cmfS, t\$	66.4'
						Gr fS, a(+) \$; freq. Cy\$ seams (Transitional Glacio-lacustrine)	Rec. 1.1' WET

DUNN GEOSCIENCE CORPORATION
LATHAM, NEW YORK (518) 783-8102

TEST BORING LOG

BORING NO. DGC-5

PROJECT GE Moreau

SHEET 4 OF 4

CLIENT GE Nott Street

JOB NO. 383-5-2973

70

DEPTH FT.	CASING BLOWS	SAMPLE NUMBER	BLOWS ON SAMPLE SPOON PER 6"	UNIFIED CLASSIFICATION	GRAPHIC LOG	IDENTIFICATION	REMARKS
75		S-18 820	16	SM		Gr fS, a(+) \$; freq C&\$ lyr (Transitional Glacio-lacustrine)	Rec. 1.6' WET
			15				
			17				
			21				
80		S-19 803	12	SM		Gr fS, a(+) \$; freq C&\$ lyr	Rec. 1.6' WET
			14				
			18				
			25				
85		S-20 830	15	SM		Gr fS, a(-) \$; occ C&\$ lyr	Rec. 1.0' WET
			20				
			25				
			26				
90		S-21 813	8	ML		Gr \$&C; freq C&\$ seams (Glacio-lacustrine) Bentonite Sand Screen Sand Bentonite	Rec. 2.0' 87 - 84.5 84.5-84 84 - 69 69 - 66 66 - 61
			12				
			17				
			20				
						85.0'	

DUNN GEOSCIENCE CORPORATION LATHAM, NEW YORK (518) 783-8102				TEST BORING LOG			BORING NO. DGC-5I	
PROJECT GE Moreau							SHEET 1 OF 1	
CLIENT GE Nott Street							JOB NO. 383-5-2973	
DRILLING CONTRACTOR Warren George							ELEVATION 327.36'	
PURPOSE Subsurface Geologic Invest./Monitoring Well Install.							ELEVATION 327.36'	
GROUNDWATER				CASING	SAMPLE	CORE	DATUM	USGS
DATE	TIME	DEPTH	CASING	TYPE	Mud Rot.	SS	DATE STARTED	5/23/84
				DIAMETER	4 3/4"	2"	DATE FINISHED	5/23/84
				WEIGHT		140#	DRILLER	R.Gregory
				FALL		30"	INSPECTOR	M. Ianniello

DEPTH FT.	CASING BLOWS	SAMPLE NUMBER	BLOWS ON SAMPLE SPOON PER 6"	UNIFIED CLASSIFICATION	GRAPHIC LOG	IDENTIFICATION	REMARKS
45							
		S-1 834	3 4 7 16			No Recovery	
50		S-2 831	10 9 12 11	SW		Br cmfS, t(+)\$, t(-) mG, drop pebble <u>Brown coarse to fine SAND,</u> <u>trace(+) Silt, trace(-) medium</u> <u>Gravel; drop pebble (SW)</u>	Rec. 2.0' WET
						Bentonite	72 - 71
						Screen	45 - 69
						Sand	71 - 42
						Bentonite	37 - 42
						Cement/bentonite grout	37 - 0

DUNN GEOSCIENCE CORPORATION LATHAM, NEW YORK (518) 783-8102	TEST BORING LOG	BORING NO. DGC-5S
---	------------------------	-----------------------------

PROJECT GE Moreau	SHEET 1 OF 2
CLIENT GE Nott Street	JOB NO. 383-5-2973
DRILLING CONTRACTOR Warren George	ELEVATION 326.87'

GROUNDWATER	CASING	SAMPLE	CDRE	DATUM USGS				
DATE	TIME	DEPTH	CASING	TYPE	Mud Rot.	SS	DATE STARTED	5/24/84
				DIAMETER	4 3/4"	2"	DATE FINISHED	5/24/84
				WEIGHT		140#	DRILLER	Victor Amar
				FALL		30"	INSPECTOR	J. Uruskyj

DEPTH FT.	CASING BLOWS	SAMPLE NUMBER	BLOWS ON SAMPLE SPOON PER 6"	UNIFIED CLASSI- FICATION	GRAPHIC LOG	IDENTIFICATION	REMARKS
25							
		S-1	10	SW		Br cmfS, t\$ <u>Brown coarse to fine SAND, trace Silt (SW)</u>	Rec. 0.9' WET
		803	18				
		828	22				
			28				
30							
35							
40							

DUNN GEOSCIENCE CORPORATION
LATHAM, NEW YORK (518) 783-8102

TEST BORING LOG

BORING NO. DGC-5S

PROJECT GE Moreau

SHEET 2 OF 2

CLIENT GE Nott Street

JOB NO. 383-5-2973

DEPTH FT.	CASING BLOWS	SAMPLE NUMBER	BLOWS ON SAMPLE SPOON PER 6"	UNIFIED CLASSI- FICATION	GRAPHIC LOG	IDENTIFICATION	REMARKS
--------------	-----------------	------------------	--	--------------------------------	----------------	----------------	---------

40

45

50

48.0'

End of Boring @ 48.0'

Bentonite
Sand Pack
Screen
Bentonite
Cement grout

48 - 47
47 - 18
45 - 20
18 - 13
13 - 0

DUNN GEOSCIENCE CORPORATION LATHAM, NEW YORK (518) 783-8102				TEST BORING LOG			BORING NO. DGC-6		
PROJECT GE Moreau							SHEET 1 OF 5		
CLIENT GE Nott Street							JOB NO. 383-5-2973		
DRILLING CONTRACTOR Warren George							ELEVATION 346.71'		
PURPOSE Subsurface Geologic Investigation/Monitoring Well Inst									
GROUNDWATER				CASING	SAMPLE	CORE	DATUM USGS		
DATE	TIME	DEPTH	CASING	TYPE	Mud Rot.	SS	DATE STARTED 5/24/84		
				DIAMETER	4 3/4"	2"	DATE FINISHED 5/31/84		
				WEIGHT		140#	DRILLER R. Gregory		
				FALL		30"	INSPECTOR M. Ianniello		
DEPTH FT.	CASING BLOWS	SAMPLE NUMBER	BLOWS ON SAMPLE SPOON PER 6"	UNIFIED CLASSIFICATION	GRAPHIC LOG	IDENTIFICATION		REMARKS	
5		S-1	2	SM SW		Bk c(-)mfS, a organic \$, rts Orbr c(-)mfS, 1(+)\$(topsoil) Tnbr c(-)mfS, t(+)\$(; pkt Cy\$	3.0'	Rec. 1.6' Dry	
			3						
			2						
			3						
		S-2	4	SW				Br cmfS, t(+)\$(<u>Brown coarse to fine SAND, trace(+)</u> <u>Silt (SW)</u>	Rec. 0.9' Moist
			4						
			3						
		S-3	7	SW				Gr cmfS, t\$, t ⁽⁻⁾ mG; drop pebbles	Rec. 0.9' Moist
			7						
			8						
	S-4	8	SW	Gr cmfS, t(+)\$(, t(-)mG; drop pebble (Deltaic)	Rec. 0.8' Moist				
		8							
		6							
		4							
10	S-5	6	SW	Gr c(+)mfS, t(-)\$(, t(+)mG; drop pebble	Rec. 0.8' Moist				
		6							
		8							
		10							
	S-6	6	SW	Grbr c(+)mfS, t\$, tmG; drop pebbles	Rec. .85' WET				
		5							
		8							
		12							
	S-7	4	SW	Grbr cmfS, t(+)\$(<u>Gray-brown coarse to fine SAND,</u> <u>trace(+) Silt (SW)</u>	Rec. 0.8' WET				
		7							
		11							
		10							
15	S-8	9	SW	Gr c(+)mfS, t\$, 1(-)mfG	Rec. 0.8' WET				
		7							
		9							
		7							
	S-9	10	SW	No Recovery					
		8							
		10							
		11							
		S-10	17						
		UO-1	16						
		829	16						
			16						

DUNN GEOSCIENCE CORPORATION
LATHAM, NEW YORK (518) 783-8102

TEST BORING LOG

BORING NO. DGC-6

PROJECT GE Moreau

SHEET 2 OF 5

CLIENT GE Nott Street

JOB NO. 383-5-2973

DEPTH FT.	CASING BLOWS	SAMPLE NUMBER	BLOWS ON SAMPLE SPOON PER 6"	UNIFIED CLASSIFICATION	GRAPHIC LOG	IDENTIFICATION	REMARKS
20		829	7	SW		Br cmfS, t\$, t mfG	Rec. 0.8' WET
		815	9				
		S-11	9				
			8				
25		401	10	SW		Br c(+)mf S, t\$, s(-) mfG	Rec. 1.1' WET
		S-12	8				
		820	8				
			7				
30		804	8	SW		Br cmfS, t(+) \$ <u>Brown coarse to fine SAND, trace (+) Silt (SW)</u>	Rec. 0.2'
		S-13	6				
		830	8				
			10				
35		809	12	SW		Br cmfS, t(+) \$	Rec. 2.0' WET
		S-14	9				
		823	12				
			12				
40		812	4	SW		Same	Rec. 2.0' WET
		S-15	5				
		822	5				
			8				
45		S-16	5	SW		Gr c(+)mfS, t\$	Rec. 2.0' WET
		829	5				
		807	11				
			15				
50		S-17	9	SW		Grbr cmfS, t\$	Rec. 2.0' WET
		654	12				
			12				
			9				
55		S-18	3	SW		Grbr cmfS, t\$, tmfG	Rec. 2.0' WET
		655	4				
			5				
			6				
60		S-19	5	SW		Gr cmfS, t\$, t(-) mG	Rec. 0.9' WET
		614	10				
			12				
			19				
65		S-20	17	SW		Gr cmfS, t\$, t(-) mG	Rec. 1.1' WET
		616	22				
			20				
			16				
70		S-21	5	SW		Grbr cmfS, t\$, t(-) mG,	Rec. 1.2' WET
		607	9				
			8				
			10				
75		S-22	10	SM		Grbr cmfS, t(+) \$ Grbr mf(+)S, s(+) \$	Rec. 2.0' WET
		607	10				
			11				
			14				
80		S-23	16				

43.5'

PROJECT GE Moreau

SHEET 3 OF 5

CLIENT GE Nott Street

JOB NO. 383-5-2973

45

DEPTH FT.	CASING BLOWS	SAMPLE NUMBER	BLOWS ON SAMPLE SPOON PER 6"	UNIFIED CLASSIFICATION	GRAPHIC LOG	IDENTIFICATION	REMARKS
50	668	S-23	14 17	SW		BrGr cmfS, t\$ occ mfS, s\$ lyrs	Rec. 2.0' WET
		S-24	12 12	SW		Same	Rec. 2.0' WET
		631	14 19				
		616	8 12	SW		BrGr cmfS, t(+)\$	Rec. 1.6' WET
		S-25	15 19				
		602	6 11			BrGr cmfS, t(+)\$, t(-)mfG	Rec. 1.6' WET
		S-26	16 17	SW			
		614					
		654	7 14			Same	Rec. 0.9' WET
		S-27	18 21	SW			
55		655	12 12			BrGr cmfS, t(+)\$	Rec. 0.9' WET
		S-28	15 18	SW			
		607					
			14 17			BrGr cmfS, t(-)\$	Rec. 1.0' WET
		S-29	33 24	SW			
		695					
			26 21			Br cmfS, t(+)\$, t(+)mG	Rec. 1.6' WET
		S-30	35 22	SW			
		677					
			11 10			Br cmfS, t\$	Rec. 1.4' WET
60		S-31	11 10	SW		<u>Brown coarse to fine SAND, trace</u>	
		792	11 12			<u>Silt (SW)</u>	
			17 26			Same	Rec. 2.0' WET
		S-32	22 27	SW			
		677					
			25 23			BrGr cmf(+)S, a(-)\$; occ Cy\$ seams	Rec. 2.0' WET
		S-33	22 21	SM			
		686					
			20 26			BrGr cmf(+)S, a(-)\$	Rec. 1.6' WET
		S-34	23 25	SM		Color Change	
70			11 14			Gr mf(+)S, a(-)\$; occ Cy\$ seams	Rec. 1.5
		S-35	16 16				
		687					

70

DEPTH FT.	CASING BLOWS	SAMPLE NUMBER	BLOWS ON SAMPLE SPOON PER 6"	UNIFIED CLASSIFICATION	GRAPHIC LOG	IDENTIFICATION	REMARKS
75		S-36 778	11	SM		Gr mfS, a(-)\$, occ C&\$ seams	Rec. 1.6' WET
			12				
			14				
			16				
		S-37 783	4	SM		Gr mfS, a(-)\$ <u>Gray medium fine SAND and (-)</u> <u>Silt (SM)</u>	Rec. 1.1' WET
			10				
			16				
			23				
		S-38 685	12	SM		BrGr mfS, s(-)\$	Rec. 1.0' WET
			16				
			30				
			32				
80		S-39 783 687	7	SM	Br mfS, s(+)\$; occ Cy\$ seams	Rec. 2.0' WET	
			15				
			19				
			21				
		S-40 778	695	SM	Br mfS, s\$; occ Cy\$ seams <u>Brown medium fine SAND, some Silt;</u> <u>occasional clayey Silt seams (SM)</u>	Rec. 1.0' WET	
			15				
			24				
			30				
		S-41	696	SM	Same	Rec. 1.0' WET	
			4				
			6				
			14				
	S-42 685	14	SM	Same	Rec. 1.0' WET		
		20					
		26					
		31					
85		S-43 700	15	SM	Gr fS, a\$	Rec. 1.2' WET	
			15				
			19				
			22				
		S-44 700	686	SM	Gr mfS, s\$; occ \$ lyr	Rec. 1.5' WET	
			10				
			21				
			26				
		S-45 862	56	SM	Gr mf(+)\$, a(-)\$; occ mfG, s C&\$ lyrs. (drop pebbles)	Rec. 0.5' WET	
			100/.5				
90		S-46 856	22	SM	Gr mf(+)\$, s(+)\$; occ mfG, 1 C&\$ lyr (Transitional glacio-lacustrine)	Rec. 2.0' WET	
			20				
			21				
			22				
		S-47 885A	9	SM	Gr mf(+)\$, s(-)\$; occ drgr S seams <u>Gray medium fine(+) SAND, some(-)</u> <u>Silt; occasional dark gray Sand</u> <u>seams (SM)</u>	Rec. .75' WET	
			14				
			32				
			35				
	95		S-48	31	SM		

83.0'

DUNN GEOSCIENCE CORPORATION
LATHAM, NEW YORK (518) 783-8102

TEST BORING LOG

BORING NO. DGC-6

PROJECT GE Moreau

SHEET 5 OF 5

CLIENT GE Nott Street

JOB NO. 383-5-2973

95

DEPTH FT.	CASING BLOWS	SAMPLE NUMBER	BLOWS ON SAMPLE SPOON PER 6"	UNIFIED CLASSIFICATION	GRAPHIC LOG	IDENTIFICATION	REMARKS
100		S-48 885	23 31	SM		Gr mfS, s(+)\$; freq drgr S seams	Rec. 0.9' WET
			18			Same	Rec. 1.1' WET
		S-49 884A	25 32 39	SM			
			15			Same	Rec. 0.8' WET
		S-50 887	23 26 30	SM			
						99.5' 100.0'	Rec. 2.0' WET
						Cmf(+)S, a(+)\$	
						Gr \$&C; freq C&\$ lyr, vvd (glacio-lacustrine)	
105		S-51 886A	12 15 15 16	ML			
			11			Same	Rec. 2.0' WET
		S-52 887A	22 24 33	ML		End of Boring @ 104'	
110							

Bentonite
Sand
Screen
Bentonite
Grout

102 - 104
102 - 72
100 - 75
72 - 67
67 - 0

DUNN GEOSCIENCE CORPORATION LATHAM, NEW YORK (518) 783-8102				TEST BORING LOG			BORING NO. DGC-6I	
PROJECT GE Moreau							SHEET 1 OF 1	
CLIENT GE Nott Street							JOB NO. 383-5-2973	
DRILLING CONTRACTOR Warren George							ELEVATION 346.83'	
PURPOSE Monitoring Well Installation							DATUM USGS	
GROUNDWATER				CASING	SAMPLE	CORE	DATUM USGS	
DATE	TIME	DEPTH	CASING	TYPE	Mud Rot.	SS	DATE STARTED 6/1/84	
				DIAMETER	4 3/4"	2"	DATE FINISHED 6/1/84	
				WEIGHT		140#	DRILLER R. Gregory	
				FALL		30"	INSPECTOR M. Ianniello	

DEPTH FT.	CASING BLOWS	SAMPLE NUMBER	BLOWS ON SAMPLE SPOON PER 6"	UNIFIED CLASSIFICATION	GRAPHIC LOG	IDENTIFICATION	REMARKS
50		S-1 888	6 8 11 12	SW		Br cm(+)fS, t(+)s <u>Brown coarse to fine SAND, trace(+)</u> <u>Silt (SW)</u>	Rec. 1.0' WET
						End of Boring @ 78'	
						Bentonite Sand Screen Bentonite Grout	78 - 77 77 - 48 75 - 50 48 - 43 43 - 0

DUNN GEOSCIENCE CORPORATION LATHAM, NEW YORK (518) 783-8102				TEST BORING LOG			BORING NO. DGC-6S	
PROJECT GE Moreau							SHEET 1 OF 1	
CLIENT GE Nott Street							JOB NO. 383-5-2973	
DRILLING CONTRACTOR Warren George							ELEVATION 347.06'	
PURPOSE Monitoring Well Installation							DATE STARTED 6/4/84	
GROUNDWATER				CASING	SAMPLE	CORE	DATUM USGS	
DATE	TIME	DEPTH	CASING	TYPE	Mud Rot.	SS	DATE FINISHED 6/4/84	
				DIAMETER	4 3/4"	2"	DRILLER R. Gregory	
				WEIGHT		140#	INSPECTOR J. Uruskyj	
				FALL		30"		

DEPTH FT.	CASING BLOWS	SAMPLE NUMBER	BLOWS ON SAMPLE SPOON PER 6"	UNIFIED CLASSIFICATION	GRAPHIC LOG	IDENTIFICATION	REMARKS
30		S-1	6	SW		Br cmfS, t\$, tfG (drop-stone)	Rec. 1.0' WET
			5			<u>Brown coarse to fine SAND, trace</u>	
			6			<u>Silt, trace fine Gravel; drop-</u>	
			9			<u>stone (SW)</u>	
						End of Boring @ 53.0'	
						Bentonite	53.0 - 52.0'
						Sand	52.0 - 19.6
						Screen	50.0 - 22.0
						Bentonite	19.6 - 14.6
						Cement grout	14.6 - 0.0

DUNN GEOSCIENCE CORPORATION LATHAM, NEW YORK (518) 783-8102				TEST BORING LOG			BORING NO. DGC-7	
PROJECT GE Moreau							SHEET 1 OF 4	
CLIENT GE Nott Street							JOB NO. 383-5-2973	
DRILLING CONTRACTOR Warren George							ELEVATION 349.24'	
PURPOSE Subsurface Geologic Inv./Monitor Wells							DATUM USGS	
GROUNDWATER				CASING	SAMPLE	CORE		
DATE	TIME	DEPTH	CASING	TYPE	Mud Rot.	SS	DATE STARTED 5/24/84	
				DIAMETER	4 3/4"	2"	DATE FINISHED 5/30/84	
				WEIGHT		140#	DRILLER Victor Aimar	
				FALL		30"	INSPECTOR J. Uruskyj	
DEPTH FT.	CASING BLOWS	SAMPLE NUMBER	BLOWS ON SAMPLE SPOON PER 6"	UNIFIED CLASSIFICATION	GRAPHIC LOG	IDENTIFICATION		REMARKS
5		S-1	1	SM		DkBr cmfS, a Cy\$; rts, mld Br cmfS, 1(-) Cy\$ (topsoil) 1.0'	(Deltaic)	Rec. 1.3' Dry
			1					
			2	SW				
			2					
10		S-2	6		Br cmfS, t\$ <u>Brown coarse to fine SAND,</u> <u>trace Silt (SW)</u>	Rec. 0.5' Dry		
			7	SW				
			7					
			10					
15		S-3	6		Br cmfS, t\$, tmfG; drop-stones	Rec. 0.9' Moist		
			9	SW				
			14					
			16					
20		S-4	8		Br cmfS, t\$, tmfG; drop-stones	Rec. 0.7' Moist		
			13	SW				
			17					
			18					

DUNN GEOSCIENCE CORPORATION
LATHAM, NEW YORK (518) 783-8102

TEST BORING LOG

BORING NO. DGC-7

PROJECT GE Moreau

SHEET 2 OF 4

CLIENT GE Nott Street

JOB NO. 383-5-2973

20

DEPTH FT.	CASING BLOWS	SAMPLE NUMBER	BLOWS ON SAMPLE SPOON PER 6"	UNIFIED CLASSIFICATION	GRAPHIC LOG	IDENTIFICATION	REMARKS	
25		S-5	9	SW		Br cmfS, t\$, tfG; drop-stones (Deltaic)	Rec. .7' WET	
			12					
			12					
			13					
30		802	15	SW		Br cmfS, t(+)Cy\$, tmfG; drop-stones	Rec. 1.2' WET	
		S-6	19					
			21					
			25					
35		801	16	SM		Br mfS, s(-)Cy\$ <u>Brown medium fine SAND, some(-)</u> <u>Clayey Silt (SM)</u>	Rec. .7' WET	
			S-7					17
			805					23
								18
40		810	14	SM		Br fS, aCy\$	Rec. .8' WET	
		S-8	21					
			21					
			23					
45		879A	7	SM		Br fS, sCy\$	Rec. 1.2' WET	
			S-9					13
								18
								23

DUNN GEOSCIENCE CORPORATION
LATHAM, NEW YORK (518) 783-8102

TEST BORING LOG

BORING NO. DGC-7

PROJECT GE Moreau

SHEET 3 OF 4

CLIENT GE Nott Street

JOB NO. 383-5-2973

45

DEPTH FT.	CASING BLOWS	SAMPLE NUMBER	BLOWS ON SAMPLE SPOON PER 6"	UNIFIED CLASSIFICATION	GRAPHIC LOG	IDENTIFICATION	REMARKS
45		879B	18	SW		Br cmfS, 1 \$, tfG (Deltaic)	Rec. 1.4' WET
			24				
		S-10	28				
			39				
50		880A	8	SM		Brgr mfS, s(+)\$, tmG; drop-stones Br \$&C seam @ 50.5'	Rec. 1.0' WET
			16				
		S-11	18				
			22				
55		880B	16	SW		Br cmfS, t(+) \$; lyr mfS, s(+)Cy\$	Rec. 1.2' WET
			21				
		S-12	27				
			28				
60		S-13	18	SW		Br cmfS, t(+) \$; lyr mfS, sCy\$	Rec. 1.2' WET
			17				
		881A	21				
			24				
65		881A	12	SM		Gr mfS, a(-)\$ <u>Gray medium fine SAND, and</u> <u>(-) Silt (SM)</u>	Rec. 1.0' WET
			18				
		S-14	19				
			23				

DUNN GEOSCIENCE CORPORATION LATHAM, NEW YORK (518) 783-8102	TEST BORING LOG	BORING NO. DGC-7
---	------------------------	-------------------------

PROJECT GE Moreau	SHEET 4 OF 4
--------------------------	---------------------

CLIENT GE Nott Street	JOB NO. 383-5-2973
------------------------------	---------------------------

DEPTH FT.	CASING BLOWS	SAMPLE NUMBER	BLOWS ON SAMPLE SPOON PER 6"	UNIFIED CLASSIFICATION	GRAPHIC LOG	IDENTIFICATION	REMARKS
70		S-15 882	17	SM		Gr mfs, s(+)\$; occ Cy\$ seams (Deltaic) 73.0'	Rec. .7' WET
			25				
			27				
			32				
75		882A S-16	21	ML		Gr \$1, fS; freq ½" thick \$&C lysrs	Rec. 1.0' WET
			25				
			28				
			36				
80		883 S-17	20	SM		Gr fS, s\$; freq ¼" \$&C lysrs	Rec. .8' WET
			31				
			29				
			37				
85		883A S-18	23	SM		BrGr fS, l\$ <u>Brown-Gray fine SAND, little Silt (SM)</u> 89.0'	Rec. 1.0' WET
			28				
			29				
			37				
90		884 S-19	5	ML		Gr \$&C; vvd, freq Gr \$t, fS seams End of Boring @ 92.0' Bentonite 92 - 90 Screen 88 - 65 Sand Pack 90 - 63 Bentonite 63 - 58 Cement 58 - 0	Rec. 2.0' WET
			13				
			13				
			19				
						(Glacio-lacustrine)	

DUNN GEOSCIENCE CORPORATION LATHAM, NEW YORK (518) 783-8102				TEST BORING LOG			BORING NO. DGC-7S	
PROJECT GE Moreau							SHEET 1 OF 1	
CLIENT GE Nott Street							JOB NO. 383-5-2973	
DRILLING CONTRACTOR Warren George							ELEVATION 349.04'	
PURPOSE Monitoring Well Installation							DATE STARTED 5/30/84	
GROUNDWATER				CASING	SAMPLE	CORE	DATUM USGS	
DATE	TIME	DEPTH	CASING	TYPE	Mud Rot	SS	DATE FINISHED 6/1/84	
				DIAMETER	4 3/4"	2"	DRILLER Victor Aimar	
				WEIGHT		140#	INSPECTOR J. Uruskyj	
				FALL		30"		

DEPTH FT.	CASING BLOWS	SAMPLE NUMBER	BLOWS ON SAMPLE SPOON PER 6"	UNIFIED CLASSIFICATION	GRAPHIC LOG	IDENTIFICATION	REMARKS
30		S-1	8	SM		Br mfS, s\$; drop-stone <u>Brown medium to fine SAND, some Silt; drop-stone (SM)</u>	Rec. 1.0' WET
		888A	9				
			13				
			13				
35						End of Boring @ 48.0'	
						Bentonite 48 - 47	
						Sand 47 - 20	
						Screen 45 - 22	
						Bentonite 20 - 15	
						Grout 15 - 0	

DUNN GEOSCIENCE CORPORATION LATHAM, NEW YORK (518) 783-8102					TEST BORING LOG			BORING NO. DGC-8	
PROJECT GE Moreau								SHEET 1 OF 5	
CLIENT GE Nott Street								JOB NO. 383-5-2973	
DRILLING CONTRACTOR Warren George, Inc.								ELEVATION 348.83'	
PURPOSE Subsurface Geologic Invest./Monitoring Wells								DATE STARTED 6/4/84	
GROUNDWATER					CASING	SAMPLE	CORE	DATUM USGS	
DATE	TIME	DEPTH	CASING	TYPE	Mud Rot	SS	DATE FINISHED 6/6/84		
				DIAMETER	4 3/4"	2"	DRILLER V. Aimar		
				WEIGHT		140#	INSPECTOR M. Ianniello		
				FALL		30"			

DEPTH FT.	CASING BLOWS	SAMPLE NUMBER	BLOWS ON SAMPLE SPOON PER 6"	UNIFIED CLASSIFICATION	GRAPHIC LOG	IDENTIFICATION	REMARKS
		S-1	1	SM		DkBrBk cm(+)fS, a(-) o\$ DrBrOr cmfS, 1 o\$ (Deltaic)	.8 Rec. = 1.5' Dry
			1	SW			
			2				
			2				
5		S-2	5	SW	Gr cmfS, t\$ <u>Gray coarse to fine SAND, trace Silt (SW)</u>	Rec. = .9 Moist	
			9				
			9				
			7				
10		S-3	3	SW	Gr cmfS, t\$, tFG	Rec. = .9 Moist	
			6				
			7				
			8				
15		S-4	9	SW	Gr cmfS, t(+) \$	Rec. = 1.0 Moist	
			12				
			15				
			15				

DUNN GEOSCIENCE CORPORATION LATHAM, NEW YORK (518) 783-8102	TEST BORING LOG	BORING NO. DGC-8
---	------------------------	-------------------------

PROJECT GE Moreau	SHEET 2 OF 5
--------------------------	---------------------

CLIENT GE Nott Street	JOB NO. 383-5-2973
------------------------------	---------------------------

DEPTH FT.	CASING BLOWS	SAMPLE NUMBER	BLOWS ON SAMPLE SPOON PER 6"	UNIFIED CLASSIFICATION	GRAPHIC LOG	IDENTIFICATION	REMARKS
20		S-5	8	SW		BrGr cmfS t(-)\$, t(+) mfg	Rec. = 1.0 WET
			13				
			14				
			17				
25		S-6 913	10	SW		Same; occ. DkBkRd S seams	Rec. = 1.0 WET
			13				
			15				
			18				
30		S-7 916	9	SW		Same	Rec. = 1.1 WET
			12				
			17				
			16				
35		S-8 920	11	SW		BrGr cmfS, t(-) \$, t mfg occ. DkBkRd S seams	Rec. = 1.0 WET
			22				
			29				
			26				
40		S-9	11	SW		Same	Rec. = 1.6 WET
			19				
			20				
			20				
45							

(Deltaic)

Brown-Gray coarse to fine SAND,
trace(-) Silt, trace medium
fine Gravel (SW)

DUNN GEOSCIENCE CORPORATION
LATHAM, NEW YORK (518) 783-8102

TEST BORING LOG

BORING NO. DGC-8

PROJECT GE Moreau

SHEET 3 OF 5

CLIENT GE Nott Street

JOB NO. 383-5-2973

45

DEPTH FT.	CASING BLOWS	SAMPLE NUMBER	BLOWS ON SAMPLE SPOON PER 6"	UNIFIED CLASSIFICATION	GRAPHIC LOG	IDENTIFICATION	REMARKS
			8				
		S-10	12	SW		BrGr cm (+) f S, t(+)\$; occ. drbkrd S seams	Rec. = 1.5 WET
		918	17				
			17			(Deltaic)	
50							
		S-11	10	SW		BrGr cmfS, t\$; occ. dkbkrd S seams	Rec. = 1.65 WET
		919	15				
			19				
			18				
55							
		S-12	8	SW		BrGr cmfS, t(+) \$	Rec. = 1.5 WET
		915	14			<u>Brown-Gray coarse to fine SAND,</u>	
			24			<u>trace(+) Silt (SW)</u>	
			21				
60							
		S-13	17	SW		BrGr cmfS, t(+) \$	Rec. = 1.6 WET
		925	19				
			19				
			18				
65							
		S-14	24	SW		BrGr cmfS, t(+) \$; occ. mfS, s(-)	Rec. = 1.4 WET
		917	42			\$ lyrs.	
			40				
			34				

DUNN GEOSCIENCE CORPORATION
LATHAM, NEW YORK (518) 783-8102

TEST BORING LOG

BORING NO. DGC-8

PROJECT GE Moreau

SHEET 4 OF 5

CLIENT GE Nott Street

JOB NO. 383-5-2973

70

DEPTH FT.	CASING BLOWS	SAMPLE NUMBER	BLOWS ON SAMPLE SPOON PER 6"	UNIFIED CLASSIFICATION	GRAPHIC LOG	IDENTIFICATION	REMARKS
70		924 S-15	10	SM		BrGr mf(+)S, s(-) \$, t(-) mfG; occ. \$&C seams (Deltaic)	Rec. = 1.0 WET
			16				
			25				
			30				
75		923 S-16	13	SM		Same	Rec. = 1.1 WET
			17				
			20				
			18				
80		S-17 922	15	SW		BrGr cmfS, t(+) \$	Rec. = 1.3 WET
			25				
			26				
			26				
85		956 S-18	10	SM		Gr mfs, a(+) \$; occ. gr \$&C sms. (Transitional glaciolacustrine)	Rec. = 1.2 WET
			18				
			28				
			31				
90		957 S-19	16	SW		Gr mfs, 1 \$ <u>Gray medium fine SAND, little Silt (SW)</u>	Rec. = 1.3 WET
			25				
			28				
			21				
						84.0'	

DUNN GEOSCIENCE CORPORATION
LATHAM, NEW YORK (518) 783-8102

TEST BORING LOG

BORING NO. DGC-8

PROJECT GE Moreau

SHEET 5 OF 5

CLIENT GE Nott Street

JOB NO. 383-5-2973

95

DEPTH FT.	CASING BLOWS	SAMPLE NUMBER	BLOWS ON SAMPLE SPOON PER 6"	UNIFIED CLASSIFICATION	GRAPHIC LOG	IDENTIFICATION	REMARKS	
100		958	14	ML		Gr \$ a, mfs; \$&C lysrs.	Rec. = 1.2 WET	
			18					
		S-20	20					
			30					
105		959	23	SP		Gr mfs, 1\$ <u>Gray medium fine SAND, little Silt (SP)</u>	Rec. = 1.3 WET	
			29					
		S-21	34					
			31					
110						104.0'		
						(Glacio-lacustrine)		
		S-22	12	ML		Gr \$1,fs , freq. gr \$&C lysrs.	Rec. = 2.0 WET	
			13					
			960	15	ML		106.2'	
				31				
		957A	6	ML		Gr \$&C; freq. gr \$ seams	Rec. = 2.0 WET	
			13			Gr \$&C; occ. gr \$ seams		
		S-23	14	ML		End of Boring @ 108.0'		
			15					
						Well Installation:		
						Bentonite	109.0 - 107.0'	
						Sand Pack	107.0 - 73.0'	
						Screen	106.0 - 75.0'	
						Bentonite	73.0 - 68.0'	
						Cement Grout	68.0 - 0.0'	

DUNN GEOSCIENCE CORPORATION LATHAM, NEW YORK (518) 783-8102				TEST BORING LOG			BORING NO. DGC-8S	
PROJECT GE Moreau							SHEET 1 OF 1	
CLIENT GE Nott Street							JOB NO. 383-5-2973	
DRILLING CONTRACTOR Warren George, Inc.							ELEVATION 348.56'	
PURPOSE Monitoring Well Installation							DATUM USGS	
GROUNDWATER				CASING	SAMPLE	CORE	DATE STARTED 6/6/84	
DATE	TIME	DEPTH	CASING	TYPE	Mud Rot.	SS	DATE FINISHED 6/7/84	
				DIAMETER	3/4"	2"	DRILLER V. Aimar	
				WEIGHT		140#	INSPECTOR J. Uruskyj	
				FALL		30"		

DEPTH FT.	CASING BLOWS	SAMPLE NUMBER	BLOWS ON SAMPLE SPOON PER 6"	UNIFIED CLASSIFICATION	GRAPHIC LOG	IDENTIFICATION	REMARKS
30		S-1	8			Br cmfS, t\$	Rec. = .9 WET
		937	9				
			14				
			14				
						End of Boring @ 48.0'	
						Well Installation:	
						Bentonite 48.0 - 47.0'	
						Sand Pack 47.0 - 19.0'	
						Screen 45.0 - 22.0'	
						Bentonite 19.0 - 14.0'	
						Cement Grout 14.0 - 0.0'	

DUNN GEOSCIENCE CORPORATION LATHAM, NEW YORK (518) 783-8102		TEST BORING LOG		BORING NO. DGC-9	
---	--	------------------------	--	----------------------------	--

PROJECT GE Moreau

CLIENT GE Nott Street SHEET 1 OF 4

DRILLING CONTRACTOR Warren George, Inc. JOB NO. 383-5-2973

PURPOSE Subsurface Geologic Invest./Monitoring Well Install. ELEVATION 333.96'

GROUNDWATER CASING SAMPLE CORE DATUM USGS

DATE TIME DEPTH CASING TYPE Mud Rot. SS DATE STARTED 6/5/84

DIAMETER 4 3/4" 2" DATE FINISHED 6/5/84

WEIGHT 140# DRILLER R. Gregory

FALL 30" INSPECTOR M. Ianniello

DEPTH FT.	CASING BLOWS	SAMPLE NUMBER	BLOWS ON SAMPLE SPOON PER 6"	UNIFIED CLASSIFICATION	GRAPHIC LOG	IDENTIFICATION	REMARKS
-----------	--------------	---------------	------------------------------	------------------------	-------------	----------------	---------

		S-1	1	SM		Bk cmfS, t(+) o\$; rts. (Humus)	Rec. = 2.0 Dry
			2				
			2				
			4				

5		S-2	4	SW		DrBr cmfS, t\$, t(-) mfG (Deltaic)	Rec. = 1.0 Moist
			8				
			9				
			9				

10		S-3	4	SW		GrBr cmf S, t(-) \$ <u>Gray-Brown coarse to fine SAND, trace(-) Silt (SW)</u>	Rec. = 1.6 Moist
			6				
			10				
			10				

15		S-4	3	SW		GrBr cmfs, t(+) \$	Rec. = 1.4 Moist
			6				
			11				
			14				

20

DEPTH FT.	CASING BLOWS	SAMPLE NUMBER	BLOWS ON SAMPLE SPOON PER 6"	UNIFIED CLASSIFICATION	GRAPHIC LOG	IDENTIFICATION	REMARKS
20		S-5	7	SW		BrGr cm(+)fS, t(+)\$; occ. \$ lyrs. (Deltaic)	Rec. = 1.4 Moist
			8				
			11				
			14				
25		S-6 929	7	SW		BrGr cmfS, t(+)\$; occ. Br Cy\$ S lyrs.	Rec. = 1.35 WET
			9				
			14				
			15				
30		S-7 928	14	SW		BrGr cm(+)fS, t(-) \$; freq. DkRdBk S seams	Rec. = .85 WET
			15				
			21				
			23				
35		S-8 927	8	SW		BrGr cmfS, t(-)\$; occ. BkRd S seams	Rec. = 1.0 WET
			17				
			16				
			15				
40		S-9 955	15	SW		BrGr cmfS, t(-)\$; occ. BkRd S seams	Rec. = 1.1 WET
			12				
			16				
			18				
45							

PROJECT GE Moreau	SHEET 3 OF 4
--------------------------	---------------------

CLIENT GE Nott Street	JOB NO. 383-5-2973
------------------------------	---------------------------

DEPTH FT.	CASING BLOWS	SAMPLE NUMBER	BLOWS ON SAMPLE SPOON PER 6"	UNIFIED CLASSIFICATION	GRAPHIC LOG	IDENTIFICATION	REMARKS
45		S-10 954	12	SW		Same	Rec. = 1.1 WET
			12				
			15				
			16				
50		S-11 953	10	SW		BrGr cmf S, t \$; freq. dkBk S seams (Deltaic)	Rec. = 1.2 WET
			15				
			17				
			16				
55		S-12 951	8	SW		Same	Rec. = 1.1 WET
			16				
			18				
			23				
60		S-13 952	20	SW		BrGr cmf S, t(-) \$	Rec. = 1.3 WET
			27				
			28				
			25				
65		S-14 930	37	SW		GrBr cmfS, t(+) \$; occ. dkBk S seams	Rec. = 1.6 WET
			29				
			30				
			33				
70							

DUNN GEOSCIENCE CORPORATION LATHAM, NEW YORK (518) 783-8102				TEST BORING LOG			BORING NO. 9S	
PROJECT GE Moreau							SHEET 1 OF 1	
CLIENT GE Nott Street							JOB NO. 383-5-2973	
DRILLING CONTRACTOR Warren George, Inc.							ELEVATION 335.40'	
PURPOSE Monitoring Well Installation							DATUM USGS	
GROUNDWATER				CASING	SAMPLE	CORE	DATE STARTED 6/7/84	
DATE	TIME	DEPTH	CASING	TYPE Mud Rot.	SS		DATE FINISHED 6/7/84	
				DIAMETER 4 3/4"	2"		DRILLER R. Gregory	
				WEIGHT	140#		INSPECTOR M. Ianniello	
				FALL	30"			

DEPTH FT.	CASING BLOWS	SAMPLE NUMBER	BLOWS ON SAMPLE SPOON PER 6"	UNIFIED CLASSIFICATION	GRAPHIC LOG	IDENTIFICATION	REMARKS
33							
		S-1	50	SW		BrGr cmfS, t(-) \$, t(-) mG; occ. Dk S sms.	Rec. = 2.0 WET
		938	36				
35			20				
			25				
						End of Boring @ 38.0'	
						Well Installation:	
						Bentonite	38.0 - 37.0'
						Sand	37.0 - 20.0'
						Screen	23.0 - 35.0'
						Bentonite	20.0 - 15.0'
						Grout	15.0 - 0.0'

DUNN GEOSCIENCE CORPORATION LATHAM, NEW YORK (518) 783-8102	TEST BORING LOG	BORING NO. DGC-10
---	------------------------	-----------------------------

PROJECT GE Moreau	SHEET 1 OF 3
--------------------------	---------------------

CLIENT GE Nott Street	JOB NO. 383-5-2973
------------------------------	---------------------------

DRILLING CONTRACTOR Warren George, Inc.	ELEVATION 336.77'
--	--------------------------

PURPOSE Subsurface Geologic Inv./Monitoring Well Installation	DATUM USGS
--	-------------------

GROUNDWATER	CASING Mud Rot.	SAMPLE SS	DATE STARTED 6/7/84
--------------------	------------------------	------------------	----------------------------

DATE	TIME	DEPTH	CASING	TYPE	DIA 4 3/4"	SIZE 2"	DATE FINISHED 6/11/84
-------------	-------------	--------------	---------------	-------------	-------------------	----------------	------------------------------

				WEIGHT		140#	DRILLER R. Gregory
--	--	--	--	---------------	--	------	---------------------------

				FALL		30"	INSPECTOR M. Ianniello
--	--	--	--	-------------	--	-----	-------------------------------

DEPTH FT.	CASING BLOWS	SAMPLE NUMBER	BLOWS ON SAMPLE SPOON PER 6"	UNIFIED CLASSIFICATION	GRAPHIC LOG	IDENTIFICATION	REMARKS
5		S-1 939	1	SM SW		Bk cmf S, a o\$; rts. (Humus) OrBr cmfS, t(+)\$; rts. (Deltaic) BrGr c(+) mfS, t(-) \$	Rec. = 2.0 Moist 1.0 Rec. = 1.6 Moist
			2				
			1				
			3				
10		S-2 940	6	SW		GrBr c(+) mfS, t(+)\$	Rec. = 1.4 Moist
			7				
			10				
			10				
15		S-3 941	5	SW		GrBr c(+) mfS, t(+)\$	Rec. = 1.4 Moist
			6				
			7				
			14				
20		S-4 942	4	SW		GrBr c(+) mfS, t(+)\$, t(-) mfG	Rec. = 1.4 Moist
			7				
			8				
			8				

DEPTH FT.	CASING BLOWS	SAMPLE NUMBER	BLOWS ON SAMPLE SPOON PER 6"	UNIFIED CLASSIFICATION	GRAPHIC LOG	IDENTIFICATION	REMARKS
25		S-5 943	7	SW		GrBr c(+)mfS, t(+) \$, t(-) mfG; occ. Br Cy\$ sms. (Deltaic)	Rec. = 1.1 Moist
			7				
			9				
			11				
30		S-6 944	6	SW		GrBr cmf(+) S, t(+) \$ <u>Gray-Brown coarse to fine(+) SAND, trace(+) Silt (SW)</u>	Rec. = 1.6 WET
			7				
			14				
			9				
35		S-7 945	6	SM		GrBr cmf(+) S, s(+) \$; freq. Cy\$ seams occ. Bk S seams	Rec. = 1.8 WET
			4				
			4				
			9				
40		S-8 946	11	SM		GrBr mf(+)S, s \$; freq. Cy\$ seams	Rec. = 1.0 WET
			16				
			19				
			21				
45		S-9	12	SW		GrBr cmfS, t(+) \$; occ. Cy\$ seams	Rec. = 1.1 WET
			10				
			11				
			15				

PROJECT GE Moreau

SHEET 3 OF 3

CLIENT GE Nott Street

JOB NO. 383-5-2973

DEPTH FT.	CASING BLOWS	SAMPLE NUMBER	BLOWS ON SAMPLE SPOON PER 6"	UNIFIED CLASSIFICATION	GRAPHIC LOG	IDENTIFICATION	REMARKS
45		S-10 948	9	SW		GrBr cmf S, t(-) \$ <u>Gray-Brown coarse to fine SAND, trace(-) Silt (SW)</u>	Rec. = 1.0 WET
			12				
			14				
			16				
50						49.0'	
55		S-11 949	9	SM		Gr mf(+) S, a \$, freq. Cy\$ lyrs. (Transitional)	Rec. = 2.0 WET
			10				
			10				
			7				
55						55.0'	
60		S-12 942	2	ML		Gr \$&C; freq. C&\$ sms., vvd. (Glacio-lacustrine) <u>Gray SILT & CLAY; frequent Clay & Silt seams, varved (ML)</u>	Rec. = 2.0 WET
			3				
			5				
			14				
60						60.0'	
65		S-13 941	2	ML		Same End of Boring @ 60.0' Well Installation Bentonite 60.0 - 55.0' Sand 55.0 - 40.0' Screen 53.0 - 43.0' Bentonite 40.0 - 35.0' Grout 35.0 - 0.0'	Rec. = 2.0 WET
			2				
			2				
			3				
65							

DUNN GEOSCIENCE CORPORATION LATHAM, NEW YORK (518) 783-8102				TEST BORING LOG			BORING NO. DGC-101	
PROJECT GE Moreau							SHEET 1 OF 1	
CLIENT GE Nott Street							JOB NO. 383-5-2973	
DRILLING CONTRACTOR Warren George, Inc.							ELEVATION 336.67'	
PURPOSE Monitoring Well Installation							DATE STARTED 6/11/84	
GROUNDWATER				CASING	SAMPLE	CORE	DATUM USGS	
DATE	TIME	DEPTH	CASING	TYPE	Mud Rot.	SS	DATE FINISHED 6/11/84	
				DIAMETER	4 3/4"	2"	DRILLER R. Gregory	
				WEIGHT		140#	INSPECTOR J. Uruskyj	
				FALL		30"		
DEPTH FT.	CASING BLOWS	SAMPLE NUMBER	BLOWS ON SAMPLE SPOON PER 6"	UNIFIED CLASSIFICATION	GRAPHIC LOG	IDENTIFICATION		REMARKS
35		S-1	7 10 15 19			Br cmfS, 1\$		Rec. = 0.6' WET
40						Brown coarse to fine SAND, little Silt		
45						46.0'		
						End of Boring @ 46.0'		
						Well Installation		
						Bentonite 46.0 - 45.0'		
						Sand Pack 45.0 - 30.0'		
						Screen 43.0 - 33.0'		
						Bentonite Grout 30.0 - 25.0'		
						25.0 - 0.0'		

DUNN GEOSCIENCE CORPORATION LATHAM, NEW YORK (518) 783-8102				TEST BORING LOG			BORING NO. DGC-10S	
PROJECT GE Moreau						SHEET 1 OF 1		
CLIENT GE Nott Street						JOB NO. 383-5-2973		
DRILLING CONTRACTOR Warren George, Inc.						ELEVATION 336.64'		
PURPOSE Monitoring Well Installation						DATUM USGS		
GROUNDWATER				CASING	SAMPLE	CORE		
DATE	TIME	DEPTH	CASING	TYPE	Mud Rot.	SS	DATE STARTED 6/12/84	
				DIAMETER	4 3/4"	2"	DATE FINISHED 6/12/84	
				WEIGHT		140#	DRILLER R. Gregory	
				FALL		30"	INSPECTOR J. Uruskyj	
DEPTH FT.	CASING BLOWS	SAMPLE NUMBER	BLOWS ON SAMPLE SPOON PER 6"	UNIFIED CLASSI- FICATION	GRAPHIC LOG	IDENTIFICATION	REMARKS	
25								
		S-1	3			Br c(-)mfS, l\$	26.3	
			5			Br Cy\$ l, fS; freq. 1/8" Gr	27.1	
			14			\$&C seams		
			16			Br mfS, s\$		
30								
35								
							36.0'	
						End of Boring @ 36.0'		
						Well Installation		
						Bentonite	36.0 - 35.0'	
						Sand	35.0 - 12.0'	
						Screen	33.0 - 15.0'	
						Bentonite	12.0 - 7.0'	
40						Grout	7.0 - 0.0'	

DUNN GEOSCIENCE CORPORATION LATHAM, NEW YORK (518) 783-8102	TEST BORING LOG	BORING NO.
---	------------------------	-------------------

PROJECT GE Moreau	DGC-11
--------------------------	--------

CLIENT GE Nott Street	SHEET 1 OF 5
------------------------------	---------------------

DRILLING CONTRACTOR Warren George, Inc.	JOB NO. 383-5-2973
--	---------------------------

PURPOSE Subsurface Geologic Invest./Monitoring Well Install.	ELEVATION 350.51'
---	--------------------------

GROUNDWATER	CASING	SAMPLE	CORE	DATUM USGS
--------------------	---------------	---------------	-------------	-------------------

DATE	TIME	DEPTH	CASING	TYPE Mud Rot.	SS	DATE STARTED 6/7/84
-------------	-------------	--------------	---------------	----------------------	-----------	----------------------------

				DIAMETER 4 3/4"	2"	DATE FINISHED 6/11/84
--	--	--	--	------------------------	----	------------------------------

				WEIGHT	140#	DRILLER v. Aimar
--	--	--	--	---------------	------	-------------------------

				FALL	30"	INSPECTOR J. Uruskyj
--	--	--	--	-------------	-----	-----------------------------

DEPTH FT.	CASING BLOWS	SAMPLE NUMBER	BLOWS ON SAMPLE SPOON PER 6"	UNIFIED CLASSIFICATION	GRAPHIC LOG	IDENTIFICATION	REMARKS
------------------	---------------------	----------------------	-------------------------------------	-------------------------------	--------------------	-----------------------	----------------

		S-1	2 3 3 3	SM		Bk cmfS, s Cy\$, tfG (Humus) OrBr cmfS t(-)\$, tfG Br cmfS, t\$, tfG	Rec. = 1.4' Dry
		S-2	3 4 4 5	SW		Br cmfS, t\$, tfG <u>Brown coarse to fine SAND, trace Silt, trace fine Gravel (SW)</u>	Rec. = 1.4 Dry
5		S-3	3 5 6 8	SW		Br cmfS, t(+)\$	Rec. = 1.0 Dry
		S-4	8 8 7 10	SW		Br cmfS, t(+)\$; freq. rd-bk lyrs.	Rec. = .8 Dry
		S-5	5 7 11 13	SW		Br cmfS, 1(-) Cy\$, 1 mfG	Rec. = 1.1 Dry
10		S-6	9 11 13 12	SW		Br cmfS, t\$, lfG	Rec. = 1.0 Moist
		S-7	4 6 7 10	SW		Br cmfS, 1 Cy\$, tfG	Rec. = .8 Moist
		S-8	3 7 8 8	SW		Br cmfS, 1 Cy\$, tfG	Rec. = .7 Moist
15		S-9	3 6 6 7	SW		Same	Rec. = .7 Moist
		857 S-10	7 8 8	SW		Br cmfS, 1(-) Cy\$, lfG	Rec. = 1.0 WET

M. Ianniello

PROJECT GE Moreau	SHEET 2 OF 5
--------------------------	---------------------

CLIENT GE Nott Street	JOB NO. 383-5-2973
------------------------------	---------------------------

DEPTH FT.	CASING BLOWS	SAMPLE NUMBER	BLOWS ON SAMPLE SPOON PER 6"	UNIFIED CLASSIFICATION	GRAPHIC LOG	IDENTIFICATION	REMARKS
25		S-11	4	SW		Br cmfS, t Cy\$, t(+)fG	Rec. = 1.0 WET
			8				
			9				
			9				
30		S-12	6	SW		Same	Rec. = .9 WET
			10				
			12				
			10				
35		S-13	5	SW		Br cmfS, t\$, lmfG	Rec. = 1.0 WET
			12				
			13				
			12				
40		S-14	7	SW		Br cmfS, t\$, l(-) fG	Rec. = .9 WET
			11				
			16				
			11				
45		S-15	5	SW		Br cmfS, t\$, t(+)fG	Rec. = 1.1 WET
			7				
			9				
			9				
50		S-16	6	SW		Same	Rec. = 1.0 WET
			6				
			7				
			7				
55		890 S-17	6	SW		Br cmfS, t\$, l(+)mfG	Rec. = 1.3 WET
			5				
			6				
			7				
60		891 S-18	5	SW		Same	Rec. = 1.0 WET
			5				
			12				
			15				
65		892 S-19	13	SW		Br cmfS, t\$, s(-)fG	Rec. = .9 WET
			19				
			20				
			15				
70		893 S-20	10	SW		Br cmfS, t\$, l mfG	Rec. = 1.1 WET
			12				
			16				
			12				
75		894 S-21	12	SW		Br cmfS, t(+) Cy\$, tfG	Rec. = 1.0 WET
			12				
			17				
			17				
80		895 S-22	5	SW		Br cmfS, t Cy\$	Rec. = .9 WET
			6				
			8				
			13				
85		896	12			Brown coarse to fine SAND, trace clayey Silt	
			16				

PROJECT GE Moreau

SHEET 3 OF 5

CLIENT GE Nott Street

JOB NO. 383-5-2973

DEPTH FT.	CASING BLOWS	SAMPLE NUMBER	BLOWS ON SAMPLE SPOON PER 6"	UNIFIED CLASSIFICATION	GRAPHIC LOG	IDENTIFICATION	REMARKS
50		S-23	17			Br cmfS, t Cy\$	Rec. = .8 WET
			17				
		897	4			GnGr cmfS, t Cy\$	Rec. = .9 WET
		S-24	7				
			17				
			23				
		898	14			Same	48.4'
			14			Bk cmfS t\$	48.8'
		S-25	13				Rec. = 1.1 WET
			15				
55		899	13			Gr \$, tfs	50.0'
			17				
		S-26	20			Gr \$, lfs	Rec. = .8 WET
			20				
		900	13				
		S-27	14			Br mfs, a\$; occ. \$&C seams	Rec. = 1.1 WET
			18				
			20				
		901	14				
		S-28	16			Br cmfS, l\$; freq. bkrd seams	Rec. = 1.4 WET
60			17				
			20				
		902	10			BrGr cmfS, l\$	Rec. = 1.0 WET
		S-29	17				
			19				
			20				
		890B	12			BrGr cmfS, t\$, tfG	Rec. = 1.1 WET
		S-30	14				
			15				
			19				
65		889B	11			BrGr cmfS s, t\$	Rec. = 1.5 WET
		S-31	13				
			16				
			17				
		891B	7			Br cmfS, 1(+)\$	Rec. = 1.6 WET
		S-32	13				
			17				
			21				
		892B	14			Br cmfS, l\$	Rec. = 1.3 WET
		S-33	16				
70			20				
			20				
		893B	10			Br cmfS, t(+)\$	Rec. = 1.1 WET
		S-34	17				
			24				
			28				
		894B	14			Br fS, s\$	Rec. = 1.0 WET
		S-35	15				
			16				
			17				

DUNN GEOSCIENCE CORPORATION LATHAM, NEW YORK (518) 783-8102				TEST BORING LOG		BORING NO. DGC-11	
PROJECT GE Moreau						SHEET 4 OF 5	
CLIENT GE Nott Street						JOB NO. 383-5-2973	
DEPTH FT.	CASING BLOWS	SAMPLE NUMBER	BLOWS ON SAMPLE SPOON PER 6"	UNIFIED CLASSIFICATION	GRAPHIC LOG	IDENTIFICATION	REMARKS
75		895B	8	SM		Br mfs, s\$ <u>Brown medium fine SAND, some Silt</u>	Rec. = 1.2 WET
		S-36	11				
			14				
			19				
75		896B	16	SM		Br mfs, s\$ Br cmfS 1\$ 73.5'	Rec. = 1.4 WET
		S-37	18				
			20				
			25				
75		118	10	SW		Br cmfS, 1\$; 1/2" \$&C seams @ 75.8'	Rec. = 1.3 WET
		S-38	11				
			32	SM		Br mfs, s\$	
			38				
80		119	6	SM		Br mfs, s\$	Rec. = 1.8 WET
		S-39	16				
			22				
			25				
80		120	16	SM		Br cm(+)fS, s(-) \$; occ. Cy\$ seams	Rec. = 1.6 WET
		S-40	19				
			19				
			17				
85		121	13	SM		Br cmf(+)S, s(-)\$, t(-) G	Rec. = 1.8 WET
		S-41	16				
			19	SM		Gr fS, a(-) Cy\$ (Transitional Glaciolacustrine) 82.0'	
			26				
85		122	9	SM		Gr cmf(+)\$, s(+) \$ <u>Gray coarse to fine(+) SAND, some(+) Silt</u>	Rec. = 1.7 WET
		S-42	9				
			20				
			28				
85		124	11	SM		Gr mfs, a(-)\$; occ. Cy\$ seams	Rec. = 1.9 WET
		S-43	18				
			18				
			22				
90		125	8	SM		Same	Rec. = 1.6 WET
		S-44	15				
			22				
			29				
90		126	17	SM		Gr mf(+)S, a(-) \$; freq. drk. \$ seams	Rec. = 1.6 WET
		S-45	28				
			35				
			42				
90		S-46	12	SM		Same	Rec. = 1.9 WET
		127	19				
			27				
			25				
95		S-47	10	ML		DkGr Cy\$ a, fS, freq. C&\$ seams (Glaciolacustrine)	Rec. = 2.0 WET
		128	16				
			15				
			20				
95		S-48	7	ML		DrGr Cy\$; freq. C&\$ seams	Rec. = 2.0 WET
		129	10				

DUNN GEOSCIENCE CORPORATION LATHAM, NEW YORK (518) 783-8102				TEST BORING LOG			BORING NO. DGC-111	
PROJECT GE Moreau							SHEET 1 OF 1	
CLIENT GE Nott Street							JOB NO. 383-5-2973	
DRILLING CONTRACTOR Warren George, Inc.							ELEVATION 350.51'	
PURPOSE Monitoring Well Installation							DATUM USGS	
GROUNDWATER				CASING	SAMPLE	CORE		
DATE	TIME	DEPTH	CASING	TYPE	Mud Rot.	SS	DATE STARTED 6/12/84	
				DIAMETER	4 3/4"	2"	DATE FINISHED 6/12/84	
				WEIGHT		140#	DRILLER R. Gregory	
				FALL		30"	INSPECTOR M. Ianniello	
DEPTH FT.	CASING BLOWS	SAMPLE NUMBER	BLOWS ON SAMPLE SPOON PER 6"	UNIFIED CLASSIFICATION	GRAPHIC LOG	IDENTIFICATION		REMARKS
46						Br cmfS, t(-)\$, occ. drk RdBr S seams		Rec. = 1.1 WET
		S-1	7					
			10					
48			13					
			17					
						End of Boring @ 83.0'		
						Well Installation		
						Bentonite	83.0 - 82.0'	
						Sand	82.0 - 42.0'	
						Screen	45.0 - 80.0'	
						Bentonite	42.0 - 37.0'	
						Grout	37.0 - 0.0'	

DUNN GEOSCIENCE CORPORATION LATHAM, NEW YORK (518) 783-8102				TEST BORING LOG			BORING NO. DGC-11S	
PROJECT GE Moreau							SHEET 1 OF 1	
CLIENT GE Nott Street							JOB NO. 383-5-2973	
DRILLING CONTRACTOR Warren George, Inc.							ELEVATION 350.32'	
PURPOSE Monitoring Well Installation							DATE STARTED 6/13/84	
GROUNDWATER				CASING	SAMPLE	CORE	DATUM USGS	
DATE	TIME	DEPTH	CASING	TYPE	Mud Rot.	SS	DATE FINISHED 6/13/84	
				DIAMETER	4 3/4"	2"	DRILLER V. Amair	
				WEIGHT		140#	INSPECTOR J. Uruskyj	
				FALL		30"		
DEPTH FT.	CASING BLOWS	SAMPLE NUMBER	BLOWS ON SAMPLE SPOON PER 6"	UNIFIED CLASSIFICATION	GRAPHIC LOG	IDENTIFICATION		REMARKS
30						Br cmfs, t\$, s mfg		Rec. = .6 WET
		S-1	10					
		236	12					
			14					
35						End of Boring @ 48.0'		
						Well Installation		
						Bentonite	48.0 - 47.0'	
						Sand	47.0 - 19.0'	
						Screen	45.0 - 22.0'	
						Bentonite	19.0 - 12.0'	

DUNN GEOSCIENCE CORPORATION LATHAM, NEW YORK (518) 783-8102				TEST BORING LOG			BORING NO. DGC-12	
PROJECT GE/Moreau							SHEET 1 OF 4	
CLIENT GE Nott Street							JOB NO. 383-5-2973	
DRILLING CONTRACTOR Warren George, Inc.							ELEVATION 343.79'	
PURPOSE Subsurface Geologic Invest./Monitoring Well Install.							DATE STARTED 6/12/84	
GROUNDWATER				CASING	SAMPLE	CORE	DATUM USGS	
DATE	TIME	DEPTH	CASING	TYPE	Mud Rot.	SS	DATE FINISHED 6/14/84	
				DIAMETER	4 3/4"	2"	DRILLER R. Gregory	
				WEIGHT		140#	INSPECTOR M. Ianniello	
				FALL		30"		

DEPTH FT.	CASING BLOWS	SAMPLE NUMBER	BLOWS ON SAMPLE SPOON PER 6"	UNIFIED CLASSIFICATION	GRAPHIC LOG	IDENTIFICATION	REMARKS
5		S-1 140	2	SM		DkBr cmfS, ao\$; rts. (Humus) BrOr cmfS, t(+) \$ (Deltaic) Br cmfS, t(-)\$ <u>Brown coarse to fine SAND,</u> <u>trace(-) Silt (SW)</u>	Rec. = 1.6 Dry
			1				
			1				
			2				
10		S-2 141	7	SW			Rec. = 1.5 Moist
			6				
			6				
			7				
15		S-3 142	8	SW			Rec. = 1.6 Moist
			9				
			9				
			16				
20		S-4	5	SW		Same	Rec. = 1.2 Moist
			4				
			4				
			7				

DUNN GEOSCIENCE CORPORATION
LATHAM, NEW YORK (518) 783-8102

TEST BORING LOG

BORING NO. DGC-12

PROJECT GE Moreau

SHEET 2 OF 4

CLIENT GE Nott Street

JOB NO. 383-5-2973

DEPTH FT.	CASING BLOWS	SAMPLE NUMBER	BLOWS ON SAMPLE SPOON PER 6"	UNIFIED CLASSIFICATION	GRAPHIC LOG	IDENTIFICATION	REMARKS
20		S-5	10	SW		Br cmfS, t(+)\$; occ. dkbr Cy\$ seams	Rec. = 1.3 Moist
			9				
			10				
			14				
25		S-6 143	26	SM		Br mf(+) S, s(-)\$	Rec. = 2.0 WET-Moist
			23				
			24				
			28				
30		144 S-7	16	SW		Gr cmfS, t(+)\$; occ. dk \$ seams, occ. Br Cy\$ seams	Rec. = 1.7 WET
			24				
			38				
			38				
35		S-8 145	24	SM		BrGr mfS, a(-)\$; freq. Cy\$ seams	Rec. = 2.0 WET
			18				
			18				
			16				
40		S-9 146	15	SW		Br cmfS, t(-)\$ <u>Brown coarse to fine SAND,</u> <u>trace(-) Silt (SW)</u>	Rec. = 2.0 WET
			14				
			12				
			15				
45							

DUNN GEOSCIENCE CORPORATION
LATHAM, NEW YORK (518) 783-8102

TEST BORING LOG

BORING NO. DGC-12

PROJECT GE Moreau

SHEET 3 OF 4

CLIENT GE Nott Street

JOB NO. 383-5-2973

45

DEPTH FT.	CASING BLOWS	SAMPLE NUMBER	BLOWS ON SAMPLE SPOON PER 6"	UNIFIED CLASSIFICATION	GRAPHIC LOG	IDENTIFICATION	REMARKS
50		S-10 147	10	SW		Br cmfS, t(-) \$	Rec. = .8 WET
			10				
			11				
			14				
55		S-11 148	16	SW		BrGr cmfS, t(+) \$ <u>Brown-Gray coarse to fine SAND, trace(+) Silt (SW)</u> (Deltaic)	Rec. = 1.0 WET
			17				
			19				
			22				
60		S-12 149	25	SW		BrGr cmf S, t(-) \$	Rec. = 1.0 WET
			30				
			25				
			26				
65		S-13 150	18	SM		BrGr mf(+) S, s \$; occ. Cy\$ sms. (Transitional)	Rec. = 1.2 WET
			21				
			26				
			28				
70		S-14 151	9	ML		Gr \$&C; freq. C&\$ lyrs., vvd. (Glaciolacustrine) <u>Gray SILT & CLAY; frequent Clay & Silt layers, varved</u> End of Boring @ 67.0'	Rec. = 2.0
			9				
			10				
			14				

DUNN GEOSCIENCE CORPORATION
 LATHAM, NEW YORK (518) 783-8102

TEST BORING LOG

BORING NO. DGC-12

PROJECT GE Moreau

SHEET 4 OF 4

CLIENT GE Nott Street

JOB NO. 383-5-2973

DEPTH FT.	CASING BLOWS	SAMPLE NUMBER	BLOWS ON SAMPLE SPOON PER 6"	UNIFIED CLASSI- FICATION	GRAPHIC LOG	IDENTIFICATION	REMARKS
--------------	-----------------	------------------	--	--------------------------------	----------------	----------------	---------

						Well Installation	
--	--	--	--	--	--	-------------------	--

Bentonite	67.0 - 65.0'
Sand	65.0 - 45.0'
Screen	63.0 - 48.0'
Bentonite	45.0 - 40.0'
Grout	40.0 - 0.0'

DUNN GEOSCIENCE CORPORATION LATHAM, NEW YORK (518) 783-8102				TEST BORING LOG			BORING NO. DGC-12S	
PROJECT GE/Moreau							SHEET 1 OF 1	
CLIENT GE Nott Street							JOB NO. 383-5-2973	
DRILLING CONTRACTOR Warren George, Inc.							ELEVATION 344.02'	
PURPOSE Monitoring Well Installation							DATE STARTED 6/15/84	
GROUNDWATER				CASING	SAMPLE	CORE	DATUM USGS	
DATE	TIME	DEPTH	CASING	TYPE	Mud. Rot	SS	DATE FINISHED 6/15/84	
				DIAMETER	4 3/4"	2"	DRILLER V. Amair	
				WEIGHT		140#	INSPECTOR M. Ianniello	
				FALL		30"		
DEPTH FT.	CASING BLOWS	SAMPLE NUMBER	BLOWS ON SAMPLE SPOON PER 6"	UNIFIED CLASSIFICATION	GRAPHIC LOG	IDENTIFICATION		REMARKS
21								
		S-1 158	11 12 17 16	SM		Br mfS, s\$; occ. Cy\$ lyrs.		Rec. = 1.8 WET
23		S-2 159	11 12 17 20	SM		LtBr mf(+)S, a(-)\$; occ. Cy\$ lyrs.		Rec. = 1.9 WET
25		S-3 160	21 30 45 50	SM		Br mfS, l(+)\$; occ. Cy\$ lyrs.		Rec. = 1.9 WET
27						<u>Brown medium fine SAND, little (+) Silt; occasional Clayey Silt layers (SM)</u>		
						End of Boring @ 36.0'		
						Well Installation		
						Bentonite 36.0 - 35.0'		
						Sand 35.0 - 14.0'		
						Screen 33.0 - 17.0'		
						Bentonite 14.0 - 9.0'		
						Grout 9.0 - 0.0'		

DUNN GEOSCIENCE CORPORATION LATHAM, NEW YORK (518) 783-8102				TEST BORING LOG			BORING NO. DGC-13	
PROJECT GE/Moreau							SHEET 1 OF 1	
CLIENT GE Nott Street							JOB NO. 383-5-2973	
DRILLING CONTRACTOR Warren George, Inc.							ELEVATION 285'	
PURPOSE Subsurface Geologic Invest./Monitoring Well Install.							DATE STARTED 6/19/84	
GROUNDWATER				CASING	SAMPLE	CORE	DATUM USGS	
DATE	TIME	DEPTH	CASING	TYPE	Mud Rot.	SS	DATE FINISHED 6/19/84	
				DIAMETER	4 3/4"	2"	DRILLER V. Amair	
				WEIGHT		140#	INSPECTOR M. Ianniello	
				FALL		30"		
DEPTH FT.	CASING BLOWS	SAMPLE NUMBER	BLOWS ON SAMPLE SPOON PER 6"	UNIFIED CLASSIFICATION	GRAPHIC LOG	IDENTIFICATION		REMARKS
5		S-1	2	SM		Bk cmfS, a o\$ (Humus) OrBr cmfS, 1(+) \$; rts.	1.0'	Rec. = 1.5 Dry
			1					
			3					
			5					
5		S-2	5	SW		BrGr cmfS, t(+)\$; occ. BkRd S seams <u>Brown-Gray coarse to fine SAND,</u> <u>trace (+) Silt; occasional Black-</u> <u>Red Sand seams (SW)</u>	8.5'	Rec. = 1.6 WET
			8					
			9					
			10					
10		S-3 238	4	ML		DrGr Cy\$; freq. C&\$ lyrs., vvd. <u>Dark Gray CLAYEY SILT; frequent</u> <u>Clay & Silt layers, varved (ML)</u>		Rec. = 2.0 WET
			4					
			4					
			3					
15								
20						End of Boring @ 10.0'		
						Well Installation		
						Bentonite	10.0 - 9.5'	
						Sand	9.5 - 3.0'	
						Screen	8.5 - 3.5'	
					Bentonite	3.0 - 2.0'		
					Grout	2.0 - 0.0'		
					Stickup	3.5		

DUNN GEOSCIENCE CORPORATION LATHAM, NEW YORK (518) 783-8102		TEST BORING LOG	BORING NO. DGC-14
---	--	------------------------	-----------------------------

PROJECT GE/Moreau	SHEET 1 OF 5
--------------------------	---------------------

CLIENT GE Nott Street	JOB NO. 383-5-2973
------------------------------	---------------------------

DRILLING CONTRACTOR Warren George, Inc.	ELEVATION 339.13'
--	--------------------------

PURPOSE Subsurface Geologic Invest./Monitoring Well Install.	DATUM USGS
---	-------------------

GROUNDWATER	CASING Mud. Rot	SAMPLE SS	CORE	DATE STARTED 8/1/84
--------------------	------------------------	------------------	-------------	----------------------------

DATE	TIME	DEPTH	CASING	TYPE	DIAMETER 4 3/4"	2"	DATE FINISHED 8/2/84
-------------	-------------	--------------	---------------	-------------	------------------------	-----------	-----------------------------

				WEIGHT		140#	DRILLER V. Amair
--	--	--	--	---------------	--	-------------	-------------------------

				FALL		30"	INSPECTOR M. Ianniello/ R. Sutch
--	--	--	--	-------------	--	------------	--

DEPTH FT.	CASING BLOWS	SAMPLE NUMBER	BLOWS ON SAMPLE SPOON PER 6"	UNIFIED CLASSIFICATION	GRAPHIC LOG	IDENTIFICATION	REMARKS
-----------	--------------	---------------	------------------------------	------------------------	-------------	----------------	---------

5		S-1	3	SW		DkBr mfS, a(+), s o \$	Dry Rec. = 1.3
			9				
			11				
			11				

5		S-2	4	SW		Br c(+)mfS, t\$	WET Rec. = 0.9
			7				
			6				
			9				

10		S-3	5	SW		Br cmfS, t(+) \$	WET Rec. = 0.7
			8				
			13				
			18				

15		S-4	12	SW		Br cmfS, t(+) \$; occ. dkBr S seams	WET Rec. 0.7
			21				
			23				
			30				

DUNN GEOSCIENCE CORPORATION
LATHAM, NEW YORK (518) 783-8102

TEST BORING LOG

BORING NO. DGC-14

PROJECT GE/Moreau

SHEET 2 OF 5

CLIENT GE Nott Street

JOB NO. 383-5-2973

20

DEPTH FT.	CASING BLOWS	SAMPLE NUMBER	BLOWS ON SAMPLE SPOON PER 6"	UNIFIED CLASSIFICATION	GRAPHIC LOG	IDENTIFICATION	REMARKS
25		S-5	11	SW		BrGr c(+)mfS, t\$; t(+)mfG; mfG lyr. @ 21.4'	Rec. = 1.0 WET
			15				
			21				
			26				
30		S-6	8	SW		Br cmfS, t(+)\$, tmfG; 1" mfG lyr. @ 26.0'	Rec. = 1.1 WET
			19				
			22				
			38				
35		S-7	7	SM		Br mf(+)S, a(-)\$; freq. Bk sms.	Rec. = 1.1 WET
			12				
			9				
			16				
40		S-8	31	SW		BrGr cmfS, t\$, t(+)fG; freq. BkRd S seams	Rec. = 1.2 WET
			60				
			61				
			48				
45		S-9	8	SW		Br cmfS, t\$; occ. Bk S sms.	Rec. = 1.0 WET
			16				
			19				
			23				

DUNN GEOSCIENCE CORPORATION
LATHAM, NEW YORK (518) 783-8102

TEST BORING LOG

BORING NO. DGC-14

PROJECT GE/Moreau

SHEET 3 OF 5

CLIENT GE Nott Street

JOB NO. 383-5-2973

DEPTH FT.	CASING BLOWS	SAMPLE NUMBER	BLOWS ON SAMPLE SPOON PER 6"	UNIFIED CLASSIFICATION	GRAPHIC LOG	IDENTIFICATION	REMARKS
45		S-10	13	SM		BrGr cmf(+)S, s(-)\$; freq. Bk S seams	Rec. = 1.7 WET
			20				
			16				
			17				
50		S-11	8	SM		BrGr cm(+)fS, 1\$; freq. Bk S seams	Rec. = .9 WET
			13				
			16				
			29				
55		S-12	14	SM		GrBr m(+)fS, s\$; freq. Bk S seams	Rec. = .9 WET
			42				
			66				
			67				
60		S-13	16	SM		GrBr cmf S, t\$	Rec. = 1.1 WET
			30				
			32				
			34				
65		S-14	10	SM		Gr mf(+)S, s\$; ½" \$&C lyr.	Rec. = 1.0 WET
			24				
			38				
			35				
70							

DUNN GEOSCIENCE CORPORATION
LATHAM, NEW YORK (518) 783-8102

TEST BORING LOG

BORING NO. DGC-14

PROJECT GE/Moreau

SHEET 4 OF 5

CLIENT GE Nott Street

JOB NO. 383-5-2973

70

DEPTH FT.	CASING BLOWS	SAMPLE NUMBER	BLOWS ON SAMPLE SPOON PER 6"	UNIFIED CLASSIFICATION	GRAPHIC LOG	IDENTIFICATION	REMARKS
75		S-15	11	SM		Gr mf(+)S, s \$; freq. Bk S seams, 1/2" S&C lyr.	Rec. = 1.1 WET
			20				
			26				
			33				
80		S-16	19	SM		Gr mf(+) S, s(+)\$; freq. Bk S seams	Rec. = 1.0 WET
			30				
			33				
			42				
85		S-17	9	SM		Gr mf(+)S, s(+)\$; 1/2" C&\$ seams, freq. Bk sms.	Rec. = 1.0 WET
			21				
			26				
			29				
90		S-18	10	SM		(TRANSITIONAL ZONE) Gr mf(+)S, a \$; occ. \$&C seams	Rec. = 1.0 WET
			25				
			28				
			35				
95		S-19	7	SM	color change	BrGr mfS, a(-)\$; occ. \$&C seams	Rec. = 1.1
			19				
			24				
			33				

DUNN GEOSCIENCE CORPORATION
 LATHAM, NEW YORK (518) 783-8102

TEST BORING LOG

BORING NO. DGC-14

PROJECT GE/Moreau

SHEET 5 OF 5

CLIENT GE Nott Street

JOB NO. 383-5-2973

95

DEPTH FT.	CASING BLOWS	SAMPLE NUMBER	BLOWS ON SAMPLE SPOON PER 6"	UNIFIED CLASSIFICATION	GRAPHIC LOG	IDENTIFICATION	REMARKS
		S-20	20	SM		Gr mf(+)S, s\$	Rec. = .9 WET
			31				
			31				
			30				
100						98.0'	
		S-21	5	SM		Gr fS a, \$ & C sms. vvd.	Rec. = 1.9 WET
			10				
			19				
			15				
105						102.5	
						Osterberg thin-walled piston sample	
						104.5	
						End of Boring @ 104.5'	
						Cave in to 102.5'	
						Bentonite 101.5'	
						Sand 101.0' - 70.0'	
						Screen 98.0' - 73.0'	
						Bentonite 70.0' - 65.0'	
						Grout 65.0' - 0.0'	
110						100.5 total PVC	
						75.5 blank	
						25.0 screen 10-slot	
						Sand Morie #1/2	

DUNN GEOSCIENCE CORPORATION LATHAM, NEW YORK (518) 783-8102				TEST BORING LOG			BORING NO. DGC-14S		
PROJECT GE/Moreau							SHEET 1 OF 1		
CLIENT GE Nott Street							JOB NO. 383-5-2973		
DRILLING CONTRACTOR Warren George, Inc.							ELEVATION 341.68'		
PURPOSE Monitoring Well Installation							DATUM USGS		
GROUNDWATER				CASING	SAMPLE	CORE	DATUM USGS		
DATE	TIME	DEPTH	CASING	TYPE	Mud Rot.	None	DATE STARTED 8/6/84		
				DIAMETER	4 3/4"		DATE FINISHED 8/6/84		
				WEIGHT			DRILLER V. Amair		
				FALL			INSPECTOR M. Ianniello		
DEPTH FT.	CASING BLOWS	SAMPLE NUMBER	BLOWS ON SAMPLE SPOON PER 6"	UNIFIED CLASSI- FICATION	GRAPHIC LOG	IDENTIFICATION			REMARKS
						Grout 10.0 - 0.0' Bentonite 15.0 - 10.0' Screen 48.0 - 18.0' Sand 50.0 - 15.0' Bentonite 51.0 - 50.0' PVC 50.5 total Blank 20.5 Screen 30.0 Stickup 2.5			

DUNN GEOSCIENCE CORPORATION LATHAM, NEW YORK (518) 783-8102				TEST BORING LOG			BORING NO. DGC-15		
PROJECT GE/Moreau							SHEET 1 OF 6		
CLIENT GE Nott Street							JOB NO. 383-5-2973		
DRILLING CONTRACTOR Warren George, Inc.							ELEVATION 352.39'		
PURPOSE subsurface Geologic Invest./Monitoring Well Install.							DATUM USGS		
GROUNDWATER				CASING	SAMPLE	CORE			
DATE	TIME	DEPTH	CASING	TYPE	Mud Rot.	SS			
				DIAMETER	4 3/4"	2"	DATE STARTED 8/6/84		
				WEIGHT		140#	DATE FINISHED 8/8/84		
				FALL		30"	DRILLER V. Amair		
							INSPECTOR M. Ianniello		
DEPTH FT.	CASING BLOWS	SAMPLE NUMBER	BLOWS ON SAMPLE SPOON PER 6"	UNIFIED CLASSIFICATION	GRAPHIC LOG	IDENTIFICATION		REMARKS	
5		S-1				No Recovery; Root plugs			
		S-2	5	SW		Tn c(+)mfS, t\$, tfG		Rec. = 1.5 Dry	
			6						
			6						
			9						
		S-3	5	SW		Br cmfS, t\$; Bk S seams		Rec. = .75 Damp	
			8						
			11						
			12						
		S-4	8	SW		Br cmfS, t\$; Bk S seams		Rec. = .9 Damp	
			11						
			11						
	12								
10		S-5	4	SW		Same		Rec. = .75 Damp	
			6						
			8						
		S-6	6	SW		Br cmf S, t\$		Rec. = 1.6 Damp	
			8						
			8						
			8						
		S-7	4	SW		Br c(+) mf S, t\$, 1(+)m(+)fG; Bk S seams		Rec. = 1.0 Damp	
			8						
			7						
			10						
	15		S-8	7	SW		Br c(+)mfS, t\$; lyr. mfG		Rec. = 1.0 Damp
		10							
		10							
		11							
		S-9	8	SW		Br cmfS, t\$; lyr. mfG		Rec. = .9 Damp	
			12						
			12						
			14						
20			S-10	20	SW		Br cmfS, t\$, 1 mfG		Rec. = 1.4 Damp
				23					
				17					
				17					

DUNN GEOSCIENCE CORPORATION
LATHAM, NEW YORK (518) 783-8102

TEST BORING LOG

BORING NO. DGC-15

PROJECT GE/Moreau

SHEET 2 OF 6

CLIENT GE Nott Street

JOB NO. 383-5-2973

20

DEPTH FT.	CASING BLOWS	SAMPLE NUMBER	BLOWS ON SAMPLE SPOON PER 6"	UNIFIED CLASSIFICATION	GRAPHIC LOG	IDENTIFICATION	REMARKS		
25		S-11	6	GP		Br mfGs, cmfS, t\$	20.3	Rec. = 1.0 Damp	
			12	SW					
			12						
			17						
			S-12	14		SW	Br cmfS, t\$	23.7	Rec. = 1.2 Damp
				16		GP			
				15		GP			
			S-13	16		SW	Br mfG t, cS Br cmfS, t\$	25.0	Rec. = 1.1 Damp
				9					
				18					
		21							
		S-14	21	SW	Br cmfS, t\$, s mfG		Rec. = .7 Damp		
			23						
			26						
			16						
		S-15	25	SW	Br cmfS, t\$		Rec. = .8 Damp		
			7						
			11						
			14						
30		S-16	18	GP	Br mfGs, cmfS, t\$ Br cmfS, t\$	31.0	Rec. = 1.1 Damp		
								20	
								22	
								22	
			S-17	9	SW	Br cmf(+)S, t(+)\$, freq. Bk S seams	Rec. = .9 WET		
				14					
				18					
				18					
			S-18	13	SP	Br mfGs, cmfS, t\$ Br cmfS, t\$	36.0	Rec. = 1.1 WET	
				15					
		16							
		18							
		S-19	10	SW	Br cmfS, t\$		Rec. = 1.0 WET		
			27						
			30						
			30						
		S-20	12	SW	Br cmfS, t(+)\$, t(-)mG		Rec. = 1.2 WET		
			22						
			22						
			21						
40		S-21	4	SW	Br cmfS, t(+)\$, t(-)fG		Rec. = .9 WET		
								10	
								17	
								24	
			S-22	14	SM	Br cmf(+)S, l(+)\$, t mfG		Rec. = 1.0 WET	
				20					
				25					
				23					
	45		S-23	11					
				17					

45

DEPTH FT.	CASING BLOWS	SAMPLE NUMBER	BLOWS ON SAMPLE SPOON PER 6"	UNIFIED CLASSIFICATION	GRAPHIC LOG	IDENTIFICATION	REMARKS			
50		S-23	23	SM		Br cmf(+)S, s(-)\$	Rec. = 1.5 WET			
			24							
				13				SM	Br cmf(+)S, l\$, tmg; G pkt.	Rec. = 1.2 WET
		S-24		15						
				18						
				20						
				7				SM	Br cmfS, l(-)\$	Rec. = 1.3 WET
		S-25		15						
				19						
				19						
				12				SW	Br cmfS, t(+)\$	Rec. = 1.1 WET
		S-26		13						
			15							
			15							
			9	SW	Br cmfS, t\$	Rec. = .8 WET				
	S-27		12							
			14							
			15							
55		S-28		9	SW	Br cmfS, t(+)\$	Rec. = 1.6 WET			
				16						
				15						
				20						
			10	SW	Br cmfS, t(+)\$, tmG	Rec. = 1.3 WET				
	S-29		17							
			20							
			21							
60		S-30		18	SW	Br cmfS, l\$, tmG	Rec. = 1.2 WET			
				23						
				24						
				35						
			21	SW	Br cm(+)fS, t\$; freq. Bk S seams	Rec. = 1.0 WET				
	S-31		42							
			50							
			45							
			19	SW	Br cmfS, t(+)\$; pkt. decayed organic material	Rec. = 1.2 WET				
	S-32		23							
			24							
			20							
65		S-33		14	SW	Br cmfS, t\$; occ. Bk S sms.	Rec. = 1.7 WET			
				34						
				50						
				60						
			40	SW	BrGr cmfS, t\$	Rec. = 1.6 WET				
	S-34		52							
			50							
			52							
70		S-35		27	SW	(Hydraulic Sands) BrGr cmfS, t\$	Rec. = 1.4 WET			
				43						
				68						
				90						

DUNN GEOSCIENCE CORPORATION
LATHAM, NEW YORK (518) 783-8102

TEST BORING LOG

BORING NO. DGC-15

PROJECT GE/Moreau

SHEET 4 OF 6

CLIENT GE Nott Street

JOB NO. 383-5-2973

DEPTH FT.	CASING BLOWS	SAMPLE NUMBER	BLOWS ON SAMPLE SPOON PER 6'	UNIFIED CLASSIFICATION	GRAPHIC LOG	IDENTIFICATION	REMARKS	
75		S-36	32	SW		BrGr cmfS, t\$	Rec. = 1.7 WET	
			68					71.0
			50	SM		BrGr mf(+)S, s\$		
			50					
		S-37	24	SW		BrGr cmfS, t\$; freq. Bk S seams	Rec. = .7 WET	
			45					
			45					
			34					
			S-38	13		SW	BrGr cmfS, t\$	Rec. = 1.0 WET
				15				
		22						
			28					
	S-39		13	SW	BrGr cmfS, t\$	Rec. = 1.0 WET		
			15					
		20						
		31						
		S-40	17	SM	BrGr cmfS, 1(-)\$	Rec. = 1.5 WET		
			18					
	21							
	24							
80		S-41	8	SW	Br cm(+)fS, t\$	Rec. = 1.0 WET		
			14					
			20					
			25					
		S-42	18	SW	BrGr cmf(+)S, t(+) \$	Rec. = 1.0 WET		
			27					
			25					
			27					
			S-43	18	SM	BrGr mf(+)S, t(+) \$	Rec. = 1.1 WET	
				20				
		26						
		34						
	S-44	13	SM	Same	Rec. = 1.2 WET			
		24						
		22						
		30	(TRANS.)	Gr mf(+)S, s\$; occ. Cy\$ seams	88.0			
		S-45	14			SM	Gr mfS, a\$; freq. C&\$ seams	Rec. = 1.4 WET
			22					
	25							
		25						
		S-46	14	SM	Gr mfS, 1(+) \$	Rec. = 1.0		
			22					
	25							
	25							
	S-47		SM	Shelby Tube	Rec. = 1.5			
	S-48		SM					
		1						
95								

70

DEPTH FT.	CASING BLOWS	SAMPLE NUMBER	BLOWS ON SAMPLE SPOON PER 6"	UNIFIED CLASSIFICATION	GRAPHIC LOG	IDENTIFICATION	REMARKS
95		S-48	9	SM		Gr cm(+)fS, 1(+)§	Rec. = 1.0 WET
			24				
		S-49	17				
			21				
			30				
			32				
		S-50	25				
			43				
			47				
	100		36				
		S-51	8				
			18				
	32						
	35						
	S-52	23					
		33					
		33					
		40					
105	S-53	18					
		36					
		50					
		52					
	S-54	37					
		37					
		60					
		62					
	S-55	12					
		17					
		25					
110		37					
	S-56	13					
		29					
		43					
		44					
	S-57	19					
		36					
		41					
		47					
115	S-58	40					
		35					
		37					
		33					
	S-59	17					
		16					
		23					
		19					
	S-60	26					
		21					
		31					
120		37					

95

100

105

110

115

120

99.65

107.8

109.3

113.8

116.0

(Glaciolacustrine)

DUNN GEOSCIENCE CORPORATION
LATHAM, NEW YORK (518) 783-8102

TEST BORING LOG

BORING NO.
DGC-16

PROJECT GE/Moreau

CLIENT GE Nott Street

SHEET 1 OF 2

DRILLING CONTRACTOR Warren George, Inc.

JOB NO. 383-5-2973

PURPOSE Subsurface Geologic Invest./Monitoring Well Install.

ELEVATION 322.43'

GROUNDWATER

CASING Mud Rot. **SAMPLE** SS **CORE**

DATUM USGS

DATE **TIME** **DEPTH** **CASING** **TYPE** **DIAMETER** **WEIGHT** **FALL**

Mud Rot. SS 4 3/4" 2" 140# 30"

DATE STARTED 8/13/84

DATE FINISHED 8/13/84

DRILLER V. Amair

INSPECTOR R. Sutch/M. Ianniello

DEPTH FT.	CASING BLOWS	SAMPLE NUMBER	BLOWS ON SAMPLE SPOON PER 6"	UNIFIED CLASSIFICATION	GRAPHIC LOG	IDENTIFICATION	REMARKS
		S-1	1	SM		DkBr cmfS, 1 o \$; rts. TnOr cmfS, t\$	1.1 — Rec. = 1.7 Dry
			2	SW			
			3				
			2				
5		S-2	2	SW	BrTn cm(+)fS, t\$	Rec. = 1.1 WET	
			7				
			12				
			12				
10		S-3	2	SW	Br cmfS, t\$, occ. lyr. \$&C, freq. pkt. C&\$; occ. seams Dk Br m(+)f S	Rec. = 1.3 WET	
			3				
			6				
			7				
15		S-4	4	SW	Br cm(+)fS, t(+) \$; freq. Dk S seams	Rec. = 1.4 WET	
			8				
			8				
			7				
20							

DUNN GEOSCIENCE CORPORATION
LATHAM, NEW YORK (518) 783-8102

TEST BORING LOG

BORING NO. DGC-16

PROJECT GE/Moreau

SHEET 2 OF 2

CLIENT GE Nott Street

JOB NO. 383-5-2973

DEPTH FT.	CASING BLOWS	SAMPLE NUMBER	BLOWS ON SAMPLE SPOON PER 6"	UNIFIED CLASSIFICATION	GRAPHIC LOG	IDENTIFICATION	REMARKS
20		S-5	3	SW		Br cm(+)fS, t(+)§; occ. C&§ seams	Rec. = 1.4 WET
			4	SW			
			6				
			15				
	25						
		S-6	7	SW		Br cmfS, t§; lyr. fS, a§	Rec. = 1.0 WET
			14				
			14				
			12				
30							
		S-7	6	SW		Alt. lyr. Br cmfS, t§; freq. Bk seams Br mf(+)S, a§; freq. Gr §&C	Rec. = 1.2 WET
			10				
			10				
			10				
					(Glaciofluvial - deltaic)		
35							
		S-8	7	SM SW	BrGr mf(+)S, a§, freq. Gr §&C seams Br cm(+)fS, t(+)§	Rec. = 1.3 WET	
			6				
			10				
			10				
					(Transitional)		
40						40.3'	
		S-9	6	CL	Gr C&§; freq. §&C s, fS seams, vvd. (Glaciolacustrine)	Rec. = 2.0 WET	
			5				
			7				
			9				
					Grout	17.0 - 0.0'	
					Bentonite	22.0 - 17.0'	
					Screen	40.0 - 25.0'	
					Sand Pack	41.0 - 22.0'	
					Bentonite	42.0 - 41.0'	
45							

(#10 Slot)

DUNN GEOSCIENCE CORPORATION LATHAM, NEW YORK (518) 783-8102				TEST BORING LOG			BORING NO. DGC-17	
PROJECT GE/Moreau							SHEET 1 OF 3	
CLIENT GE Nott Street							JOB NO. 383-5-2973	
DRILLING CONTRACTOR Warren George, Inc.							ELEVATION 329.42'	
PURPOSE Subsurface Geological Invest./Monitoring Well Install.							DATUM USGS	
GROUNDWATER				CASING	SAMPLE	CORE	DATE STARTED 8/14/84	
DATE	TIME	DEPTH	CASING	TYPE	Mud Rot.	Sp/Sp	DATE FINISHED	
				DIAMETER	4 3/4"	2"	DRILLER V. Aimar	
				WEIGHT		140#	INSPECTOR M. Ianniello/R. Sutch	
				FALL		30"		
DEPTH FT.	CASING BLOWS	SAMPLE NUMBER	BLOWS ON SAMPLE SPOON PER 6"	UNIFIED CLASSIFICATION	GRAPHIC LOG	IDENTIFICATION		REMARKS
		S-1	2	SW		DkBr cmfS, to\$; rts.	1.3'	Rec. = 1.2 Dry
			4					
			3	SW				
			3					
5		S-2	4		Br cmf S, t\$		Rec. = 1.4 WET	
			7	SW				
			9					
			9					
10		S-3	17		Brown coarse to fine SAND, trace Silt		Rec. = 1.6 WET	
			17	SW				
			18					
			19					
15		S-4	18		Br cm(+)fS, t(+) \$; freq. Dk S seams, occ. TnOr cm(+) f S seam		Rec. = 1.7 WET	
			15	SW				
			10					
			15					
20								

PROJECT GE/Moreau

SHEET 2 OF 3

CLIENT GE Nott Street

JOB NO. 383-5-2973

DEPTH FT.	CASING BLOWS	SAMPLE NUMBER	BLOWS ON SAMPLE SPOON PER 6"	UNIFIED CLASSIFICATION	GRAPHIC LOG	IDENTIFICATION	REMARKS
25		S-5	5	SM		GrBr fS, a(+)Cy\$; freq. Gr \$&C seams 21.0'	Rec. = 1.55 WET
			12				
			15				
			13				
30		S-6	21	SM		Br cm(+)fS, 1 \$; freq. Dk S seams (hydraulic sands)	Rec. = 1.1 WET
			38				
			47				
			60				
35		S-7	11	SM		Br mf(+)S, a \$; freq. pkt seams, Tn C & \$	Rec. = 1.5 WET
			15				
			18				
			14				
40		S-8	10	SM		Br mf(+) S, 1(-) \$ Brown medium to fine(+) SAND, little (-) Silt	Rec. = 1.4 WET
			17				
			16				
			17				
45		S-9	7	SM		Br cm(+)fS, 1(+) \$; occ. seam Gr, RdTn \$ & C	Rec. = 1.25 WET
			9				
			14				
			14				

DUNN GEOSCIENCE CORPORATION LATHAM, NEW YORK (518) 783-8102				TEST BORING LOG		BORING NO. DGC-17	
PROJECT GE/Moreau						SHEET 3 OF 3	
CLIENT GE Nott Street						JOB NO. 383-5-2973	
DEPTH FT.	CASING BLOWS	SAMPLE NUMBER	BLOWS ON SAMPLE SPOON PER 6"	UNIFIED CLASSIFICATION	GRAPHIC LOG	IDENTIFICATION	REMARKS
45		S-10	13	SM		Br mf(+)S, l(-)\$; freq. Gr seams C & \$, freq. Dk S seam	Rec. = 1.3 WET
			16				
			21				
			19				
50		S-11	11	SW		BrGr cm(+)fS, t(+)\$; freq. Dk S seams	Rec. = 0.8 WET
			17				
			21				
			13				
55		S-12	5	ML		DkGr \$&C, freq. C&\$ l; f S lyrs (Glaciolacustrine)	Rec. = 2.0 WET
			4				
			5				
			7				
						Well Installation:	
						Grout	24.0 - 0.0'
						Bentonite	29.0 - 24.0'
						Screen	52.0 - 32.0'
						Sand Pack	53.0 - 29.0'
						Bentonite	55.0 - 53.0'

52.5'

DUNN GEOSCIENCE CORPORATION LATHAM, NEW YORK (518) 783-8102				TEST BORING LOG			BORING NO. DGC-18	
PROJECT GE/Moreau							SHEET 1 OF 4	
CLIENT GE Nott Street							JOB NO. 383-5-2973	
DRILLING CONTRACTOR Warren George, Inc.							ELEVATION 349.98'	
PURPOSE Subsurface Geological Invest./Monitoring Well Install.							DATUM USGS	
GROUNDWATER			CASING	SAMPLE	CORE			
DATE	TIME	DEPTH	CASING	TYPE	Mud Rot.	Sp/Sp	DATE STARTED 8/15/84	
				DIAMETER	4 3/4"	2"	DATE FINISHED 8/16/84	
				WEIGHT		140#	DRILLER V. Aimar	
				FALL		30"	INSPECTOR R. Sutch/M. Iannielli	

DEPTH FT.	CASING BLOWS	SAMPLE NUMBER	BLOWS ON SAMPLE SPOON PER 6"	UNIFIED CLASSIFICATION	GRAPHIC LOG	IDENTIFICATION	REMARKS
5		S-1		SW		DkBr cmfS, to\$; rts.	Rec. = 0.6 Moist
10		S-2	7 9 12 18	SW		Br cmfS, t\$ Brown coarse to fine SAND, trace Silt	Rec. = 1.3 Dry
15		S-3	9 12 13 15	SW		Br cmf S, t\$	Rec. = 1.0 Moist
20		S-4	8 11 14 18	SW		Br cm(+)f S, t(+) \$	Rec. = 0.9 Moist

PROJECT GE/Moreau

SHEET 2 OF 4

CLIENT GE Nott Street

JOB NO. 383-5-2973

DEPTH FT.	CASING BLOWS	SAMPLE NUMBER	BLOWS ON SAMPLE SPOON PER 6"	UNIFIED CLASSIFICATION	GRAPHIC LOG	IDENTIFICATION	REMARKS
25		S-5	8	SW		Br cmf S, t\$	Rec. = 0.8 WET
			11				
			16				
			17				
30		S-6	12	SW		Br cmf(+) S, t(+)\$	Rec. = 0.7 WET
			18				
			20				
			20				
35		S-7	9	SW		Br cm(+)fS, t(+)\$	Rec. = 0.75 WET
			13				
			13				
			13				
40		S-8	14	SW		Br cm(+)fS, t(+)\$	Rec. = 1.0 WET
			15				
			23				
			23				
45		S-9	8	SW		Br cmfS, t\$	Rec. = 0.9 WET
			13				
			19				
			19				
45		S-10	16	SW		Br cm(+)fS, t\$	Rec. = 1.4 WET
			19				
			22				
			17				
45		S-11	15	SW		Br cm(+)fS, t\$	Rec. = 1.0 WET
			21				

DUNN GEOSCIENCE CORPORATION LATHAM, NEW YORK (518) 783-8102				TEST BORING LOG		BORING NO. DGC-18	
PROJECT GE/Moreau						SHEET 3 OF 4	
CLIENT GE Nott Street						JOB NO. 383-5-2973	
DEPTH FT.	CASING BLOWS	SAMPLE NUMBER	BLOWS ON SAMPLE SPOON PER 6"	UNIFIED CLASSIFICATION	GRAPHIC LOG	IDENTIFICATION	REMARKS
50			30				
			23				
		S-12	13	SW		Br cm(+)f S, t\$	Rec. = 1.2 WET
			15				
			24				
			26				
		S-13	13	SW		Br cm(+)fS, t\$; occ. Dk S seam	Rec. = 1.0 WET
			22				
			28				
			21				
	S-14	18	SW		Br cmfS, t\$	Rec. = 1.4 WET	
		21					
		20	SM		Br mf(+)S, 1(+) \$	51.6'	
		17					
	S-15	6	SM		Br cm(+)fS, 1(+) \$; occ. Gr C&\$ seam, freq. Dk S seams	Rec. = 1.1 WET	
		10					
		17					
		16					
55		S-16	11	SW		Br cmfS, t(-) \$, freq. Gr C&S pkt.	Rec. = 1.5 WET
			14				
			8				
			12				
		S-17	8	SW		Br cmfS, t(+) \$; occ. Gr C&\$ seams	Rec. = 1.0 WET
			10				
	18						
		22				58.0'	
60		S-18	12	SW		BrGr cm(+)fS, t(+) \$ (Transitional Zone)	Rec. = 0.9 WET
			14				
			20				
			20				
	S-19	6	SM		GrBr cm(+)fS, s\$	Rec. = 0.9 WET	
		10					
		14					
		14					
	S-20	10	SM		Gr cm(+)fS, s\$; occ. \$yC seam	Rec. = 1.7 WET	
		10					
		16					
		16					
65		S-21	8	SW		Br cmfS, t\$	Rec. = 1.0 WET
			13				
			25				
			25	SM		Gr cm(+)fS, 1(-) \$	65.15'
			26				
			30				
	S-22	26	SW		BrGr cmfS, t(+) \$; freq. pkt Gr \$&C	Rec. = 0.8 WET	
		30					
		48					
		31					
70		S-23	6	SM		Gr mf(+)S, s(+) \$; freq. DkGr C&\$ seams	Rec. = 1.2 WET
			5				
			8				
			14				

PROJECT GE/Moreau

SHEET 4 OF 4

CLIENT GE Nott Street

JOB NO. 383-5-2973

DEPTH FT.	CASING BLOWS	SAMPLE NUMBER	BLOWS ON SAMPLE SPOON PER 6"	UNIFIED CLASSIFICATION	GRAPHIC LOG	IDENTIFICATION	REMARKS
75		S-24	21	SM		GrBr cmf(+)S, s\$	Rec. = 0.3 WET
			12				
			22				
			26				
		S-25	14	SW		GrBr cm(+)fS, t(+)\$; occ. DkGr C&\$ seam, freq. Dk S seams	Rec. = 0.9 WET
			18				
			22				
			28				
		S-26	20	SM		GrBr cm(+)fS, l(+)\$; freq. pkt. DkGr C&\$	Rec. = 1.3 WET
			23				
			30				
			30				
	S-27	20	ML	Same	77.45'	Rec. = 1.3 WET	
		22					
		20					
		19					
80		S-28	15	CL	DkGr\$&C s(-), fS, a(+) \$; vvd. (Glaciolacustrine) DkGr \$yC s(-), fS, a\$; vvd.	79.0'	Rec. = 1.7 WET
			21				
			26				
			23				
85						End of Boring @ 79.0'	
						Well Installation	
						Grout	50.0 - 0.0'
						Bentonite	55.0 - 50.0'
						Screen	77.0 - 57.0' (#10 slot)
						Sand Pack	78.0 - 55.0' (#1/2 sand)
						Bentonite	79.0 - 78.0'

DUNN GEOSCIENCE CORPORATION LATHAM, NEW YORK (518) 783-8102				TEST BORING LOG			BORING NO. DGC-18I	
PROJECT GE/Moreau							SHEET 1 OF 1	
CLIENT GE Nott Street							JOB NO. 383-5-2973	
DRILLING CONTRACTOR Warren George, Inc.							ELEVATION 349.49'	
PURPOSE Subsurface Geologic Invest./Monitoring Well Install.							DATUM USGS	
GROUNDWATER				CASING	SAMPLE	CORE	DATE STARTED 8/16/84	
DATE	TIME	DEPTH	CASING	TYPE	Mud Rot.	Sp/Sp	DATE FINISHED 8/17/84	
				DIAMETER	4 3/4"	2"	DRILLER V. Aimar	
				WEIGHT		140#	INSPECTOR R. Sutch/M. Ianniello	
				FALL		30"		

DEPTH FT.	CASING BLOWS	SAMPLE NUMBER	BLOWS ON SAMPLE SPOON PER 6"	UNIFIED CLASSIFICATION	GRAPHIC LOG	IDENTIFICATION	REMARKS
39		S-1	15	SW		Br cmfS, t\$	Rec. = .35 WET
			24				
			23				
41			20				
						Brown coarse to fine SAND, trace Silt	
						Grout 29.0 - 0.0'	
						Bentonite 34.0 - 29.0'	
						Screen 57.0 - 37.0' (10 slot)	
						Sand 59.0 - 34.0' (Mortle 1)	
						Bentonite 60.0 - 59.0'	

DUNN GEOSCIENCE CORPORATION LATHAM, NEW YORK (518) 783-8102	TEST BORING LOG	BORING NO. DGC-19S
---	------------------------	------------------------------

PROJECT GE/Moreau	SHEET 1 OF 3
--------------------------	---------------------

CLIENT GE Nott Street	JOB NO. 383-5-2973
------------------------------	---------------------------

DRILLING CONTRACTOR Warren George, Inc.	ELEVATION 359.49'
--	--------------------------

PURPOSE Subsurface Geologic Invest./Monitoring Well Install.	DATUM USGS
---	-------------------

GROUNDWATER	CASING Mud Rot.	SAMPLE Sp/Sp	CORE	DATE STARTED 8/20/84
--------------------	------------------------	---------------------	-------------	-----------------------------

DATE	TIME	DEPTH	CASING	TYPE	DIAMETER 4 3/4"	2"	DATE FINISHED 8/20/84
-------------	-------------	--------------	---------------	-------------	------------------------	-----------	------------------------------

				WEIGHT		140#	DRILLER V. Aimar
--	--	--	--	---------------	--	------	-------------------------

				FALL		30"	INSPECTOR R. Sutch/M. Ianniello
--	--	--	--	-------------	--	-----	--

DEPTH FT.	CASING BLOWS	SAMPLE NUMBER	BLOWS ON SAMPLE SPOON PER 6"	UNIFIED CLASSIFICATION	GRAPHIC LOG	IDENTIFICATION	REMARKS
5		S-1	2	SW		BrTn cmfS, t\$	Rec. = 1.2 Dry
			3				
			3				
			4				
5		S-2	8	SW		Br cmfS, t(+)\$	Rec. = 0.7 Dry
			11				
			16				
			21				
10		S-3	10	SM		Br cmfS, 1\$	Rec. = 1.0 Moist
			11				
			18				
			21				
15		S-4	9	SW		Br cmfS, t(+)\$; freq. Bk S seams	Rec. = 1.0 Moist
			19				
			21				
			21				
20							

PROJECT GE/Moreau

SHEET 2 OF 3

CLIENT GE Nott Street

JOB NO. 383-5-2973

DEPTH FT.	CASING BLOWS	SAMPLE NUMBER	BLOWS ON SAMPLE SPOON PER 6"	UNIFIED CLASSIFICATION	GRAPHIC LOG	IDENTIFICATION	REMARKS
20		S-5	10	SW		BrGr c(+)mfS, t(+)\$, t(+)mfG	Rec. = 0.9 WET
			13				
			19				
			19				
25		S-6	14	SW		BrGr c(+)mfS, t(+)\$, t mfG	Rec. = 0.8 WET
			16				
			24				
			25				
30						<u>Brown gray coarse (+) medium fine SAND, trace Silt, trace medium to fine Gravel</u>	
35		S-7	10	SW		Br c(+)mfS, t\$, t mfG	Rec. = 1.0 WET
			16				
			27				
			28				
40		S-8	17	SW		Br c(+)mfS, t\$, t(-) fG	Rec. = 0.7 WET
			23				
			25				
			26				
45		S-9	4	SW		Br cmfS, t(-)\$, t(-) fG	Rec. = 0.8 WET
			3				
			6				
			8				
						43.0'	
						End of Boring @ 43.0'	

DUNN GEOSCIENCE CORPORATION LATHAM, NEW YORK (518) 783-8102	TEST BORING LOG	BORING NO. DGC-20
---	------------------------	-----------------------------

PROJECT GE/Moreau	SHEET 1 OF 5
--------------------------	---------------------

CLIENT GE Nott Street	JOB NO. 383-5-2973
------------------------------	---------------------------

DRILLING CONTRACTOR Warren George, Inc.	ELEVATION 341.34'
--	--------------------------

PURPOSE Subsurface Geologic Invest./Monitoring Well Install.	DATUM USGS
---	-------------------

GROUNDWATER				CASING	SAMPLE	CORE	DATUM	USGS
DATE	TIME	DEPTH	CASING	TYPE	Mud Rot.	Sp/Sp	DATE STARTED	8/21/84
				DIAMETER	4 3/4"	2"	DATE FINISHED	8/21/84
				WEIGHT		140#	DRILLER	V. Aimar
				FALL		30"	INSPECTOR	M. Ianniello

DEPTH FT.	CASING BLOWS	SAMPLE NUMBER	BLOWS ON SAMPLE SPOON PER 6"	UNIFIED CLASSIFICATION	GRAPHIC LOG	IDENTIFICATION	REMARKS
5		S-1	6			DkBr cmf(+)S, a(+) O\$; rts. BrOr cmfS, 1\$; rts.	Rec. = 1.2 Dry
			10				
			10				
			13				
10		S-2	6			Br cmf(+)S, 1\$; rts. Brown coarse to fine SAND, little Silt	Rec. = 1.0 Moist
			10				
			13				
			15				
15		S-3	8			LtBrGr c(+) mfS, t(+)\$, t(+) mfG	Rec. = 0.7 Moist
			8				
			10				
			12				
20		S-4	10			Same	Rec. = 0.7 Moist
			13				
			15				
			14				

DUNN GEOSCIENCE CORPORATION
LATHAM, NEW YORK (518) 783-8102

TEST BORING LOG

BORING NO. DGC-20

PROJECT GE/Moreau

SHEET 2 OF 5

CLIENT GE Nott Street

JOB NO. 383-5-2973

DEPTH FT.	CASING BLOWS	SAMPLE NUMBER	BLOWS ON SAMPLE SPOON PER 6"	UNIFIED CLASSIFICATION	GRAPHIC LOG	IDENTIFICATION	REMARKS
20		S-5	8			Br c(+)mfS, t\$, t(+)mfG	Rec. = 0.9 WET
			11				
			15				
			15				
25		S-6	17		Br c(+)mfS, t\$, t mfG	Rec. = 1.0 WET	
			22				
			33				
			28				
30		S-7	10		Br c(+)mfS, t\$, t mfG	Rec. = 1.0 WET	
			15				
			20				
			17				
35		S-8	13		Br c(+)mfS, t(+)\$, t mfG	Rec. = 1.1 WET	
			18				
			24				
			21				
40		S-9	10		Br c(+)mfS, t\$	Rec. = 0.9 WET	
			12				
			12				
			13				
45							

PROJECT GE/Moreau

SHEET 3 OF 5

CLIENT GE Nott Street

JOB NO. 383-5-2973

DEPTH FT.	CASING BLOWS	SAMPLE NUMBER	BLOWS ON SAMPLE SPOON PER 6"	UNIFIED CLASSIFICATION	GRAPHIC LOG	IDENTIFICATION	REMARKS
45		S-10	12			Br mf(+)S, 1(-)\$	Rec. = 1.0 WET
			13				
			30				
			30				
50		S-11	15		BrGr mf(+)S, 1(+)\$	Rec. = 1.5 WET	
			21				
			22				
			21				
55		S-12	14		Brown gray medium to fine(+) SAND, little(+) Silt	BrGr mf(+)S, 1(+)\$	Rec. = 1.2 WET
			16				
			24				
			32				
60		S-13	10		BrGr mfS, 1\$	Rec. = 1.0 WET	
			14				
			19				
			21				
65		S-14	24		BrGr cmfS, t(+)\$	Rec. = 1.2 WET	
			32				
			32				
			39				
70							

PROJECT GE/Moreau

SHEET 4 OF 5

CLIENT GE Nott Street

JOB NO. 383-5-2973

DEPTH FT.	CASING BLOWS	SAMPLE NUMBER	BLOWS ON SAMPLE SPOON PER 6"	UNIFIED CLASSIFICATION	GRAPHIC LOG	IDENTIFICATION	REMARKS
75		S-15	14			GrBr mf(+)S, l(+)\$, t mfG; occ. Cy\$ seam	Rec. = 1.2 WET
			18				
			25				
			26				
80		S-16	22			Gr m(+)fS, l\$; freq. DkGr S seams	Rec. = 1.0 WET
			48				
			105/6"				
85		S-17	16			BrGr mfS, l\$; freq. Bk S seams 80.5' BrGr mf(+)S, s(+)\$	Rec. = 1.0 WET
			22				
			37				
			30				
90		S-18	12			Br fS, s\$; occ. Cy\$ seams	Rec. = 1.2 WET
			13				
			26				
			25				
95		S-19	14			Gr mfs, a\$	Rec. = 1.2 WET
			20				
			31				
			34				
						83.0'	(Transitional Zone)

PROJECT GE/Moreau

SHEET 5 OF 5

CLIENT GE Nott Street

JOB NO. 383-5-2973

DEPTH FT.	CASING BLOWS	SAMPLE NUMBER	BLOWS ON SAMPLE SPOON PER 6"	UNIFIED CLASSIFICATION	GRAPHIC LOG	IDENTIFICATION	REMARKS
100		S-20	18			Gr mf(+)S, s\$	Rec. = 0.9 WET
			24				
			35				
			33				
105		S-21	17			Gr mf(+)S, s(+)\$; occ. DkGr C&\$ lyr.	Rec. = 1.5 WET
			22				
			48				
			52				
						105.0'	
110		S-22	26			DkGr \$&C 1, fS; freq. C&\$ seams; vvd. (Glaciolacustrine)	Rec. = 1.7 WET
			26				
			31				
			28				
115		S-23	4			DkGr C&\$ s, fS; freq. \$&C lys, vvd.	Rec. = 2.0 WET
			10				
			15				
			14				
Well Installation							
Bentonite						108.0 - 107.0'	(# $\frac{1}{2}$) (#10 slot)
Sand						107.0 - 72.0'	
Screen						105.0 - 75.0'	
Bentonite						72.0 - 67.0'	
Grout						67.0 - 0.0'	

DUNN GEOSCIENCE CORPORATION LATHAM, NEW YORK (518) 783-8102					TEST BORING LOG			BORING NO. DGC-20S	
PROJECT GE/Moreau								SHEET 1 OF 1	
CLIENT GE Nott Street								JOB NO. 383-5-2973	
DRILLING CONTRACTOR Warren George, Inc.								ELEVATION 341.63'	
PURPOSE Subsurface Geologic Invest./Monitoring Well Install.								DATUM USGS	
GROUNDWATER					CASING	SAMPLE	CORE		
DATE	TIME	DEPTH	CASING	TYPE	None	None		DATE STARTED	8/23/84
				DIAMETER				DATE FINISHED	8/23/84
				WEIGHT				DRILLER	V. Aimar
				FALL				INSPECTOR	M. Ianniello
DEPTH FT.	CASING BLOWS	SAMPLE NUMBER	BLOWS ON SAMPLE SPOON PER 6"	UNIFIED CLASSIFICATION	GRAPHIC LOG	IDENTIFICATION			REMARKS
						End of Boring @ 58.0'			
						Well Installation			
						Grout	8.0 - 0.0'		
						Bentonite	13.0 - 8.0'		
						Screen	55.0 - 15.0'		(#20 slot)
						Sand Pack	57.0 - 13.0'		(#1)
						Bentonite	58.0 - 57.0'		

DUNN GEOSCIENCE CORPORATION LATHAM, NEW YORK (518) 783-8102				TEST BORING LOG			BORING NO. DGC-21	
PROJECT GE/Moreau							SHEET 1 OF 5	
CLIENT GE Nott Street							JOB NO. 383-5-2973	
DRILLING CONTRACTOR Warren George, Inc.							ELEVATION 339.05'	
PURPOSE Subsurface Geologic Invest./Monitoring Well Install.							DATUM USGS	
GROUNDWATER				CASING	SAMPLE	CORE		
DATE	TIME	DEPTH	CASING	TYPE	Mud Rot.	Sp/Sp	DATE STARTED 8/24/84	
				DIAMETER	4 3/4"	2"	DATE FINISHED 8/27/84	
				WEIGHT		140#	DRILLER V. Aimar	
				FALL		30"	INSPECTOR R. Sutch/M. Ianniello	

DEPTH FT.	CASING BLOWS	SAMPLE NUMBER	BLOWS ON SAMPLE SPOON PER 6"	UNIFIED CLASSIFICATION	GRAPHIC LOG	IDENTIFICATION	REMARKS
5		S-1	2	SM		BkBr cmfS, so\$; (humus)	.5' Rec. = 1.4 Dry
			3				
			2				
			2				
10		S-2	4	SM		BrGr cm(+)fS, 1(+)o\$	Rec. = 1.5 Moist
			6				
			8				
			7				
15		S-3	11	SW		Br c(+)mfS, t\$, t mfG	Rec. = 1.0 Moist
			15				
			18				
			19				
20		S-4	8	SM		BrGr c(+)mfS, t o\$	Rec. = 0.8 Moist-WET
			9				
			12				
			11				

Brown coarse(+) to medium fine SAND, trace Silt, trace medium to fine Gravel

PROJECT GE/Moreau

SHEET 2 OF 5

CLIENT GE Nott Street

JOB NO. 383-5-2973

DEPTH FT.	CASING BLOWS	SAMPLE NUMBER	BLOWS ON SAMPLE SPOON PER 6"	UNIFIED CLASSIFICATION	GRAPHIC LOG	IDENTIFICATION	REMARKS
20		S-5	5	SW		Br c(+)mfS, t\$, tfG	Rec. = 0.8 WET
			6				
			10				
			10				
25		S-6	9	SW		BrGr c(+)mfS, t(-)\$, 1 mfG	Rec. = 1.2 WET
			5				
			12				
			12				
30		S-7	4	SW		BrGr c(+)mfS, t\$	Rec. = 0.8 WET
			8				
			10				
			9				
35		S-8	13	SW		BrGr cmfS, t\$	Rec. = 0.9 WET
			20				
			22				
			20				
40		S-9	5	SW		BrGr cmfS, t\$, t mf(+)G	Rec. = 0.8 WET
			7				
			9				
			7				
45							

DUNN GEOSCIENCE CORPORATION LATHAM, NEW YORK (518) 783-8102				TEST BORING LOG		BORING NO. DGC-21	
PROJECT GE/Moreau						SHEET 3 OF 5	
CLIENT GE Nott Street						JOB NO. 383-5-2973	
DEPTH FT.	CASING BLOWS	SAMPLE NUMBER	BLOWS ON SAMPLE SPOON PER 6"	UNIFIED CLASSIFICATION	GRAPHIC LOG	IDENTIFICATION	REMARKS
50		S-10	10	SW		BrGr cm(+)fS, t(+)\$, t mfG	Rec. = 1.0 WET
			17				
			18				
			31				
55		S-11	6	SW		Br cm(+)fS, t\$, tfG; occ. Dk S seam	Rec. = 0.8 WET
			9				
			9				
			9				
60		S-12	11	SW		BrGr cmfS, t(+)\$, t mfG; alt. Bk & Tn S seam	Rec. = 0.8 WET
			15				
			22				
			27				
65		S-13	30	SW		Br cmfS, t(+)\$	Rec. = 1.0 WET
			37				
			41				
			30				
70		S-14	14	SW		Br c(+)mfS, t\$	Rec. = 1.0 WET
			22	SM			
			30				
			36				
						<u>Brown coarse to fine SAND, trace(+)</u> <u>Silt</u>	
						66.6'	

DUNN GEOSCIENCE CORPORATION LATHAM, NEW YORK (518) 783-8102			TEST BORING LOG		BORING NO. DGC-21		
PROJECT GE/Moreau					SHEET 4 OF 5		
CLIENT GE Nott Street					JOB NO. 383-5-2973		
DEPTH FT.	CASING BLOWS	SAMPLE NUMBER	BLOWS ON SAMPLE SPOON PER 6"	UNIFIED CLASSIFICATION	GRAPHIC LOG	IDENTIFICATION	REMARKS
75		S-15	23	SW		GrBr cm(+)fS, t\$; freq. Dk S seam; occ. fS, s\$ lyr.	Rec. = 1.2 WET
			20				
			33				
			28				
80		S-16	19	SM		Gr mf(+)S, s(-)\$; freq. DkGr fS seams	Rec. = 1.3 WET
			36				
			46				
			34				
85		S-17	14	SW		BrGr cmfS, t\$	Rec. = 1.1 WET
			25				
			29				
			32				
90		S-18	16	SM	T- Zone	BrGr cmfS, l\$	Rec. = 1.0 WET
			28				
			39	SM			
			33				
95		S-19	7	SM		Gr fS, a\$; occ. S&C seam (Wood Fragments)	Rec. = 1.1
			13				
			27				
			31				
						Shelby Tube Attempted - No recovery	

86.4'

DUNN GEOSCIENCE CORPORATION
LATHAM, NEW YORK (518) 783-8102

TEST BORING LOG

BORING NO. DGC-21

PROJECT GE/Moreau

SHEET 5 OF 5

CLIENT GE Nott Street

JOB NO. 383-5-2973

DEPTH FT.	CASING BLOWS	SAMPLE NUMBER	BLOWS ON SAMPLE SPOON PER 6"	UNIFIED CLASSIFICATION	GRAPHIC LOG	IDENTIFICATION	REMARKS
95		S-20	16	SM		Gr mf(+)S, s(-)\$; freq. DkGr fs seams	Rec. = 0.8 WET
			30				
			38				
			35				
100		S-21	13	SM		Gr mf(+)S, s(+)\$	Rec. = 0.8 WET
			12				
			16				
			30				
105		S-22	7	SM		DkGr S&C, a fs; freq. C&\$ seams (Glaciolacustrine)	Rec. = 2.0 WET
			11				
			15				
			23				
110		S-23				Well Installation Bentonite 105.0 - 104.0' Sand 104.0 - 67.0' Screen 103.0 - 70.0' Bentonite 67.0 - 62.0' Grout 62.0 - 0.0'	(#1/2) (#10)
115		S-24					
120							

DUNN GEOSCIENCE CORPORATION LATHAM, NEW YORK (518) 783-8102				TEST BORING LOG			BORING NO. DGC-21S	
PROJECT GE/Moreau							SHEET 1 OF 1	
CLIENT GE Nott Street							JOB NO. 383-5-2973	
DRILLING CONTRACTOR Warren George, Inc.							ELEVATION 339.03'	
PURPOSE Subsurface Geologic Invest./Monitoring Well Install.							DATE STARTED 8/28/84	
GROUNDWATER				CASING	SAMPLE	CORE	DATUM USGS	
DATE	TIME	DEPTH	CASING	TYPE	Mud Rot.	Sp/Sp	DATE FINISHED 8/28/84	
				DIAMETER	4 3/4"	2"	DRILLER V. Aimar	
				WEIGHT		140#	INSPECTORM. Ianniello	
				FALL		30"		
DEPTH FT.	CASING BLOWS	SAMPLE NUMBER	BLOWS ON SAMPLE SPOON PER 6"	UNIFIED CLASSIFICATION	GRAPHIC LOG	IDENTIFICATION		REMARKS
						End of Boring @ 38.0'		
						Well Installation		
						Bentonite 38.0 - 37.0'		
						Sand 37.0 - 12.0'		
						Screen 35.0 - 15.0'		
						Bentonite 12.0 - 7.0'		
						Grout 7.0 - 0.0'		
						Stickup 2.5		

DUNN GEOSCIENCE CORPORATION LATHAM, NEW YORK (518) 783-8102				TEST BORING LOG			BORING NO. DGC-22	
PROJECT GE/Moreau							SHEET 1 OF 4	
CLIENT GE Nott Street							JOB NO. 383-5-2973	
DRILLING CONTRACTOR Warren George, Inc.							ELEVATION 335.0'	
PURPOSE Subsurface Geologic Invest./Monitoring Well Install.							DATE STARTED 8/29/84	
GROUNDWATER				CASING	SAMPLE	CORE	DATUM USGS	
DATE	TIME	DEPTH	CASING	TYPE	Mud Rot.	Sp/Sp	DATE FINISHED 8/29/84	
				DIAMETER	4 3/4"	2"	DRILLER V. Aimar	
				WEIGHT		140#	INSPECTOR M. Ianniello	
				FALL		30"		
DEPTH FT.	CASING BLOWS	SAMPLE NUMBER	BLOWS ON SAMPLE SPOON PER 6"	UNIFIED CLASSIFICATION	GRAPHIC LOG	IDENTIFICATION		REMARKS
5		S-1	2	SM		Bk cm(+)fS, 1(-) o\$ (Humus)	.3'	Rec. = 0.8 Dry
			2					
			2					
			3					
10		S-2	4	SW		GrBr c(+)mfS, t(+) \$		Rec. = 1.0 Dry
			7					
			9					
			9					
15		S-3	5	SW		GrBr c(+)mfS, t(+) \$		Rec. = 1.0 Dry
			8					
			11					
			11					
20		S-4	7	SW		GrBr c(+)mfS, t(+) \$		Rec. = 0.8 Moist
			8					
			13					
			12					

PROJECT GE/Moreau

SHEET 2 OF 4

CLIENT GE Nott Street

JOB NO. 383-5-2973

DEPTH FT.	CASING BLOWS	SAMPLE NUMBER	BLOWS ON SAMPLE SPOON PER 6"	UNIFIED CLASSIFICATION	GRAPHIC LOG	IDENTIFICATION	REMARKS
25		S-5	8	SM		Br cm(+)fS, 1\$	Rec. = 0.9 Moist
			11				
			15				
			14				
30		S-6	8	SW		Br cm(+)fS, 1(+)\$	Rec. = 0.8 Moist
			12				
			15				
			15				
35		S-7	10	SM		BrGr cm(+)fS, 1(-)\$, tfG; occ. fS, s\$ lyr.	Rec. = 0.8 Moist
			12				
			14				
			12				
40		S-8	8	SM		Br cm(+)fS, 1(+)\$; freq. Bk S seams	Rec. = 1.5 WET
			12				
			17				
			15				
45		S-9	10	SW		BrBr cm(+)fS, t(+)\$; freq. Bk S seams	Rec. = 0.8 WET
			13				
			25				
			25				

DUNN GEOSCIENCE CORPORATION
LATHAM, NEW YORK (518) 783-8102

TEST BORING LOG

BORING NO. DGC-22

PROJECT GE/Moreau

SHEET 3 OF 4

CLIENT GE Nott Street

JOB NO. 383-5-2973

DEPTH FT.	CASING BLOWS	SAMPLE NUMBER	BLOWS ON SAMPLE SPOON PER 6"	UNIFIED CLASSIFICATION	GRAPHIC LOG	IDENTIFICATION	REMARKS
50		S-10	8	SM		LtGr fS, a Cy\$; occ. C&\$ seam	Rec. = 1.2 WET
			11				
			19				
			20				
55		S-11	8	SM		Gr mfS, l\$; freq. Bk S seams	Rec. = 1.1 WET
			13				
			18				
			24				
60		S-12	13	SM		Gr fS a, s\$; freq. Bk S seams (Glacio-fluvial Deltaic)	Rec. = 1.4 WET
			19				
			20				
			19				
65		S-13	9	SM		Gr fS, s(-)\$; occ. C&\$ seam	Rec. = 1.1 WET
			11				
			17				
			14				
70		S-14	14	SM		Gr fS, a\$; freq. C&\$ seams	Rec. = 1.0 WET
			26				
			21				
			33				
						63.0'	(Transitional Zone)

DEPTH FT.	CASING BLOWS	SAMPLE NUMBER	BLOWS ON SAMPLE SPOON PER 6"	UNIFIED CLASSI- FICATION	GRAPHIC LOG	IDENTIFICATION	REMARKS
75		S-15	14	SM		Gr cmf(+)S, s(-)\$; freq. Dk S seam	Rec. = 1.0 WET
			26				
			41				
			24				
77.0'							
80		S-16	4	ML		Gr C&\$ 1, fS; freq. \$&C seams (Glaciolacustrine)	Rec. = 2.0 WET
			9				
			15				
			17				
85						End of Boring @ 77.0'	
						Well Installation	
						Bentonite	77.0 - 76.0'
						Sand (#½)	76.0 - 52.0'
						Screen	74.0 - 54.0'
						Bentonite	54.0 - 49.0'
						Grout	49.0 - 0.0'
						Stickup	2.0

70

DUNN GEOSCIENCE CORPORATION LATHAM, NEW YORK (518) 783-8102				TEST BORING LOG			BORING NO. DGC-22I	
PROJECT GE/Moreau							SHEET 1 OF 1	
CLIENT GE Nott Street							JOB NO. 383-5-2973	
DRILLING CONTRACTOR Warren George, Inc.							ELEVATION 335.12'	
PURPOSE Subsurface Geologic Invest./Monitoring Well Install.							DATUM USGS	
GROUNDWATER				CASING	SAMPLE	CORE	DATE STARTED 8/30/84	
DATE	TIME	DEPTH	CASING	TYPE	Mud Rot.	Sp/Sp	DATE FINISHED 8/30/84	
				DIAMETER	4 3/4"	2"	DRILLER V. Aimar	
				WEIGHT		140#	INSPECTOR M. Ianniello	
				FALL		30"		
DEPTH FT.	CASING BLOWS	SAMPLE NUMBER	BLOWS ON SAMPLE SPOON PER 6"	UNIFIED CLASSIFICATION	GRAPHIC LOG	IDENTIFICATION		REMARKS
						End of Boring @ 57.0'		
						Well Installation		
						Bentonite 57.0 - 56.0'		
						Sand (#1) 56.0 - 31.0'		
						Screen (20 slot) 54.0 - 34.0'		
						Bentonite 31.0 - 26.0'		

DUNN GEOSCIENCE CORPORATION LATHAM, NEW YORK (518) 783-8102				TEST BORING LOG			BORING NO. DGC-22S	
PROJECT GE/Moreau							SHEET 1 OF 1	
CLIENT GE Nott Street							JOB NO. 383-5-2973	
DRILLING CONTRACTOR Warren George, Inc.							ELEVATION 335.11'	
PURPOSE Subsurface Geologic Invest./Monitoring Well Install.							DATUM USGS	
GROUNDWATER				CASING	SAMPLE	CORE	DATE STARTED 8/30/84	
DATE	TIME	DEPTH	CASING	TYPE	Mud Rot.	Sp/Sp	DATE FINISHED 8/30/84	
				DIAMETER	4 3/4"	2"	DRILLER V. Aimar	
				WEIGHT		140#	INSPECTOR M. Ianniello	
				FALL		30"		
DEPTH FT.	CASING BLOWS	SAMPLE NUMBER	BLOWS ON SAMPLE SPOON PER 6"	UNIFIED CLASSI- FICATION	GRAPHIC LOG	IDENTIFICATION		REMARKS
						End of Boring @ 37.0'		
						Well Installation		
						Bentonite	37.0 - 36.0'	
						Sand (#1)	36.0 - 12.0'	
						Screen (#20)	34.0 - 14.0'	
						Bentonite	14.0 - 9.0'	
						Grout	9.0 - 0.0'	
						Stickup	2.5	

**MONITORING WELL CONSTRUCTION DETAIL
 REMEDIAL INVESTIGATION
 GENERAL ELECTRIC - MOREAU SITE
 Index Number II-CERCLA - 30201**



Date Drilled 5/16/84 - 5/18/84
 Driller J. McErlean/R. Gregory
 DGC Geologist M. Ianniello/J. Uruskyj
 Site Number DGC-1

Total Depths:
 Shallow Well 35 ft.
 Intermediate Well 53.1 ft.
 Deep Well 78 ft.

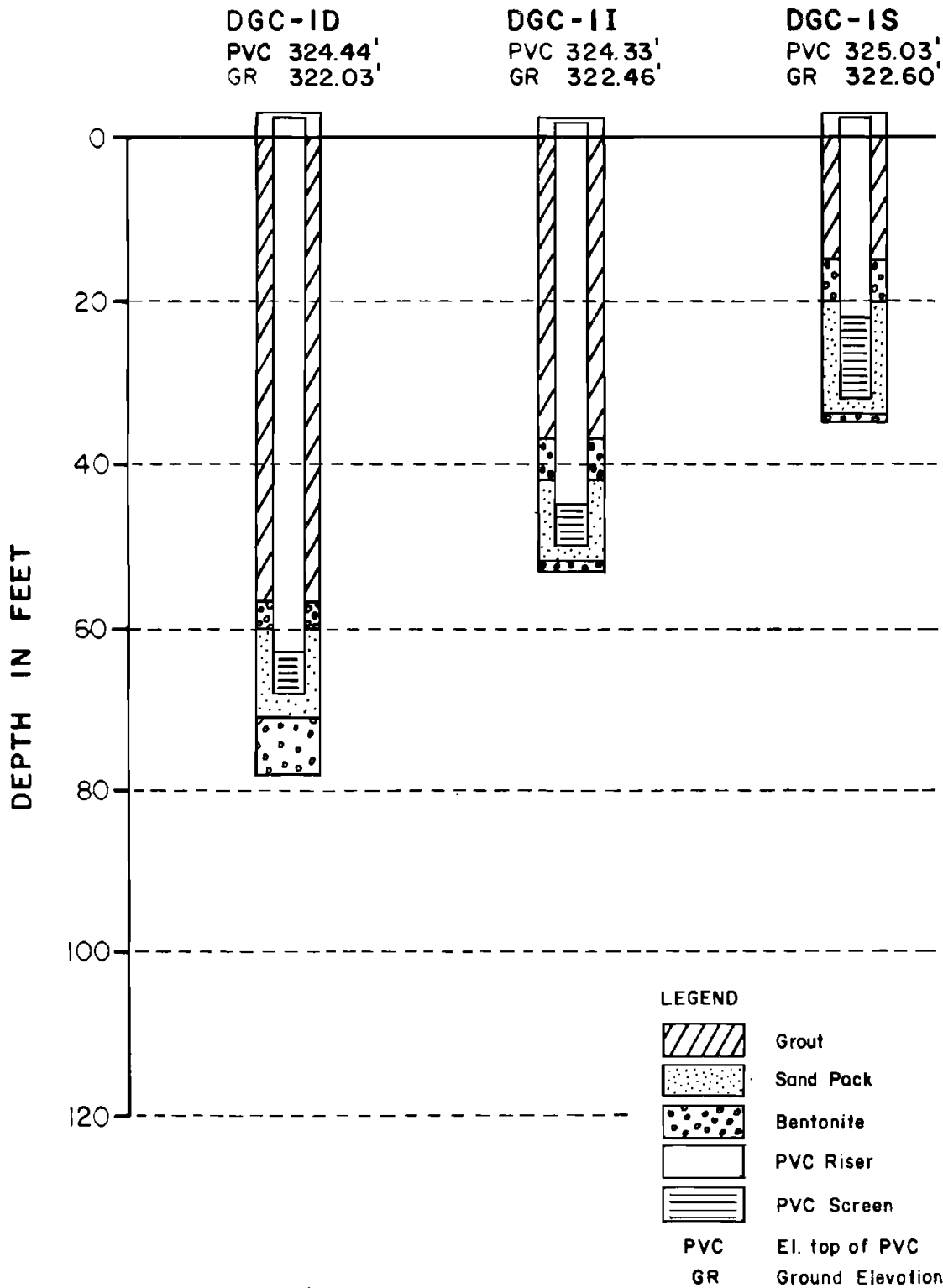

**MONITORING WELL CONSTRUCTION DETAIL
 REMEDIAL INVESTIGATION
 GENERAL ELECTRIC - MOREAU SITE
 Index Number 11-CERCLA-30201**



Date Drilled 5/8/84 - 5/17/84
 Driller R. Gregory/V. Aimar
 DGC Geologist M. Ianniello/J. Uruskyj
 Site Number DGC-2

Total Depths:
 Shallow Well 31 ft.
 Intermediate Well 49 ft.
 Deep Well 78 ft.

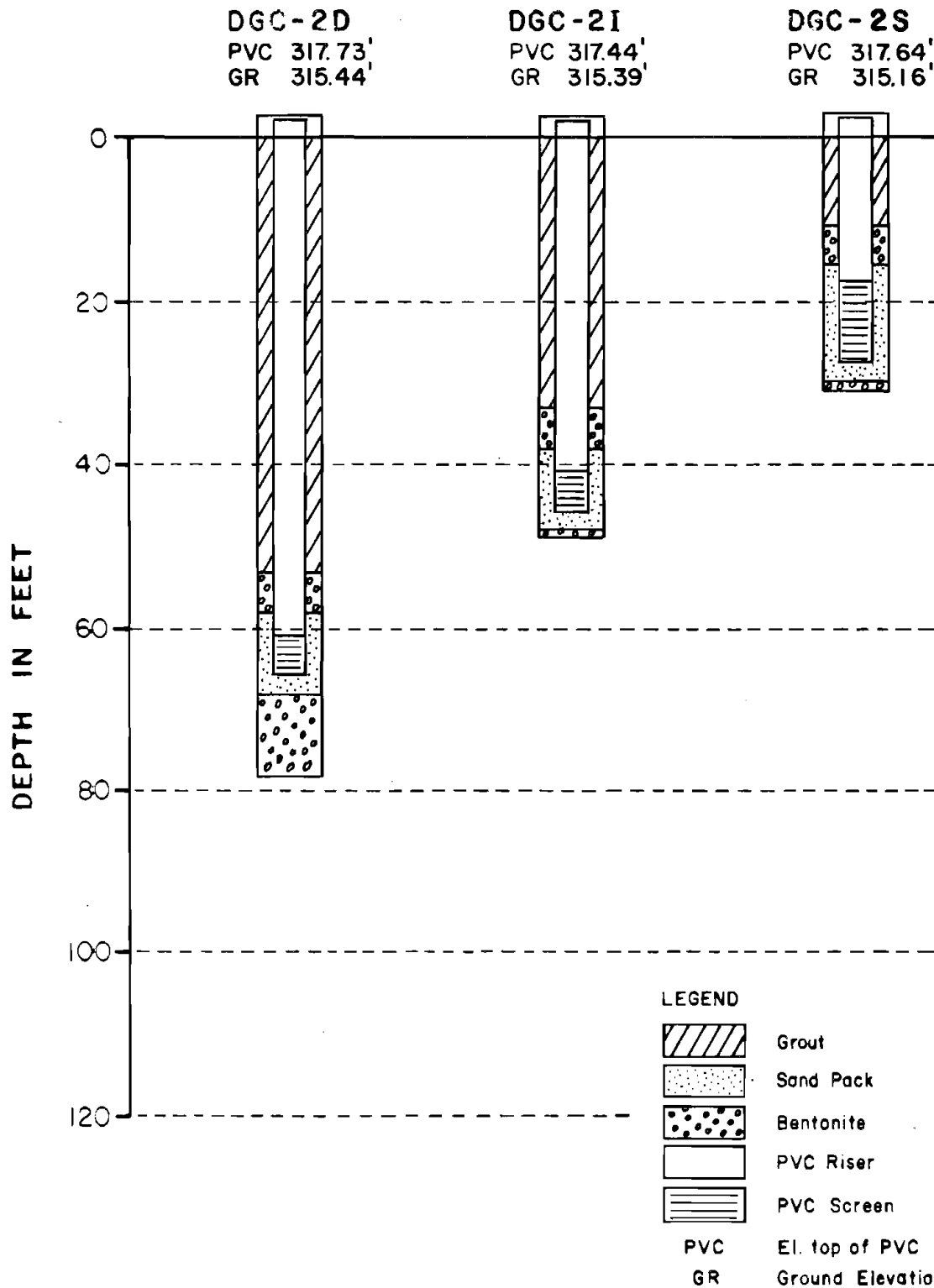

**MONITORING WELL CONSTRUCTION DETAIL
 REMEDIAL INVESTIGATION
 GENERAL ELECTRIC - MOREAU SITE
 Index Number II-CERCLA-30201**



Date Drilled 5/10/84 - 5/16/84
 Driller R. Gregory
 DGC Geologist M. Ianniello
 Site Number DGC-3

Total Depths:
 Shallow Well 33 ft.
 Intermediate Well 51 ft.
 Deep Well 67 ft.

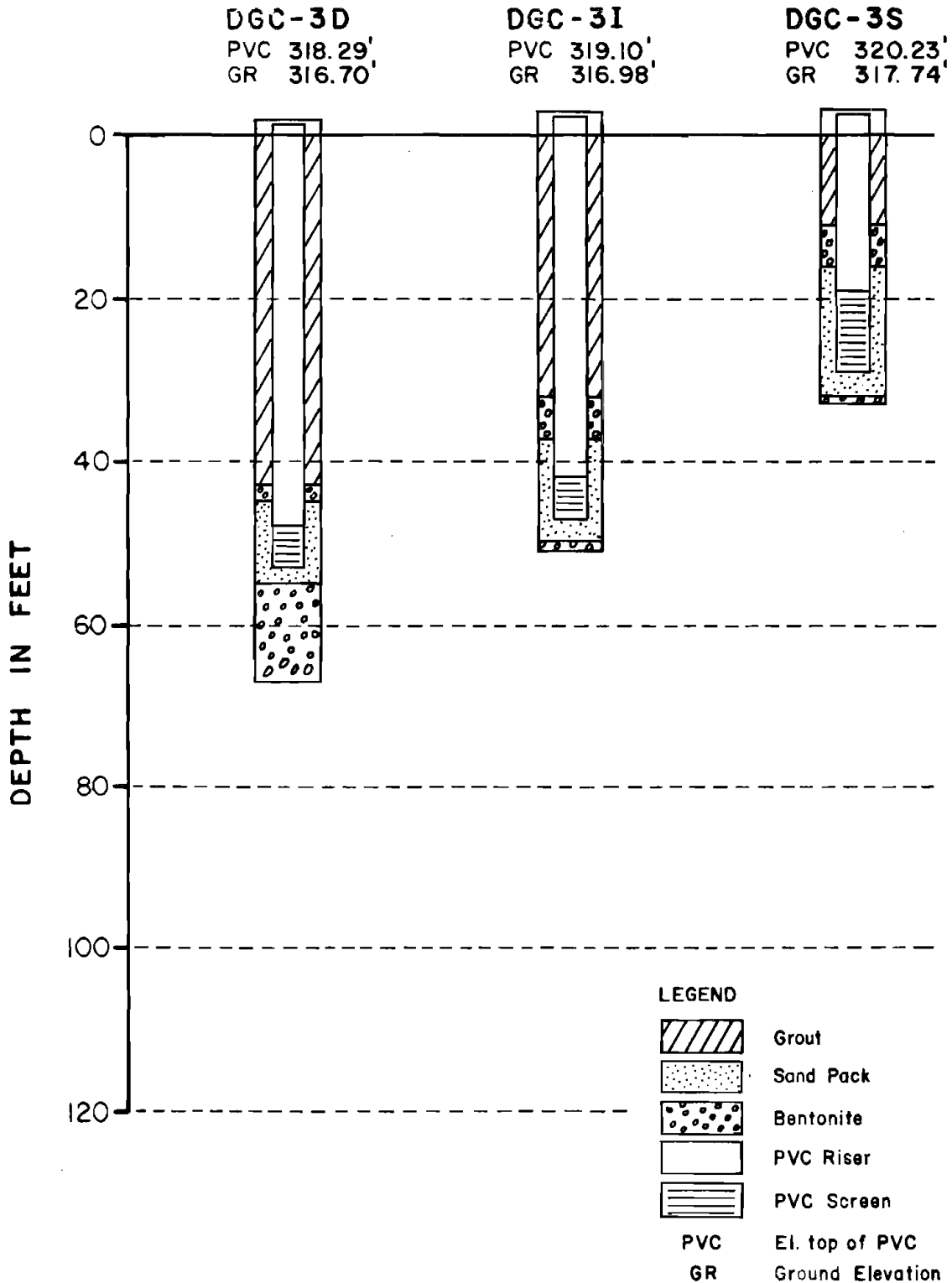

**MONITORING WELL CONSTRUCTION DETAIL
 REMEDIAL INVESTIGATION
 GENERAL ELECTRIC - MOREAU SITE
 Index Number II-CERCLA-30201**



Date Drilled 4/17/84 - 5/22/84
 Driller V. Aimar
 DGC Geologist M. Ianniello/J. Uruskyj/J. Wink
 Site Number DGC-4

Total Depths:
 Shallow Well 32 ft.
 Intermediate Well 38 ft.
 Deep Well 62 ft.

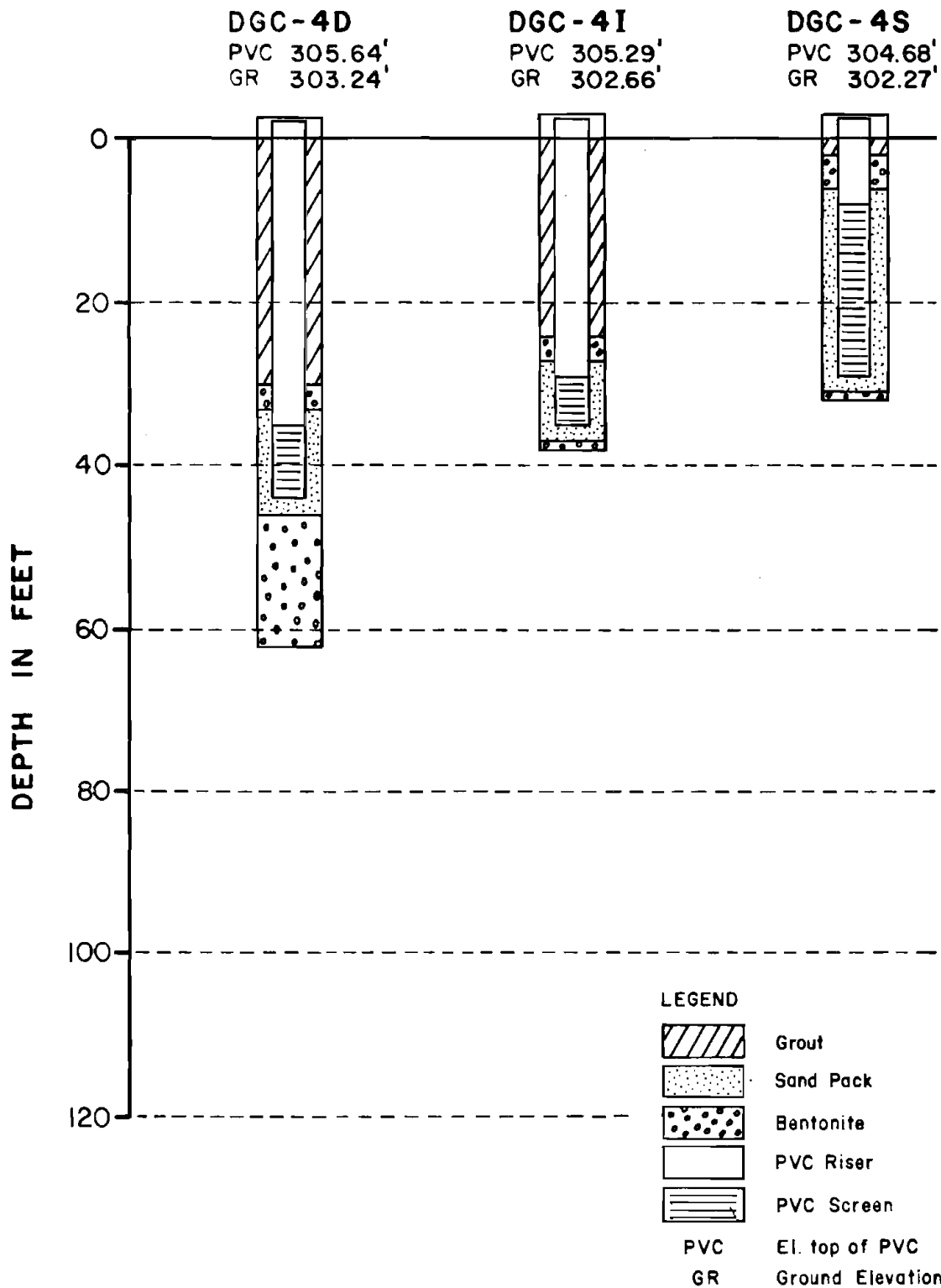

**MONITORING WELL CONSTRUCTION DETAIL
 REMEDIAL INVESTIGATION
 GENERAL ELECTRIC - MOREAU SITE
 Index Number II-CERCLA - 3020I**



Date Drilled 5/21/84 - 5/24/84
 Driller R. Gregory/V. Aimar
 DGC Geologist M. Ianniello/J. Uruskyj
 Site Number DGC-5

Total Depths:
 Shallow Well 48 ft.
 Intermediate Well 72 ft.
 Deep Well 87 ft.

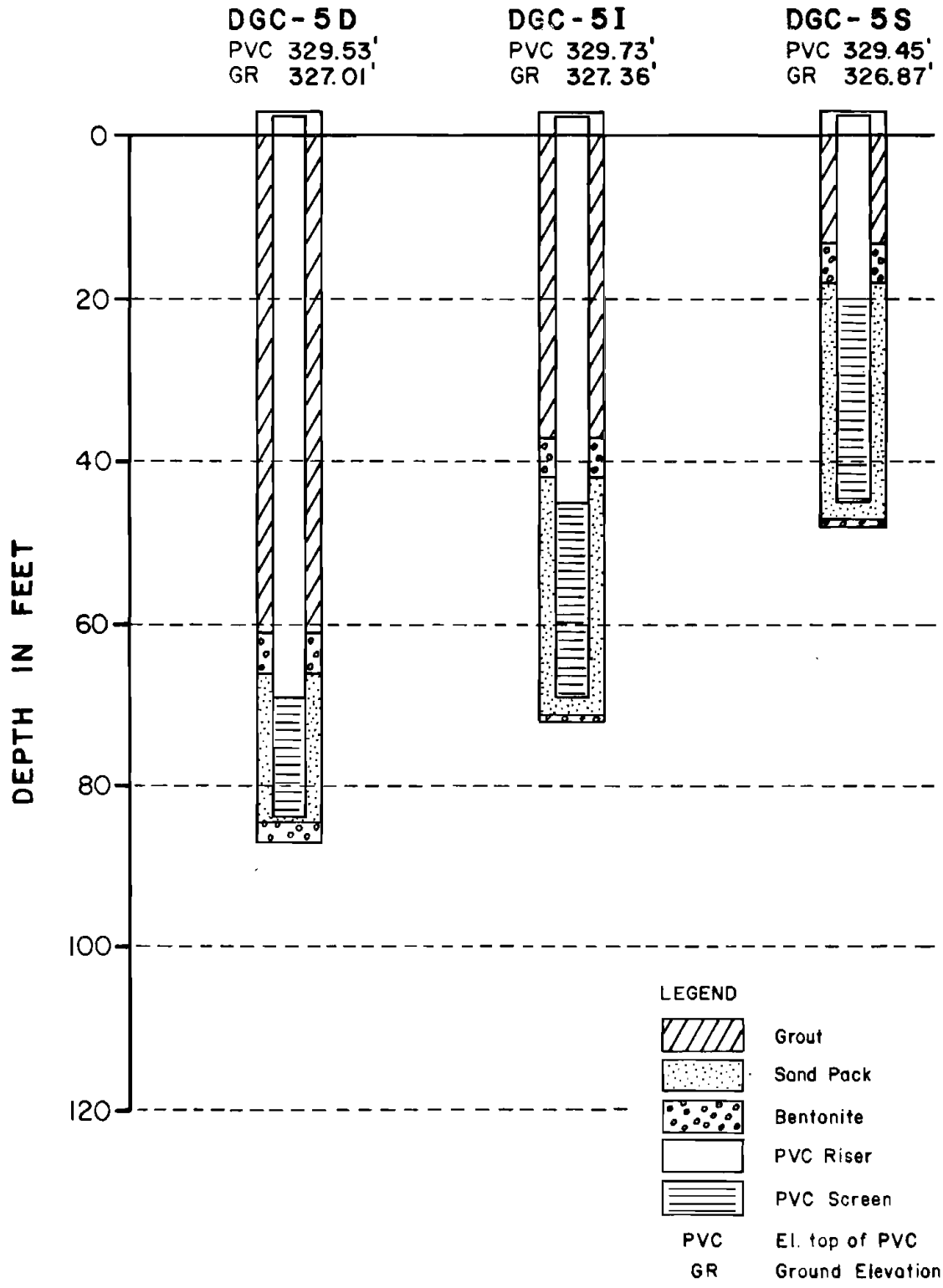

**MONITORING WELL CONSTRUCTION DETAIL
 REMEDIAL INVESTIGATION
 GENERAL ELECTRIC - MOREAU SITE
 Index Number II-CERCLA-30201**



Date Drilled 5/24/84 - 6/4/84
 Driller V. Aimar/R. Gregory
 DGC Geologist J. Uruskyj/M. Ianniello
 Site Number DGC-6

Total Depths:
 Shallow Well 53 ft
 Intermediate Well 78 ft
 Deep Well 104 ft

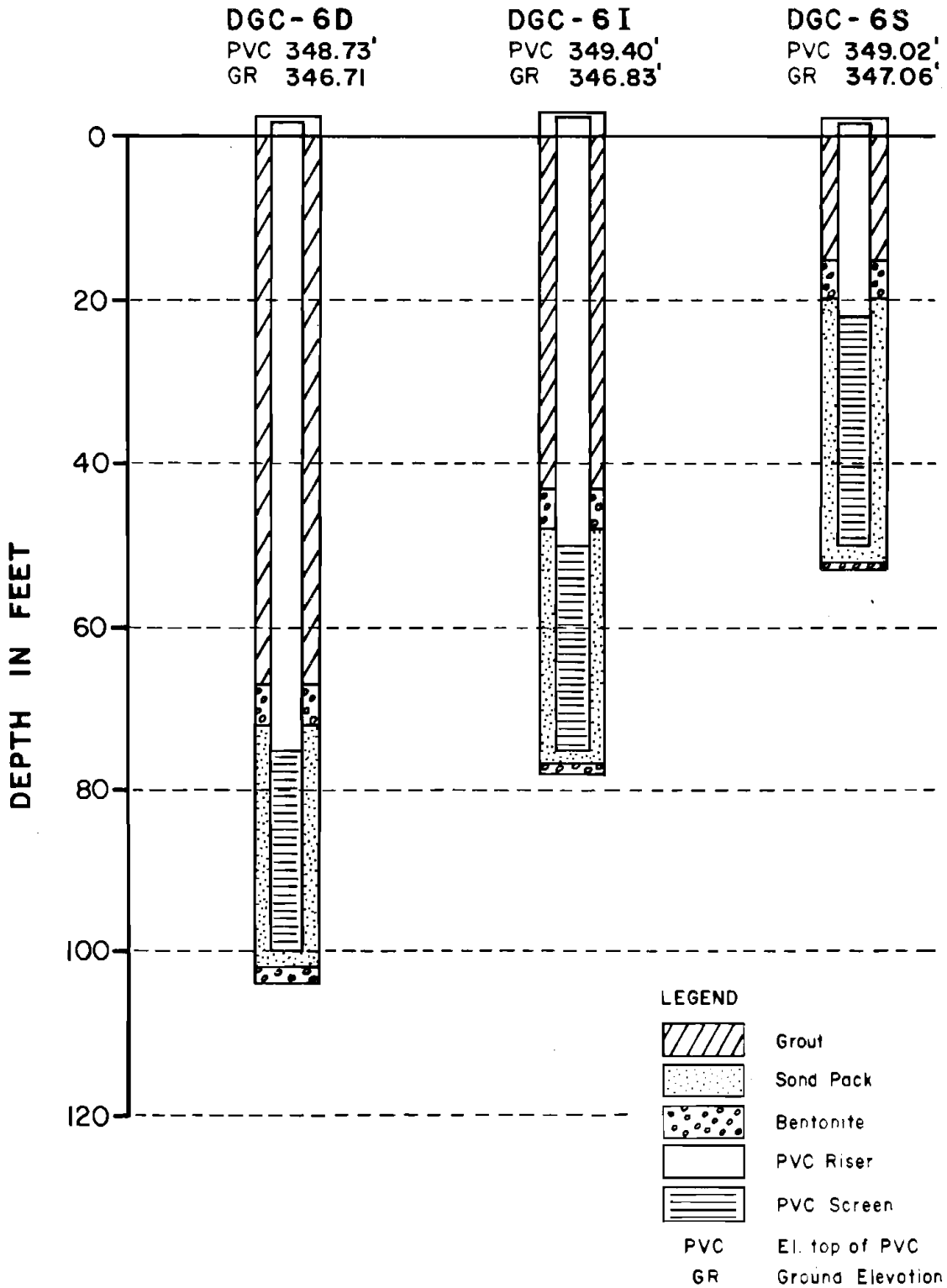

**MONITORING WELL CONSTRUCTION DETAIL
 REMEDIAL INVESTIGATION
 GENERAL ELECTRIC - MOREAU SITE
 Index Number II-CERCLA-3020I**



Date Drilled 5/24/84 - 6/1/84
 Driller V. Aimar
 DGC Geologist J. Uruskyj
 Site Number DGC-7

Total Depths:
 Shallow Well 48 ft.
 Intermediate Well 68 ft.
 Deep Well 92 ft.

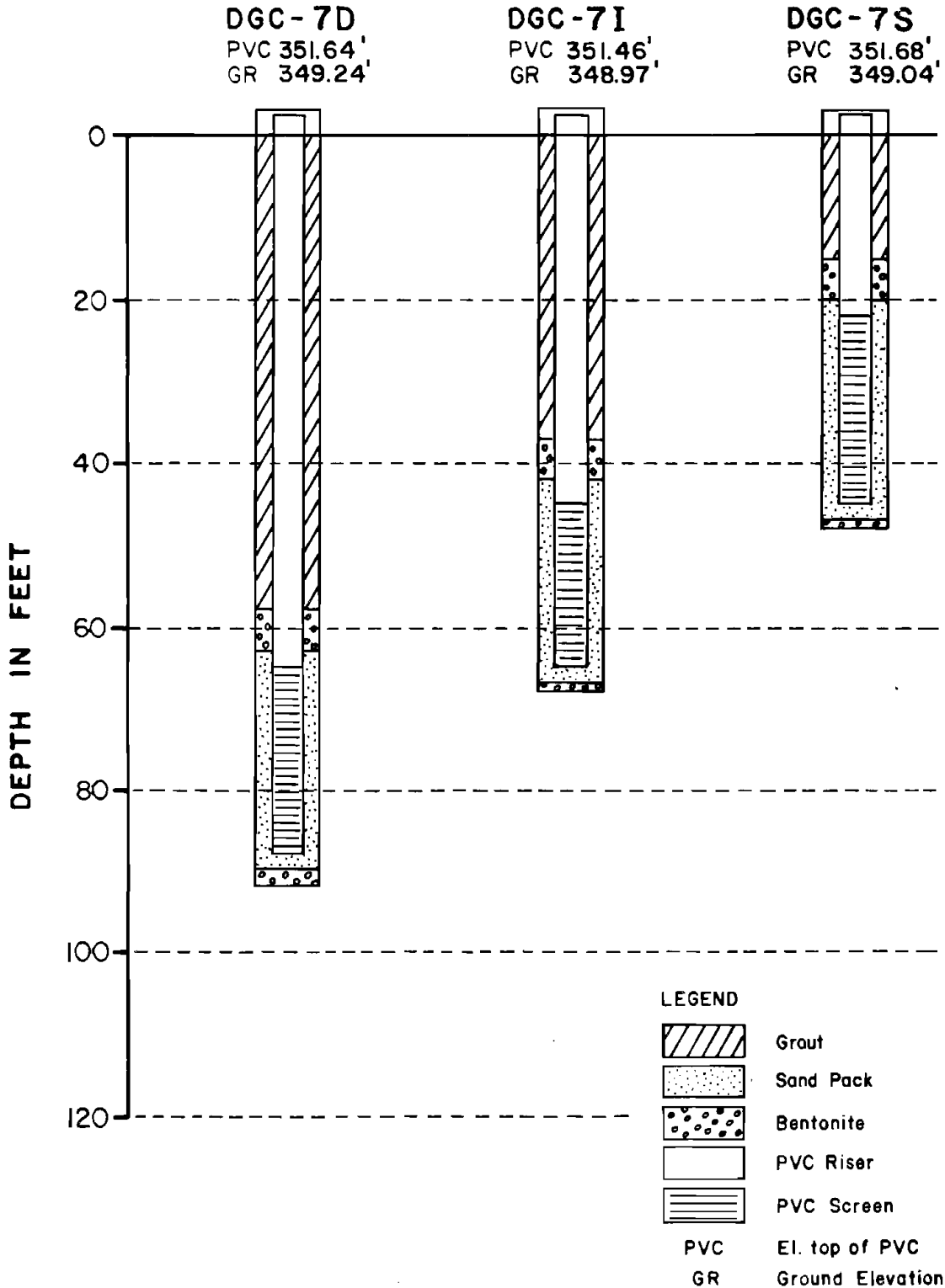

**MONITORING WELL CONSTRUCTION DETAIL
 REMEDIAL INVESTIGATION
 GENERAL ELECTRIC - MOREAU SITE
 Index Number II-CERCLA-30201**



Date Drilled 6/4/84 - 6/7/84
 Driller V. Aimar
 DGC Geologist M. Ianniello/J. Uruskyj
 Site Number DGC-8

Total Depths:
 Shallow Well 48 ft.
 Intermediate Well 78 ft.
 Deep Well 109 ft.

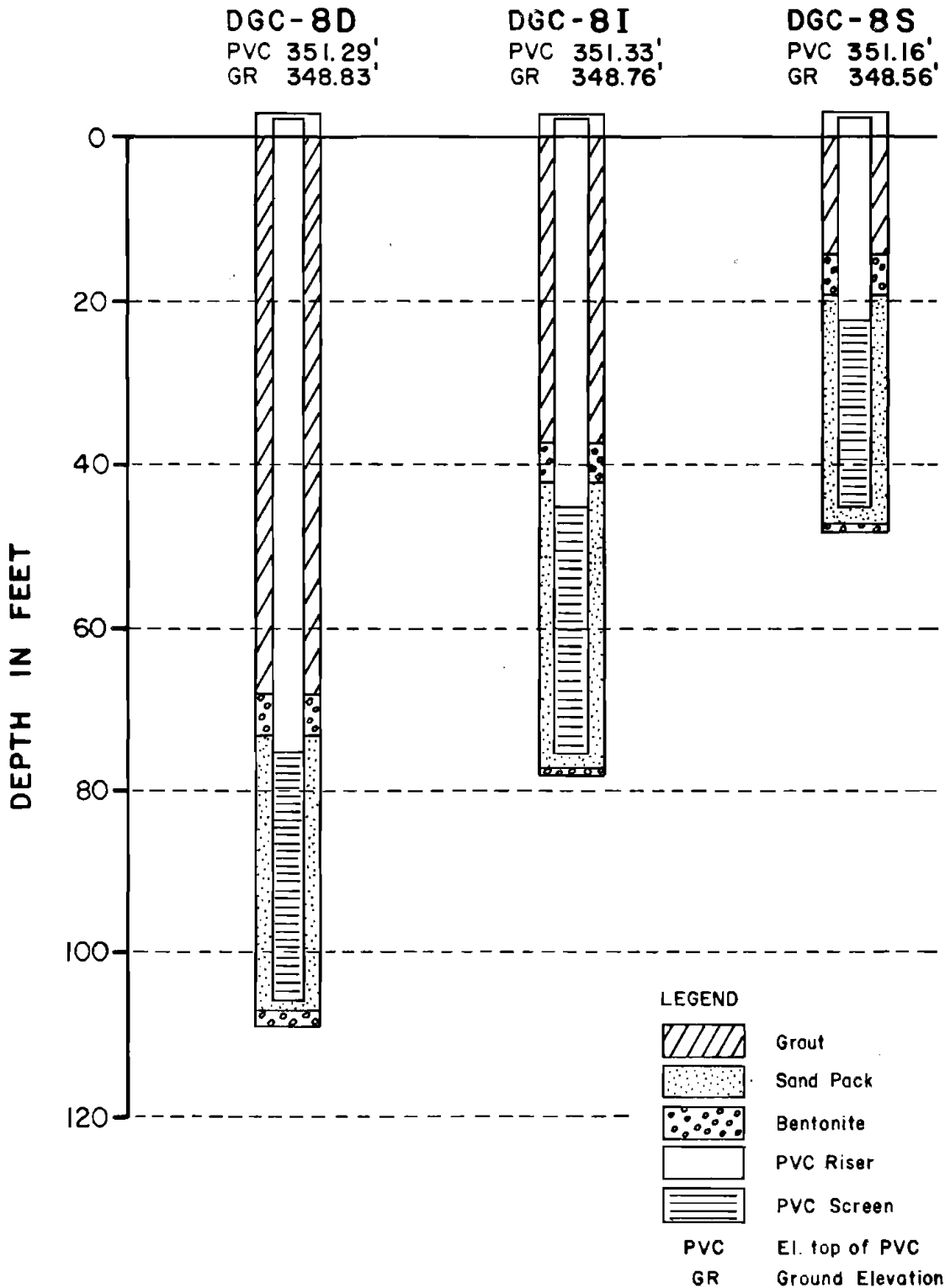

**MONITORING WELL CONSTRUCTION DETAIL
 REMEDIAL INVESTIGATION
 GENERAL ELECTRIC - MOREAU SITE
 Index Number 11-CERCLA-30201**



Date Drilled 6/5/84 - 6/7/84
 Driller R. Gregory
 DGC Geologist M. Ianniello
 Site Number DGC-9

Total Depths:
 Shallow Well 38 ft.
 Intermediate Well 53 ft.
 Deep Well 79 ft.

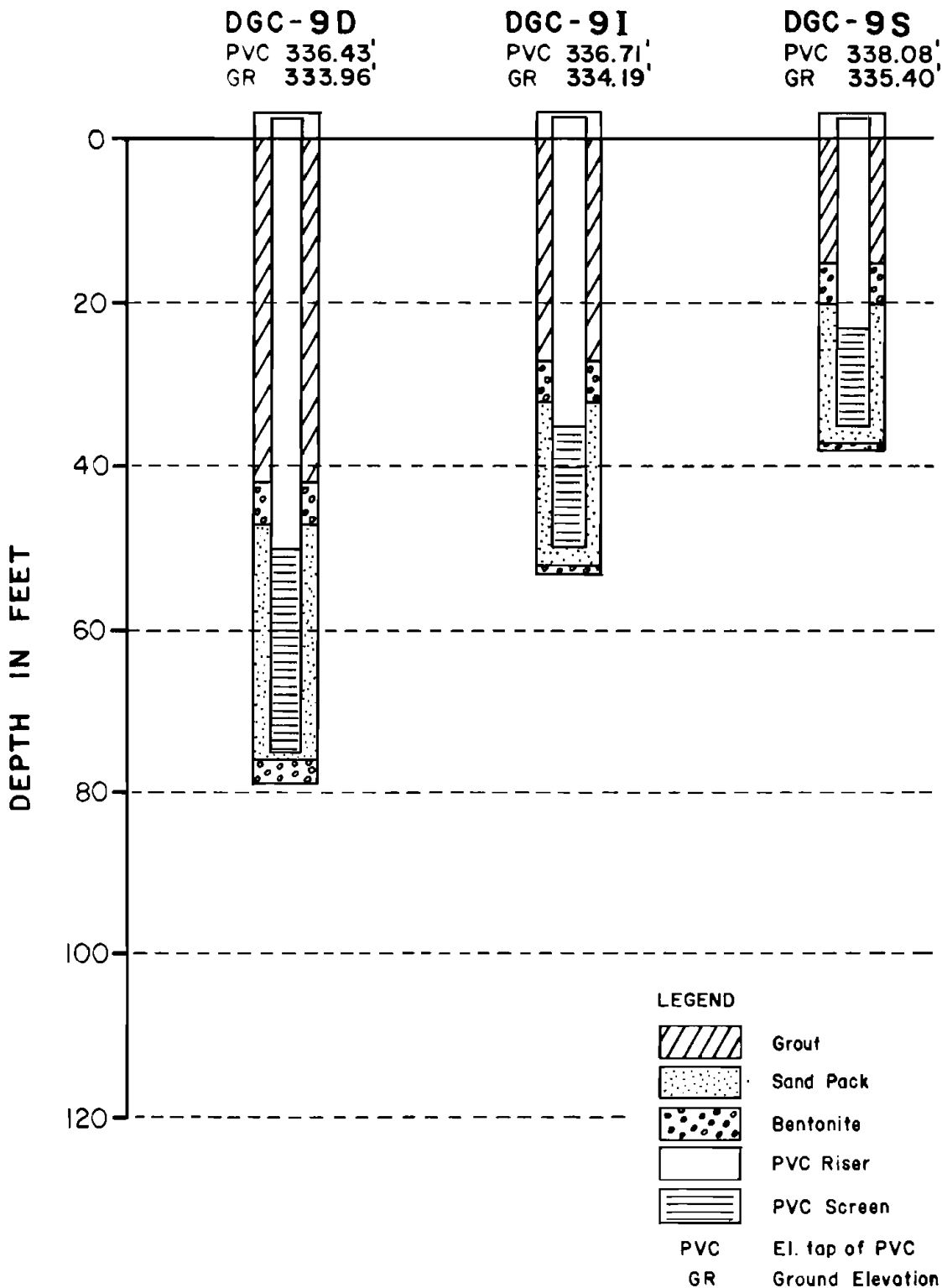

**MONITORING WELL CONSTRUCTION DETAIL
 REMEDIAL INVESTIGATION
 GENERAL ELECTRIC - MOREAU SITE
 Index Number II-CERCLA-3020I**



Date Drilled 6/7/84 - 6/12/84
 Driller R. Gregory
 DGC Geologist M. Ianniello/J. Uruskyj
 Site Number DGC-10

Total Depths:
 Shallow Well 36 ft.
 Intermediate Well 46 ft.
 Deep Well 60 ft.

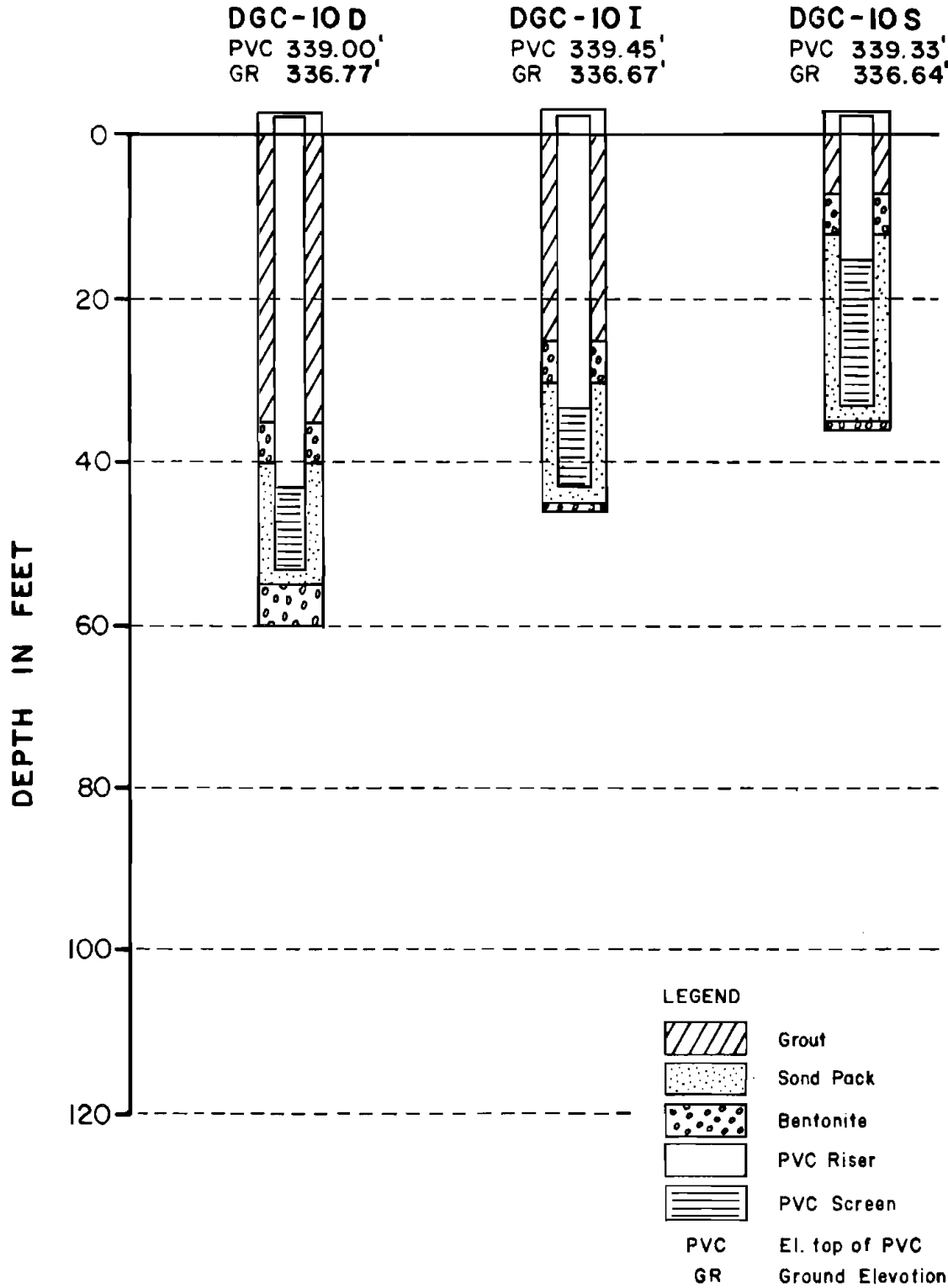

**MONITORING WELL CONSTRUCTION DETAIL
 REMEDIAL INVESTIGATION
 GENERAL ELECTRIC - MOREAU SITE
 Index Number 11-CERCLA-30201**



Date Drilled 6/7/84 - 6/13/84
 Driller V. Aimar/R. Gregory
 DGC Geologist M. Ianniello/J. Uruskyj
 Site Number DGC-11

Total Depths:
 Shallow Well 48 ft
 Intermediate Well 83 ft
 Deep Well 96 ft

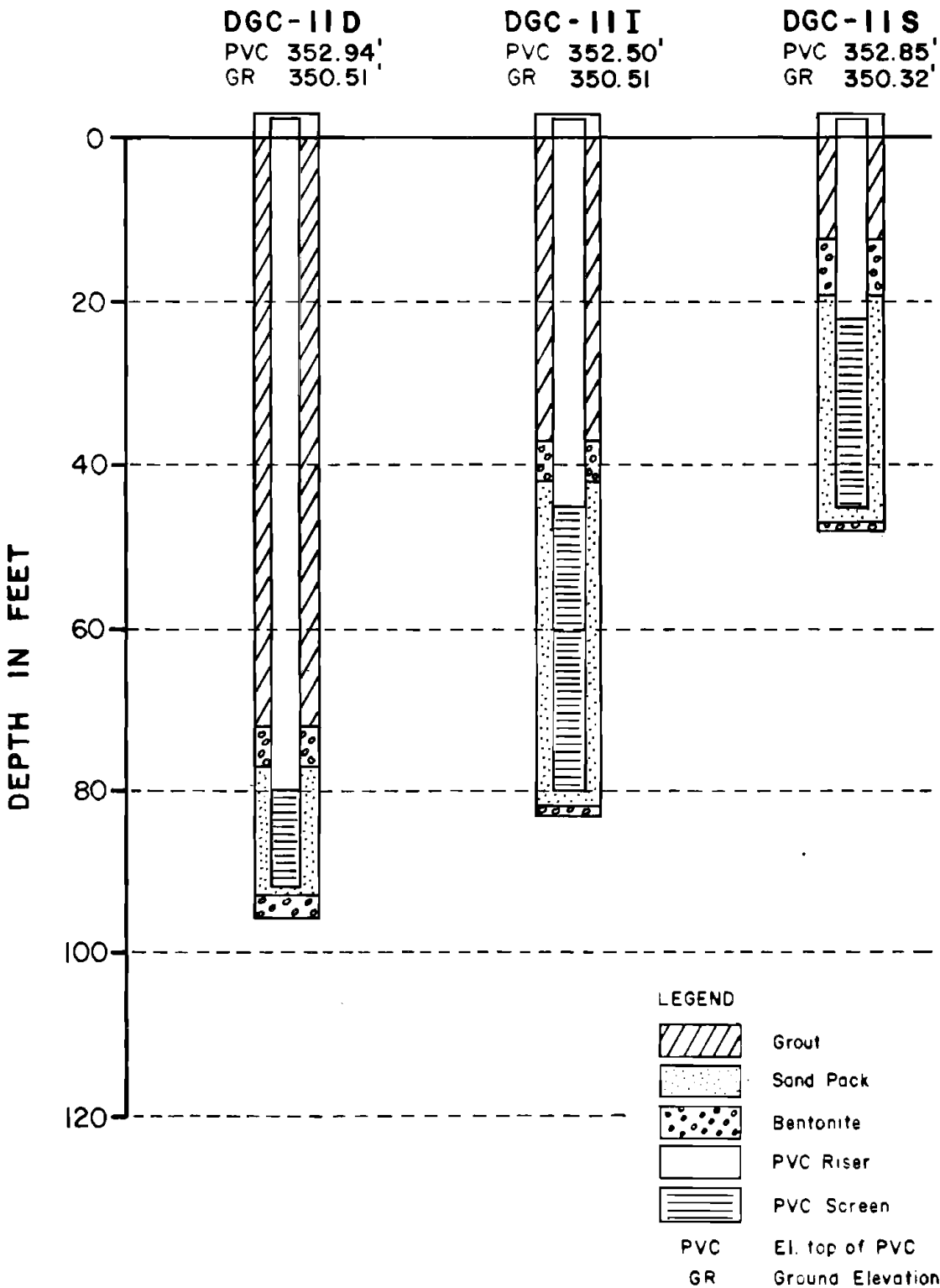

**MONITORING WELL CONSTRUCTION DETAIL
 REMEDIAL INVESTIGATION
 GENERAL ELECTRIC - MOREAU SITE
 Index Number 11-CERCLA-30201**



Date Drilled 6/12/84 - 6/15/84
 Driller V. Aimar/R. Gregory
 DGC Geologist M. Ianniello
 Site Number DGC-12

Total Depths:
 Shallow Well 36 ft.
 Intermediate Well 51 ft.
 Deep Well 67 ft.

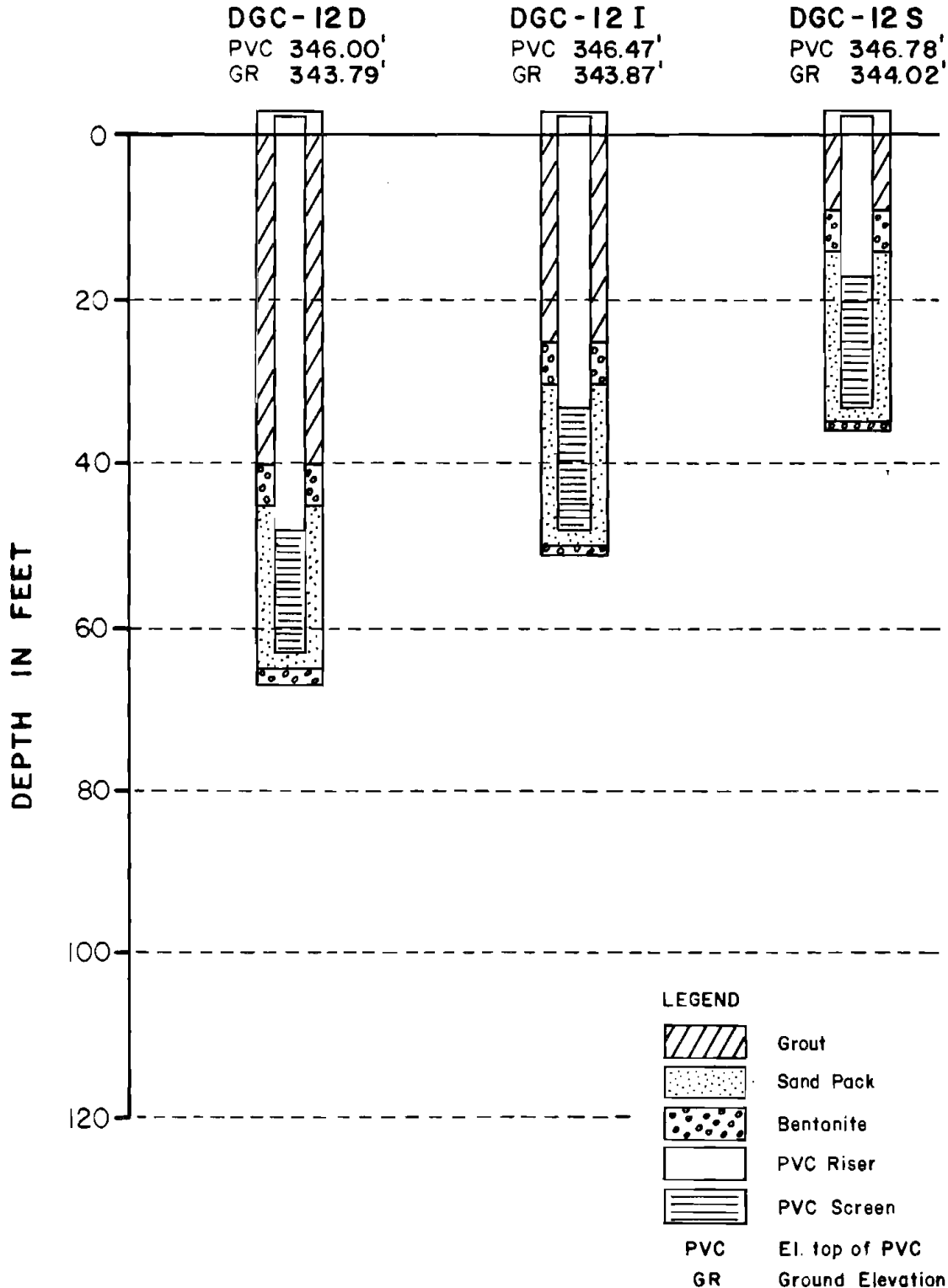

**MONITORING WELL CONSTRUCTION DETAIL
 REMEDIAL INVESTIGATION
 GENERAL ELECTRIC - MOREAU SITE
 Index Number 11-CERCLA-30201**



Date Drilled 6/19/84
 Driller V. Aimar
 DGC Geologist M. Ianniello
 Site Number DGC-13

Total Depths:
 Shallow Well 10 ft.
 Intermediate Well ft.
 Deep Well ft.

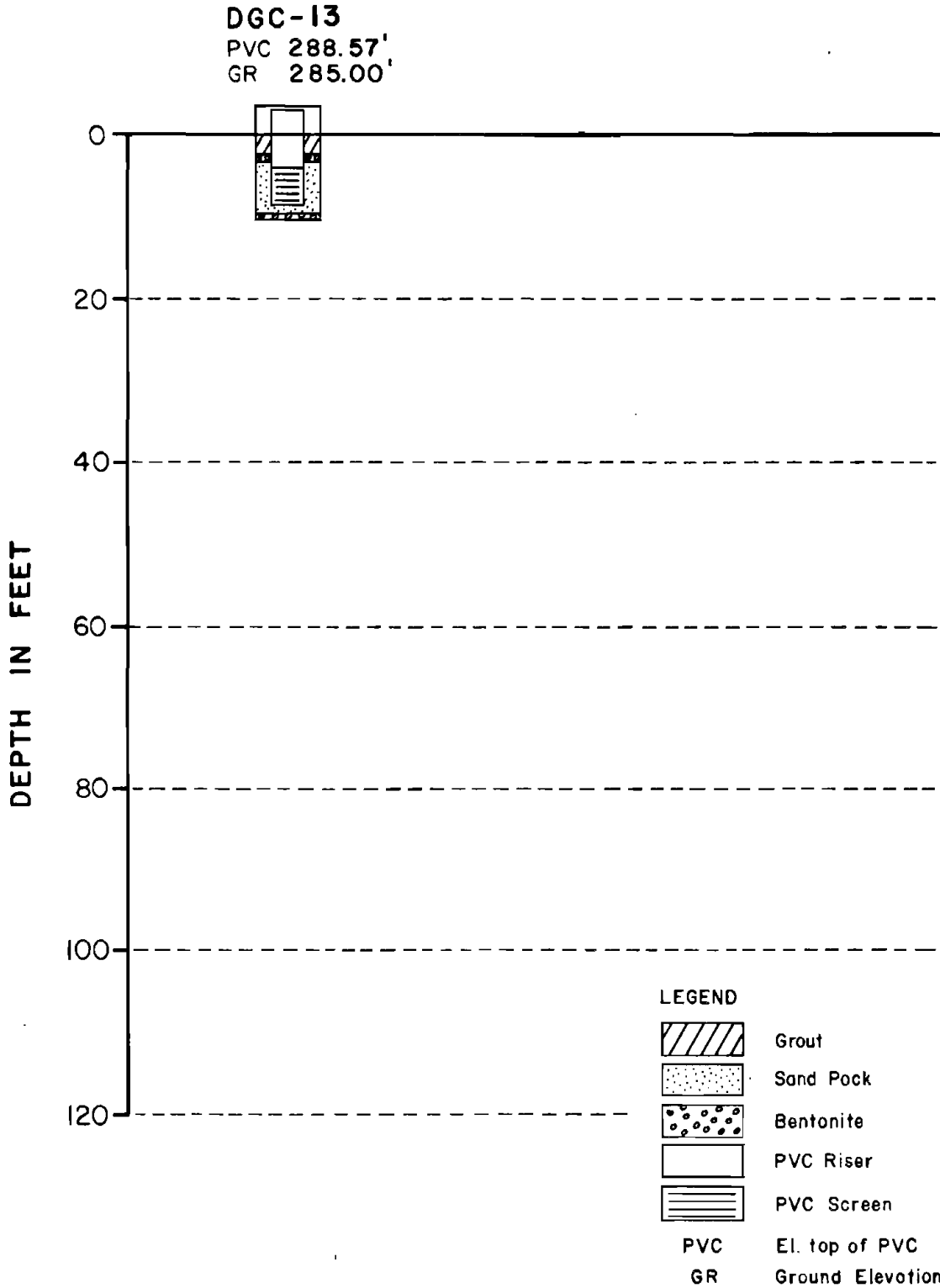

**MONITORING WELL CONSTRUCTION DETAIL
 REMEDIAL INVESTIGATION
 GENERAL ELECTRIC - MOREAU SITE
 Index Number 11-CERCLA - 30201**



Date Drilled 8/1/84
 Driller V. Aimar
 DGC Geologist M. Ianniello
 Site Number DGC-14

Total Depths:
 Shallow Well 51 ft
 Intermediate Well 76 ft
 Deep Well 104.5 ft

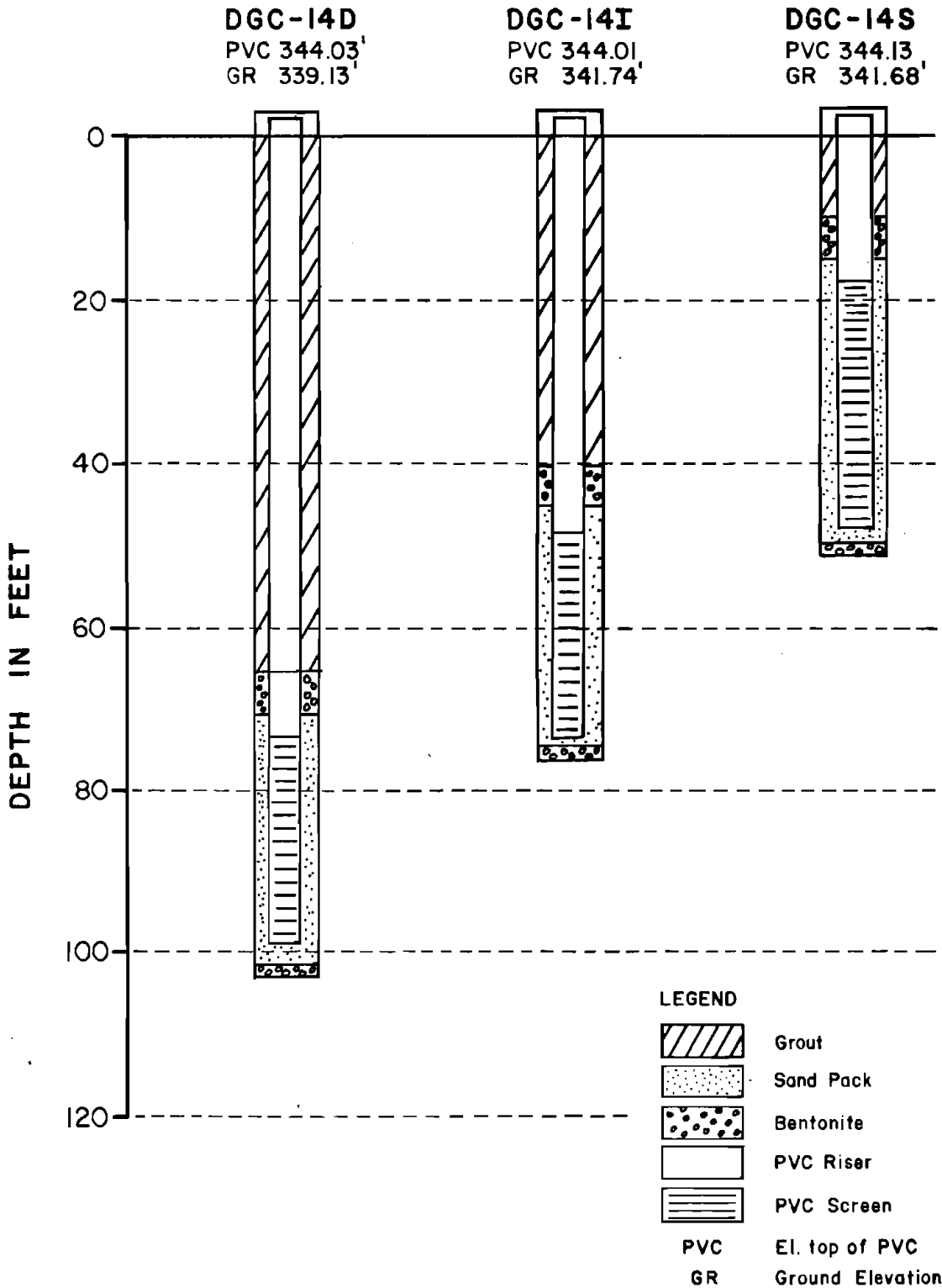

**MONITORING WELL CONSTRUCTION DETAIL
REMEDIAL INVESTIGATION
GENERAL ELECTRIC - MOREAU SITE
Index Number II-CERCLA-30201**



Date Drilled 8/6/84 - 8/10/84
 Driller V. Aimar
 DGC Geologist M. Ianniello, R. Sutch
 Site Number DGC-15

Total Depths:
 Shallow Well 46 ft.
 Intermediate Well 76 ft.
 Deep Well 116 ft.

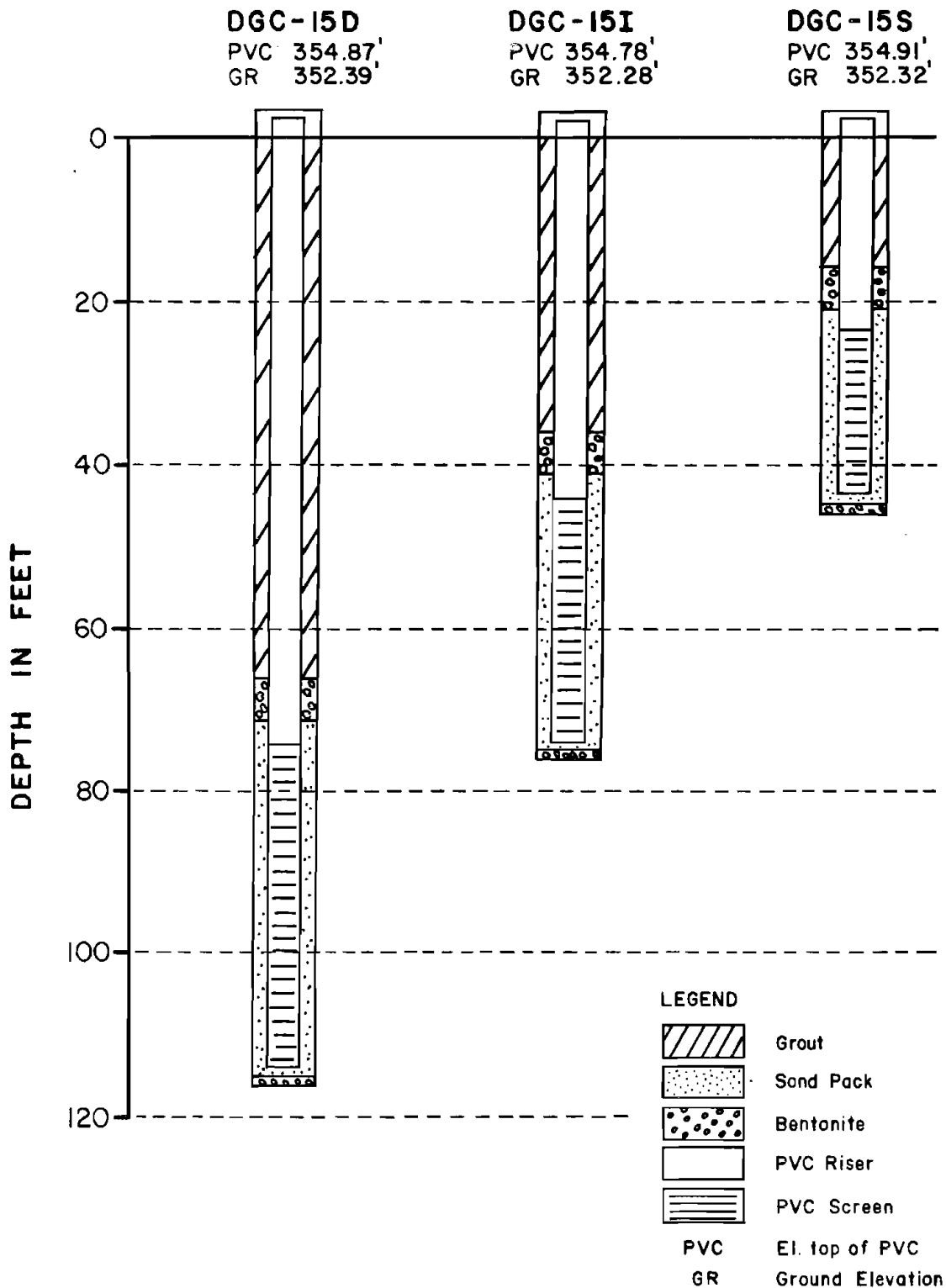

**MONITORING WELL CONSTRUCTION DETAIL
 REMEDIAL INVESTIGATION
 GENERAL ELECTRIC - MOREAU SITE
 Index Number 11-CERCLA - 30201**



Date Drilled 8/13/84
 Driller V. Aimar
 DGC Geologist M. Ianniello, R. Sutch
 Site Number DGC-16

Total Depths:
 Shallow Well 28 ft.
 Intermediate Well -- ft.
 Deep Well 42 ft.

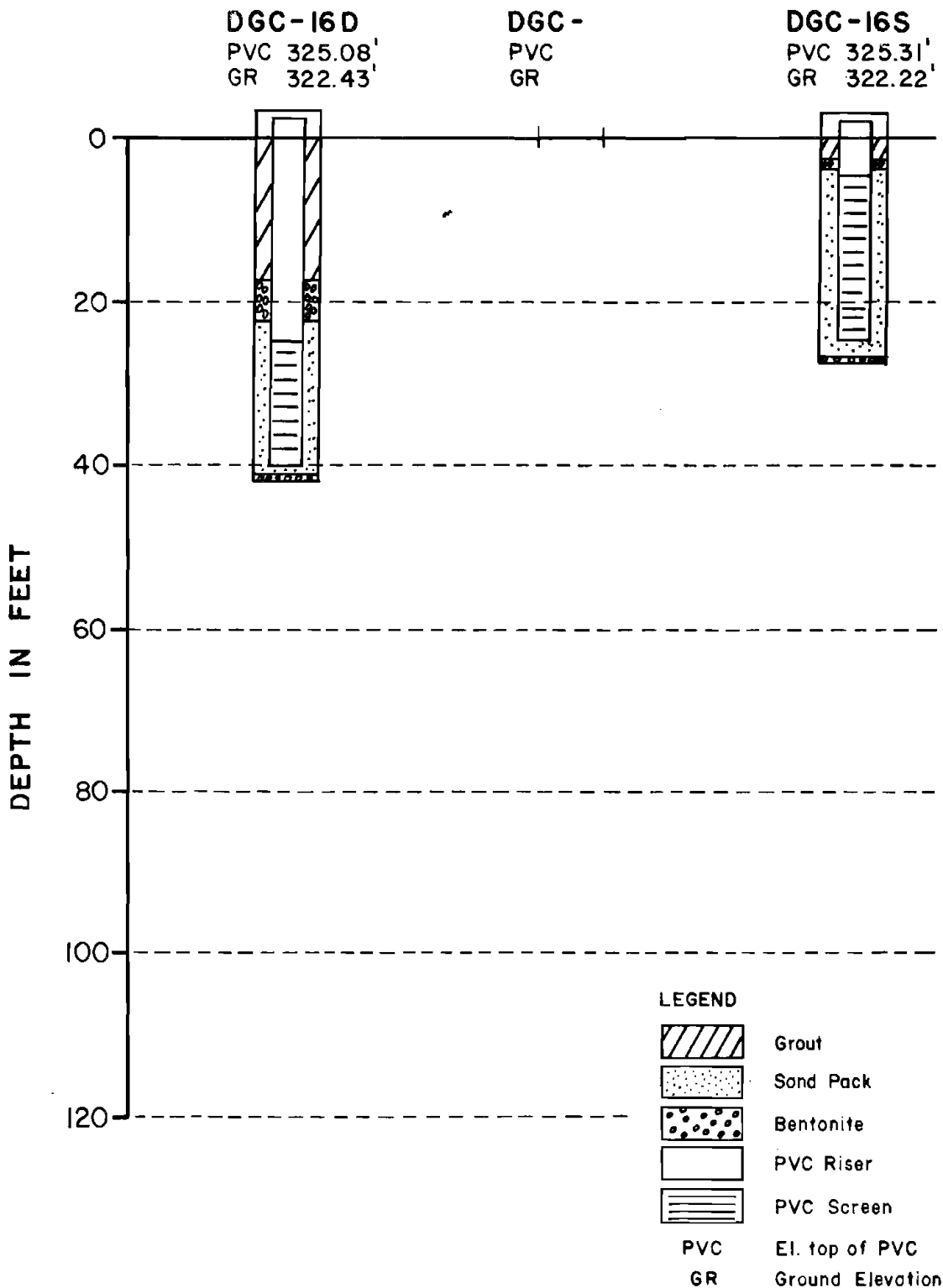

MONITORING WELL CONSTRUCTION DETAIL
 REMEDIAL INVESTIGATION
 GENERAL ELECTRIC - MOREAU SITE
 Index Number II-CERCLA - 30201



Date Drilled 8/14/84
 Driller V. Aimar
 DGC Geologist M. Ianniello, R. Sutch
 Site Number DGC-17

Total Depths:
 Shallow Well _____ ft
 Intermediate Well _____ ft
 Deep Well 55 ft

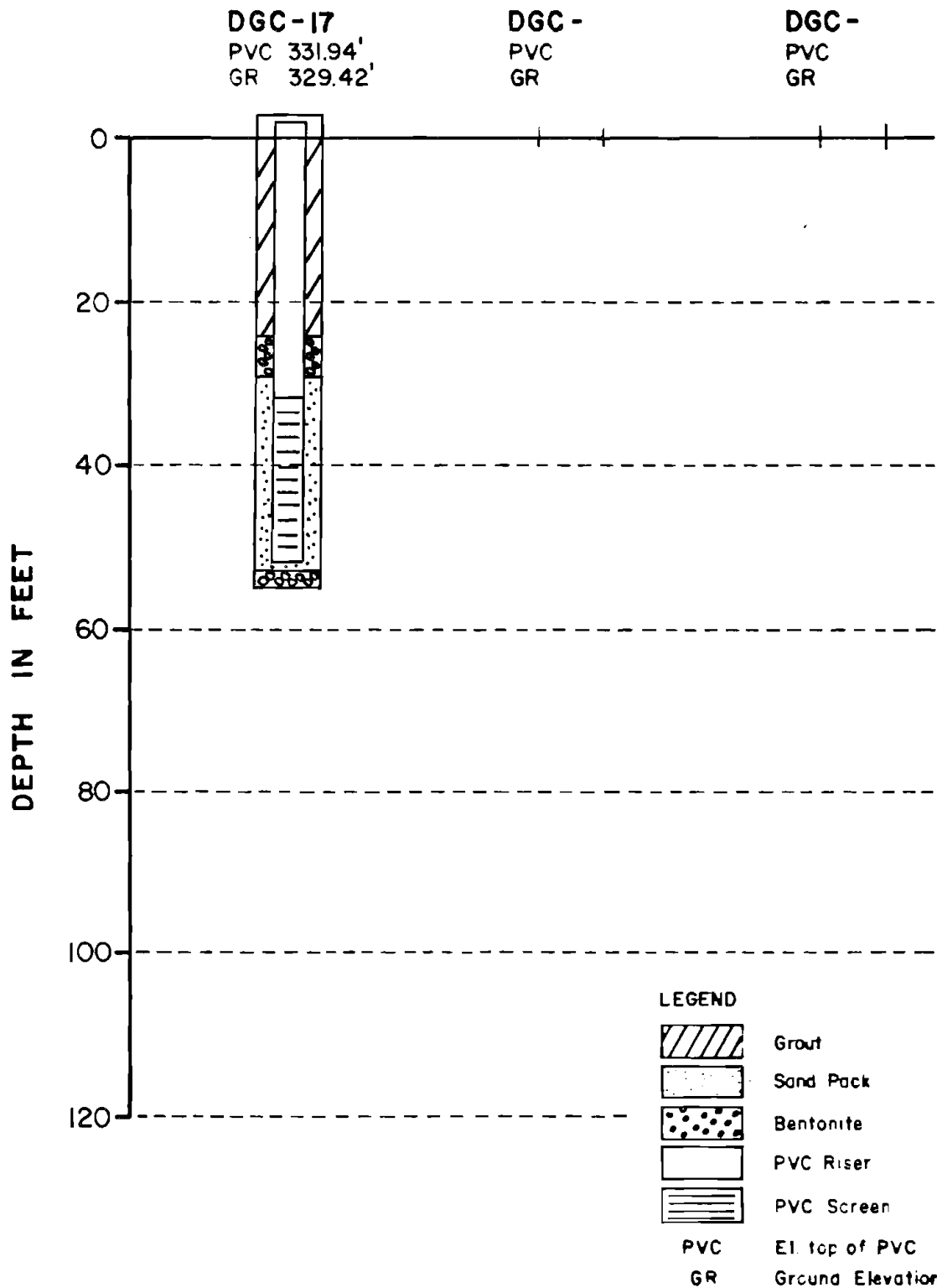

**MONITORING WELL CONSTRUCTION DETAIL
 REMEDIAL INVESTIGATION
 GENERAL ELECTRIC - MOREAU SITE
 Index Number 11-CERCLA-30201**



Date Drilled 8/15/84 - 8/20/84
 Driller V. Aimar
 DGC Geologist M. Ianniello, R. Sutch
 Site Number DGC-18

Total Depths:
 Shallow Well 40 ft
 Intermediate Well 60 ft
 Deep Well 79 ft

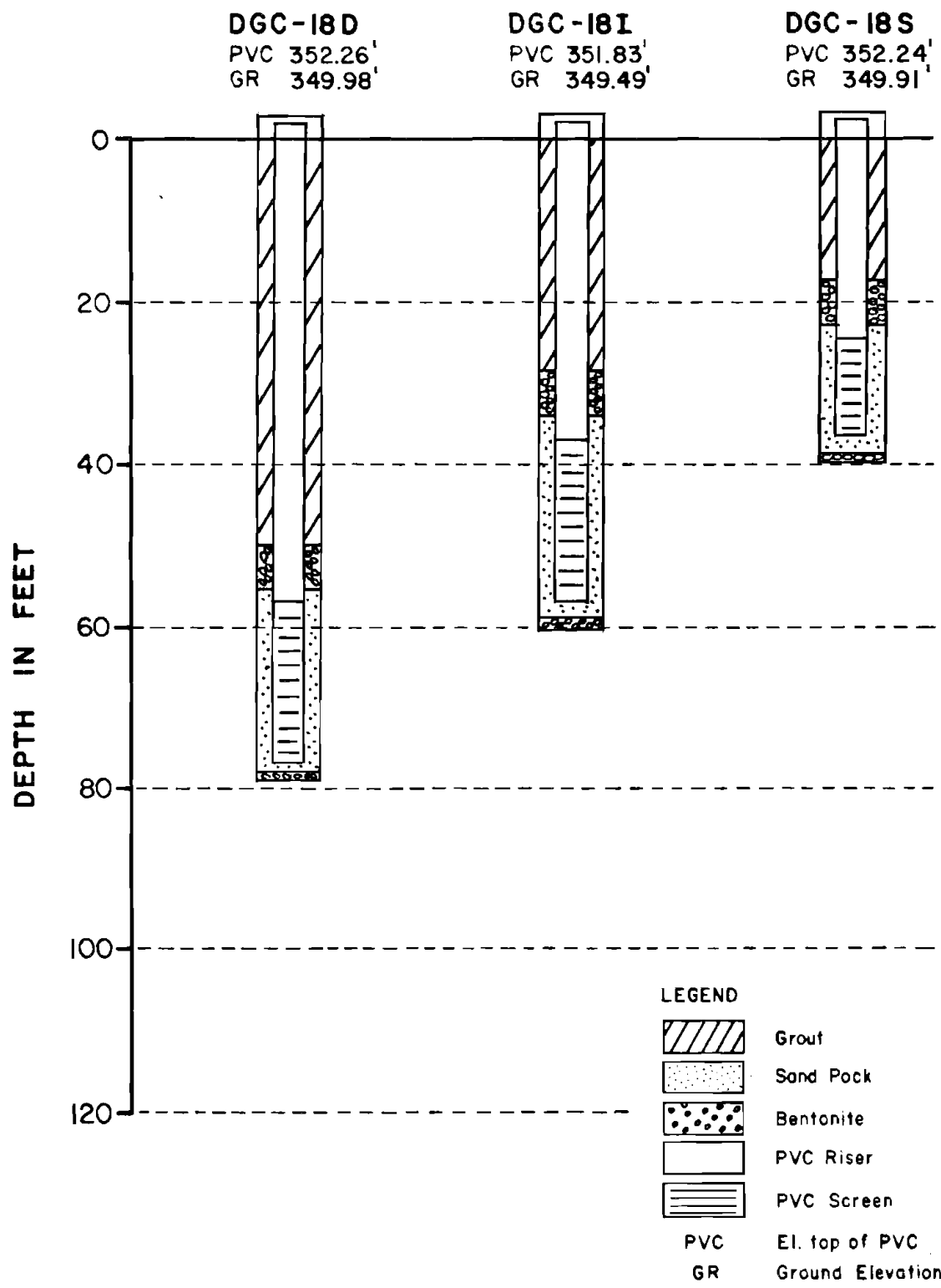

**MONITORING WELL CONSTRUCTION DETAIL
 REMEDIAL INVESTIGATION
 GENERAL ELECTRIC - MOREAU SITE
 Index Number 11-CERCLA-30201**



Date Drilled 8/20/84
 Driller V. Aimar
 DGC Geologist M. Ianniello, R. Sutch
 Site Number DGC-19S

Total Depths:
 Shallow Well 43 ft.
 Intermediate Well ft.
 Deep Well ft.

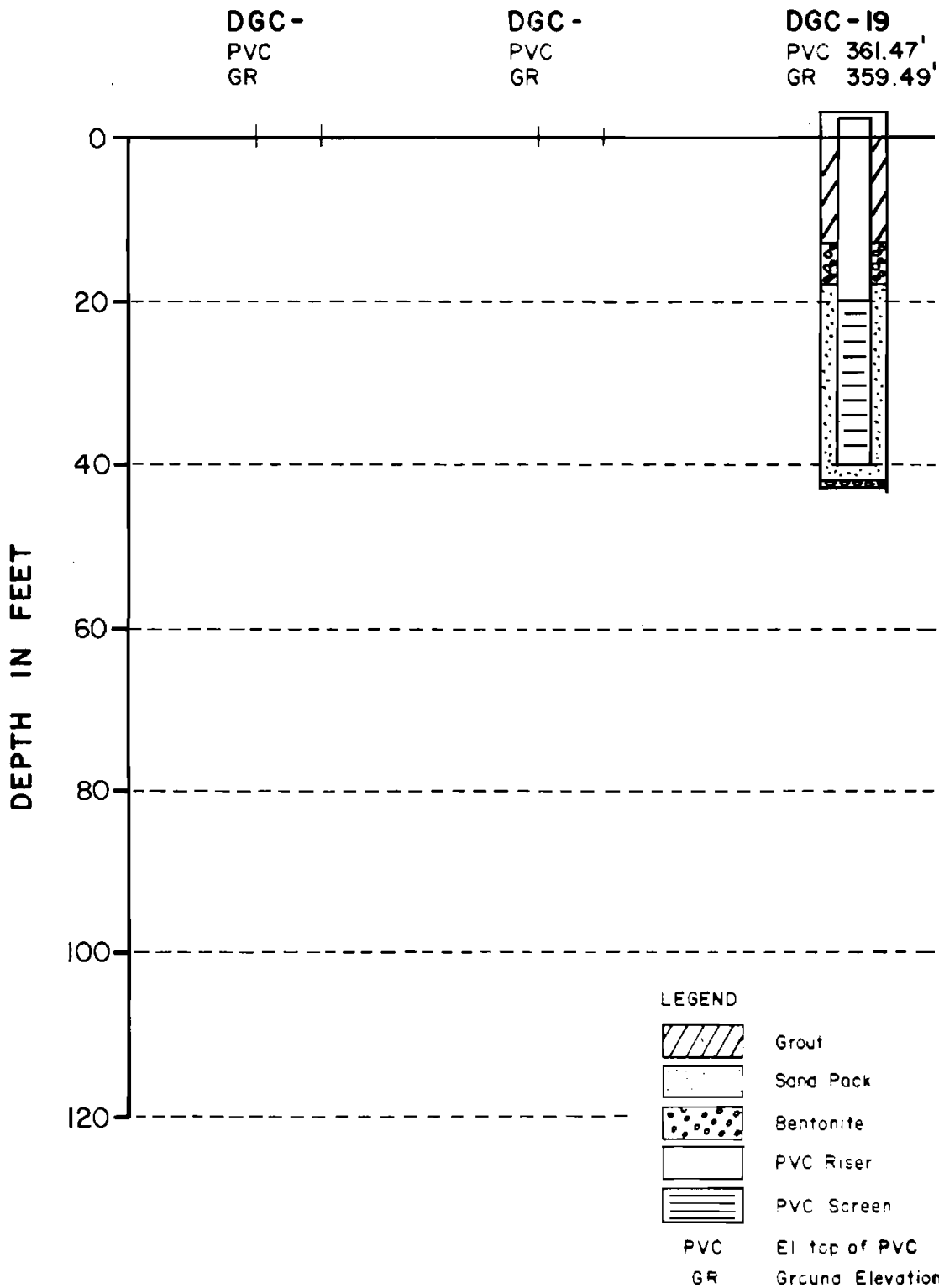

MONITORING WELL CONSTRUCTION DETAIL
REMEDIAL INVESTIGATION
GENERAL ELECTRIC - MOREAU SITE
 Index Number 11-CERCLA-30201



Date Drilled 8/21/84 - 8/23/84
 Driller V. Aimar
 DGC Geologist M. Tanniello
 Site Number DGC-20

Total Depths:
 Shallow Well 58 ft
 Intermediate Well 78 ft
 Deep Well 108 ft

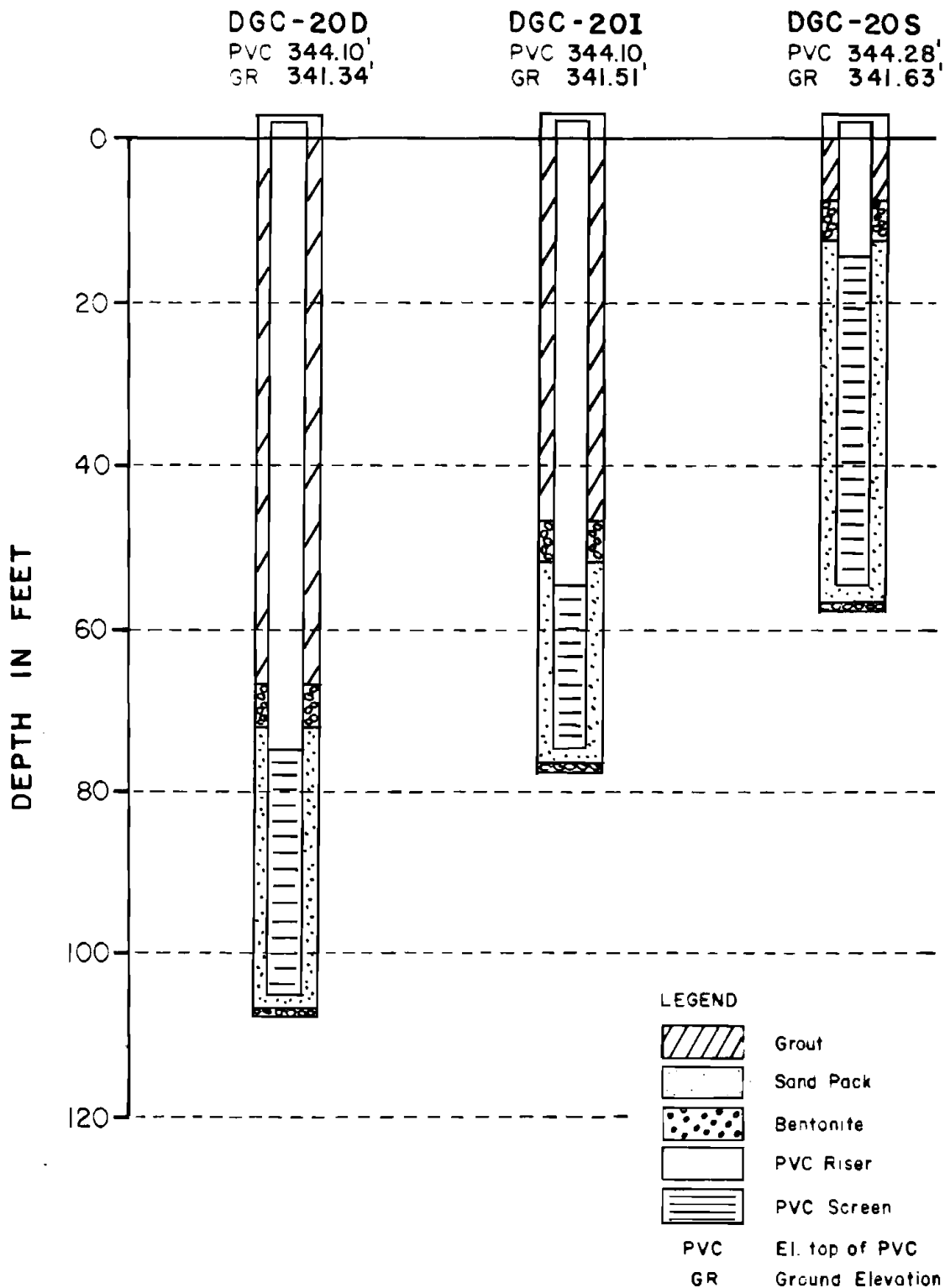

**MONITORING WELL CONSTRUCTION DETAIL
 REMEDIAL INVESTIGATION
 GENERAL ELECTRIC - MOREAU SITE
 Index Number 11-CERCLA-30201**



Date Drilled 8/24/84 - 8/28/84
 Driller V. Aimar
 DGC Geologist M. Ianniello
 Site Number DGC-21

Total Depths:
 Shallow Well 38 ft
 Intermediate Well 73 ft
 Deep Well 105 ft

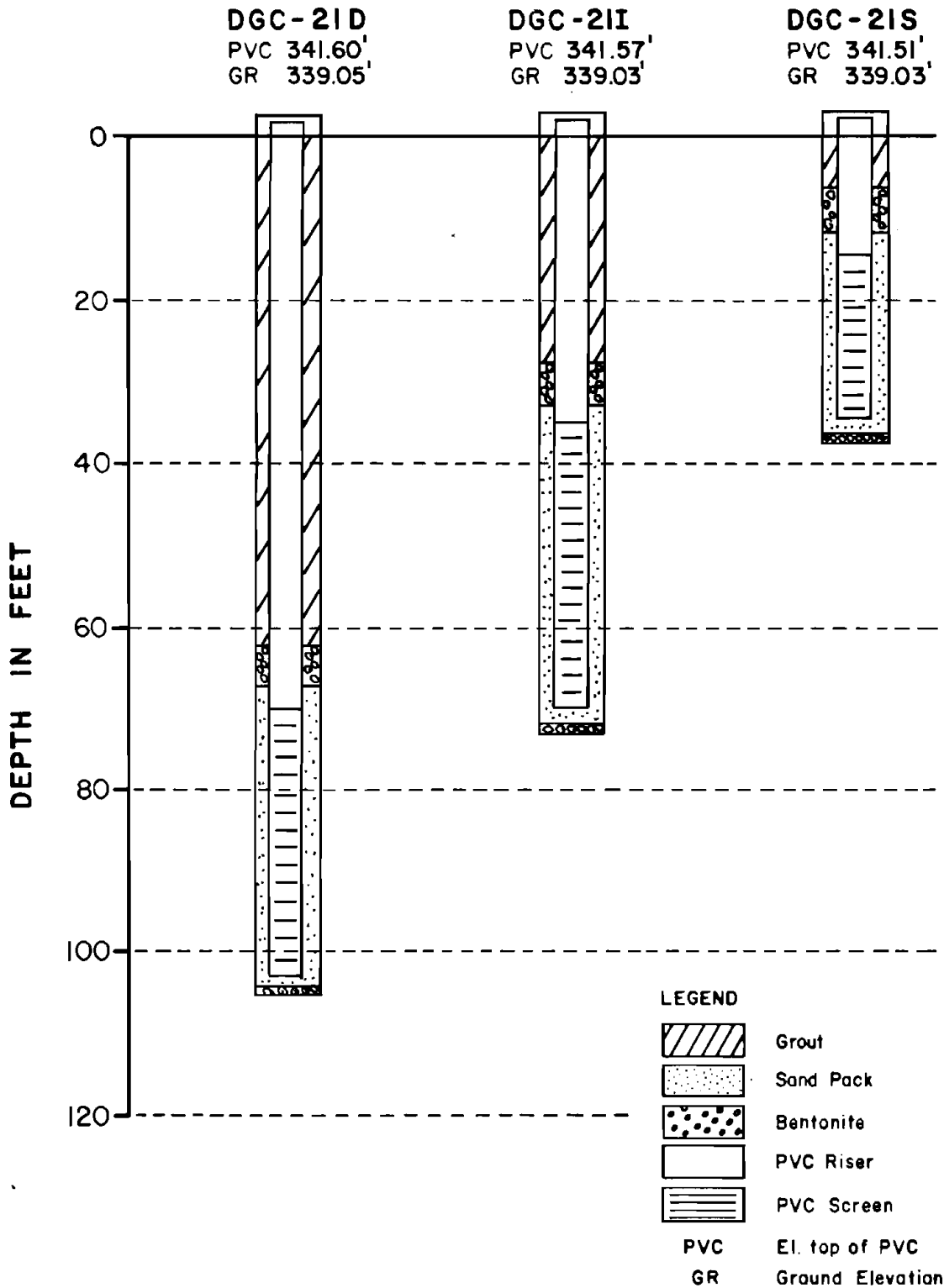

**MONITORING WELL CONSTRUCTION DETAIL
 REMEDIAL INVESTIGATION
 GENERAL ELECTRIC - MOREAU SITE
 Index Number 11-CERCLA - 30201**



Date Drilled 8/29/84 - 8/30/84
 Driller V. Aimar
 DGC Geologist M. Ianniello
 Site Number DGC-22

Total Depths:
 Shallow Well 37 ft
 Intermediate Well 57 ft
 Deep Well 77 ft

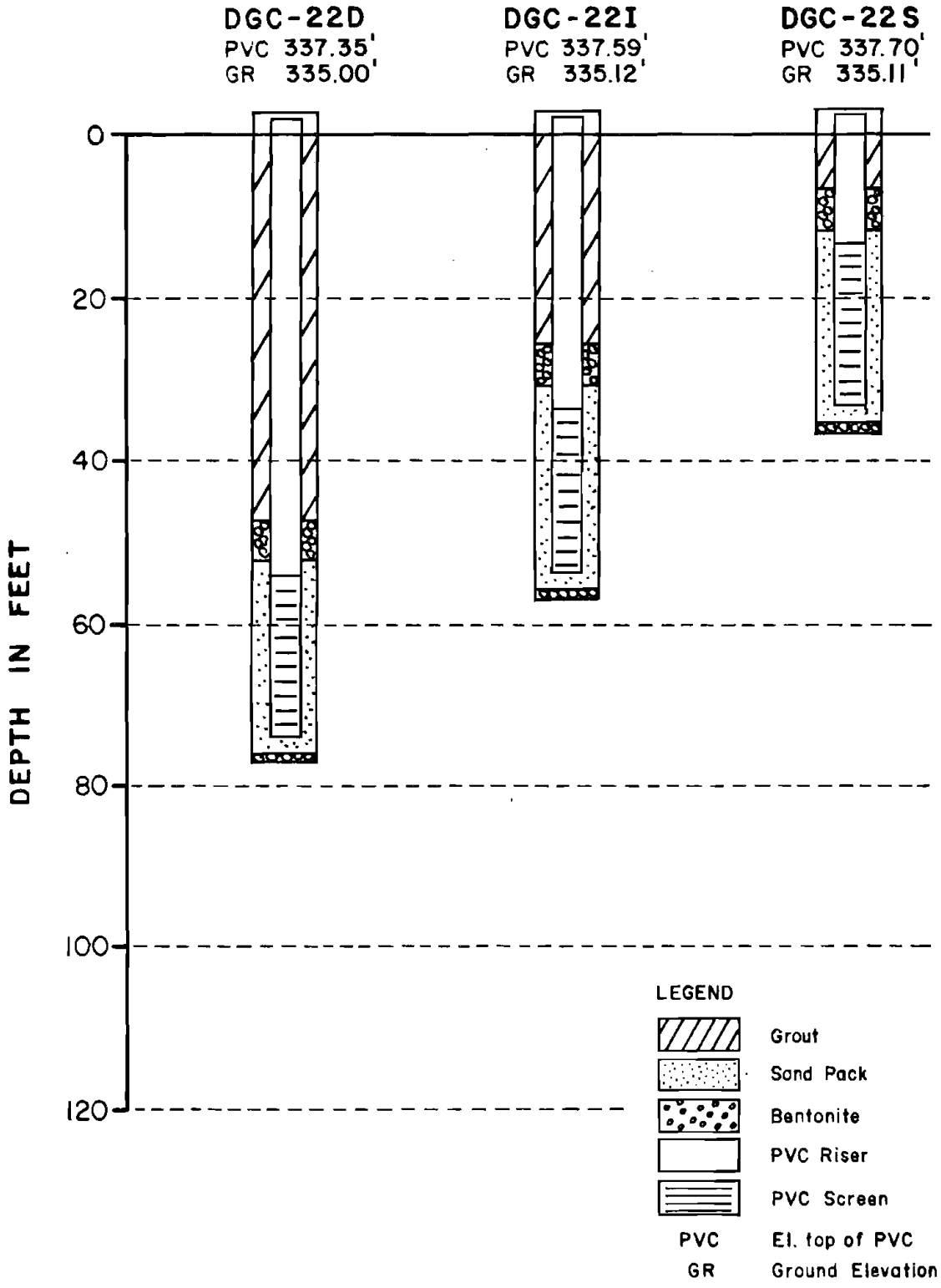

PHOTOIONIZATION RESULTS
383-5-2973

GE Nott St. Remedial Investigation

HNU Systems Model PI-101 Photoionization Analyzer

Dates 5/2/84 - 5/18/84

Well Cluster 1

<u>Boring</u>	<u>Sample Number</u>	<u>Sampling Depth</u>	<u>Time In</u>	<u>Time Out</u>	<u>Background Reading (ppm)</u>	<u>HNU Reading (ppm)</u>	<u>Draeger Tube Reading (ppm)</u>
DGC-1	S-1	0.0- 2.0'	9:13 A	9:43 A	.4	.6	-
	S-2	2.0- 4.0'	9:17 A	9:47 A	.4	.4	-
	S-3	4.0- 6.0'	1:31 P	2:02 P	.7	3.1	-
	S-4	6.0- 8.0'	1:35 P	2:05 P	.4	.6	-
	S-5	8.0-10.0'	1:45 P	2:16 P	.4	.5	-
	S-6	10.0-12.0'	1:55 P	2:25 P	.3	.6	-
	S-7	12.0-14.0'	2:05 P	2:36 P	.4	.7	-
	S-8	14.0-16.0'	2:16 P	2:49 P	.4	1.1	-
	S-9	16.0-18.0'	2:23 P	2:54 P	.4	.5	-
	S-10	18.0-20.0'	2:34 P	3:05 P	.4	.5	-
	S-11	20.0-22.0'	2:49 P	3:19 P	.4	.7	-
	S-12	22.0-24.0'	2:54 P	3:27 P	.5	1.6	-
	S-13	24.0-26.0'	3:59 P	4:29 P	.3	.6	-
	S-14	26.0-28.0'	4:04 P	4:34 P	.3	.6	-
	S-15	28.0-30.0'	4:20 P	4:50 P	.4	.5	-
	S-16	30.0-32.0'	4:29 P	4:59 P	.3	.5	-
	S-17	32.0-34.0'	4:39 P	5:08 P	.3	.9	-
	S-18	34.0-36.0'	9:32 A	10:03 A	.3	.6	-
	S-19	36.0-38.0'	9:38 A	10:07 A	.4	.5	-
	S-20	38.0-40.0'	9:53 A	10:24 A	.5	.8	-
	S-21	40.0-42.0'	10:07 A	10:39 A	.3	.5	-
	S-22	42.0-44.0'	10:23 A	10:54 A	.4	1.5	-
	S-23	44.0-46.0'	11:03 A	11:33 A	.4	.7	-
	S-24	46.0-48.0'	11:11 A	11:43 A	.5	1.7	-
	S-25	48.0-50.0'	1:30 P	2:02 P	.7	2.8	BMDL
	S-26	50.0-52.0'	1:56 P	2:26 P	.3	.3	-
	S-27	52.0-54.0'	2:06 P	2:36 P	.3	.3	-
	S-28	54.0-56.0'	3:31 P	4:01 P	.3	.3	-
	S-29	56.0-58.0'	3:44 P	4:15 P	.4	.5	-
	S-30	58.0-60.0'	4:10 P	4:40 P	.3	.3	-

<u>Boring</u>	<u>Sample Number</u>	<u>Sampling Depth</u>	<u>Time In</u>	<u>Time Out</u>	<u>Background Reading (ppm)</u>	<u>HNU Reading (ppm)</u>	<u>Draeger Tube Reading (ppm)</u>
DGC-1	S-31	60.0-62.0'	5:19 P	5:49 P	.6	.6	-
	S-32	62.0-64.0'	5:25 P	5:55 P	.5	.6	-
	S-33	64.0-66.0'	10:00 A	10:30 A	.5	.5	-
	S-34	66.0-68.0'	10:00 A	10:30 A	.5	.6	-
	S-35	68.0-70.0'	1:36 P	2:07 P	.3	1.3	-
	S-36	70.0-72.0'	1:36 P	2:08 P	.3	.3	-
	S-37	72.0-74.0'	5:12 P	5:42 P	.3	.3	-
DGC-1I	S-1		No Recovery				
	S-2	47.0-49.0'	1:37 P	2:07 P	.3	.6	-
DGC-1S	S-1	26.0-28.0'	11:25 A	12:05 P	.5	1.0	-
	S-2	28.0-30.0'	11:25 A	12:05 P	.5	1.1	-

PHOTOIONIZATION RESULTS
383-5-2973

GE Nott St. Remedial Investigation

HNU Systems Model PI-101 Photoionization Analyzer

Dates 5/8/84 - 5/17/84

Well Cluster 2

<u>Boring</u>	<u>Sample Number</u>	<u>Sampling Depth</u>	<u>Time In</u>	<u>Time Out</u>	<u>Background Reading (ppm)</u>	<u>HNU Reading (ppm)</u>	<u>Draeger Tube Reading (ppm)</u>
DGC-2	S-1	0.0- 2.0'	10:25 A	10:55 A	.5	1.6	-
	S-2	2.0- 4.0'	10:45 A	11:15 A	.4	1.0	-
	S-3	4.0- 6.0'	10:50 A	11:20 A	.5	1.4	-
	S-4	6.0- 8.0'	8:21 A	8:54 A	.5	3.0	-
	S-5	8.0-10.0'	8:28 A	8:59 A	.6	.9	-
	S-6	10.0-12.0'	8:34 A	9:03 A	.5	1.5	-
	S-7	12.0-14.0'	8:37 A	9:20 A	.5	1.2	-
	S-8	14.0-16.0'	8:46 A	9:21 A	.3	1.1	-
	S-9	16.0-18.0'	8:50 A	9:23 A	.4	1.8	-
	S-10	18.0-20.0'	8:57 A	9:25 A	.3	1.6	-
	S-11	20.0-22.0'	9:10 A	9:42 A	.6	1.9	-
	S-12	22.0-24.0'	9:29 A	10:00 A	.5	1.0	-
	S-13	24.0-26.0'	9:31 A	10:01 A	.5	.8	-
	S-14	26.0-28.0'	9:40 A	10:10 A	.3	.5	-
	S-15	28.0-30.0'	9:50 A	10:20 A	.4	.9	-
	S-16	30.0-32.0'	10:07 A	10:37 A	.5	3.2	BMDL
	S-17	32.0-34.0'	10:10 A	10:40 A	.5	1.2	-
	S-18	34.0-36.0'	10:14 A	10:44 A	.5	2.5	-
	S-19	36.0-38.0'	10:30 A	11:01 A	.3	5.6	BMDL
	S-20	38.0-40.0'	10:40 A	11:10 A	.4	4.3	BMDL
	S-21	40.0-42.0'	10:49 A	11:21 A	.4	2.3	-
	S-22	42.0-44.0'	11:11 A	11:42 A	.3	3.6	-
	S-23	44.0-46.0'	11:20 A	11:50 A	.3	4.9	-
	S-24	46.0-48.0'	11:30 A	12:00 P	.4	2.1	-
	S-25	48.0-50.0'	11:43 A	12:13 P	.4	3.7	-
	S-26	50.0-52.0'	1:35 P	2:05 P	.8	3.4	-
	S-27	52.0-54.0'	1:46 P	2:18 P	.3	4.8	BMDL
	S-28	54.0-56.0'	1:55 P	2:27 P	.3	.8	-
	S-29	56.0-58.0'	2:03 P	2:35 P	.3	2.4	-
	S-30	58.0-60.0'	2:13 P	2:44 P	.3	1.1	-

<u>Boring</u>	<u>Sample Number</u>	<u>Sampling Depth</u>	<u>Time In</u>	<u>Time Out</u>	<u>Background Reading (ppm)</u>	<u>HNU Reading (ppm)</u>	<u>Draeger Tube Reading (ppm)</u>
DGC-2	S-31	60.0-62.0'	2:29 P	2:58 P	.2	.3	-
	S-32	62.0-64.0'	2:41 P	3:25 P	.3	.9	-
	S-33	64.0-66.0'	2:48 P	3:25 P	.3	.6	-
	S-34	66.0-68.0'	3:06 P	3:36 P	.3	.3	-
	S-35	68.0-70.0'	3:11 P	3:41 P	.3	.4	-
	S-36	70.0-72.0'	4:40 P	5:10 P	.4	.5	-
	S-37	72.0-74.0'	4:40 P	5:10 P	.4	.4	-
	S-38	74.0-76.0'	4:50 P	5:20 P	.3	.3	-
	S-39	76.0-78.0'	5:04 P	5:34 P	.3	.3	-
DGC-2I	S-1	41.0-43.0'	No Recovery				
	S-2	43.0-45.0'	4:01 P	4:40 P	.4	1.1	-
DGC-2S	S-1	24.0-26.0'	4:02 P	4:41 P	.3	.5	-

PHOTOIONIZATION RESULTS
383-5-2973

GE Nott St. Remedial Investigation

HNU Systems Model PI-101 Photoionization Analyzer

Dates 5/10/84 - 5/16/84

Well Cluster 3

<u>Boring</u>	<u>Sample Number</u>	<u>Sampling Depth</u>	<u>Time In</u>	<u>Time Out</u>	<u>Background Reading (ppm)</u>	<u>HNU Reading (ppm)</u>	<u>Draeger Tube Reading (ppm)</u>
DGC-3	S-1	0.0- 2.0'	3:04 P	3:35 P	.9	1.2	-
	S-2	5.0- 7.0'	3:10 P	3:40 P	.4	.9	-
	S-3	10.0-12.0'	3:18 P	3:48 P	.3	.6	-
	S-4	15.0-17.0'	3:25 P	3:56 P	.3	.6	-
	S-5	20.0-22.0'	3:32 P	4:02 P	.3	.5	-
	S-6	25.0-27.0'	3:42 P	4:14 P	.4	.6	-
	S-7	30.0-32.0'	3:56 P	4:26 P	.2	.4	-
	S-8	35.0-37.0'	4:06 P	4:35 P	.3	.8	-
	S-9	40.0-42.0'	4:22 P	4:54 P	.5	1.2	-
	S-10	45.0-47.0'	4:35 P	5:05 P	.4	1.0	-
	S-11	50.0-52.0'	4:56 P	5:27 P	.4	2.2	-
	S-12	55.0-57.0'	5:14 P	5:46 P	.4	.4	-
	S-13	57.0-59.0'	11:46 A	12:16 P	.4	.4	-
	S-14	60.0-62.0'	12:41 P	1:28 P	.4	.5	-
	S-15	65.0-67.0'	1:07 P	1:40 P	.3	.3	-
DGC-3I	S-1	40.0-42.0'	No Recovery				
	S-2	42.0-44.0'	4:03 P	4:42 P	.4	.8	-
DGC-3S	S-1	25.0-27.0'	4:04 P	4:42 P	.4	.6	-
		27.0-29.0'	4:05 P	4:42 P	.3	.8	-

PHOTOIONIZATION RESULTS
383-5-2973

GE Nott St. Remedial Investigation

HNU Systems Model PI-101 Photoionization Analyzer

Dates 5/17/84 - 5/22/84

Well Cluster 4

Boring	Sample Number	Sampling Depth	Time In	Time Out	Background Reading (ppm)	HNU Reading (ppm)		Draeger Tube Reading (ppm)
						A	B	
DGC-4	S-1	0.0- 2.0'	12:20 P	12:50 P	.3	1.1	.4	-
	S-2	5.0- 7.0'	12:27 P	12:50 P	.3	.3	.4	-
	S-3	10.0-12.0'	12:32 P	12:54 P	.3	.3	.3	-
	S-4	15.0-17.0'	12:40 P	1:10 P	.3	.4	.3	-
	S-5	20.0-22.0'	12:50 P	1:21 P	.3			
	S-6	25.0-27.0'	1:00 P	1:31 P	.4	.6	.4	-
	S-7	30.0-32.0'	1:04 P	1:35 P	.3	.6	.4	-
	S-8	35.0-37.0'	1:13 P	1:43 P	.3	1.0	.6	-
	S-9	40.0-42.0'	1:21 P	1:53 P	.3	.6	.5	-
	S-10	42.0-44.0'	1:37 P	2:07 P	.3	.5	.4	-
	S-11	44.0-46.0'	1:49 P	2:17 P	.3	.5	.3	-
	S-12	46.0-48.0'	1:57 P	2:27 P	.3	.3	.3	-
	S-13	48.0-50.0'	2:11 P	2:41 P	.3	.4	.3	-
	S-14	50.0-52.0'	2:21 P	2:51 P	.3	1.8	.4	-
	S-15	55.0-57.0'	2:32 P	3:02 P	.4	.6	.4	-
	S-16	60.0-62.0'	2:54 P	3:26 P	.4	.8	.4	-
DGC-4I	S-1	29.0-31.0'	11:42 A	12:12 P	.5	1.1		-
	S-2	31.0-33.0'	11:53 A	12:23 P	.5	1.1		-
DGC-4S	S-1	12.0-14.0'	4:50 P	5:20 P	.4	.5		-

PHOTOIONIZATION RESULTS
383-5-2973

GE Nott St. Remedial Investigation

HNU Systems Model PI-101 Photoionization Analyzer

Dates 5/21/84 - 5/23/84

Well Cluster 5

Boring	Sample Number	Sampling Depth	Time In	Time Out	Background Reading (ppm)	HNU Reading (ppm)	Draeger Tube Reading (ppm)
DGC-5	S-1	0.0- 2.0'	10:33 A	11:03 A	.4	.9	-
	S-2	5.0- 7.0'	10:38 A	11:08 A	.3	.9	-
	S-3	10.0-12.0'	10:49 A	11:19 A	.4	.8	-
	S-4	15.0-17.0'	10:57 A	11:27 A	.6	1.3	-
	S-5	20.0-22.0'	11:13 A	11:34 A	.4	1.0	-
	S-6	25.0-27.0'	11:27 A	11:57 A	.4	.9	-
	S-7	30.0-32.0'	11:34 A	12:04 P	.3	1.3	-
	S-8	35.0-37.0'	11:49 A	12:19 P	.4	2.4	-
	S-9	40.0-42.0'	12:21 P	12:51 P	.4	1.7	-
	S-10	42.0-44.0'	12:21 P	12:51 P	.4	1.9	-
	S-11	44.0-46.0'	12:29 P	12:59 P	.4	2.1	-
	S-12	46.0-48.0'	12:34 P	1:04 P	.4	1.5	-
	S-13	48.0-50.0'	3:00 P	3:30 P	.3	1.0	-
	S-14	50.0-52.0'	4:20 P	4:50 P	.3	29.0	BMDL
	S-15	55.0-57.0'	4:45 P	5:15 P	.4	6.2	-
	S-16	60.0-62.0'	10:45 A	11:15 A	.4	140	-
	S-17	65.0-67.0'	10:45 A	11:15 A	.4	130	-
	S-18	70.0-72.0'	11:05 A	11:35 A	.4	21.0	-
	S-19	75.0-77.0'	11:22 A	11:52 A	.5	11.0	-
	S-20	80.0-82.0'	12:10 P	12:40 P	.4	3.4	-
	S-21	85.0-87.0'	12:10 P	12:40 P	.3	4.0	-
DGC-5I	S-1	46.5-48.5'	No Recovery				
	S-2	48.5-50.5'	11:47 A	12:17 P	.5	.6	-
DGC-5S	S-1	26.0-28.0'	11:04 A	11:36 A	.5	24.0	BMDL

PHOTOIONIZATION RESULTS
383-5-2973

GE Nott St. Remedial Investigation

HNU Systems Model PI-101 Photoionization Analyzer

Dates 5/24/84

Well Cluster 6

Boring	Sample Number	Sampling Depth	Time In	Time Out	Background Reading (ppm)	HNU Reading (ppm)	Draeger Tube Reading (ppm)	
DGC-6	S-1	0.0- 2.0'	9:18 A	9:48 A	.5	2.5	-	
	S-2	2.0- 4.0'	9:21 A	9:51 A	.5	1.4	-	
	S-3	4.0- 6.0'	9:27 A	9:57 A	.4	.7	-	
	S-4	6.0- 8.0'	9:28 A	9:58 A	.2	.7	-	
	S-5	8.0-10.0'	9:36 A	10:06 A	.5	1.2	-	
	S-6	10.0-12.0'	9:41 A	10:11 A	.2	1.6	-	
	S-7	12.0-14.0'	9:57 A	10:27 A	.4	1.4	-	
	S-8	14.0-16.0'	10:00 A	10:30 A	.2	4.2	BMDL	
	S-9	16.0-18.0'	10:06 A	10:36 A	.2	1.0	-	
	S-10	18.0-20.0'	No Recovery					
	S-11	20.0-22.0'	10:19 A	10:49 A	.4	1.4	-	
	S-12	22.0-24.0'	10:25 A	10:55 A	.2	.8	-	
	S-13	24.0-26.0'	11:00 A	11:30 A	.3	4.4	BMDL	
	S-14	26.0-28.0'	11:09 A	11:39 A	.3	1.8	-	
	S-15	28.0-30.0'	11:23 A	11:53 A	.3	1.2	-	
	S-16	30.0-32.0'	11:31 A	12:01 P	.4	2.6	-	
	S-17	32.0-34.0'	11:45 A	12:15 P	.4	1.1	-	
	S-18	34.0-36.0'	11:55 A	12:25 P	.3	1.4	-	
	S-19	36.0-38.0'	12:08 P	12:38 P	.6	1.4	-	
	S-20	38.0-40.0'	12:16 P	12:46 P	.3	1.2	-	
	S-21	40.0-42.0'	1:22 P	1:52 P	.4	1.0	-	
	S-22	42.0-44.0'	1:28 P	1:58 P	.2	.4	-	
	S-23	44.0-46.0'	1:47 P	2:17 P	.4	.8	-	
	S-24	46.0-48.0'	1:52 P	2:22 P	.3	.8	-	
	S-25	48.0-50.0'	2:07 P	2:37 P	.5	1.2	-	
	S-26	50.0-52.0'	2:17 P	2:47 P	.3	2.7	-	
	S-27	52.0-54.0'	2:27 P	2:57 P	.9	1.8	-	
	S-28	54.0-56.0'	2:31 P	3:01 P	.4	.9	-	
	S-29	56.0-58.0'	3:00 P	3:30 P	.9	1.2	-	
	S-30	58.0-60.0'	3:10 P	3:40 P	.9	60	BMDL	

<u>Boring</u>	<u>Sample Number</u>	<u>Sampling Depth</u>	<u>Time In</u>	<u>Time Out</u>	<u>Background Reading (ppm)</u>	<u>HNU Reading (ppm)</u>	<u>Draeger Tube Reading (ppm)</u>
DGC-6	S-31	60.0-62.0'	3:21 P	3:51 P	.6	1.8	-
	S-32	62.0-64.0'	3:30 P	4:00 P	.3	1.8	-
	S-33	64.0-66.0'	4:16 P	4:46 P	.6	2.0	-
	S-34	66.0-68.0'	4:39 P	5:09 P	.2	.6	-
	S-35	68.0-70.0'	4:46 P	5:19 P	.2	.4	-
	S-36	70.0-72.0'	5:10 P	5:40 P	.5	1.4	-
	S-37	72.0-74.0'	5:10 P	5:40 P	.2	.7	-
	S-38	74.0-76.0'	5:23 P	5:53 P	.2	.7	-
	S-39	76.0-78.0'	9:51 A	10:21 A	2.3	1.8	-
	S-40	78.0-80.0'	9:52 A	10:22 A	1.8	1.2	-
	S-41	80.0-82.0'	9:53 A	10:23 A	2.0	1.3	-
	S-42	82.0-84.0'	9:55 A	10:25 A	1.0	1.2	-
	S-43	84.0-86.0'	9:23 A	9:53 A	2.7	2.7	-
	S-44	86.0-88.0'	9:26 A	9:56 A	2.3	2.8	-
	S-45	88.0-90.0'	9:00 A	9:30 A	2.0	2.3	-
	S-46	90.0-92.0'	9:04 A	9:34 A	1.8	2.6	-
	S-47	92.0-94.0'	10:54 A	11:24 A	.6	.8	-
	S-48	94.0-96.0'	11:04 A	11:34 A	1.1	1.6	-
	S-49	96.0-98.0'	11:30 A	12:00 P	1.8	4.0	BMDL
	S-50	98.0-100.0'	11:36 A	12:06 P	1.1	2.4	-
	S-51	100.0-102.0'	12:00 P	12:30 P	1.2	2.8	-
	S-52	102.0-104.0'	12:18 P	12:50 P	1.2	1.6	-
DGC-6I	S-1	50.0-52.0'	11:48 A	12:18 P	.6	2.9	-
DGC-6S	S-1	29.0-31.0'	11:32 A	12:02 P	.7	5.0	-

PHOTOIONIZATION RESULTS
383-5-2973

GE Nott St. Remedial Investigation

HNU Systems Model PI-101 Photoionization Analyzer

Dates 5/24/84 - 6/1/84

Well Cluster 7.

Boring	Sample Number	Sampling Depth	Time In	Time Out	Background Reading (ppm)	HNU Reading (ppm)	Draeger Tube Reading (ppm)
DGC-7	S-1	0.0- 2.0'	11:00 A	11:30 A	.2	27.0	BMDL
	S-2	5.0- 7.0'	11:00 A	11:30 A	.4	1.2	-
	S-3	10.0-12.0'	11:00 A	11:30 A	.4	1.0	-
	S-4	15.0-17.0'	11:00 A	11:30 A	.3	1.2	-
	S-5	20.0-22.0'	11:00 A	11:30 A	.3	2.8	-
	S-6	25.0-27.0'	11:00 A	11:30 A	.3	1.9	-
	S-7	30.0-32.0'	11:00 A	11:30 A	.3	2.0	-
	S-8	35.0-37.0'	11:00 A	11:30 A	.4	1.0	-
	S-9	40.0-42.0'	11:00 A	11:30 A	.3	5.2	BMDL
	S-10	45.0-47.0'	11:38 A	12:08 P	.4	6.8	BMDL
	S-11	50.0-52.0'	11:38 A	12:08 P	.4	2.6	-
	S-12	55.0-57.0'	4:05 P	4:35 P	.3	56	60
	S-13	60.0-62.0'	4:29 P	4:59 P	.4	24	7.0
	S-14	65.0-67.0'	5:10 P	5:40 P	.3	6.0	2.0
	S-15	70.0-72.0'	5:10 P	5:40 P	.2	2.2	-
	S-16	75.0-77.0'	9:44 A	10:14 A	.6	1.2	-
	S-17	80.0-82.0'	9:47 A	10:17 A	.8	2.9	-
	S-18	85.0-87.0'	9:49 A	10:19 A	2.0	3.4	-
	S-19	90.0-92.0'	9:50 A	10:20 A	2.0	2.4	-
DGC-7I	S-1	46.0-48.0'	11:30 A	12:00 P	1.7	12.0	2.0
DGC-7S	S-1	30.0-32.0'	11:30 A	12:00 P	1.4	3.4	-

PHOTOIONIZATION RESULTS
383-5-2973

GE Nott St. Remedial Investigation

HNU Systems Model PI-101 Photoionization Analyzer

Dates 6/5/84 - 6/7/84

Well Cluster 8

<u>Boring</u>	<u>Sample Number</u>	<u>Sampling Depth</u>	<u>Time In</u>	<u>Time Out</u>	<u>Background Reading (ppm)</u>	<u>HNU Reading (ppm)</u>	<u>Draeger Tube Reading (ppm)</u>
DGC-8	S-1	0.0- 2.0'	10:03 A	10:33 A	.8	6.2	-
	S-2	5.0- 7.0'	10:03 A	10:33 A	.8	5.6	-
	S-3	10.0-12.0'	10:03 A	10:33 A	.8	6.6	-
	S-4	15.0-17.0'	10:03 A	10:33 A	.8	6.3	-
	S-5	20.0-22.0'	10:03 A	10:33 A	.8	5.4	-
	S-6	25.0-27.0'	10:11 A	10:41 A	.7	7.6	-
	S-7	30.0-32.0'	10:18 A	10:48 A	.8	6.5	-
	S-8	35.0-37.0'	10:30 A	11:00 A	.8	7.2	BMDL
	S-9	40.0-42.0'	10:48 A	11:18 A	1.2	4.2	-
	S-10	45.0-47.0'	11:35 A	12:05 P	1.0	4.2	-
	S-11	50.0-52.0'	11:40 A	12:10 P	.8	5.2	-
	S-12	55.0-57.0'	11:52 A	12:22 P	.7	7.2	BMDL
	S-13	60.0-62.0'	1:43 P	2:13 P	.8	5.7	BMDL
	S-14	65.0-67.0'	1:55 P	2:25 P	.7	5.0	-
	S-15	70.0-72.0'	2:18 P	2:48 P	1.0	4.9	BMDL
	S-16	75.0-77.0'	2:30 P	3:00 P	.9	5.2	-
	S-17	80.0-82.0'	3:05 P	3:35 P	.4	2.7	-
	S-18	85.0-87.0'	10:15 A	10:45 A	.4	2.4	-
	S-19	90.0-92.0'	10:15 A	10:45 A	1.4	2.3	-
	S-20	95.0-97.0'	10:15 A	10:45 A	.4	.6	-
	S-21	100.0-102.0'	10:15 A	10:45 A	.4	.4	-
	S-22	108.0-107.0'	10:15 A	10:45 A	1.3	1.6	-
	S-23	107.0-109.0'	10:15 A	10:45 A	1.3	1.7	-
DGC-8I	S-1	51.0-53.0'	4:15 P	4:45 P	2.0	.5	-
DGC-8S	S-1	31.0-33.0'	9:20 A	9:50 A	3.2	4.2	-

PHOTOIONIZATION RESULTS
383-5-2973

GE Nott St. Remedial Investigation

HNU Systems Model PI-101 Photoionization Analyzer

Dates 6/5/84 - 6/6/84

Well Cluster 9

<u>Boring</u>	<u>Sample Number</u>	<u>Sampling Depth</u>	<u>Time In</u>	<u>Time Out</u>	<u>Background Reading (ppm)</u>	<u>HNU Reading (ppm)</u>	<u>Draeger Tube Reading (ppm)</u>
DGC-9	S-1	0.0- 2.0'					
	S-2	5.0- 7.0'	1:08 P	1:38 P	.4	1.7	-
	S-3	10.0-12.0'	1:10 P	1:40 P	.6	2.6	-
	S-4	15.0-17.0'	1:10 P	1:40 P	.6	3.1	-
	S-5	20.0-22.0'	1:10 P	1:40 P	.6	3.0	-
	S-6	25.0-27.0'	1:10 P	1:40 P	.5	2.7	-
	S-7	30.0-32.0'	1:10 P	1:40 P	.4	4.9	BMDL
	S-8	35.0-37.0'	1:10 P	1:40 P	.4	2.5	-
	S-9	40.0-42.0'	1:10 P	1:40 P	.4	3.0	-
	S-10	45.0-47.0'	1:10 P	1:40 P	.4	2.0	-
	S-11	50.0-52.0'	1:10 P	1:40 P	.5	2.0	-
	S-12	55.0-57.0'	1:21 P	1:51 P	.4	4.4	2.0
	S-13	60.0-62.0'	1:30 P	2:00 P	.4	3.5	-
	S-14	65.0-67.0'	1:48 P	2:13 P	.4	3.7	-
	S-15	70.0-72.0'	2:01 P	2:31 P	.6	1.0	-
	S-16	75.0-77.0'	2:42 P	3:12 P	.5	3.4	-
DGC-9I	S-1	36.0-38.0'	4:15 P	4:45 P	1.8	2.0	-
DGC-9S	S-1	33.0-35.0'	9:20 A	9:50 A	3.4	3.8	-

PHOTOIONIZATION RESULTS
383-5-2973

GE Nott St. Remedial Investigation

HNU Systems Model PI-101 Photoionization Analyzer

Dates 6/7/84 - 6/12/84

Well Cluster 10

<u>Boring</u>	<u>Sample Number</u>	<u>Sampling Depth</u>	<u>Time In</u>	<u>Time Out</u>	<u>Background Reading (ppm)</u>	<u>HNU Reading (ppm)</u>	<u>Draeger Tube Reading (ppm)</u>
DGC-10	S-1	0.0- 2.0'	4:25 P	4:55 P	3.6	2.6	-
	S-2	5.0- 7.0'	4:25 P	4:55 P	2.6	2.9	-
	S-3	10.0-12.0'	4:25 P	4:55 P	2.6	2.9	-
	S-4	15.0-17.0'	4:25 P	4:55 P	2.2	2.7	-
	S-5	20.0-22.0'	4:25 P	4:55 P	2.6	2.8	-
	S-6	25.0-27.0'	4:25 P	4:55 P	2.4	2.9	-
	S-7	30.0-32.0'	4:25 P	4:55 P	2.6	2.8	-
	S-8	35.0-37.0'	4:25 P	4:55 P	2.5	6.2	BMDL
	S-9	40.0-42.0'	4:25 P	4:55 P	2.5	11.2	2.0
	S-10	45.0-47.0'	4:25 P	4:55 P	2.3	3.4	-
	S-11	50.0-52.0'	4:25 P	4:55 P	2.2	2.9	-
	S-12	55.0-57.0'	4:25 P	4:55 P	2.3	2.8	-
	S-13	60.0-62.0'	4:25 P	4:55 P	2.2	1.6	-
DGC-10I	S-1	34.0-36.0'	11:18 A	11:48 A	.9	2.5	-
DGC-10S	S-1	26.0-28.0'	9:30 A	10:00 A	.8	3.2	BMDL

PHOTOIONIZATION RESULTS
383-5-2973

GE Nott St. Remedial Investigation

HNU Systems Model PI-101 Photoionization Analyzer

Dates 6/7/84 - 6/17/84

Well Cluster 11

<u>Boring</u>	<u>Sample Number</u>	<u>Sampling Depth</u>	<u>Time In</u>	<u>Time Out</u>	<u>Background Reading (ppm)</u>	<u>HNU Reading (ppm)</u>	<u>Draeger Tube Reading (ppm)</u>
DGC-11	S-1	0.0- 2.0'	2:15 P	2:45 P	3.2	3.5	-
	S-2	2.0- 4.0'	2:15 P	2:45 P	3.0	3.2	-
	S-3	4.0- 6.0'	2:15 P	2:45 P	3.2	3.8	-
	S-4	6.0- 8.0'	2:15 P	2:45 P	3.1	3.8	BMDL
	S-5	8.0-10.0'	2:15 P	2:45 P	3.2	3.3	-
	S-6	10.0-12.0'	2:15 P	2:45 P	3.0	3.3	-
	S-7	12.0-14.0'	2:17 P	2:47 P	3.1	3.3	-
	S-8	14.0-16.0'	2:21 P	2:51 P	2.7	3.5	-
	S-9	16.0-18.0'	2:45 P	3:15 P	2.9	3.5	-
	S-10	18.0-20.0'	2:45 P	3:15 P	3.0	3.3	-
	S-11	20.0-22.0'	2:45 P	3:15 P	3.0	3.1	-
	S-12	22.0-24.0'	2:45 P	3:15 P	3.0	3.2	-
	S-13	24.0-26.0'	2:57 P	3:27 P	3.0	4.2	-
	S-14	26.0-28.0'	3:03 P	3:33 P	3.2	3.9	-
	S-15	28.0-30.0'	4:35 P	5:05 P	2.0	5.3	BMDL
	S-16	30.0-32.0'	4:35 P	5:05 P	2.3	4.2	BMDL
	S-17	32.0-34.0'	4:35 P	5:05 P	2.2	3.8	-
	S-18	34.0-36.0'	4:35 P	5:05 P	2.3	3.7	-
	S-19	36.0-38.0'	4:35 P	5:05 P	2.3	4.7	-
	S-20	38.0-40.0'	4:35 P	5:05 P	2.4	6.3	2.0
	S-21	40.0-42.0'	4:35 P	5:05 P	2.4	3.5	-
	S-22	42.0-44.0'	4:35 P	5:05 P	2.4	3.9	-
	S-23	44.0-46.0'	5:11 P	5:41 P	2.5	4.7	BMDL
	S-24	46.0-48.0'	5:11 P	5:41 P	1.8	7.0	BMDL
	S-25	48.0-50.0'	5:18 P	5:48 P	1.5	4.2	2.0
	S-25A	48.0-50.0'	5:18 P	5:48 P	2.2	5.4	BMDL
	S-26	50.0-52.0'	5:40 P	6:10 P	1.7	5.2	-
	S-27	52.0-54.0'	8:06 A	8:36 A	1.3	2.3	-
	S-28	54.0-56.0'	8:24 A	8:54 A	.5	1.6	-
	S-29	56.0-58.0'	8:27 A	8:57 A	.5	3.2	2.0
S-30	58.0-60.0'	8:36 A	9:06 A	.5	2.3	30.0	

<u>Boring</u>	<u>Sample Number</u>	<u>Sampling Depth</u>	<u>Time In</u>	<u>Time Out</u>	<u>Background Reading (ppm)</u>	<u>HNU Reading (ppm)</u>	<u>Draeger Tube Reading (ppm)</u>
DGC-11	S-31	60.0-62.0'	8:48 A	9:18 A	1.0	7.1	3.0
	S-32	62.0-64.0'	8:57 A	9:27 A	.8	1.6	-
	S-33	64.0-66.0'	9:11 A	9:41 A	.8	13.2	10
	S-34	66.0-68.0'	9:19 A	9:49 A	.8	18.6	8.0
	S-35	68.0-70.0'	9:35 A	10:05 A	.7	9.0	5.0
	S-36	70.0-72.0'	9:45 A	10:15 A	.7	2.6	-
	S-37	72.0-74.0'	9:57 A	10:27 A	.6	20+	25
	S-38	74.0-76.0'	8:24 A	8:54 A	.7	28	20
	S-39	76.0-78.0'	8:24 A	8:56 A	.8	12	2.0
	S-40	78.0-80.0'	9:20 A	9:50 A	.9	3.2	BMDL
	S-41	80.0-82.0'	9:31 A	10:01 A	.8	4.9	BMDL
	S-42	82.0-84.0'	9:50 A	10:20 A	2.5	2.6	-
	S-43	84.0-86.0'	10:06 A	10:36 A	1.8	2.3	-
	S-44	86.0-88.0'	10:20 A	10:50 A	.7	2.9	-
	S-45	88.0-90.0'	10:33 A	11:03 A	1.8	3.0	-
	S-46	90.0-92.0'	11:03 A	11:33 A	.5	2.2	-
	S-47	92.0-94.0'	11:07 A	11:37 A	1.0	2.1	-
	S-48	94.0-96.0'	12:37 P	1:07 P	.8	2.8	-
DGC-11I	S-1	46.0-48.0'	11:03 A	11:35 A	.9	3.8	BMDL
DGC-11S	S-1	31.0-33.0'	10:35 A	11:05 A	2.3	4.1	BMDL

PHOTOIONIZATION RESULTS
383-5-2973

GE Nott St. Remedial Investigation

HNU Systems Model PI-101 Photoionization Analyzer

Dates 6/13/84 - 6/15/84

Well Cluster 12

<u>Boring</u>	<u>Sample Number</u>	<u>Sampling Depth</u>	<u>Time In</u>	<u>Time Out</u>	<u>Background Reading (ppm)</u>	<u>HNU Reading (ppm)</u>	<u>Draeger Tube Reading (ppm)</u>
DGC-12	S-1	0.0- 2.0'	7:55 A	8:25 A	1.8	2.2	-
	S-2	5.0- 7.0'	7:55 A	8:25 A	1.7	2.2	-
	S-3	10.0-12.0'	7:55 A	8:25 A	1.8	2.1	-
	S-4	15.0-17.0'	7:55 A	8:25 A	1.7	2.0	-
	S-5	20.0-22.0'	7:55 A	8:25 A	1.7	2.0	-
	S-6	25.0-27.0'	8:05 A	8:35 A	1.7	1.8	-
	S-7	30.0-32.0'	8:05 A	8:35 A	.6	.7	-
	S-8	35.0-37.0'	9:26 A	9:56 A	.9	3.0	BMDL
	S-9	40.0-42.0'	9:26 A	9:56 A	1.2	2.3	-
	S-10	45.0-47.0'	9:26 A	9:56 A	.8	1.5	-
	S-11	50.0-52.0'	9:30 A	10:00 A	1.5	2.7	-
	S-12	55.0-57.0'	9:30 A	10:00 A	1.3	2.2	-
	S-13	60.0-62.0'	9:30 A	10:00 A	1.0	1.0	-
	S-14	65.0-67.0'	10:25 A	10:55 A	1.4	2.7	-
DGC-12I	S-1	33.0-35.0'	2:05 P	2:35 P	.8	2.2	2.0
	S-2	35.0-37.0'	2:05 P	2:36 P	.8	1.8	BMDL
	S-3	37.0-39.0'	2:09 P	2:37 P	.8	1.6	BMDL
DGC-12S	S-1	21.0-23.0'	11:05 A	11:35 A	1.2	6.0	-
	S-2	23.0-25.0'	11:06 A	11:36 A	1.2	3.6	-
	S-3	25.0-27.0'	11:07 A	11:37 A	1.2	4.8	-

PHOTOIONIZATION RESULTS
383-5-2973

GE Nott St. Remedial Investigation

HNU Systems Model PI-101 Photoionization Analyzer

Dates 6/19/84

Well Cluster 13

<u>Boring</u>	<u>Sample Number</u>	<u>Sampling Depth</u>	<u>Time In</u>	<u>Time Out</u>	<u>Background Reading (ppm)</u>	<u>HNU Reading (ppm)</u>	<u>Draeger Tube Reading (ppm)</u>
DGC-13	S-1	0.0- 2.0'	4:04 P	4:34 P	1.2	8.0	BMDL
	S-2	5.0- 7.0'	4:04 P	4:34 P	5.0	.8	BMDL
	S-3	10.0-12.0'	4:04 P	4:34 P	4.8	.9	-

Horizontal Hydraulic Conductivity
Field Results

<u>Well I.D.</u>	<u>Test Type/No.</u>	<u>K cm/sec</u>	<u>K ft/day</u>
3I	Bail/1	7.8×10^{-2}	2.2×10^2
3I	Slub/1	2.1×10^{-2}	6.0×10^1
3D	Bail/2	2.0×10^{-2}	5.6×10^1
3D	Slug/1	1.4×10^{-2}	3.8×10^1
4I	Bail/1	3.4×10^{-2}	9.8×10^1
4I	Slug/1	9.9×10^{-3}	2.8×10^1
4D	Bail/2	1.1×10^{-2}	3.1×10^1
4D	Slug/1	6.8×10^{-3}	1.9×10^1
5I	Slug/1	3.7×10^{-3}	1.1×10^1
5D	Bail/1	6.3×10^{-3}	1.8×10^1
5D	Slug/1	1.9×10^{-3}	5.5×10^0
8I	Bail/2	2.3×10^{-2}	6.4×10^1
8I	Slug/1	8.1×10^{-3}	2.3×10^1
8D	Bail/2	1.1×10^{-2}	3.2×10^1
8D	Slug/1	2.8×10^{-3}	7.9×10^0
10I	Bail/2	3.6×10^{-3}	1.0×10^1
10I	Slug/1	2.8×10^{-3}	8.0×10^0
10D	Bail/2	2.5×10^{-3}	7.1×10^0
10D	Slug/1	2.4×10^{-3}	6.9×10^0
11I	Bail/1	2.0×10^{-2}	5.6×10^1
11I	Slug/1	2.6×10^{-3}	7.4×10^0
11D	Bail/2	5.7×10^{-3}	1.6×10^1
11D	Slug/1	2.1×10^{-3}	5.8×10^0

Vertical Hydraulic Conductivity
Falling Head Field Test

<u>Well I.D.</u>	<u>Depth of test (ft)</u>	<u>K (cm/sec)</u>	<u>K (ft/day)</u>	<u>Stratigraphic Unit</u>
DGC 1D	64	3.3×10^{-3}	9.4	UGL
DGC 1I	46.5	1.8×10^{-5}	5.1×10^{-2}	GD
DGC 1S	28.1	4.6×10^{-4}	1.3	GD
DGC 2I	40.8	9.3×10^{-3}	2.6	GD
DGC 2S	25	6.4×10^{-5}	.18	GD
DGC 3D	58	1.8×10^{-3}	5.1	UGL
DGC 3I	40.5	4.8×10^{-4}	1.4	GD
DGC 3S	22	6.2×10^{-4}	1.8	GD
DGC 4S	12	6.9×10^{-5}	.20	GD
DGC 5D	50.5	2.3×10^{-5}	6.5×10^{-2}	GD
DGC 5I	45	4.1×10^{-3}	12	GD
DGC 5S	26	1.5×10^{-5}	4.3×10^{-2}	GD
DGC 6D	86	4.0×10^{-6}	1.1×10^{-2}	UGL
DGC 6I	49	2.8×10^{-5}	8.0×10^{-2}	GD
DGC 6S	30	2.0×10^{-2}	57	GD
DGC 7D	58	1.5×10^{-3}	4.3	GD
DGC 7I	50	1.9×10^{-4}	.54	GD
DGC 7S	30	3.8×10^{-5}	.11	GD
DGC 8D	85.5	6.2×10^{-6}	1.8×10^{-2}	UGL
DGC 8I	51	4.4×10^{-6}	1.2×10^{-2}	GD
DGC 8S	31	9.0×10^{-6}	2.6×10^{-2}	GD
DGC 9I	37	2.9×10^{-5}	8.2×10^{-2}	GD
DGC 9S	33	1.3×10^{-4}	.37	GD
DGC 10S	26	3.6×10^{-3}	10	GD
DGC 11D	74.5	3.7×10^{-6}	1.0×10^{-2}	GD

<u>Well I.D.</u>	<u>Depth of test (ft)</u>	<u>K (cm/sec)</u>	<u>K (ft/day)</u>	<u>Stratigraphic Unit</u>
GC 11I	46	1.5×10^{-3}	4.3	GD
DGC 11S	32	5.2×10^{-6}	1.5×10^{-2}	GD
GC 12L	33	1.3×10^{-5}	3.7×10^{-2}	GD
DGC 12S	19	9.2×10^{-6}	2.6×10^{-2}	GD

GD - Glaciodeltaic

UGL - Upper Glaciolacustrine

Mean (GD) = 1.6×10^{-3} cm/sec = 4.5 ft/day

Mean (UGL) = 1.3×10^{-3} cm/sec = 3.7 ft/day

<u>Boring Number</u>	<u>Interval</u>	<u>Head (psi)</u>	<u>K_v (cm/sec)</u>
DGC-14	102.5' - 104.5'	5.0	5.12×10^{-7}
	102.5' - 104.5'	10.0	5.10×10^{-7}
DGC-15	92.0' - 93.5'	0.4	1.66×10^{-4}
	Upper part of tube	1.0	1.79×10^{-4}
DGC-15	92.0' - 93.5'	1.0	1.18×10^{-5}
	Lower part of tube	2.0	1.23×10^{-5}

FLOW VOLUME - ΔV (cm³)

TIME - t (sec)

5,000

10,000

15,000

$\Delta V/t$ RELATIONSHIP

$\Delta V/t = 8.86 \times 10^{-4} \text{ cm}^3/\text{sec}$
@ $\Delta h = 5.0 \text{ psi}$

$\Delta V/t = 1.76 \times 10^{-3} \text{ cm}^3/\text{sec}$
@ $\Delta h = 10.0 \text{ psi}$

PERMEABILITY - k (cm/sec)

PERMEABILITY

HYDRAULIC GRADIENT - $\Delta h/L$ (cm/cm)

TEST DATA:

TYPE OF PERMEAMETER	Constant Head, Triaxial	
SPECIMEN HEIGHT (cm)	8.37	
SPECIMEN DIAMETER (cm)	7.24	
DRY UNIT WEIGHT (pcf)	100.3	
MOISTURE CONTENT BEFORE TEST (%)	28.0	
MOISTURE CONTENT AFTER TEST (%)	25.1	
MAXIMUM DRY DENSITY (ASTM D) (pcf)		
OPTIMUM MOISTURE CONTENT (%)		
CELL CONFINING PRESSURE (psi)	120.0	120.0
TEST PRESSURE (psi)	85.0	90.0
BACK PRESSURE (psi)	80.0	80.0
DIFFERENTIAL HEAD (psi)	5.0	10.0
PERMEABILITY (cm/sec)	5.12×10^{-7}	5.10×10^{-7}

SAMPLE IDENTIFICATION:

Boring No. DGC-14 (102.5'-104.5')

VISUAL DESCRIPTION: Grey SILT & CLAY, seams of fine Sand. Partially cemented



EMPIRE SOILS INVESTIGATIONS, INC.

PERMEABILITY TEST REPORT

GENERAL ELECTRIC, NOTT STREET SITE
MOREAU, NEW YORK

DATE: Sept. 1984

PROJ. NO. GT-84-96

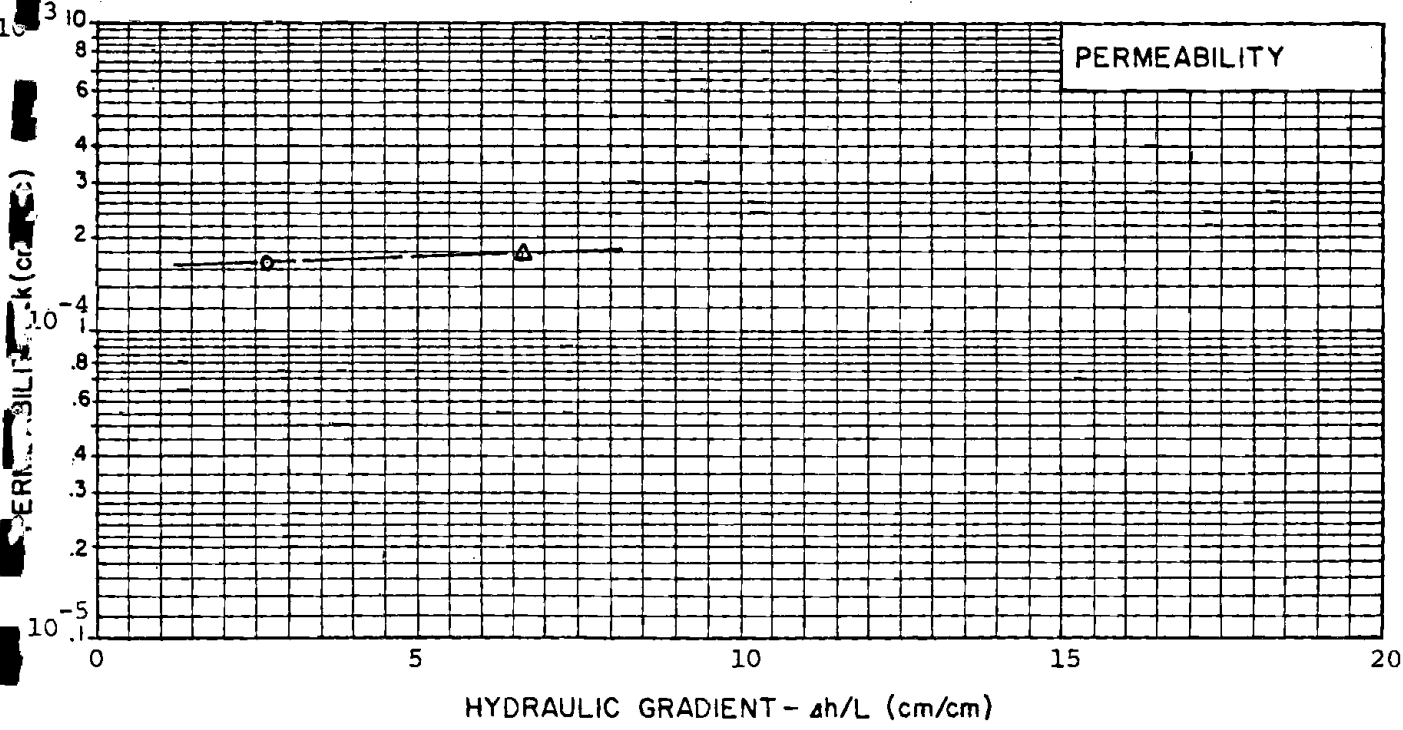
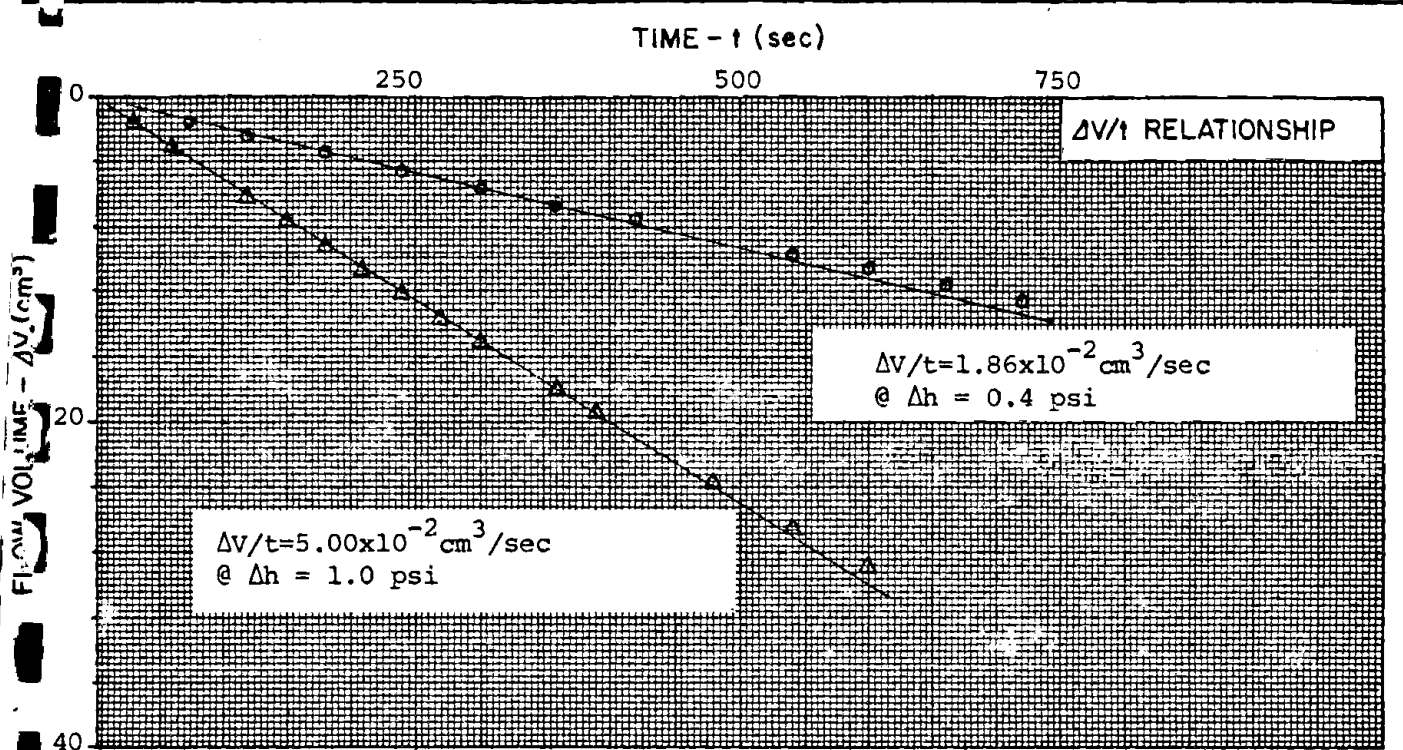

TEST DATA:

TYPE OF PERMEAMETER	Constant Head, Triaxial	
SPECIMEN HEIGHT (cm)	10.52	
SPECIMEN DIAMETER (cm)	7.30	
DRY UNIT WEIGHT (pcf)	104.7	
MOISTURE CONTENT BEFORE TEST (%)	24.6	
MOISTURE CONTENT AFTER TEST (%)	22.7	
MAXIMUM DRY DENSITY (ASTM D _____) (pcf)		
OPTIMUM MOISTURE CONTENT (%)	120.0	120.0
CELL CONFINING PRESSURE (psi)	80.4	81.0
TEST PRESSURE (psi)	80.0	80.0
BACK PRESSURE (psi)	0.4	1.0
DIFFERENTIAL HEAD (psi)	1.66×10^{-4}	1.79×10^{-4}
PERMEABILITY (cm/sec)		

SAMPLE IDENTIFICATION:
Boring No. DGC-15 (92.0'-93.5')
Upper Part of Tube

VISUAL DESCRIPTION: Fine Grey SAND

 **EMPIRE SOILS INVESTIGATIONS, INC.**

PERMEABILITY TEST REPORT

GENERAL ELECTRIC, NOTT STREET SITE
MOREAU, NEW YORK

DATE: Sept, 1984	PROJ. NO.: GT-84-96
------------------	---------------------

FLUID VOLUME - 4 cm^3
 PERMEABILITY - 10^{-4} cm/sec

TIME - t (sec)

2,000

4,000

6,000

$\Delta V/t$ RELATIONSHIP

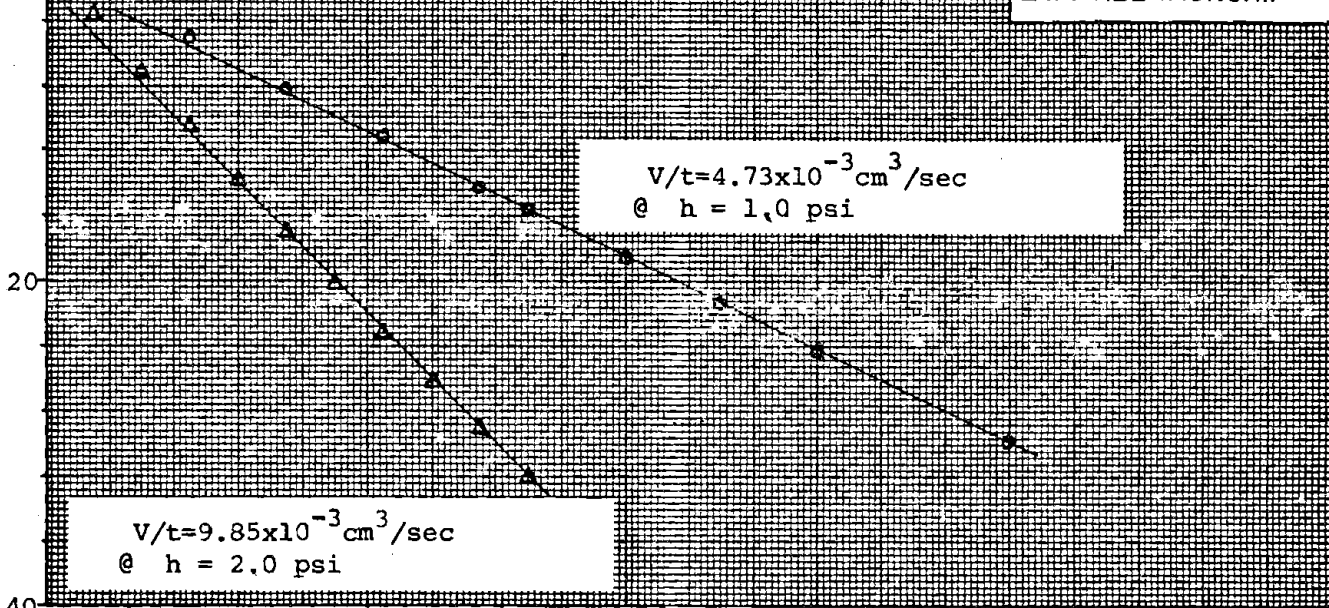

PERMEABILITY

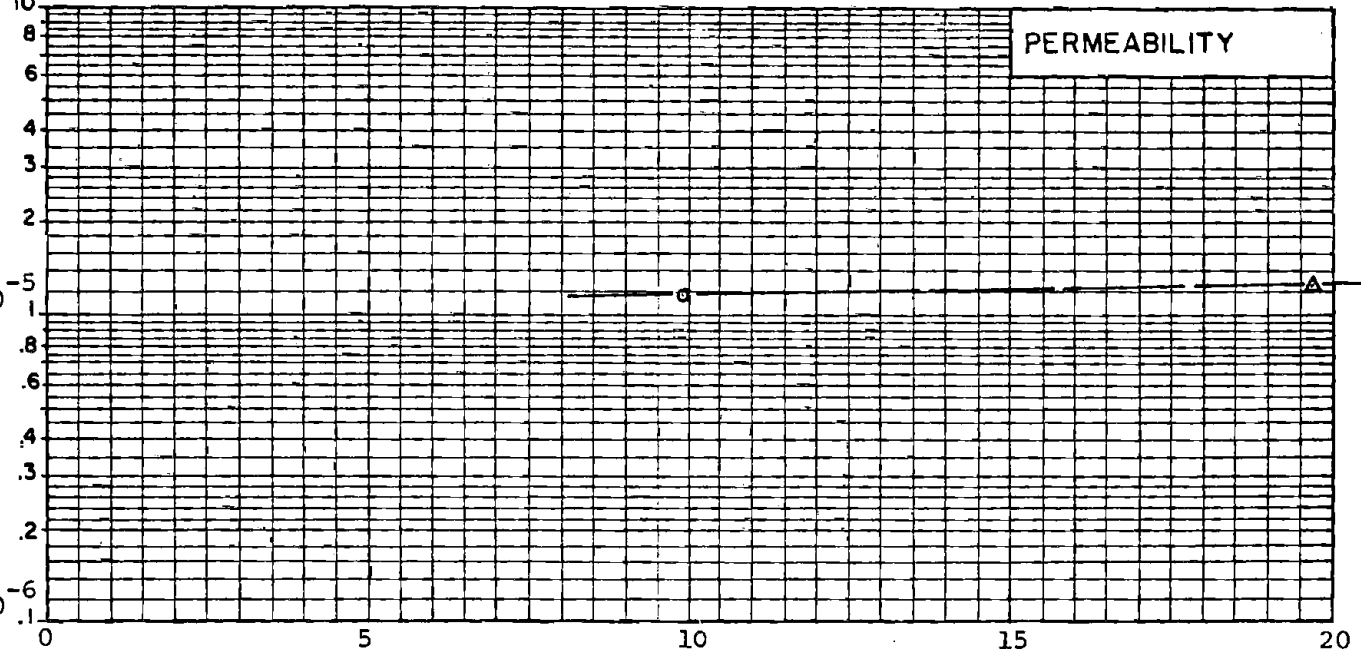

HYDRAULIC GRADIENT - $\Delta h/L$ (cm/cm)

TEST DATA:

TYPE OF PERMEAMETER	Constant Head, Triaxial	
SPECIMEN HEIGHT (cm)	7.12	
SPECIMEN DIAMETER (cm)	7.19	
DRY UNIT WEIGHT (pcf)	108.3	
MOISTURE CONTENT BEFORE TEST (%)	21.3	
MOISTURE CONTENT AFTER TEST (%)	20.4	
MAXIMUM DRY DENSITY (ASTM D _____) (pcf)		
OPTIMUM MOISTURE CONTENT (%)		
CELL CONFINING PRESSURE (psi)	120.0	120.0
TEST PRESSURE (psi)	81.0	82.0
BACK PRESSURE (psi)	80.0	80.0
DIFFERENTIAL HEAD (psi)	1.0	2.0
PERMEABILITY (cm/sec)	1.18×10^{-5}	1.23×10^{-5}

SAMPLE IDENTIFICATION:

Boring No. DGC-15 (92.0'-93.5')
Lower Part of Tube

VISUAL DESCRIPTION: Grey SILT, partially cemented, fissured



EMPIRE SOILS INVESTIGATIONS, INC.

PERMEABILITY TEST REPORT

GENERAL ELECTRIC, NOTT STREET SITE
MOREAU, NEW YORK

DATE: Sept. 1984

PROJ. NO.: GT-84-96

GENERAL ELECTRIC

TURBINE BUSINESS GROUP

GENERAL ELECTRIC COMPANY SCHENECTADY, NEW YORK 12345
Phone (518) 385-2211

May 2, 1984

53-10-21-
10 372-

Ms. Nancy Stewart
ERCO/Energy Resources Co., Inc.
Environmental Sciences Division
205 Alewife Brook Parkway
Cambridge, Mass. 02138

Dear Nancy:

Attached is the New York State Department of Health procedure for the analysis of volatile organic compounds in soil. As I mentioned, the only change is in the sample container - samples are now collected in the standard 40 ml. vials used for water samples. Consequently, the hole in the block heater has to be enlarged a bit.

Please call me just as soon as you have had an opportunity to review the procedure.

Sincerely yours,



D. W. MAGEE, Manager
Environmental Quality Planning

DWM/aeo

cc: D. T. Clark, Dunn Geoscience
T. L. Collins

RECEIVED
MAY 3 1984

DUNN GEOSCIENCE
CORPORATION

Volatile Halo-organics in Soil

TENTATIVE

1. SCOPE AND APPLICATION:

1.1 This method is applicable to the determination of the following compounds in soil:

- chloroform
- trichloroethene
- tetrachloroethene
- 1,1,1-trichloroethane
- 1,1,2-trichloroethane,
- Carbon tetrachloride
- Benzene *
- Toluene *
- Xylenes *
- Chlorotoluenes *

* Will be purged and trapped but must be measured with a photoionization detector.

1.2 The method may be extended to other compounds. However, verification for each additional compound is necessary.

1.3 The source of the sample may pose varying levels of difficulty. The analyst is encouraged to validate the method with the soil type being tested. The use of this method is recommended with this understanding.

2. SUMMARY OF METHOD

Halo-organics are liberated from soil by pumping air through a closed vessel containing the sample which is heated at 130°C. The halo-organics are adsorbed on Porapak^K-N, then eluted with methanol. The eluate is analyzed by gas chromatography using either an electron capture or a

halogen specific detector.

3. INTERFERENCES

The technique described may liberate compounds from the soil samples in addition to those which are specified. The additional compounds detected will depend upon the volatility of the substance as well as a number of other factors. The analyst must be aware of these potential interferences and take the necessary steps to eliminate or minimize them.

4. APPARATUS AND MATERIALS

- 4.1 Glass tubes with septum closures and crimp tops
- 4.2 Pyrex tubing - 1/4'' O.D.
- 4.3 Steel bellows pump - model MB41, Metal Bellows Corp., Sharon, MA.,
(including 1/4'' male pipe thread to 1/16'' Swagelok fitting) ~ \$300
- 4.4 Block heater
- 4.5 Swagelok fittings - various sizes
- 4.6 Soft steel tubing 1/16'' O.D.
- 4.7 Gas chromatograph equipped with electron capture detector or halogen specific detector
- 4.8 Test tubes - 5 or 10 ml, graduated at 0.1 ml intervals
- 4.9 Glass syringe - 10 μ l, 100 μ l
- 4.10 Volumetric flasks - 10 ml
- 4.11 Vials (2 ml) and septum lined crimp caps
- 4.12 Porapak N - 80/100 mesh, Analabs Inc., North Haven, CT.
- 4.13 Column packings

- 4.13.1 Carbo-pack B, 60/80 mesh with 1% SP-1000 packed in an 8 ft x 0.1 in. I.D. stainless steel or glass column with helium carrier gas at 40 ml/min flow rate. Column temperature held at 45°C for 3 min., programmed at 8°C/min to 220°C held for 18 minutes - Halogen Specific
- 4.13.2 15% SF-96 and 6% OV-225 on Chromosorb WAW-DMCs, 6' x 1/4" O.D. glass column, argon/methane carrier gas at 30 ml/min., 60°C isothermal - Electron Capture

5. REAGENTS, SOLVENTS AND STANDARDS

- 5.1 Nitrogen or Helium - E.P.
- 5.2 Hydrogen - UHP
- 5.3 Methanol - nanograde
- 5.4 Sea sand
- 5.5 Standard

Obtain "neat" standards of compounds of interest from appropriate commercial vendors. Purity of each compound should be 95% or greater

5.6 Standard Stock Solutions

- 5.6.1 Prepare standard stock solutions every four weeks
- 5.6.2 Place about 9.8 ml of methyl alcohol into a ground glass stoppered 10 ml volumetric flask.
- 5.6.3 Allow the flask to stand unstoppered about 10 minutes or until all alcohol wetted surfaces have dried.
- 5.6.4 Weigh the flask to the nearest 0.1 mg.
- 5.6.5 Using a 100 µl syringe, immediately add 2 or 3 drops of the standard to the flask, then reweigh. Be sure that the drops fall directly into the alcohol without contacting the neck of the flask.

5.6.6 Dilute to volume, stopper, then mix by inverting the flask several times

5.6.7 Transfer the solution to a dated and labelled 15 ml screw cap bottle with a Teflon cap liner

NOTE: Because of the toxicity of many of the compounds, it is recommended that primary dilutions be prepared in a hood. It is further recommended that a NIOSH approved toxic gas respirator be used when the analyst handles high concentrations of such materials

5.6.8 Calculate the concentration from the net gain in weight. Calculate the concentration taking into account the percent purity of the original standard compound.

5.6.9 Store the solution at 4°C

5.7 Mixed Standard Solution

It is suggested that the individual stock solutions be diluted into a combined working solution in the range of 1-10 ng/μl, depending upon the detector used and the limit of detection desired.

6. CALIBRATION

The working solution prepared in 5.7 can be used to either prepare a calibration curve or to bracket the samples by either injecting varying volumes or by preparing additional concentrations of analytes.

7. QUALITY CONTROL

7.1 On each day that samples are purged a blank consisting of approximately 10 grams of sand and a spike (10 g sand plus compounds of interest at appropriate concentrations) are purged, trapped and eluted.

7.2 The methanol used for elution should be checked by GC using the same conditions as those for sample analyses.

7.3 Periodically a Porapak-N adsorption tube is eluted with methanol to check for contamination.

8. SAMPLE HANDLING AND PRESERVATION

Soil samples are collected in glass tubes which are sealed with septum closures and crimp caps immediately after sampling. Tubes should be iced or refrigerated at 4°C until analysis. Analysis should commence as soon as possible after collection.

9. PROCEDURE

9.1 Preparation of adsorption tubes - fill a 12'' section of 1/4'' glass tubing with Porapak-N and condition at 180°C for about 18-24 hours with nitrogen or helium flowing through the tube. The conditioned Porapak-N is used to prepare the adsorption tubes. The adsorption tubes are 6'' lengths of 1/4'' glass tubing filled with 1 to 1-1/4'' of packing material placed between two plugs of glass wool (see figure 1). Adsorption tubes should be washed with MeOH (30 ml) by slow suction and conditioned at 180°C for 30 minutes with gas flowing through them before and after each use. Tubes may be re-used until discoloration occurs or until recoveries decrease.

9.2 Purge, Trap, and Elution of Samples

9.2.1 Weigh the tube containing sample while still sealed with septum and cap. Record weight.

9.2.2 Place tube in a tube heater at 130°C. Immediately pierce the septum with two stainless steel needles connected to a recirculating pump with a Porapak-N adsorption tube in-line. This now constitutes a completely closed system. To help guard against water build-up of the Porapak-N, it is required that the system be fitted with a water trap such as a Tekmar, 5 ml sparge

chamber. (See figure 2)

9.2.3 Purge for 30 minutes

9.2.4 Remove the adsorption tube from the recirculating system and clamp in place over a 5 or 10 ml graduated tube. Add methanol and collect eluate to a volume of 1.5 ml, vial the eluate in a crimp cap vial.

9.2.5 The purged sample tubes are emptied and re-weighed with the corresponding septum and cap. The sample weight is obtained by difference (9.2.1-9.2.5)

9.3 Analyze the blank, spike, and sample eluates by gas chromatography (4.1.3). Compare chromatograms to those of standards for compound identification.

10. CALCULATIONS

Calculate the concentration of analyte in soil using the following formula:

$$\text{Concentration in Soil } \mu\text{g/g} = \frac{A}{B} \times \frac{C}{D} \times \frac{1.5}{E}$$

A = Area (or peak height) of sample

B = Area (or peak height) of standard

C = ng of standard

D = Volume sample injected

E = Weight of sample (grams)

Report results as $\mu\text{g/g}$, wet weight

11. REFERENCES

Narang, R.S., Bush, B., Determination of Arenes, Vinyl Chloride and
Other Volatile Halo-Organic Compounds in Water at Microgram per
Liter Levels by Gas Chromatography, Anal. Chem. 1980, 52, 2076-
2079.

Requested from Harin Lee 5/27/83

Narang, R.S., Manuscript in Preparation.

Implemented: April 1983

FIGURE 1.

ADSORPTION TUBE

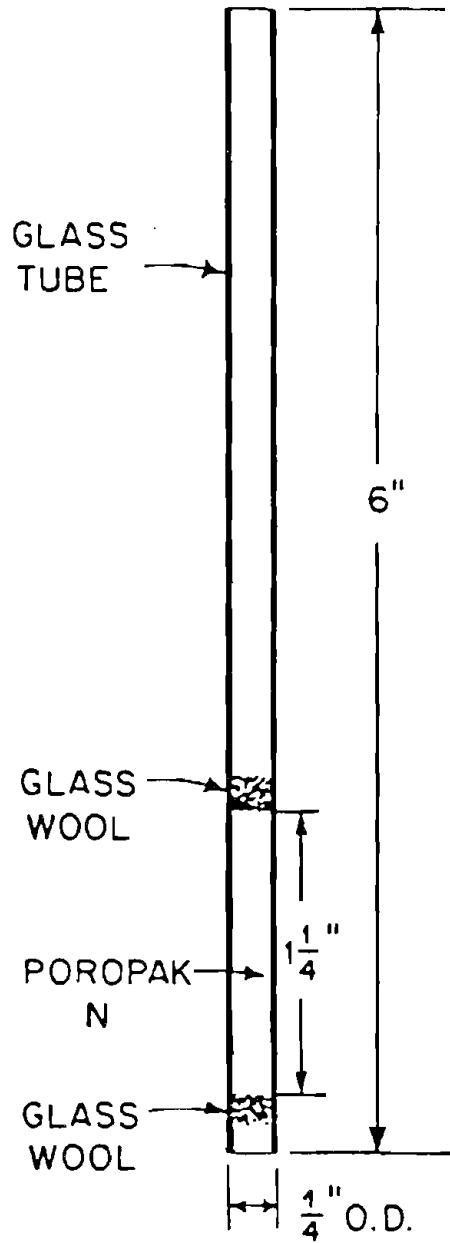

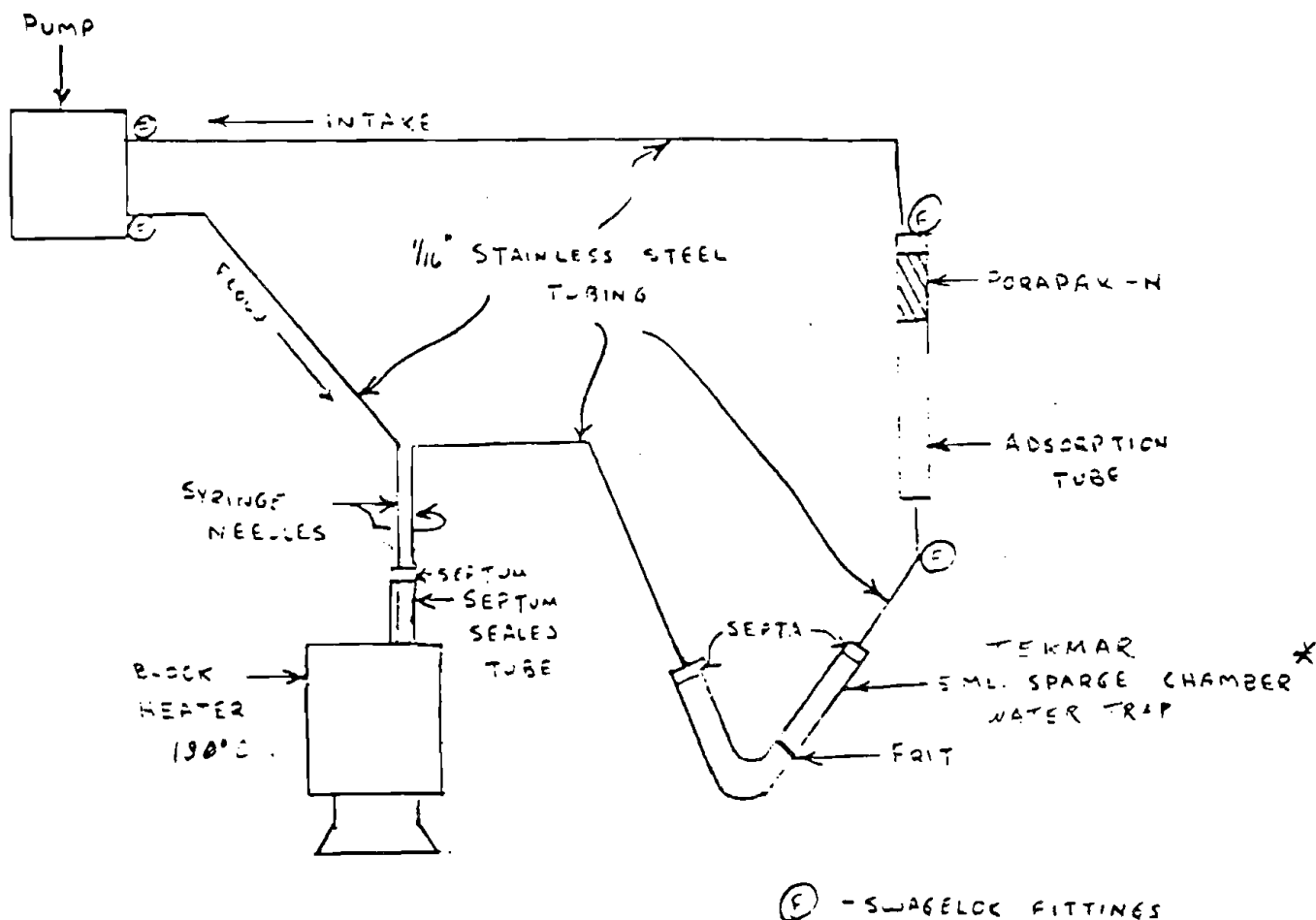
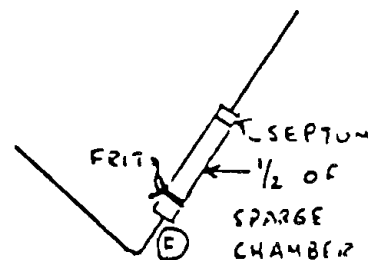
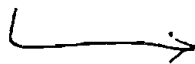

FIGURE 2
CLOSED LOOP STRIPPING

* ALTERNATE CONFIGURATION



L w 111



UNITED STATES ENVIRONMENTAL PROTECTION AGENCY

REGION II
26 FEDERAL PLAZA
NEW YORK, NEW YORK 10278

RECEIVED
OCT 3 1984
T. L. COLLINS

September 28, 1984

Mr. T.L. Collins, Manager
Environmental Quality and
Resource Planning
General Electric Company
Building 300-1, Nott St. Plant
Schenectady, New York 12345

Dear Mr. Collins:

We have reviewed your company's August 14, 1984 submittal regarding the soil sampling program to be conducted under the remedial investigation your company is performing pursuant to administrative order number II-CERCLA-30301. This program is substantially that discussed by Wayne Pierre of my staff with you, Wally Magee of your staff, Ray Cowen of the New York Department of Environmental Conservation and Sander Bonvell of Dunn Geoscience. We agree that Sections A, C, D and E represent a phase II sampling effort if in addition to the proposed work, samples are also collected at 75 feet and 100 feet along transects numbered 1 through 4 on the Lewis' driveway. This will encompass the area designated as "O" on the map enclosed with your August 14, 1984 submittal. This will also eliminate the need for sampling grid "O" as requested in your proposal.

Duplicate analyses on a minimum of 10 percent of the samples run with the McGraw-Edison PCB Test Kit should be performed and 10 percent of the samples should also be analyzed via a laboratory GC. This will assist in determining the reproducibility of the data using the test kit. We agree with the alternative location P' for P.

Therefore, with the modifications stated above, we approve the proposal for soil sampling at the GE Moreau site as presented in the August 14, 1984 letter.

Sincerely yours,

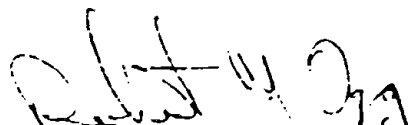
Robert W. Ogg, P.E., Chief
Site Investigation & Compliance
Branch

GENERAL ELECTRIC COMPANY
Schenectady, New York

Protocols for Sampling Domestic Wells at the Caputo Site, Town of Moreau, for Purgeable Organics; Sample Preservation; Chain of Custody; and Shipment.

This protocol follows the applicable procedures in sections 2.6.3, 9.9.1, 12.1.1, 12.5.1, 12.5.2, 12.6 and Chapters 15 and 16 in EPA 600/4-82-029, "Handbook for Sampling and Sample Preservation of Water and Wastewater" USEPA, September 1982.

1. Use only clean pre-numbered 40 ml vials, septa and caps.
2. Establish the sampling location at the closest faucet to the pump before the water receives any treatment. (If no pre-treatment tap is available, have one installed). Details of each system, to the extent possible, will be documented in the field notes.
3. Wipe the faucet lip with a clean rag and discard rag.
4. Let the water run to waste to clear the lines, pressure tank and sampling tap.
5. Collect two samples each in 40 ml vials after the flow has been reduced to minimize agitation and aeration. Fill the vials so that there is no head space after the cap is screwed down. The teflon septa should only be handled with clean disposable gloves.
6. Record the sample number on the sample log and on a 2 x 2 inch piece of paper with water-proof ink.
7. Place the bottles and the paper in a "ziplock" bag and then in an iced chest.
8. After all samples are collected fill out a laboratory chain of custody form and a lab instruction form. Lock the forms in the chest for delivery to a qualified laboratory, following chain of custody protocol.

General Electric
GE Moreau Off-Site Project
Proposed Soil Sampling Sites

The following proposed soil sampling locations were discussed at a site inspection on August 6, 1984. Present at this meeting were Wayne Pierre (USEPA), Ray Cowen (NYSDEC), Wally Magee and Leo Collins (GE) and Sander Bonvell (DGC).

Several of the locations were originally submitted to GE from EPA in an informal, handwritten format. References to these sites will be noted at the end of each section description.

Sections A, C, D and E represent EPA phase II sampling. The major road or path is transected down the middle. Every 50 feet in length a sample will be collected along the middle line and at points 25 and 50 feet perpendicular to this line and on each side of it. Exceptions are asphalted roads (section C) in which case no sample will be collected along the middle line.

Samples will be taken at a depth of approximately 6 inches below the "original" grade of 1960. In most cases that will also be the present grade. Where there is question concerning grade, split spoon samples will be taken to differentiate, if and where possible, different soil strata.

Soil samples will be collected with a small hand shovel or hand auger and washed between sites with detergent water.

Soil samples will be analyzed in the field or at the Dunn Geoscience Corporation laboratory by Dunn personnel using the McGraw-Edison PCB Test Kit supplied by General Electric. A minimum of 10% of the samples will be sent to a laboratory for confirmation by gas chromatography.

A minimum of two and a maximum of four field personnel will be involved in this program depending upon whether kit analysis is performed in the field or at the Dunn laboratory. Two people will stake the sites and sample the soils.

<u>Section</u>	<u>Description</u>
A	Lewis' driveway originating from Ft. Edward Road and extending to the house. Transected/Phase II; modification of original reference nos. 2-6.
B	Lewis' house. 50 foot grids parallel the sides of the house.
G	Present access road from Ft. Edward Road to Caputo site. Transected/Phase II.
D	Along the east fence of the Caputo site; originating from the northeast corner near the slurry ponds and extending to the gate adjacent to the NYSDEC trailer. Samples will be collected along or near the fence every 50 feet and then at 25 and 50 feet perpendicular to the fence in the eastward direction only.
E	Represents old access road connecting Lewis' driveway and the Caputo site near the northeast corner of the site at the bentonite storage area adjacent to the slurry ponds. Transected/Phase II.
F	From southwest corner of old barrel storage area extending to northeast corner of Caputo site fence. Variable sized grids between 25 and 100 feet on a side, dictated by vegetation.
C	Narrow, but worn, path extending from NMPC right of way. Samples collected every 50 feet along center line.
H	Old pathway extending from Lewis' driveway a short distance east of Lewis' house to the old access road. Samples collected every 50 ft. along the center line.
I	Pathways and open areas leading from/to Lewis' house. From an extension of the driveway just north of the house, extending to the west around the back of the house. Behind the house the path forks. One leg (western) leads through an open area to the northeast corner of the Caputo site fence. The other leg (eastern) leads around the south side of the house bisecting path H at a point approximately halfway between Lewis' house and old garage.
J	Along center line of NMPC right of way, southern leg, north of properties 36 and 39 on Moreau tax map. Composite samples taken every 50 feet for 400 feet extending southwest from the northeast corner of property 36. Reference original number 10.
K	Composite of following tax map locations: southwest corner of property 35; southeast corner of property 35; northeast corner of property 36; and a point at the general area of the southwest intersection of the two western legs of the NMPC right of way. Reference original number 7.

Section

- L Rectangular grid extending northeast from the southeast corner of property 35 along the NMPC right of way for 400 feet. Width is width of right of way. Reference original number 8.
- M Rectangular grid extending southwest of Fort Edward Road on NMPC right of way for 400 feet. Width is width of right of way. Reference original number 9.
- N Composite of soil sampled every 50 feet along a line parallel to the northwest boundary of property 35 and 50 ± 25 feet south of said boundary. Modification of original reference number 11.
- O Rectangular grid of tax map property 25. Reference original number 1.
- P Composite of the corners and center of a triangle formed by a point 50 ± 25 feet south of the northwest corner of property 35 (along its western boundary), extending 100 feet parallel to the northern boundary and 100 feet along the eastern boundary of property 13. Modification of original reference number 12.
- P' Composite of center and corners of triangle formed by a point 50-100 feet south of the northwest corner of property 35 and along its western boundary, extending 100 feet south along this western boundary and then 100 feet perpendicular to the east from this latter point.

Notes: Sites O and P are original EPA recommended grid locations. We suggest the elimination of sampling grid O due to the overlap of sampling sites from section A. We also suggest the replacement of triangular grid P with P' to bring sampling into an appropriately flat area of more importance.

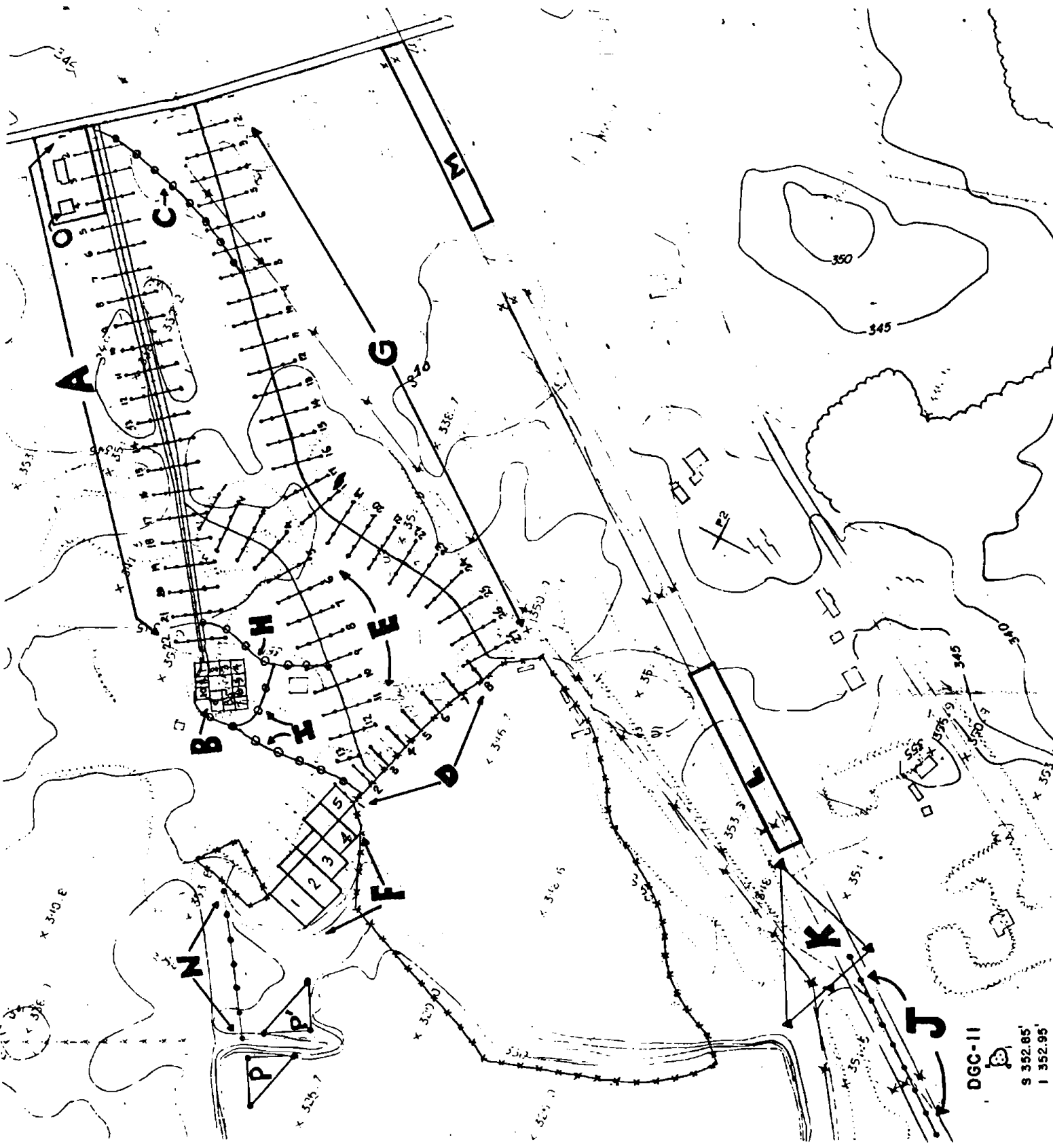

DGC-11
 9 352.85'
 1 352.95'

Dunn Geoscience Laboratory

5 Northway Lane North, Latham, NY 12110 (518) 783-8102

CLIENT: GENERAL ELECTRIC - NOTT ST.
 LAB NUMBER: 12821 DATE RECEIVED: 5/3/84
 TEST BY: JWH DATE TESTED: 5/3/84
 REVIEWED BY: *MB* DATE REPORTED: 5/8/84
 SAMPLE DESCR: WELL PACK SAND

GRAIN SIZE DISTRIBUTION

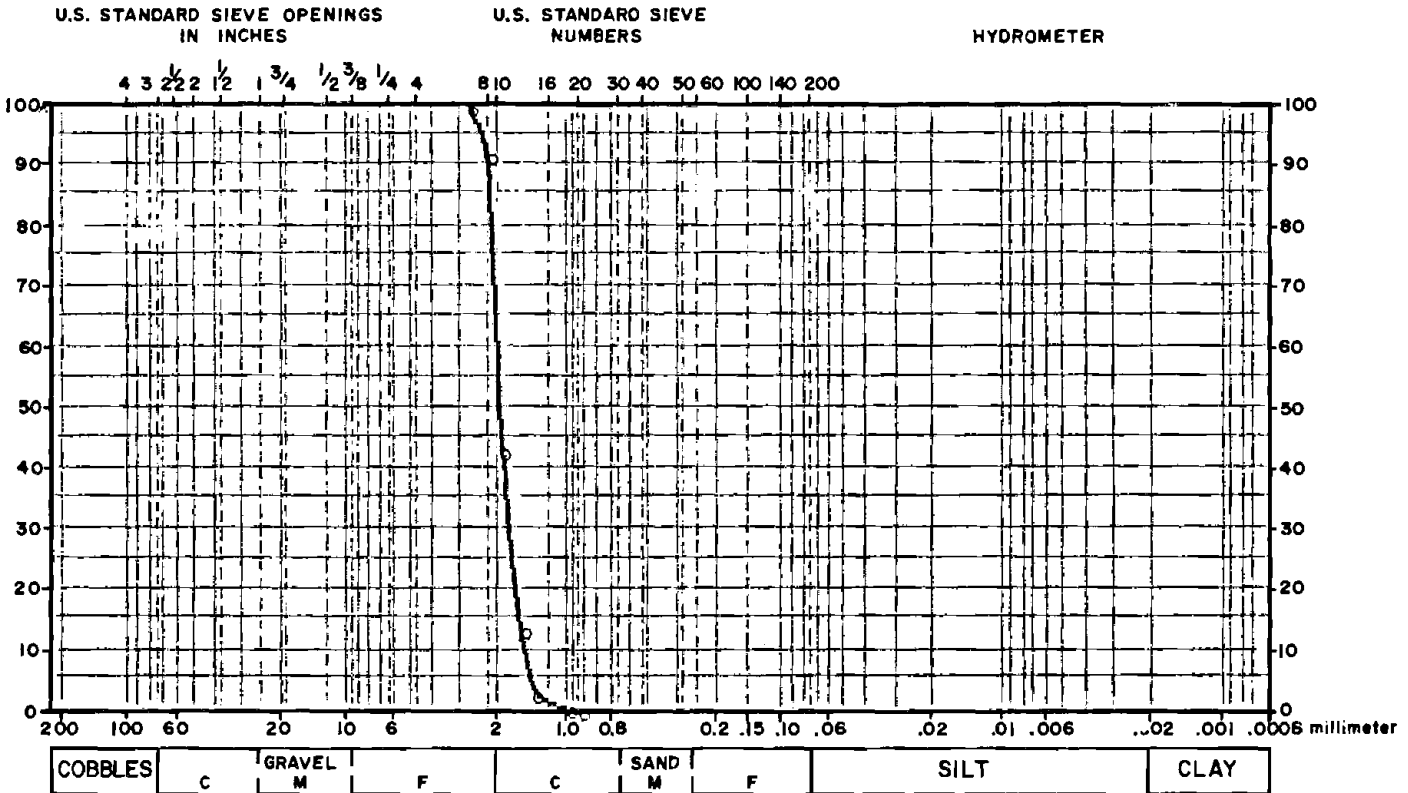

COARSE				FINE				HYDROMETER		
SIZE (inches)	PERCENT RETAINED	CUMULATIVE PERCENT PASSING	SPECS.	SIEVE	PERCENT RETAINED	CUMULATIVE PERCENT PASSING	SPECS.	PARTICLE DIAMETER (mm)	PERCENT PASSING	SPECS.
-	0.00	0.00	-	8	0.07	99.93	-			
-	0.00	0.00	-	10	7.60	92.33	-			
-	0.00	0.00	-	12	49.06	43.26	-			
-	0.00	0.00	-	14	29.02	14.25	-			
-	0.00	0.00	-	16	10.89	3.36	-			
-	0.00	0.00	-	20	3.00	.36	-			
-	0.00	0.00	-	25	.20	.16	-			
-	0.00	0.00	-	-	0.00	0.00	-			
-	0.00	0.00	-	-	0.00	0.00	-			
-	0.00	0.00	-	-	0.00	0.00	-			
-	0.00	0.00	-	-	0.00	0.00	-			
-	0.00	0.00	-	-	0.00	0.00	-			

FAN = .2%
 WASH LOSS WAS NOT TESTED.

SPECIFICATION: ASTM C 136

TEST STANDARD: NA

NOTES: NONE

Dunn Geoscience Laboratory

5 Northway Lane North, Latham, NY 12110 (518) 783-8102

CLIENT: GENERAL ELECTRIC COMPANY NOTT STREET
 LAB NUMBER: 12903 DATE RECEIVED: 7/5/84
 TEST BY: JWH DATE TESTED: 7/17/84
 REVIEWED BY: *MJZ* DATE REPORTED: 7/24/84
 SAMPLE DESCR: BORING DGC-1 S-16 30.0' - 32.0'

GRAIN SIZE DISTRIBUTION

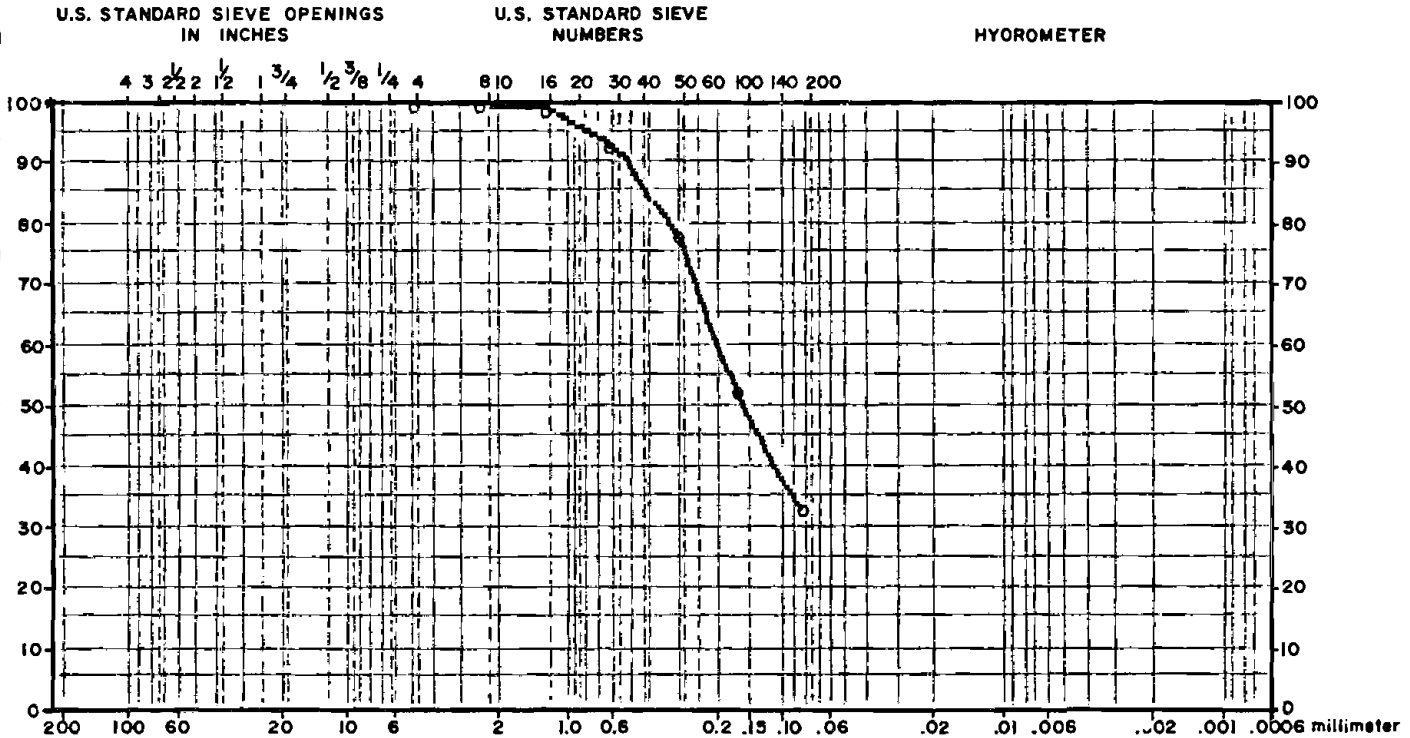

COBBLES	GRAVEL	SAND	SILT	CLAY
C	M	F		

COARSE				FINE				HYDROMETER		
SIZE (inches)	PERCENT RETAINED	CUMULATIVE PERCENT PASSING	SPECS.	SIEVE	PERCENT RETAINED	CUMULATIVE PERCENT PASSING	SPECS.	PARTICLE DIAMETER (mm)	PERCENT PASSING	SPECS.
-	0.00	0.00	-	4	0.00	100.00	-			
-	0.00	0.00	-	8	.13	99.87	-			
-	0.00	0.00	-	16	.83	99.04	-			
-	0.00	0.00	-	30	5.58	93.45	-			
-	0.00	0.00	-	50	15.08	78.37	-			
-	0.00	0.00	-	100	25.35	53.02	-			
-	0.00	0.00	-	200	19.90	33.12	-			
-	0.00	0.00	-	-	0.00	0.00	-			
-	0.00	0.00	-	-	0.00	0.00	-			
-	0.00	0.00	-	-	0.00	0.00	-			
-	0.00	0.00	-	-	0.00	0.00	-			
-	0.00	0.00	-	-	0.00	0.00	-			

PAN = 33.1%
 WASH LOSS = 29.7%

SPECIFICATION: ASTM C-136 ASTM C-117

TEST STANDARD: NONE

NOTES: NONE

Test samples are retained for 30 days after submission and then discarded, unless other arrangements are made.

Dunn Geoscience Laboratory

5 Northway Lane North, Latham, NY 12110 (518) 783-8102

CLIENT:	GENERAL ELECTRIC COMPANY	NOTT STREET
LAB NUMBER:	12904	DATE RECEIVED: 7/5/84
TEST BY:	JWH	DATE TESTED: 7/9/84
REVIEWED BY:	<i>mgz</i>	DATE REPORTED: 7/10/84
SAMPLE DESCR:	BORING DGC 1 S-34 66'-68'	

GRAIN SIZE DISTRIBUTION

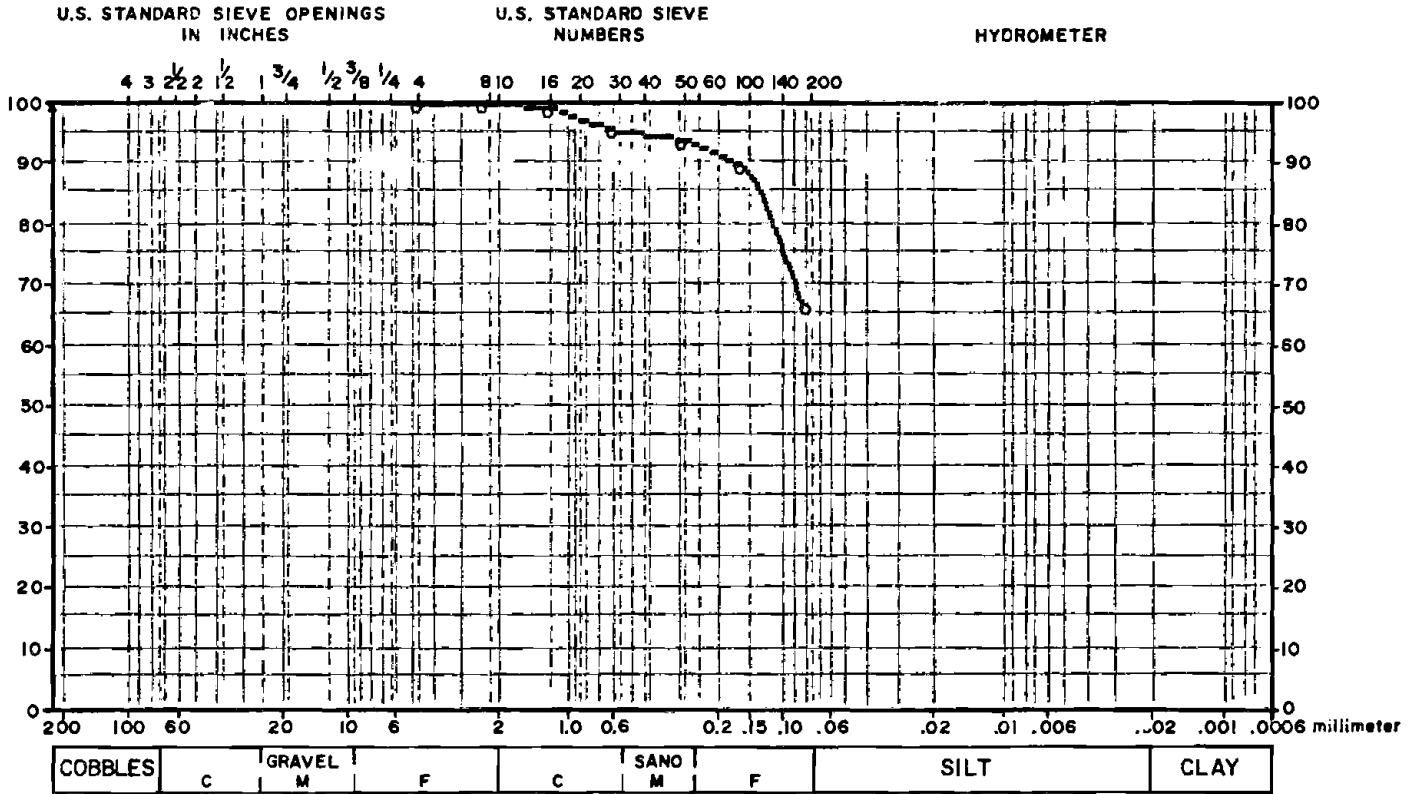

COARSE				FINE				HYDROMETER		
SIZE (Inches)	PERCENT RETAINED	CUMULATIVE PERCENT PASSING	SPECS.	SIEVE	PERCENT RETAINED	CUMULATIVE PERCENT PASSING	SPECS.	PARTICLE DIAMETER (mm)	PERCENT PASSING	SPECS.
-	0.00	0.00	-	4	0.00	100.00	-			
-	0.00	0.00	-	8	0.00	100.00	-			
-	0.00	0.00	-	16	.42	99.58	-			
-	0.00	0.00	-	30	3.61	95.97	-			
-	0.00	0.00	-	50	1.84	94.13	-			
-	0.00	0.00	-	100	3.82	90.30	-			
-	0.00	0.00	-	200	23.92	66.38	-			
-	0.00	0.00	-	-	0.00	0.00	-			
-	0.00	0.00	-	-	0.00	0.00	-			
-	0.00	0.00	-	-	0.00	0.00	-			
-	0.00	0.00	-	-	0.00	0.00	-			
-	0.00	0.00	-	-	0.00	0.00	-			

PAN = 66.4%
WASH LOSS WAS NOT TESTED.

SPECIFICATION: ASTM C-136
TEST STANDARD: NONE
NOTES: NONE

Dunn Geoscience Laboratory

5 Northway Lane North, Latham, NY 12110 (518) 783-8102

CLIENT:	GENERAL ELECTRIC COMPANY	NOTT STREET
LAB NUMBER:	12905	DATE RECEIVED: 7/5/84
TEST BY:	JWH	DATE TESTED: 7/9/84
REVIEWED BY:	<i>mqz</i>	DATE REPORTED: 7/10/84
SAMPLE DESCR:	BOREING DGC 11 S-2	47.0' - 49.0'

GRAIN SIZE DISTRIBUTION

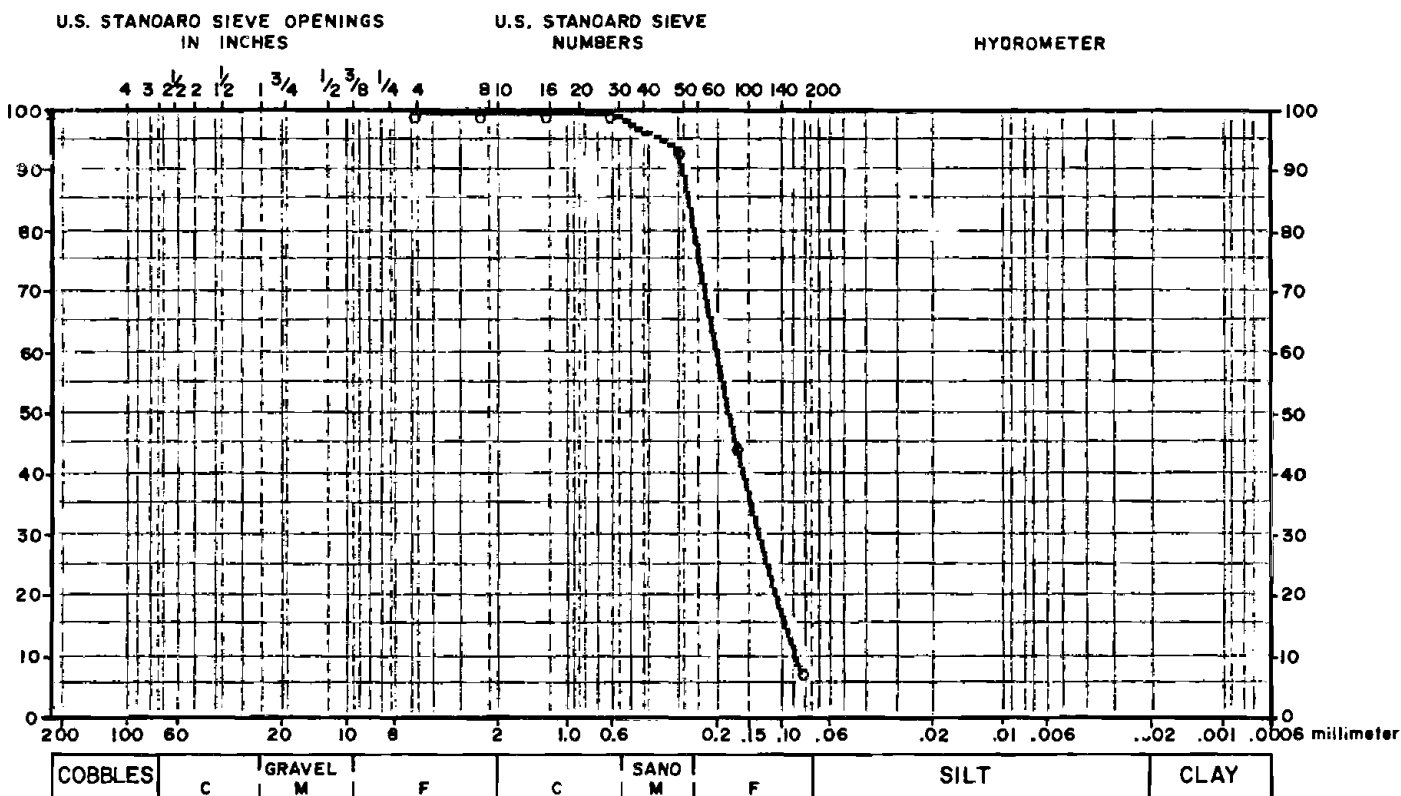

COARSE			
SIZE (inches)	PERCENT RETAINED	CUMULATIVE PERCENT PASSING	SPECS.
-	0.00	0.00	-
-	0.00	0.00	-
-	0.00	0.00	-
-	0.00	0.00	-
-	0.00	0.00	-
-	0.00	0.00	-
-	0.00	0.00	-
-	0.00	0.00	-
-	0.00	0.00	-
-	0.00	0.00	-
-	0.00	0.00	-
-	0.00	0.00	-
-	0.00	0.00	-

FINE			
SIEVE	PERCENT RETAINED	CUMULATIVE PERCENT PASSING	SPECS.
4	0.00	100.00	-
8	0.00	100.00	-
16	.04	99.96	-
30	.08	99.88	-
50	5.59	94.29	-
100	48.90	45.39	-
200	37.24	8.15	-
-	0.00	0.00	-
-	0.00	0.00	-
-	0.00	0.00	-
-	0.00	0.00	-
-	0.00	0.00	-

HYDROMETER		
PARTICLE DIAMETER (mm)	PERCENT PASSING	SPECS.
-	-	-

PAN = 8.1%
WASH LOSS WAS NOT TESTED.

SPECIFICATION: ASTM C-136

TEST STANDARD: NONE

NOTES: NONE

Dunn Geoscience Laboratory

5 Northway Lane North, Latham, NY 12110 (518) 783-8102

CLIENT:	GENERAL ELECTRIC COMPANY	NOTT STREET
LAB NUMBER:	12906	DATE RECEIVED: 7/5/84
TEST BY:	JWH	DATE TESTED: 7/9/84
REVIEWED BY:	<i>mgz</i>	DATE REPORTED: 7/10/84
SAMPLE DESCR:	BORING DGC 1S S-1 26' - 28'	

GRAIN SIZE DISTRIBUTION

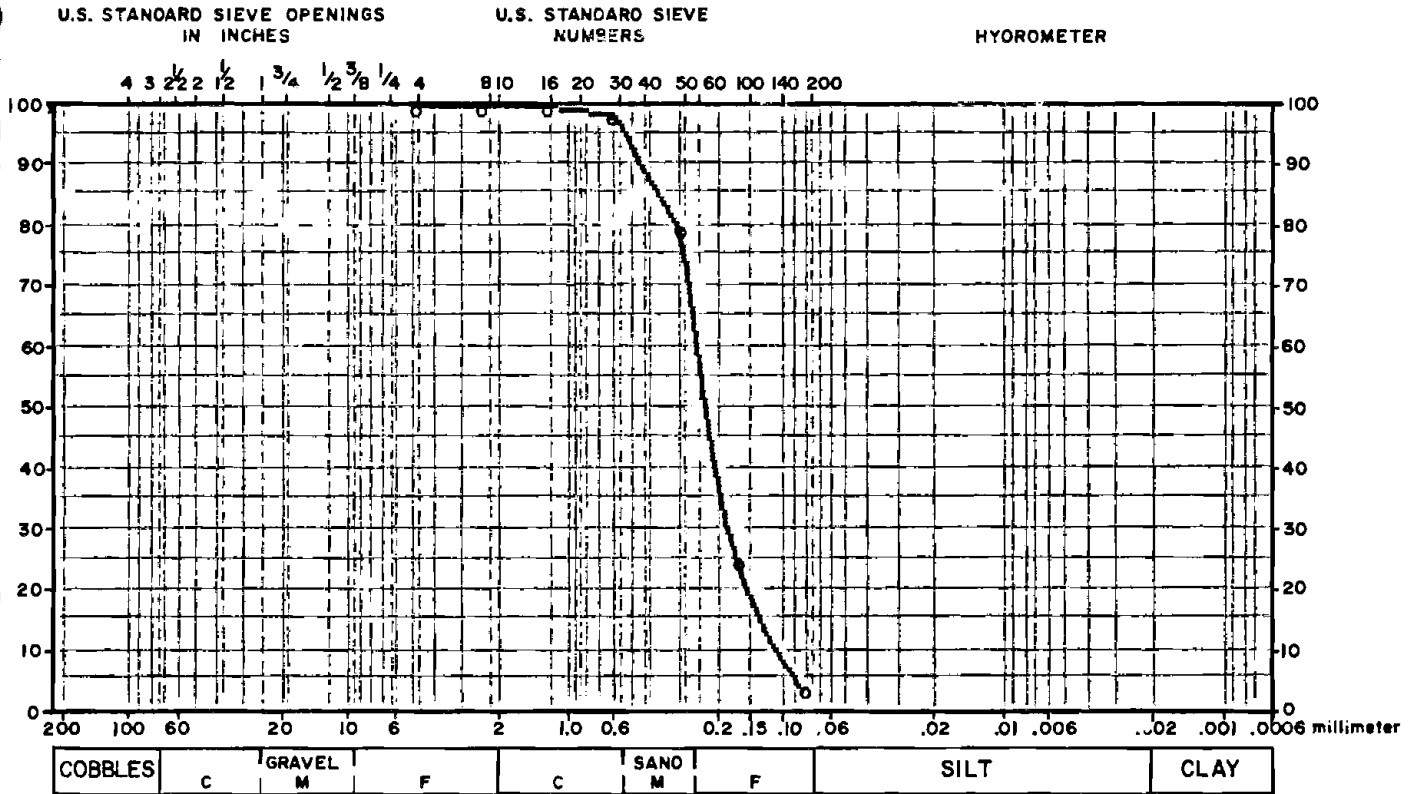

COARSE				FINE				HYDROMETER		
SIZE (inches)	PERCENT RETAINED	CUMULATIVE PERCENT PASSING	SPECS.	SIEVE	PERCENT RETAINED	CUMULATIVE PERCENT PASSING	SPECS.	PARTICLE DIAMETER (mm)	PERCENT PASSING	SPECS.
-	0.00	0.00	-	4	0.00	100.00	-			
-	0.00	0.00	-	8	0.00	100.00	-			
-	0.00	0.00	-	16	.14	99.86	-			
-	0.00	0.00	-	30	1.14	98.72	-			
-	0.00	0.00	-	50	18.56	80.16	-			
-	0.00	0.00	-	100	54.92	25.24	-			
-	0.00	0.00	-	200	21.17	4.07	-			
-	0.00	0.00	-	-	0.00	0.00	-			
-	0.00	0.00	-	-	0.00	0.00	-			
-	0.00	0.00	-	-	0.00	0.00	-			
-	0.00	0.00	-	-	0.00	0.00	-			
-	0.00	0.00	-	-	0.00	0.00	-			
-	0.00	0.00	-	-	0.00	0.00	-			

PAN = 4.1%
WASH LOSS WAS NOT TESTED.

SPECIFICATION: ASTM C-136
TEST STANDARD: NONE
NOTES: NONE

Dunn Geoscience Laboratory

5 Northway Lane North, Latham, NY 12110 (518) 783-8102

CLIENT: GENERAL ELECTRIC COMPANY NOTT STREET
 LAB NUMBER: 12907 DATE RECEIVED: 7/5/84
 TEST BY: JWH DATE TESTED: 7/9/84
 REVIEWED BY: *MJZ* DATE REPORTED: 7/10/84
 SAMPLE DESCR: BORING DGC 2 S-32 62.0' - 64.0'

GRAIN SIZE DISTRIBUTION

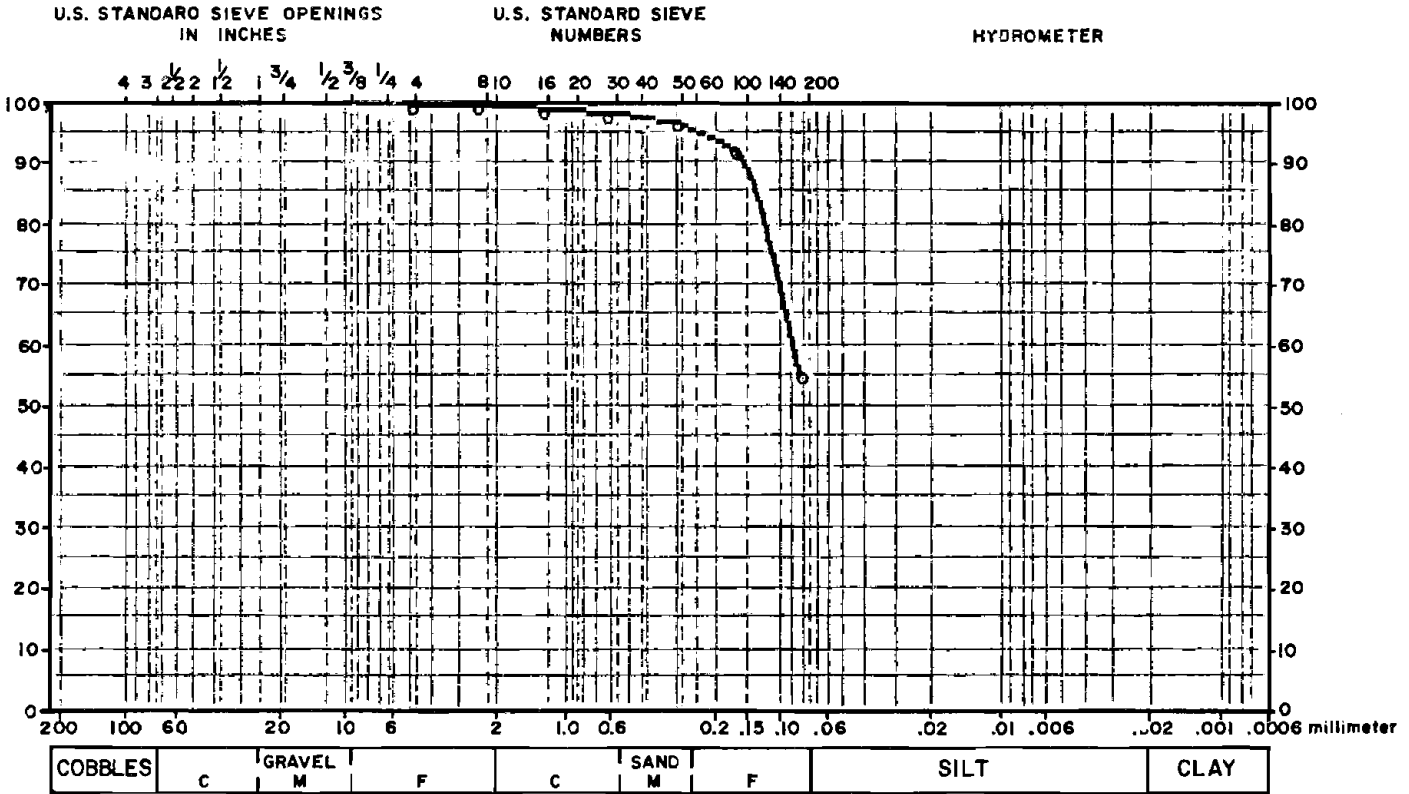

COARSE				FINE				HYDROMETER		
SIZE (inches)	PERCENT RETAINED	CUMULATIVE PERCENT PASSING	SPECS.	SIEVE	PERCENT RETAINED	CUMULATIVE PERCENT PASSING	SPECS.	PARTICLE DIAMETER (mm)	PERCENT PASSING	SPECS.
-	0.00	0.00	-	4	0.00	100.00	-	-	-	-
-	0.00	0.00	-	8	0.00	100.00	-	-	-	-
-	0.00	0.00	-	16	.42	99.58	-	-	-	-
-	0.00	0.00	-	30	.85	98.73	-	-	-	-
-	0.00	0.00	-	50	1.59	97.14	-	-	-	-
-	0.00	0.00	-	100	4.18	92.96	-	-	-	-
-	0.00	0.00	-	200	37.94	55.03	-	-	-	-
-	0.00	0.00	-	-	0.00	0.00	-	-	-	-
-	0.00	0.00	-	-	0.00	0.00	-	-	-	-
-	0.00	0.00	-	-	0.00	0.00	-	-	-	-
-	0.00	0.00	-	-	0.00	0.00	-	-	-	-
-	0.00	0.00	-	-	0.00	0.00	-	-	-	-

PAN = 55.0%
 WASH LOSS WAS NOT TESTED.

SPECIFICATION: ASTM C-136
 TEST STANDARD: NONE
 NOTES: NONE

Dunn Geoscience Laboratory

5 Northway Lane North, Latham, NY 12110 (518) 783-8102

CLIENT: GENERAL ELECTRIC COMPANY NOTT STREET
 LAB NUMBER: 12908 DATE RECEIVED: 7/5/84
 TEST BY: JWH DATE TESTED: 7/18/84
 REVIEWED BY: *MJS* DATE REPORTED: 7/25/84
 SAMPLE DESCR: BORING DGC-2 S-38 74.0' - 76.0'

GRAIN SIZE DISTRIBUTION

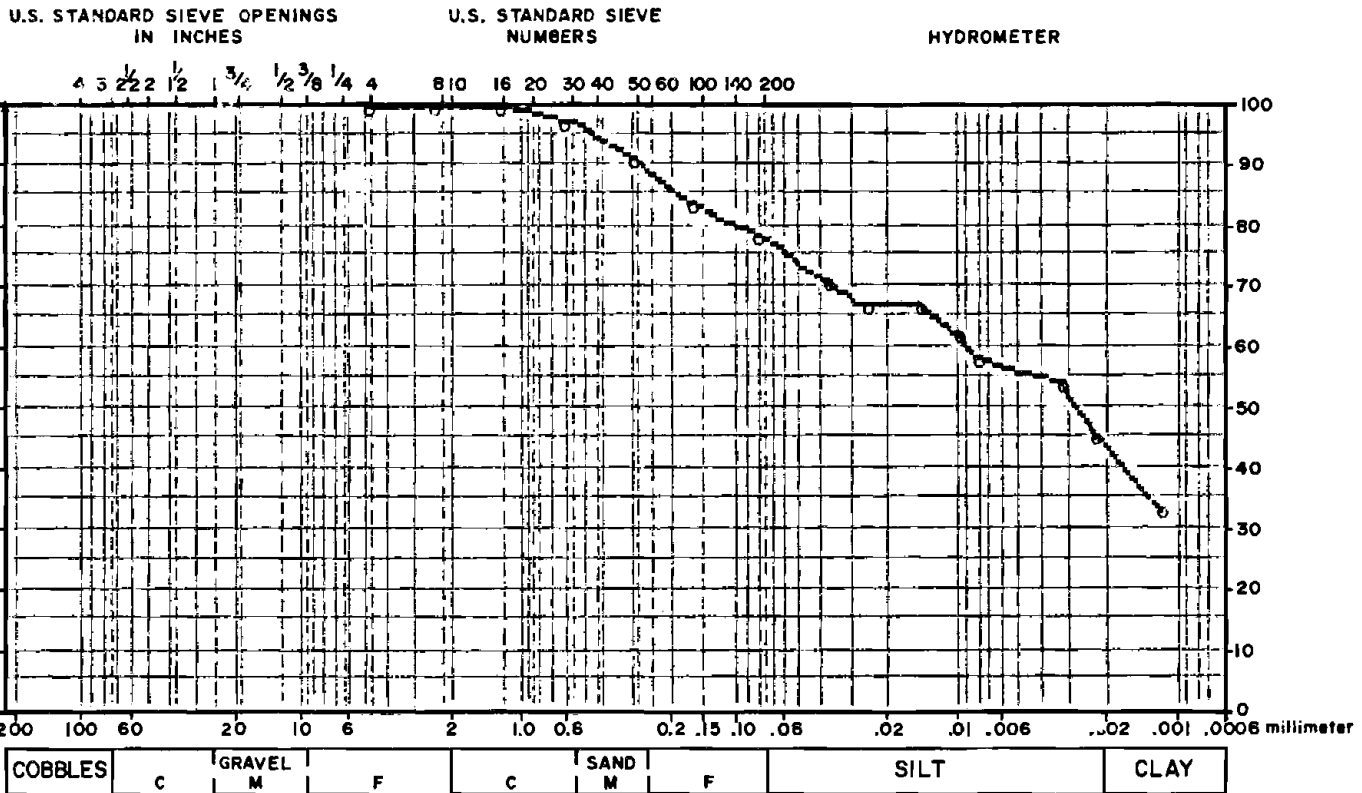

COARSE				FINE				HYDROMETER		
SIZE (inches)	PERCENT RETAINED	CUMULATIVE PERCENT PASSING	SPECS.	SIEVE	PERCENT RETAINED	CUMULATIVE PERCENT PASSING	SPECS.	PARTICLE DIAMETER (mm)	PERCENT PASSING	SPECS.
-	0.00	0.00	-	4	0.00	100.00	-	.036	71.36	-
-	0.00	0.00	-	8	0.00	100.00	-	.023	67.16	-
-	0.00	0.00	-	16	0.00	100.00	-	.013	67.16	-
-	0.00	0.00	-	30	2.40	97.60	-	.009	62.97	-
-	0.00	0.00	-	50	6.01	91.58	-	.007	58.77	-
-	0.00	0.00	-	100	7.62	83.97	-	.003	54.57	-
-	0.00	0.00	-	200	5.01	78.96	-	.002	46.18	-
-	0.00	0.00	-	-	0.00	0.00	-	.001	33.58	-

PAN = 79.0%
 WASH LOSS WAS NOT TESTED.

SPECIFICATION: ASTM C-136 ASTM D-422

TEST STANDARD: NONE

NOTES: NONE

Test samples are retained for 30 days after submission and then discarded, unless other arrangements are made.

Dunn Geoscience Laboratory

5 Northway Lane North, Latham, NY 12110 (518) 783-8102

CLIENT:	GENERAL ELECTRIC COMPANY	NOTT STREET
LAB NUMBER:	12909	DATE RECEIVED: 7/5/84
TEST BY:	JWH	DATE TESTED: 7/9/84
REVIEWED BY:	<i>MJZ</i>	DATE REPORTED: 7/10/84
SAMPLE DESCR:	BORING DGC 21 S-2 43.0' - 45.0'	

GRAIN SIZE DISTRIBUTION

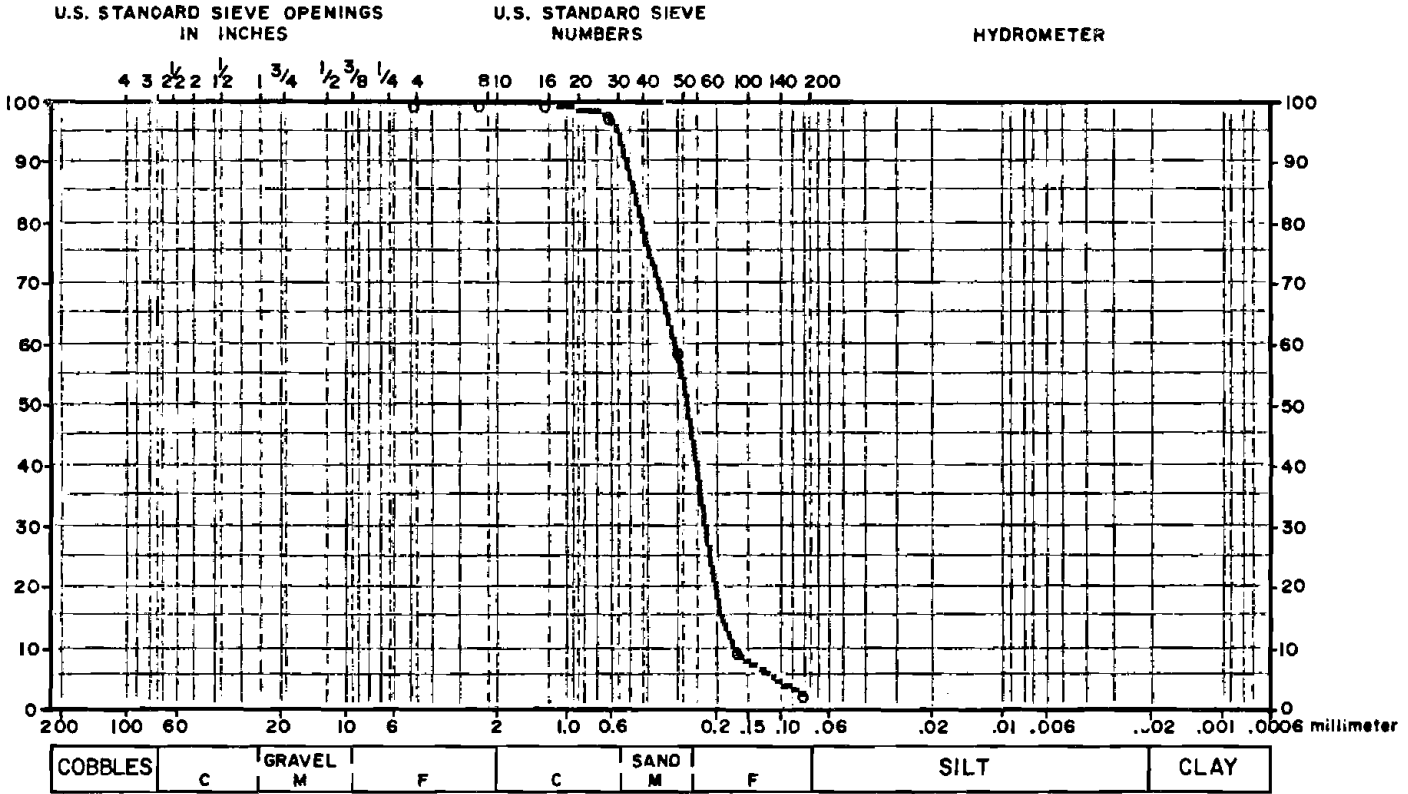

COARSE				FINE				HYDROMETER		
SIZE (inches)	PERCENT RETAINED	CUMULATIVE PERCENT PASSING	SPECS.	SIEVE	PERCENT RETAINED	CUMULATIVE PERCENT PASSING	SPECS.	PARTICLE DIAMETER (mm)	PERCENT PASSING	SPECS.
-	0.00	0.00	-	4	0.00	100.00	-	-	-	-
-	0.00	0.00	-	8	0.00	100.00	-	-	-	-
-	0.00	0.00	-	16	.05	99.95	-	-	-	-
-	0.00	0.00	-	30	1.87	98.08	-	-	-	-
-	0.00	0.00	-	50	38.47	59.62	-	-	-	-
-	0.00	0.00	-	100	49.42	10.20	-	-	-	-
-	0.00	0.00	-	200	7.30	2.90	-	-	-	-
-	0.00	0.00	-	-	0.00	0.00	-	-	-	-
-	0.00	0.00	-	-	0.00	0.00	-	-	-	-
-	0.00	0.00	-	-	0.00	0.00	-	-	-	-
-	0.00	0.00	-	-	0.00	0.00	-	-	-	-
-	0.00	0.00	-	-	0.00	0.00	-	-	-	-

PAN = 2.9%
WASH LOSS WAS NOT TESTED.

SPECIFICATION: ASTM C-136

TEST STANDARD: NONE

NOTES: NONE

Dunn Geoscience Laboratory

5 Northway Lane North, Latham, NY 12110 (518) 783-8102

CLIENT: GENERAL ELECTRIC COMPANY NOTT STREET
 LAB NUMBER: 12910 DATE RECEIVED: 7/5/84
 TEST BY: JWH DATE TESTED: 7/9/84
 REVIEWED BY: *MJZ* DATE REPORTED: 7/10/84
 SAMPLE DESCR: *BOBING* DGC 2S S-1 24.0' - 26.0'

GRAIN SIZE DISTRIBUTION

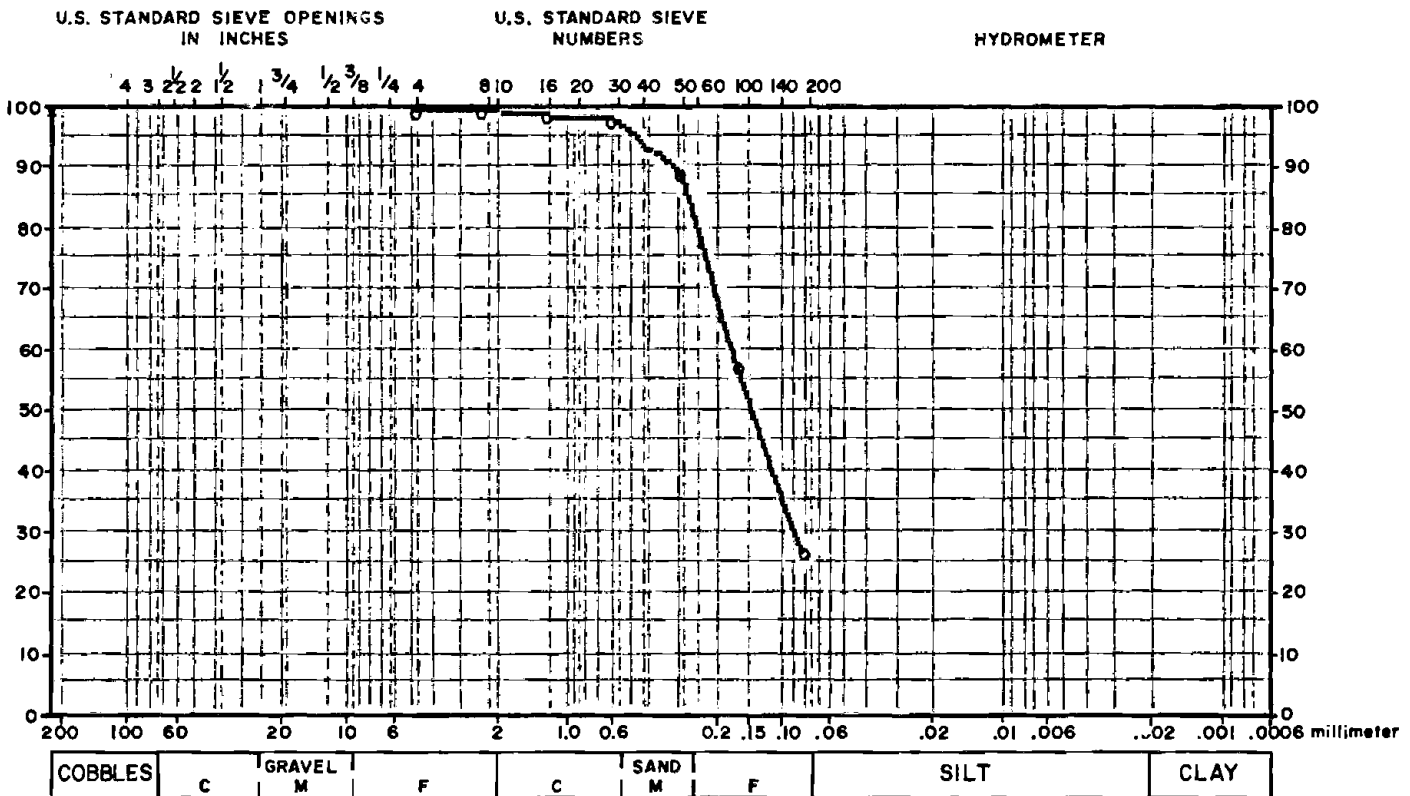

COARSE				FINE				HYDROMETER		
SIZE (inches)	PERCENT RETAINED	CUMULATIVE PERCENT PASSING	SPECS.	SIEVE	PERCENT RETAINED	CUMULATIVE PERCENT PASSING	SPECS.	PARTICLE DIAMETER (mm)	PERCENT PASSING	SPECS.
-	0.00	0.00	-	4	0.00	100.00	-			
-	0.00	0.00	-	8	0.00	100.00	-			
-	0.00	0.00	-	16	1.00	99.00	-			
-	0.00	0.00	-	30	.60	98.41	-			
-	0.00	0.00	-	50	8.12	90.28	-			
-	0.00	0.00	-	100	32.19	58.10	-			
-	0.00	0.00	-	200	30.54	27.55	-			
-	0.00	0.00	-	-	0.00	0.00	-			
-	0.00	0.00	-	-	0.00	0.00	-			
-	0.00	0.00	-	-	0.00	0.00	-			
-	0.00	0.00	-	-	0.00	0.00	-			
-	0.00	0.00	-	-	0.00	0.00	-			

PAN = 27.6%
 WASH LOSS WAS NOT TESTED.

SPECIFICATION: ASTM C-136
 TEST STANDARD: NONE
 NOTES: NONE

Dunn Geoscience Laboratory

5 Northway Lane North, Latham, NY 12110 (518) 783-8102

CLIENT:	GENERAL ELECTRIC COMPANY	NOTT STREET
LAB NUMBER:	12911	DATE RECEIVED: 7/5/84
TEST BY:	JWH	DATE TESTED: 7/17/84
REVIEWED BY:	<i>MJ 3</i>	DATE REPORTED: 7/24/84
SAMPLE DESCR:	BORING DGC-3 S-12	55.0' - 57.0'

GRAIN SIZE DISTRIBUTION

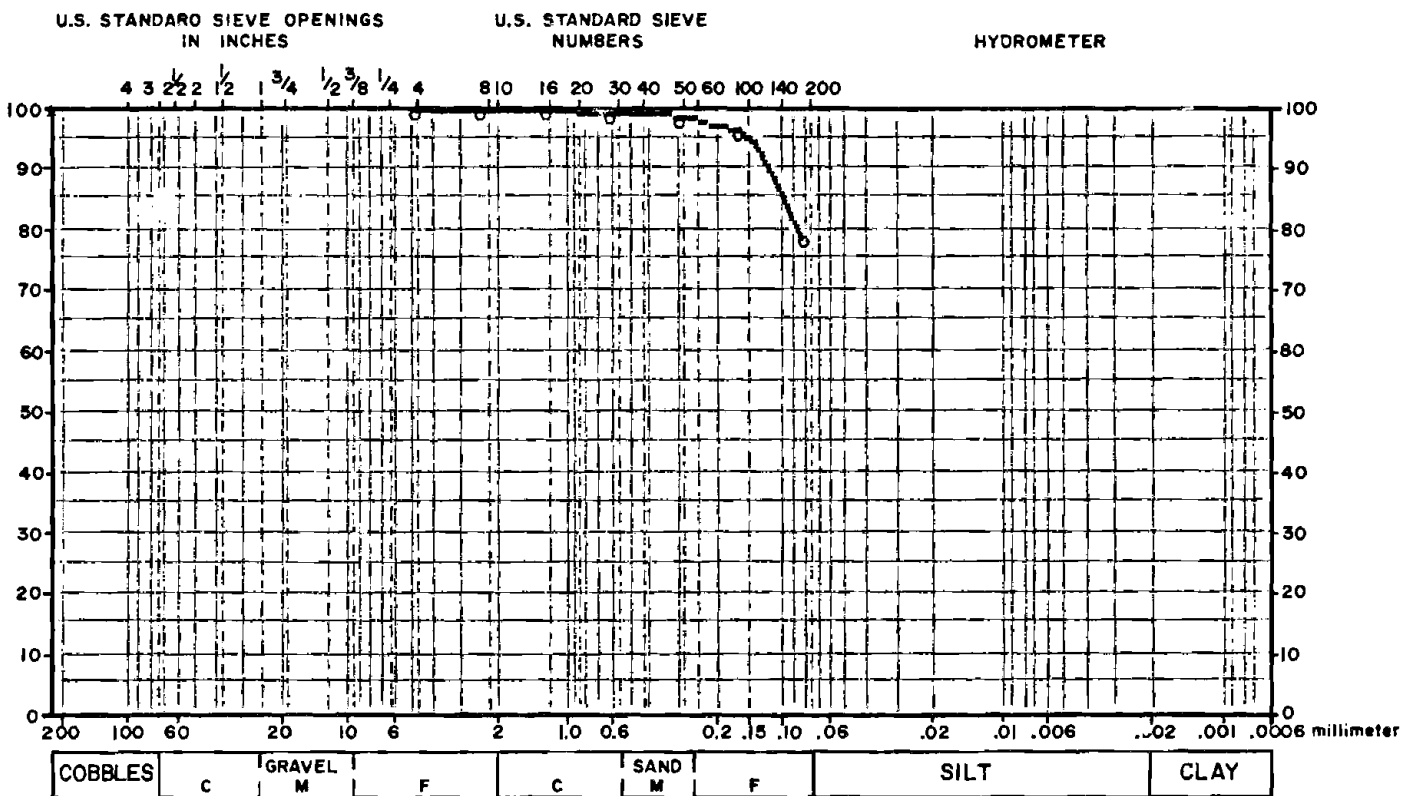

COBBLES	C	GRAVEL	M	F	C	SAND	M	F	SILT	CLAY
---------	---	--------	---	---	---	------	---	---	------	------

COARSE			
SIZE (inches)	PERCENT RETAINED	CUMULATIVE PERCENT PASSING	SPECS.

FINE			
SIEVE	PERCENT RETAINED	CUMULATIVE PERCENT PASSING	SPECS.

HYDROMETER		
PARTICLE DIAMETER (mm)	PERCENT PASSING	SPECS.

-	0.00	0.00	-	4	0.00	100.00	-
-	0.00	0.00	-	8	0.00	100.00	-
-	0.00	0.00	-	16	.21	99.79	-
-	0.00	0.00	-	30	.21	99.57	-
-	0.00	0.00	-	50	.64	98.93	-
-	0.00	0.00	-	100	2.14	96.78	-
-	0.00	0.00	-	200	18.01	78.78	-
-	0.00	0.00	-	-	0.00	0.00	-
-	0.00	0.00	-	-	0.00	0.00	-
-	0.00	0.00	-	-	0.00	0.00	-
-	0.00	0.00	-	-	0.00	0.00	-
-	0.00	0.00	-	-	0.00	0.00	-

PAN = 78.8%
WASH LOSS = 57.6%

SPECIFICATION: ASTM C-136 ASTM C-117

TEST STANDARD: NONE

NOTES: NONE

Test samples are retained for 30 days after submission

Dunn Geoscience Laboratory

5 Northway Lane North, Latham, NY 12110 (518) 783-8102

CLIENT: GENERAL ELECTRIC COMPANY NOTT STREET
 LAB NUMBER: 12912 DATE RECEIVED: 7/5/84
 TEST BY: JWH DATE TESTED: 7/17/84
 REVIEWED BY: *MJ* DATE REPORTED: 7/24/84
 SAMPLE DESCR: BORING DGC-3 S-14 60.0' - 62.0'

GRAIN SIZE DISTRIBUTION

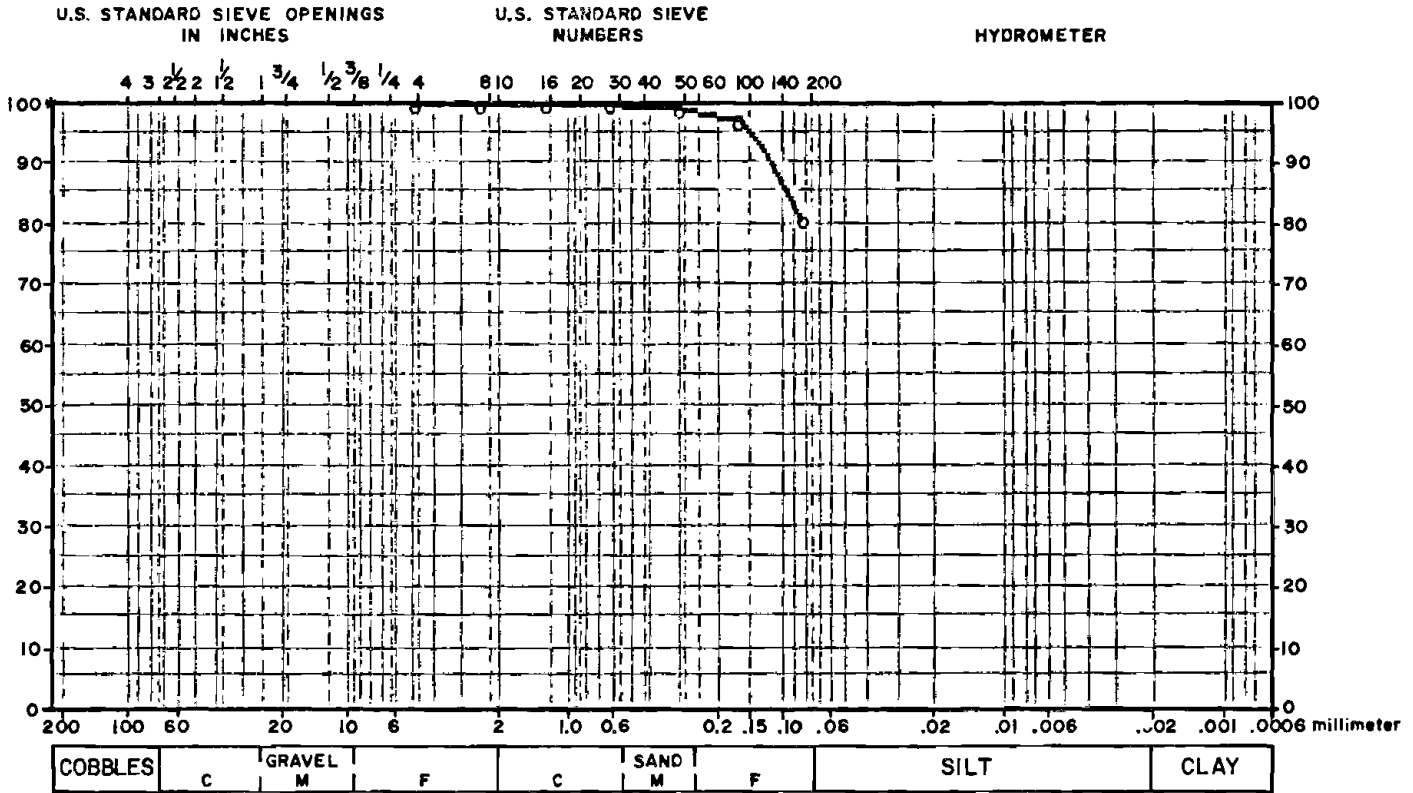

COARSE				FINE				HYDROMETER		
SIZE (inches)	PERCENT RETAINED	CUMULATIVE PERCENT PASSING	SPECS.	SIEVE	PERCENT RETAINED	CUMULATIVE PERCENT PASSING	SPECS.	PARTICLE DIAMETER (mm)	PERCENT PASSING	SPECS.

-	0.00	0.00	-	4	0.00	100.00	-			
-	0.00	0.00	-	8	0.00	100.00	-			
-	0.00	0.00	-	16	0.00	100.00	-			
-	0.00	0.00	-	30	.27	99.73	-			
-	0.00	0.00	-	50	.69	99.04	-			
-	0.00	0.00	-	100	2.03	97.01	-			
-	0.00	0.00	-	200	16.47	80.54	-			
-	0.00	0.00	-	-	0.00	0.00	-			
-	0.00	0.00	-	-	0.00	0.00	-			
-	0.00	0.00	-	-	0.00	0.00	-			
-	0.00	0.00	-	-	0.00	0.00	-			
-	0.00	0.00	-	-	0.00	0.00	-			

PAN = 80.5%
 WASH LOSS = 69.3%

SPECIFICATION: ASTM C-136 ASTM C-117
 TEST STANDARD: NONE
 NOTES: NONE

Dunn Geoscience Laboratory

5 Northway Lane North, Latham, NY 12110 (518) 783-8102

CLIENT: GENERAL ELECTRIC COMPANY NOTT STREET
 LAB NUMBER: 12913 DATE RECEIVED: 7/5/84
 TEST BY: JWH DATE TESTED: 7/10/84
 REVIEWED BY: *MJZ* DATE REPORTED: 7/10/84
 SAMPLE DESCR: BORING DGC-3I S-2 42.0' - 44.0'

GRAIN SIZE DISTRIBUTION

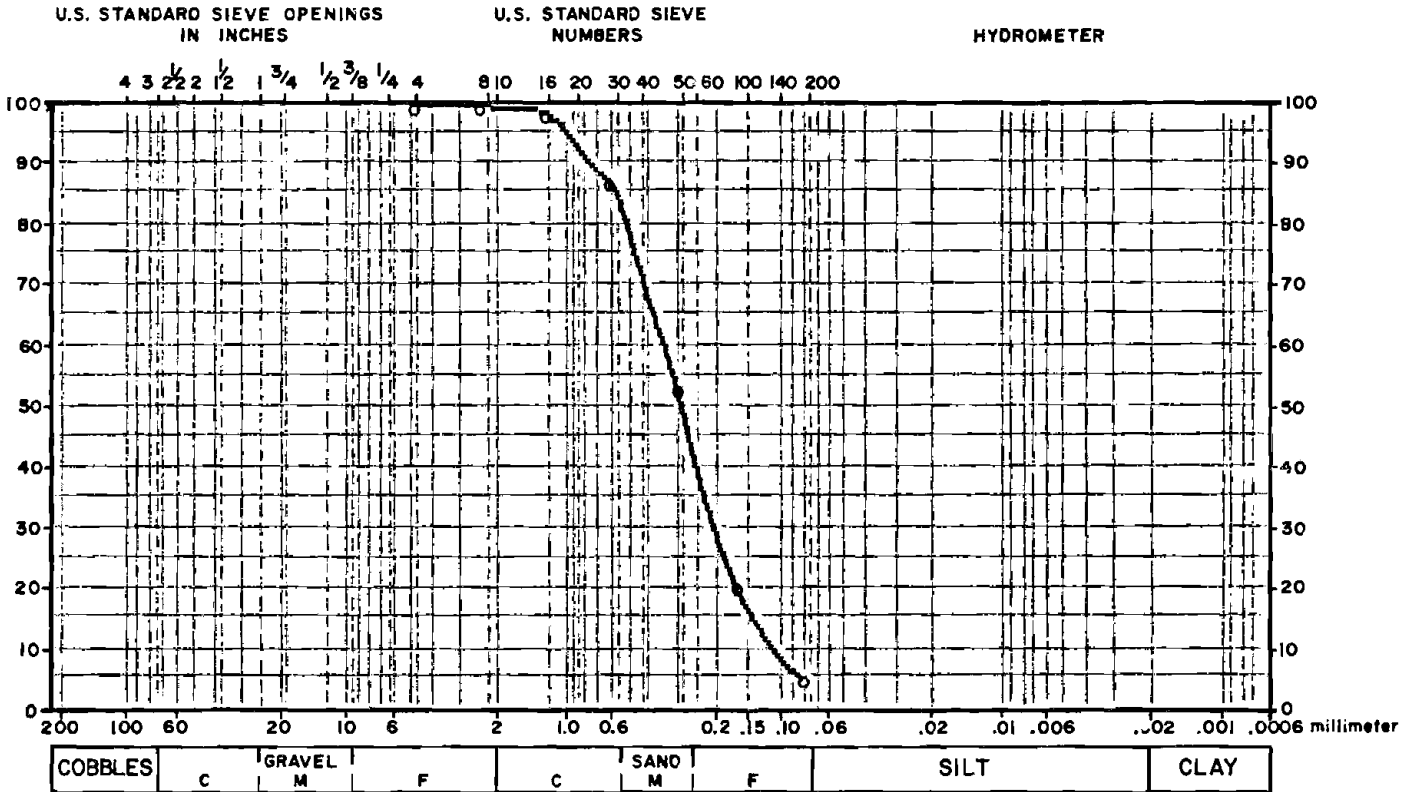

COARSE				FINE				HYDROMETER		
SIZE (Inches)	PERCENT RETAINED	CUMULATIVE PERCENT PASSING	SPECS.	SIEVE	PERCENT RETAINED	CUMULATIVE PERCENT PASSING	SPECS.	PARTICLE DIAMETER (mm)	PERCENT PASSING	SPECS.
-	0.00	0.00	-	4	0.00	100.00	-	-	-	-
-	0.00	0.00	-	8	.12	99.88	-	-	-	-
-	0.00	0.00	-	16	.99	98.89	-	-	-	-
-	0.00	0.00	-	30	11.34	87.55	-	-	-	-
-	0.00	0.00	-	50	34.29	53.26	-	-	-	-
-	0.00	0.00	-	100	32.54	20.72	-	-	-	-
-	0.00	0.00	-	200	15.67	5.05	-	-	-	-
-	0.00	0.00	-	-	0.00	0.00	-	-	-	-
-	0.00	0.00	-	-	0.00	0.00	-	-	-	-
-	0.00	0.00	-	-	0.00	0.00	-	-	-	-
-	0.00	0.00	-	-	0.00	0.00	-	-	-	-
-	0.00	0.00	-	-	0.00	0.00	-	-	-	-
-	0.00	0.00	-	-	0.00	0.00	-	-	-	-

PAN = 5.1%
 WASH LOSS WAS NOT TESTED.

SPECIFICATION: ASTM C-136
 TEST STANDARD: NONE
 NOTES: NONE

Dunn Geoscience Laboratory

5 Northway Lane North, Latham, NY 12110 (518) 783-8102

CLIENT:	GENERAL ELECTRIC COMPANY	NOTT STREET
LAB NUMBER:	12914	DATE RECEIVED: 7/5/84
TEST BY:	JWH	DATE TESTED: 7/10/84
REVIEWED BY:	<i>MJZ</i>	DATE REPORTED: 7/10/84
SAMPLE DESCR:	BOILING DGC 3S S-1	25.0' - 27.0'

GRAIN SIZE DISTRIBUTION

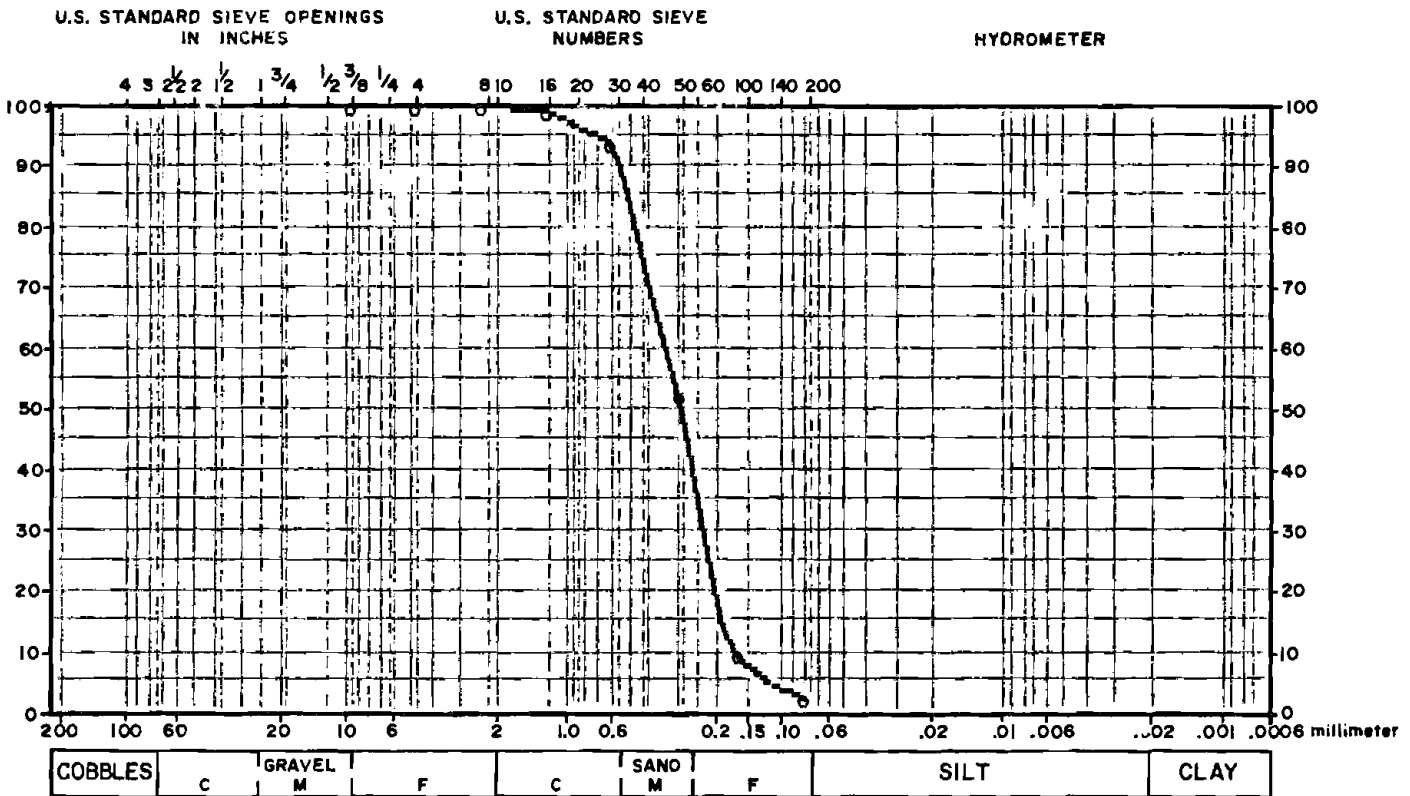

COARSE				FINE				HYDROMETER		
SIZE (inches)	PERCENT RETAINED	CUMULATIVE PERCENT PASSING	SPECS.	SIEVE	PERCENT RETAINED	CUMULATIVE PERCENT PASSING	SPECS.	PARTICLE DIAMETER (mm)	PERCENT PASSING	SPECS.
3/8	0.00	100.00	-	4	.12	99.88	-			
-	0.00	0.00	-	8	0.00	99.88	-			
-	0.00	0.00	-	16	.42	99.46	-			
-	0.00	0.00	-	30	5.42	94.04	-			
-	0.00	0.00	-	50	41.63	52.41	-			
-	0.00	0.00	-	100	42.23	10.18	-			
-	0.00	0.00	-	200	7.50	2.68	-			
-	0.00	0.00	-	-	0.00	0.00	-			
-	0.00	0.00	-	-	0.00	0.00	-			
-	0.00	0.00	-	-	0.00	0.00	-			
-	0.00	0.00	-	-	0.00	0.00	-			

PAN = 2.7%
WASH LOSS WAS NOT TESTED.

SPECIFICATION: ASTM C-136
TEST STANDARD: NONE
NOTES: NONE

Dunn Geoscience Laboratory

5 Northway Lane North, Latham, NY 12110 (518) 783-8102

CLIENT: GENERAL ELECTRIC COMPANY NOTT STREET
 LAB NUMBER: 12915 DATE RECEIVED: 7/5/84
 TEST BY: JWH DATE TESTED: 7/10/84
 REVIEWED BY: *MJZ* DATE REPORTED: 7/10/84
 SAMPLE DESCR: BORING DGC - 4 S-9 40.0' - 42.0'

GRAIN SIZE DISTRIBUTION

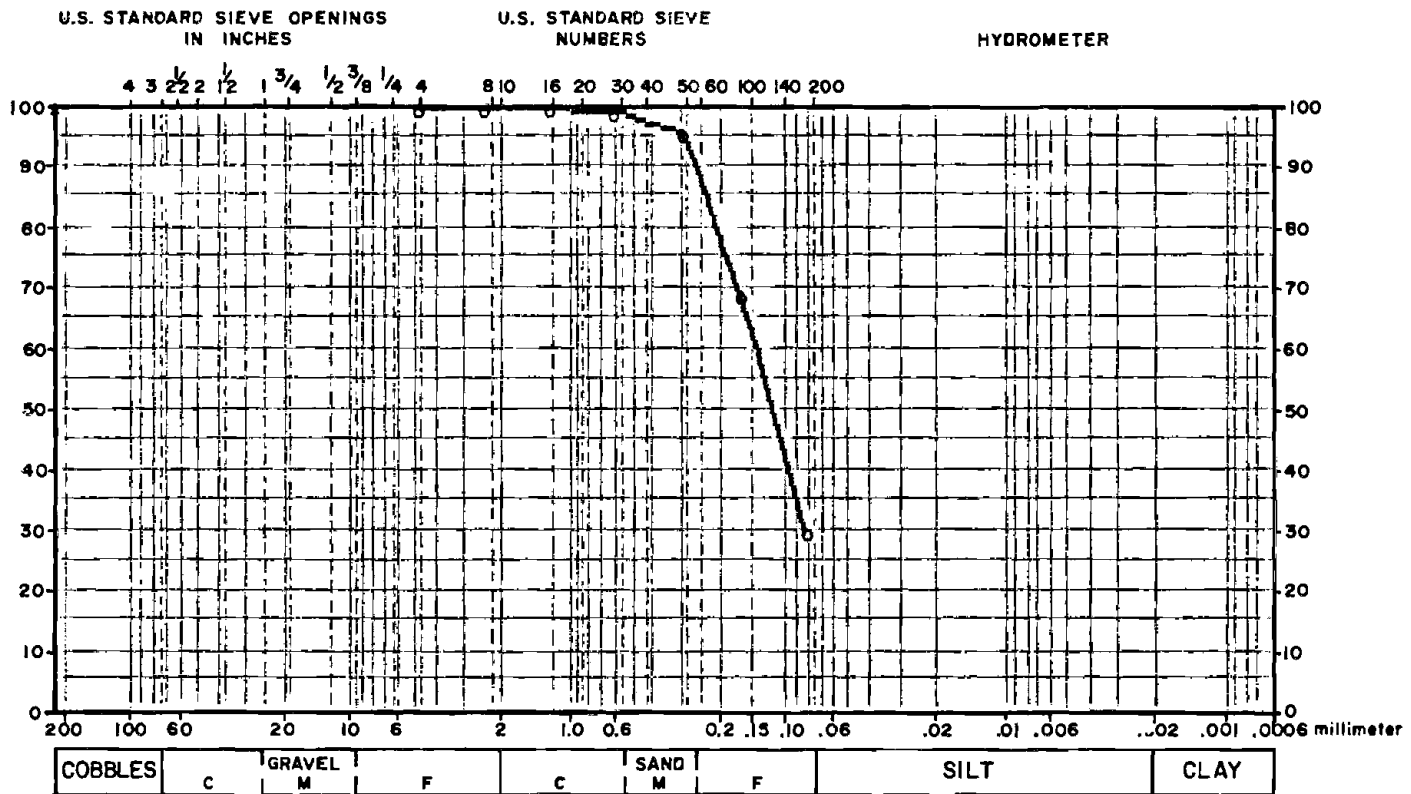

COARSE			
SIZE (Inches)	PERCENT RETAINED	CUMULATIVE PERCENT PASSING	SPECS.
-	0.00	0.00	-
-	0.00	0.00	-
-	0.00	0.00	-
-	0.00	0.00	-
-	0.00	0.00	-
-	0.00	0.00	-
-	0.00	0.00	-
-	0.00	0.00	-
-	0.00	0.00	-
-	0.00	0.00	-
-	0.00	0.00	-

FINE			
SIEVE	PERCENT RETAINED	CUMULATIVE PERCENT PASSING	SPECS.
4	0.00	100.00	-
8	0.00	100.00	-
16	.21	99.79	-
30	.31	99.48	-
50	3.58	95.90	-
100	26.60	69.30	-
200	39.32	29.97	-
-	0.00	0.00	-
-	0.00	0.00	-
-	0.00	0.00	-
-	0.00	0.00	-
-	0.00	0.00	-

HYDROMETER		
PARTICLE DIAMETER (mm)	PERCENT PASSING	SPECS.
-	-	-
-	-	-
-	-	-
-	-	-
-	-	-
-	-	-

PAN = 30.0%
 WASH LOSS WAS NOT TESTED.

SPECIFICATION: ASTM C 136

TEST STANDARD: NONE

NOTES: NONE

Dunn Geoscience Laboratory

5 Northway Lane North, Latham, NY 12110 (518) 783-8102

CLIENT: GENERAL ELECTRIC COMPANY NOTT STREET
 LAB NUMBER: 12916 DATE RECEIVED: 7/5/84
 TEST BY: JWH DATE TESTED: 7/17/84
 REVIEWED BY: *MJ3* DATE REPORTED: 7/24/84
 SAMPLE DESCR: BORING DGC-4 S-12 46.0'-48.0'

GRAIN SIZE DISTRIBUTION

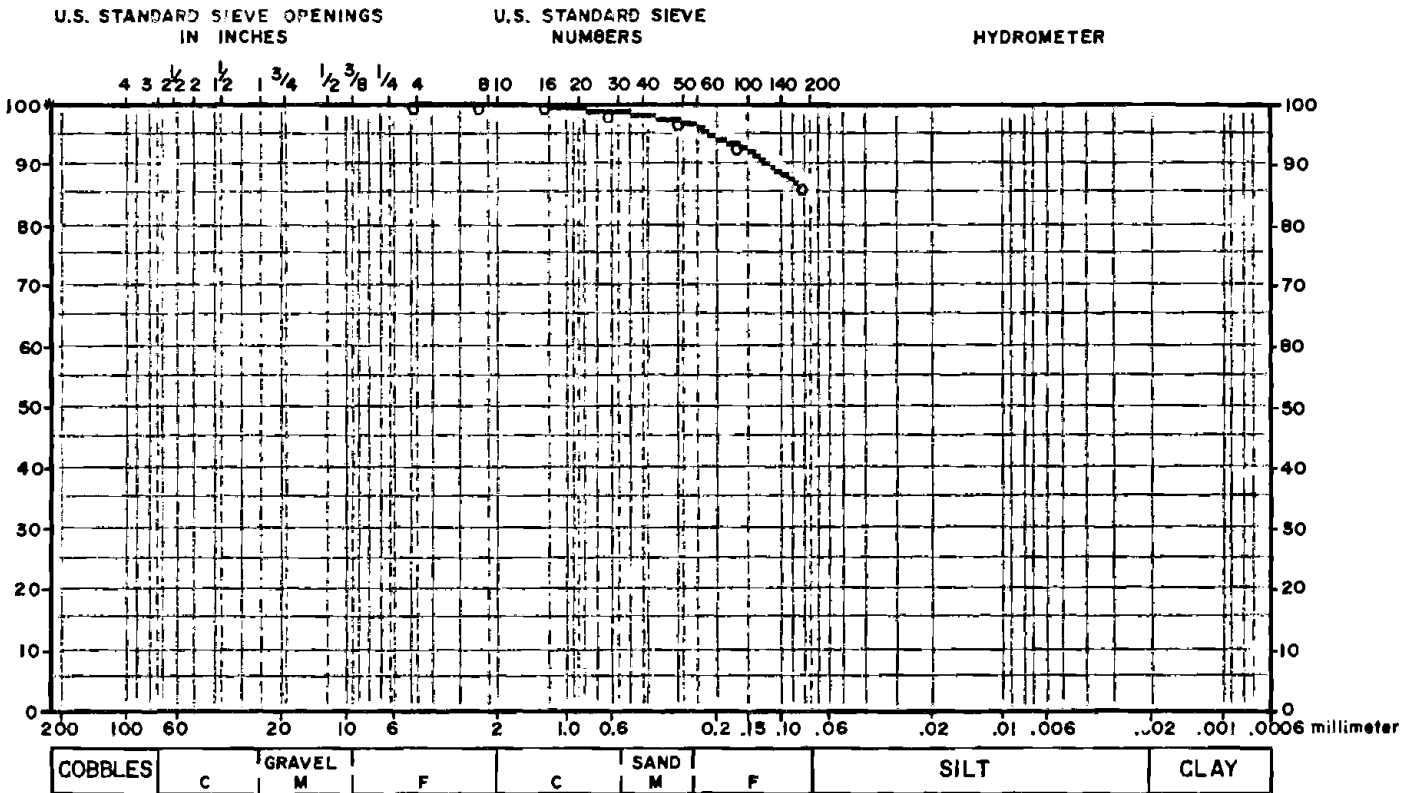

COARSE			
SIZE (inches)	PERCENT RETAINED	CUMULATIVE PERCENT PASSING	SPECS.
-	0.00	0.00	-
-	0.00	0.00	-
-	0.00	0.00	-
-	0.00	0.00	-
-	0.00	0.00	-
-	0.00	0.00	-
-	0.00	0.00	-
-	0.00	0.00	-
-	0.00	0.00	-
-	0.00	0.00	-
-	0.00	0.00	-
-	0.00	0.00	-
-	0.00	0.00	-
-	0.00	0.00	-
-	0.00	0.00	-

FINE			
SIEVE	PERCENT RETAINED	CUMULATIVE PERCENT PASSING	SPECS.
4	0.00	100.00	-
8	.08	99.92	-
16	.23	99.69	-
30	.92	98.78	-
50	1.60	97.17	-
100	3.74	93.43	-
200	7.64	85.79	-
-	0.00	0.00	-
-	0.00	0.00	-
-	0.00	0.00	-
-	0.00	0.00	-
-	0.00	0.00	-
-	0.00	0.00	-

HYDROMETER		
PARTICLE DIAMETER (mm)	PERCENT PASSING	SPECS.
-	-	-
-	-	-
-	-	-
-	-	-
-	-	-
-	-	-
-	-	-
-	-	-
-	-	-
-	-	-
-	-	-
-	-	-
-	-	-
-	-	-
-	-	-

PAN = 85.8%
 WASH LOSS = 84.7%

SPECIFICATION: ASTM C-136 ASTM C-117

TEST STANDARD: NONE
 NOTES: NONE

Test samples are retained for 30 days after submission

Dunn Geoscience Laboratory

5 Northway Lane North, Latham, NY 12110 (518) 783-8102

CLIENT: GENERAL ELECTRIC COMPANY NOTT STREET
 LAB NUMBER: 12917 DATE RECEIVED: 7/5/84
 TEST BY: JWH DATE TESTED: 7/10/84
 REVIEWED BY: *MJZ* DATE REPORTED: 7/10/84
 SAMPLE DESCR: BORING DGC 41 S-1 29.0' - 31.0'

GRAIN SIZE DISTRIBUTION

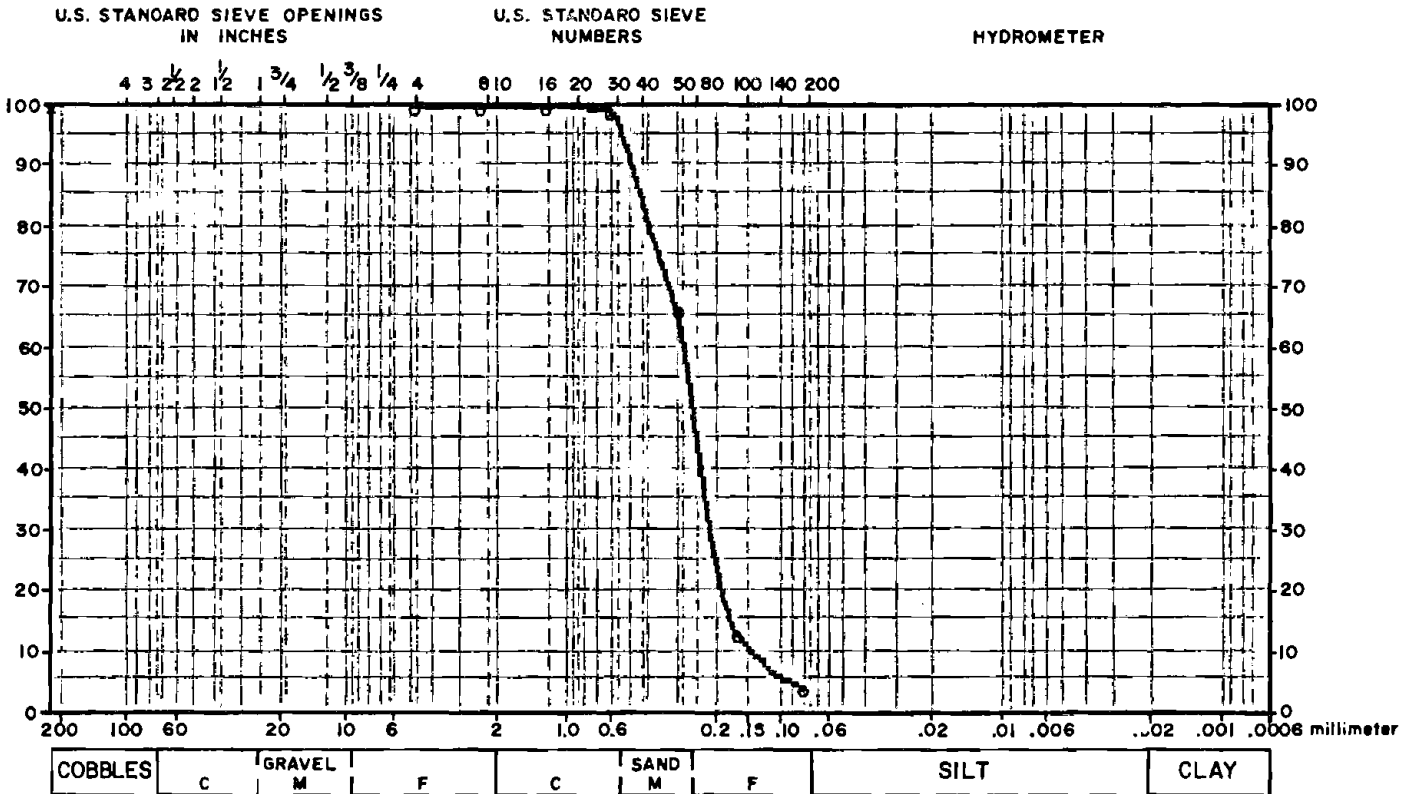

COARSE			
SIZE (inches)	PERCENT RETAINED	CUMULATIVE PERCENT PASSING	SPECS.
-	0.00	0.00	-
-	0.00	0.00	-
-	0.00	0.00	-
-	0.00	0.00	-
-	0.00	0.00	-
-	0.00	0.00	-
-	0.00	0.00	-
-	0.00	0.00	-
-	0.00	0.00	-
-	0.00	0.00	-
-	0.00	0.00	-
-	0.00	0.00	-
-	0.00	0.00	-
-	0.00	0.00	-
-	0.00	0.00	-

FINE			
SIEVE	PERCENT RETAINED	CUMULATIVE PERCENT PASSING	SPECS.
4	0.00	100.00	-
8	0.00	100.00	-
16	0.00	100.00	-
30	.40	99.60	-
50	32.93	66.67	-
100	53.07	13.60	-
200	9.77	3.83	-
-	0.00	0.00	-
-	0.00	0.00	-
-	0.00	0.00	-
-	0.00	0.00	-
-	0.00	0.00	-
-	0.00	0.00	-
-	0.00	0.00	-

HYDROMETER		
PARTICLE DIAMETER (mm)	PERCENT PASSING	SPECS.
-	-	-
-	-	-
-	-	-
-	-	-
-	-	-
-	-	-
-	-	-
-	-	-
-	-	-
-	-	-
-	-	-
-	-	-
-	-	-
-	-	-
-	-	-

PAN = 3.8%
 WASH LOSS WAS NOT TESTED.

SPECIFICATION: ASTM C-136

TEST STANDARD: NONE

NOTES: NONE

Dunn Geoscience Laboratory

5 Northway Lane North, Latham, NY 12110 (518) 783-8102

CLIENT: GENERAL ELECTRIC COMPANY, NOTT ST.
 LAB NUMBER: 12918 DATE RECEIVED: 7/5/84
 TEST BY: JWH DATE TESTED: 7/16/84
 REVIEWED BY: *JH* DATE REPORTED: 7/17/84
 SAMPLE DESCR: BORING DGC 4 S, S-1, 12.0'-14.0'

GRAIN SIZE DISTRIBUTION

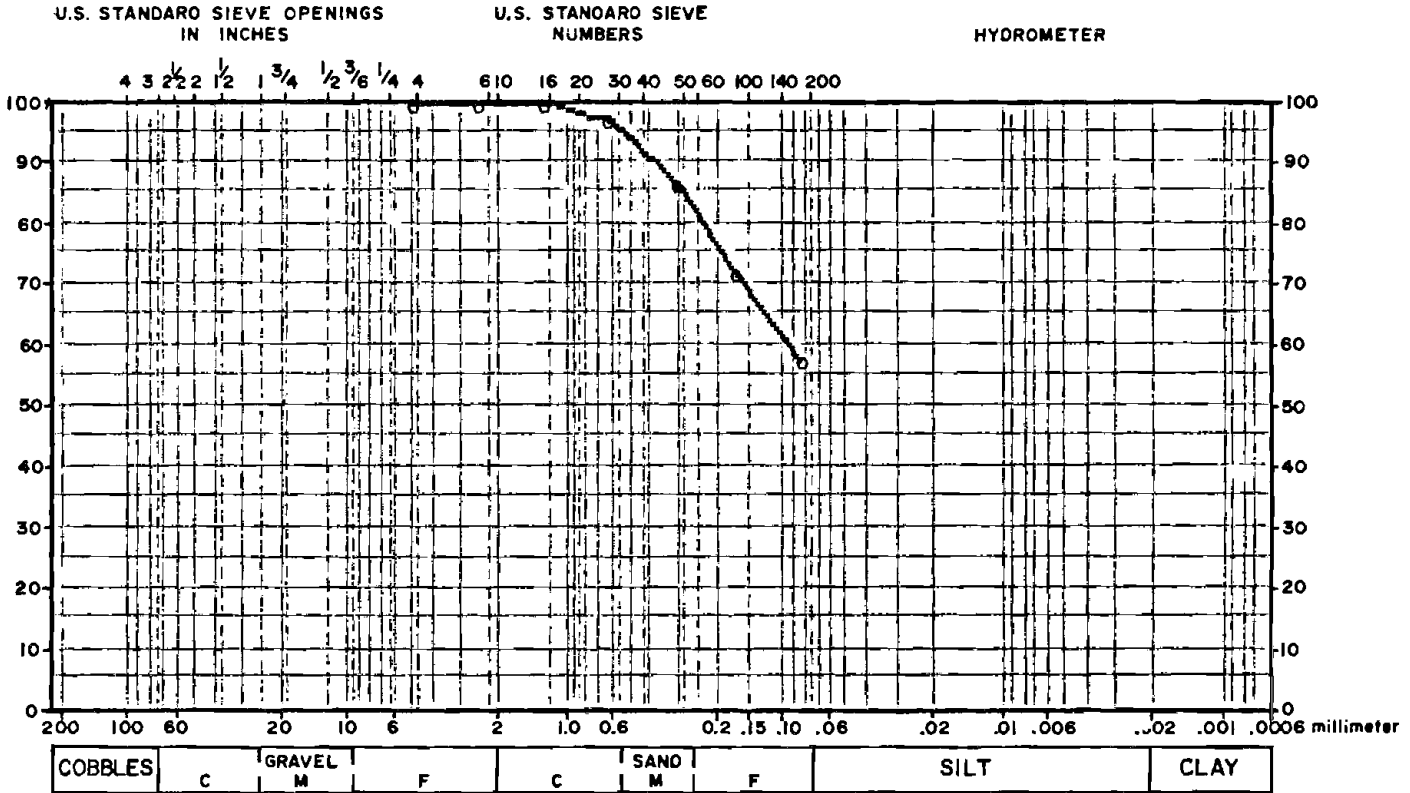

COARSE				FINE				HYDROMETER		
SIZE (inches)	PERCENT RETAINED	CUMULATIVE PERCENT PASSING	SPECS.	SIEVE	PERCENT RETAINED	CUMULATIVE PERCENT PASSING	SPECS.	PARTICLE DIAMETER (mm)	PERCENT PASSING	SPECS.
-	0.00	0.00	-	4	0.00	100.00	-			
-	0.00	0.00	-	8	0.00	100.00	-			
-	0.00	0.00	-	16	0.00	100.00	-			
-	0.00	0.00	-	30	2.99	97.01	-			
-	0.00	0.00	-	50	10.32	86.68	-			
-	0.00	0.00	-	100	14.39	72.30	-			
-	0.00	0.00	-	200	14.76	57.54	-			
-	0.00	0.00	-	-	0.00	0.00	-			
-	0.00	0.00	-	-	0.00	0.00	-			
-	0.00	0.00	-	-	0.00	0.00	-			
-	0.00	0.00	-	-	0.00	0.00	-			
-	0.00	0.00	-	-	0.00	0.00	-			

PAN = 57.5%
 WASH LOSS WAS NOT TESTED.

SPECIFICATION: ASTM C 136

TEST STANDARD: NA

NOTES: NONE

Dunn Geoscience Laboratory

5 Northway Lane North, Latham, NY 12110 (518) 783-8102

CLIENT: GENERAL ELECTRIC COMPANY NOTT STREET
 LAB NUMBER: 12919 DATE RECEIVED: 7/5/84
 TEST BY: JWH DATE TESTED: 7/9/84
 REVIEWED BY: *MJZ* DATE REPORTED: 7/10/84
 SAMPLE DESCR: BORING DGC 5 S-17 65' - 67'

GRAIN SIZE DISTRIBUTION

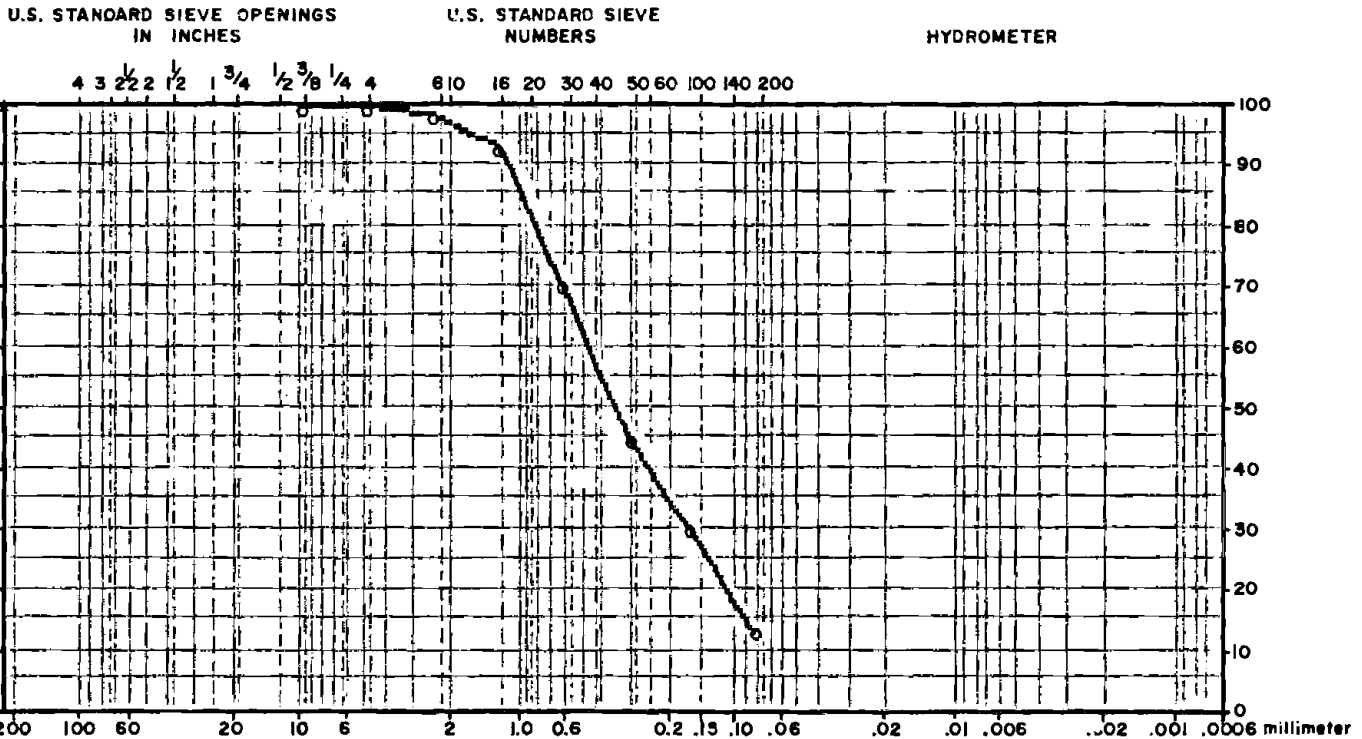

COBBLES	GRAVEL			SAND			SILT	CLAY
	C	M	F	C	M	F		

COARSE				FINE				HYDROMETER		
SIZE (Inches)	PERCENT RETAINED	CUMULATIVE PERCENT PASSING	SPECS.	SIEVE	PERCENT RETAINED	CUMULATIVE PERCENT PASSING	SPECS.	PARTICLE DIAMETER (mm)	PERCENT PASSING	SPECS.
3/8	0.00	100.00	-	4	.10	99.90	-			
-	0.00	0.00	-	8	1.24	98.66	-			
-	0.00	0.00	-	16	5.08	93.58	-			
-	0.00	0.00	-	30	22.77	70.81	-			
-	0.00	0.00	-	50	25.24	45.57	-			
-	0.00	0.00	-	100	15.08	30.49	-			
-	0.00	0.00	-	200	17.23	13.26	-			
-	0.00	0.00	-	-	0.00	0.00	-			
-	0.00	0.00	-	-	0.00	0.00	-			
-	0.00	0.00	-	-	0.00	0.00	-			
-	0.00	0.00	-	-	0.00	0.00	-			
-	0.00	0.00	-	-	0.00	0.00	-			

PAN = 13.3%
 WASH LOSS WAS NOT TESTED.

PECIFICATION: ASTM C-136

TEST STANDARD: NONE

NOTES: NONE

Dunn Geoscience Laboratory

5 Northway Lane North, Latham, NY 12110 (518) 783-8102

CLIENT: GENERAL ELECTRIC COMPANY NOTT STREET
 LAB NUMBER: 12920 DATE RECEIVED: 7/5/84
 TEST BY: JWH DATE TESTED: 7/9/84
 REVIEWED BY: *MJZ* DATE REPORTED: 7/10/84
 SAMPLE DESCR: BORING DGC 5 S-20 80' - 82'

GRAIN SIZE DISTRIBUTION

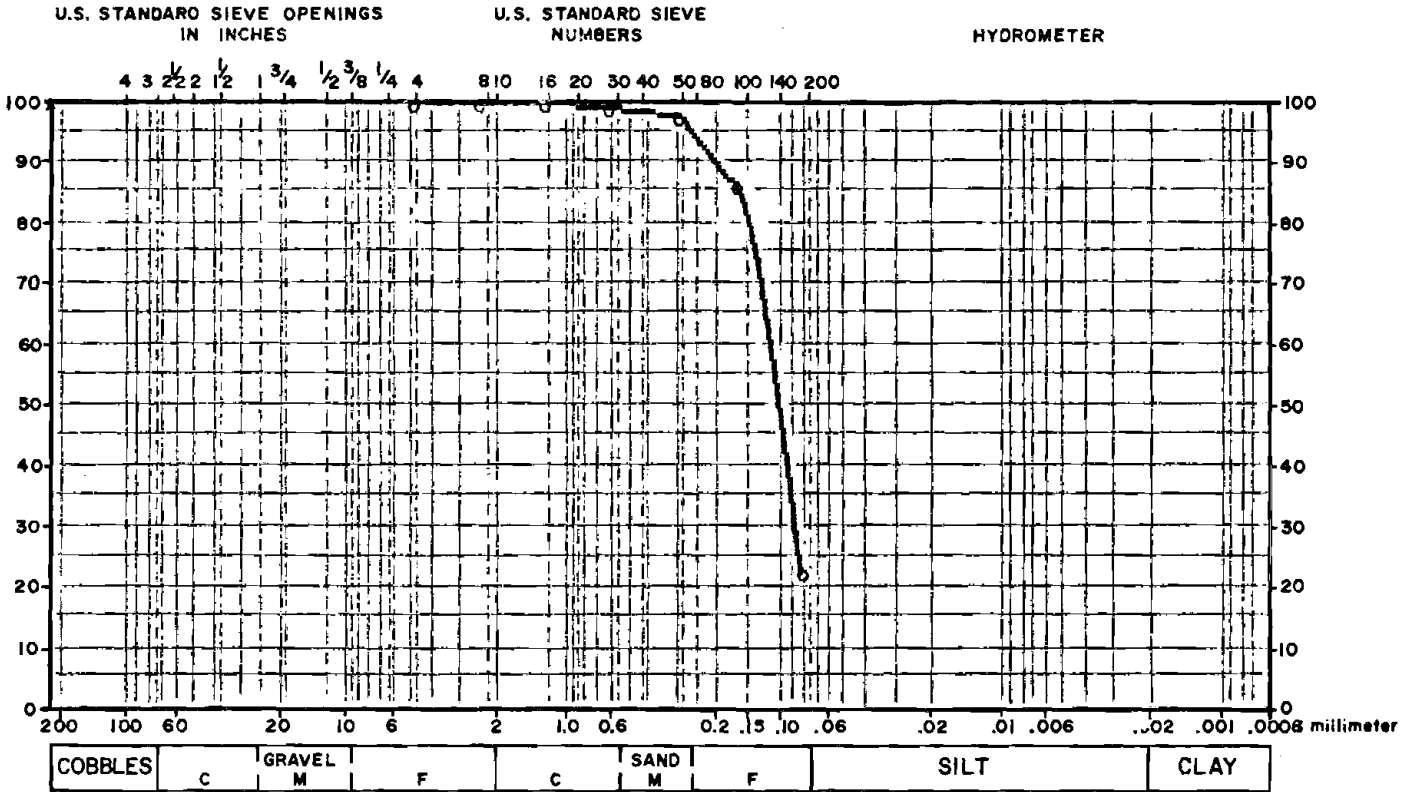

COARSE				FINE				HYDROMETER		
SIZE (inches)	PERCENT RETAINED	CUMULATIVE PERCENT PASSING	SPECS.	SIEVE	PERCENT RETAINED	CUMULATIVE PERCENT PASSING	SPECS.	PARTICLE DIAMETER (mm)	PERCENT PASSING	SPECS.
-	0.00	0.00	-	4	0.00	100.00	-			
-	0.00	0.00	-	8	0.00	100.00	-			
-	0.00	0.00	-	16	.04	99.96	-			
-	0.00	0.00	-	30	.65	99.31	-			
-	0.00	0.00	-	50	1.23	98.08	-			
-	0.00	0.00	-	100	11.26	86.82	-			
-	0.00	0.00	-	200	63.91	22.91	-			
-	0.00	0.00	-	-	0.00	0.00	-			
-	0.00	0.00	-	-	0.00	0.00	-			
-	0.00	0.00	-	-	0.00	0.00	-			
-	0.00	0.00	-	-	0.00	0.00	-			

PAN = 22.9%
WASH LOSS WAS NOT TESTED.

SPECIFICATION: ASTM C-136
 TEST STANDARD: NONE
 NOTES: NONE

Dunn Geoscience Laboratory

5 Northway Lane North, Latham, NY 12110 (518) 783-8102

CLIENT: GENERAL ELECTRIC COMPANY NOTT STREET
 LAB NUMBER: 12921 DATE RECEIVED: 7/5/84
 TEST BY: JWH DATE TESTED: 7/9/84
 REVIEWED BY: *MJZ* DATE REPORTED: 7/10/84
 SAMPLE DESCR: BORING DGC 51 S-2 48.5' - 50.5'

GRAIN SIZE DISTRIBUTION

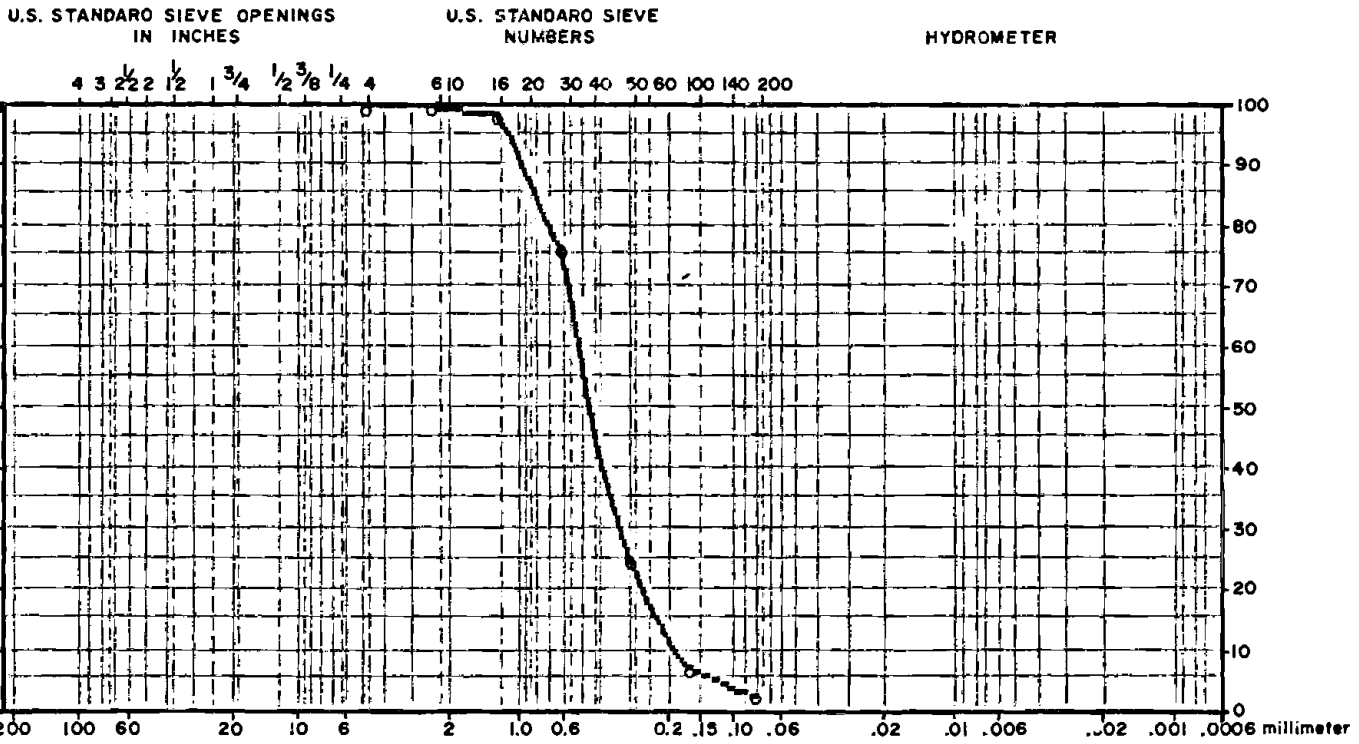

COBBLES	C	GRAVEL	M	F	SAND	C	M	F	SILT	CLAY
---------	---	--------	---	---	------	---	---	---	------	------

COARSE

SIZE (Inches)	PERCENT RETAINED	CUMULATIVE PERCENT PASSING	SPECS.
-	0.00	0.00	-
-	0.00	0.00	-
-	0.00	0.00	-
-	0.00	0.00	-
-	0.00	0.00	-
-	0.00	0.00	-
-	0.00	0.00	-
-	0.00	0.00	-
-	0.00	0.00	-
-	0.00	0.00	-
-	0.00	0.00	-
-	0.00	0.00	-
-	0.00	0.00	-
-	0.00	0.00	-
-	0.00	0.00	-
-	0.00	0.00	-
-	0.00	0.00	-

FINE

SIEVE	PERCENT RETAINED	CUMULATIVE PERCENT PASSING	SPECS.
4	0.00	100.00	-
8	.18	99.82	-
16	1.48	98.34	-
30	21.85	76.49	-
50	51.01	25.48	-
100	17.90	7.58	-
200	4.62	2.96	-
-	0.00	0.00	-
-	0.00	0.00	-
-	0.00	0.00	-
-	0.00	0.00	-
-	0.00	0.00	-
-	0.00	0.00	-
-	0.00	0.00	-
-	0.00	0.00	-
-	0.00	0.00	-
-	0.00	0.00	-
-	0.00	0.00	-

HYDROMETER

PARTICLE DIAMETER (mm)	PERCENT PASSING	SPECS.
-	0.00	-
-	0.00	-
-	0.00	-
-	0.00	-
-	0.00	-
-	0.00	-
-	0.00	-
-	0.00	-
-	0.00	-
-	0.00	-
-	0.00	-
-	0.00	-
-	0.00	-
-	0.00	-
-	0.00	-
-	0.00	-
-	0.00	-

PAN = 3.0%

WASH LOSS WAS NOT TESTED.

SPECIFICATION: ASTM C-136

TEST STANDARD: NONE

NOTES: NONE

Dunn Geoscience Laboratory

5 Northway Lane North, Latham, NY 12110 (518) 783-8102

CLIENT:	GENERAL ELECTRIC COMPANY	NOTT STREET
LAB NUMBER:	12922	DATE RECEIVED: 7/5/84
TEST BY:	JWH	DATE TESTED: 7/9/84
REVIEWED BY:	<i>MJZ</i>	DATE REPORTED: 7/10/84
SAMPLE DESCR:	BORING DGC 55 S-1 26' - 28'	

GRAIN SIZE DISTRIBUTION

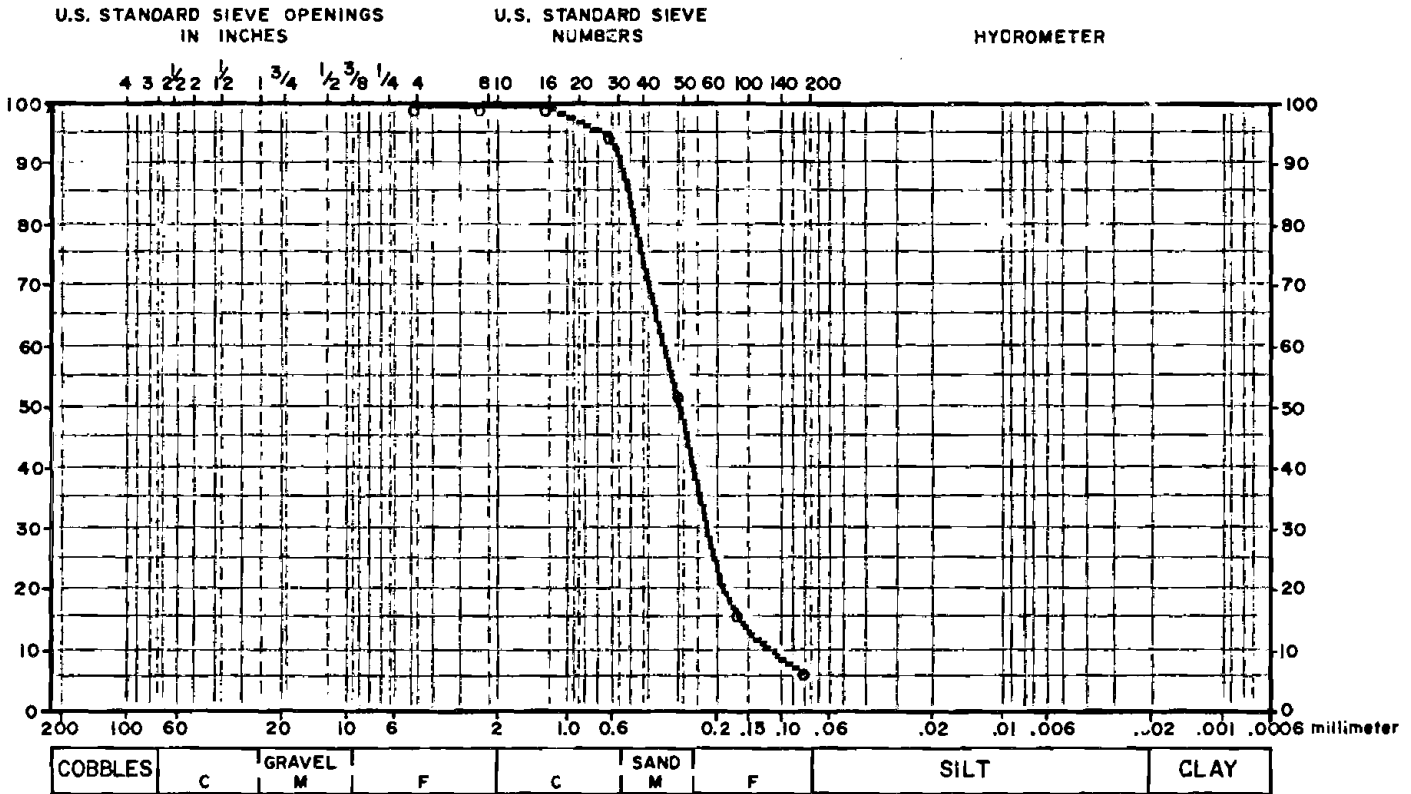

COARSE				FINE				HYDROMETER		
SIZE (Inches)	PERCENT RETAINED	CUMULATIVE PERCENT PASSING	SPECS.	SIEVE	PERCENT RETAINED	CUMULATIVE PERCENT PASSING	SPECS.	PARTICLE DIAMETER (mm)	PERCENT PASSING	SPECS.
-	0.00	0.00	-	4	0.00	100.00	-			
-	0.00	0.00	-	8	0.00	100.00	-			
-	0.00	0.00	-	16	.15	99.85	-			
-	0.00	0.00	-	30	4.37	95.48	-			
-	0.00	0.00	-	50	42.75	52.73	-			
-	0.00	0.00	-	100	36.27	16.46	-			
-	0.00	0.00	-	200	9.61	6.85	-			
-	0.00	0.00	-	-	0.00	0.00	-			
-	0.00	0.00	-	-	0.00	0.00	-			
-	0.00	0.00	-	-	0.00	0.00	-			
-	0.00	0.00	-	-	0.00	0.00	-			
-	0.00	0.00	-	-	0.00	0.00	-			

PAN = 6.8%
WASH LOSS WAS NOT TESTED.

SPECIFICATION: ASTM C-136
TEST STANDARD: NONE
NOTES: NONE

Dunn Geoscience Laboratory

5 Northway Lane North, Latham, NY 12110 (518) 783-8102

CLIENT: GENERAL ELECTRIC COMPANY, NOTT ST.
 LAB NUMBER: 12923 DATE RECEIVED: 7/5/84
 TEST BY: JWH DATE TESTED: 7/11/84
 REVIEWED BY: *JAL* DATE REPORTED: 7/17/84
 SAMPLE DESCR: BORING DGC 6, S-40, 78.0'-80.0'

GRAIN SIZE DISTRIBUTION

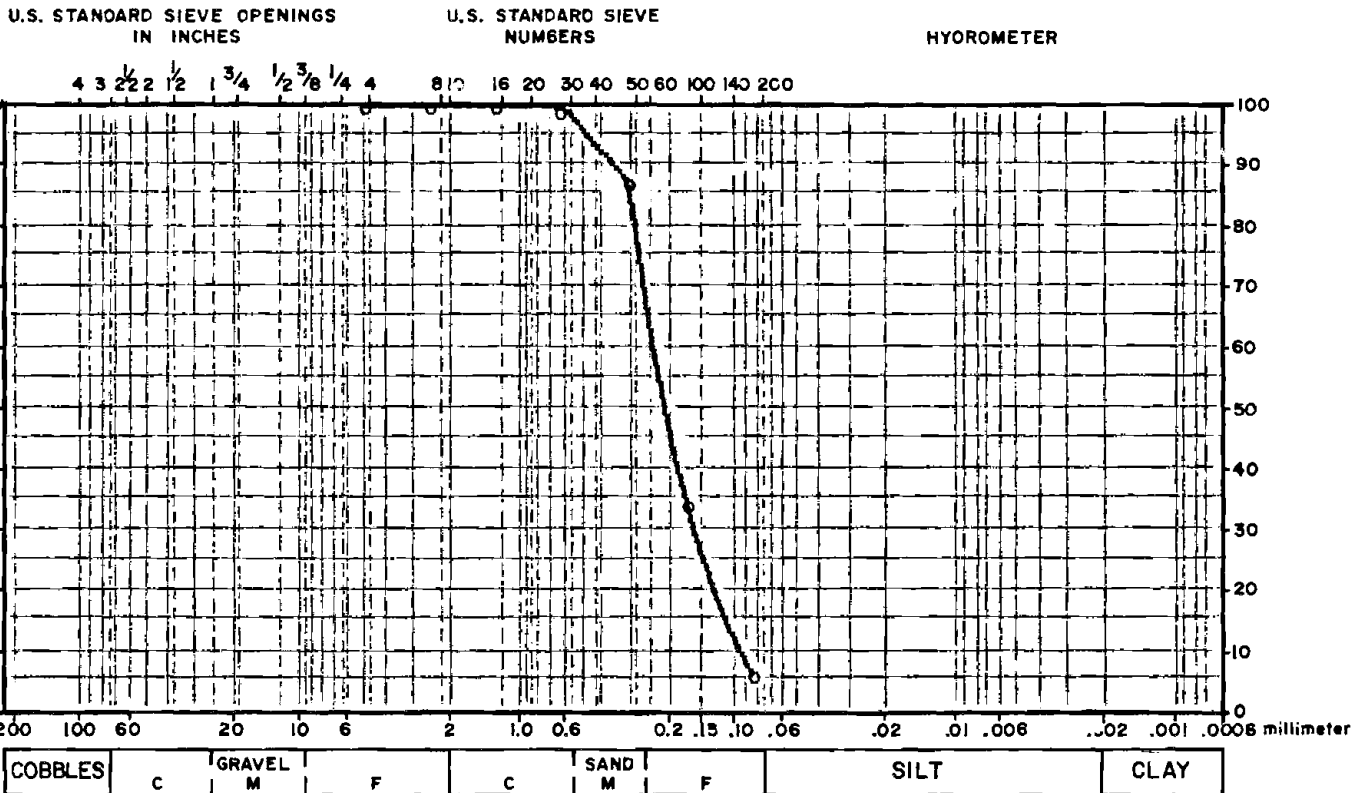

COARSE

FINE

HYDROMETER

SIZE (inches)	PERCENT RETAINED	CUMULATIVE PERCENT PASSING	SPECS.
-	0.00	0.00	-
-	0.00	0.00	-
-	0.00	0.00	-
-	0.00	0.00	-
-	0.00	0.00	-
-	0.00	0.00	-
-	0.00	0.00	-
-	0.00	0.00	-
-	0.00	0.00	-
-	0.00	0.00	-
-	0.00	0.00	-
-	0.00	0.00	-
-	0.00	0.00	-
-	0.00	0.00	-
-	0.00	0.00	-

SIEVE	PERCENT RETAINED	CUMULATIVE PERCENT PASSING	SPECS.
4	0.00	100.00	-
8	0.00	100.00	-
16	.04	99.96	-
30	.34	99.62	-
50	12.00	87.62	-
100	53.23	34.38	-
200	28.21	6.17	-
-	0.00	0.00	-
-	0.00	0.00	-
-	0.00	0.00	-
-	0.00	0.00	-
-	0.00	0.00	-
-	0.00	0.00	-
-	0.00	0.00	-

PARTICLE DIAMETER (mm)	PERCENT PASSING	SPECS.
-	-	-
-	-	-
-	-	-
-	-	-
-	-	-
-	-	-
-	-	-
-	-	-
-	-	-
-	-	-
-	-	-
-	-	-
-	-	-
-	-	-
-	-	-

PAN = 6.2%
 WASH LOSS WAS NOT TESTED.

SPECIFICATION: ASTM C 136
 TEST STANDARD: NA
 NOTES: NONE

Dunn Geoscience Laboratory

5 Northway Lane North, Latham, NY 12110 (518) 783-8102

CLIENT: GENERAL ELECTRIC COMPANY, NOTT ST.
 LAB NUMBER: 12924 DATE RECEIVED: 07/05/84
 TEST BY: JWH DATE TESTED: 07/11/84
 REVIEWED BY: *RH* DATE REPORTED: 7/17/84
 SAMPLE DESCR: BORING DGC 6 S-47, 92.0'-94.0'

GRAIN SIZE DISTRIBUTION

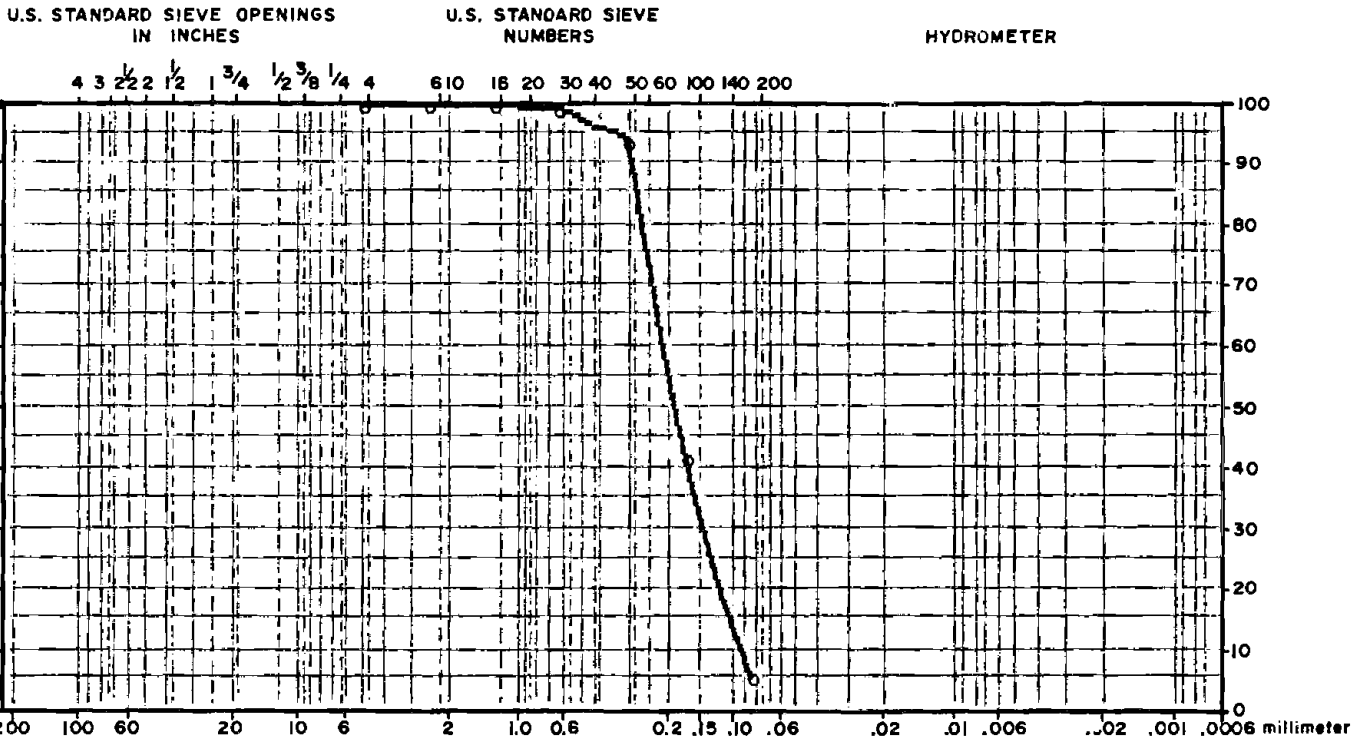

COBBLES	GRAVEL			SAND			SILT	CLAY
	C	M	F	C	M	F		

COARSE				FINE				HYDROMETER		
SIZE (Inches)	PERCENT RETAINED	CUMULATIVE PERCENT PASSING	SPECS.	SIEVE	PERCENT RETAINED	CUMULATIVE PERCENT PASSING	SPECS.	PARTICLE DIAMETER (mm)	PERCENT PASSING	SPECS.
-	0.00	0.00	-	4	0.00	100.00	-			
-	0.00	0.00	-	8	0.00	100.00	-			
-	0.00	0.00	-	16	.11	99.89	-			
-	0.00	0.00	-	30	.81	99.09	-			
-	0.00	0.00	-	50	4.99	94.10	-			
-	0.00	0.00	-	100	52.25	41.85	-			
-	0.00	0.00	-	200	36.59	5.27	-			
-	0.00	0.00	-	-	0.00	0.00	-			
-	0.00	0.00	-	-	0.00	0.00	-			
-	0.00	0.00	-	-	0.00	0.00	-			
-	0.00	0.00	-	-	0.00	0.00	-			
-	0.00	0.00	-	-	0.00	0.00	-			

PAN = 5.3%
 WASH LOSS WAS NOT TESTED.

SPECIFICATION: ASTM C 136

TEST STANDARD: NA

NOTES: NONE

Dunn Geoscience Laboratory

5 Northway Lane North, Latham, NY 12110 (518) 783-8102

CLIENT:	GENERAL ELECTRIC COMPANY	NOTT STREET
LAB NUMBER:	12925	DATE RECEIVED: 7/5/84
TEST BY:	JWH	DATE TESTED: 7/10/84
REVIEWED BY:	<i>MJZ</i>	DATE REPORTED: 7/10/84
SAMPLE DESCR:	BORING DGC 61 S-1 50.0' - 52.0'	

GRAIN SIZE DISTRIBUTION

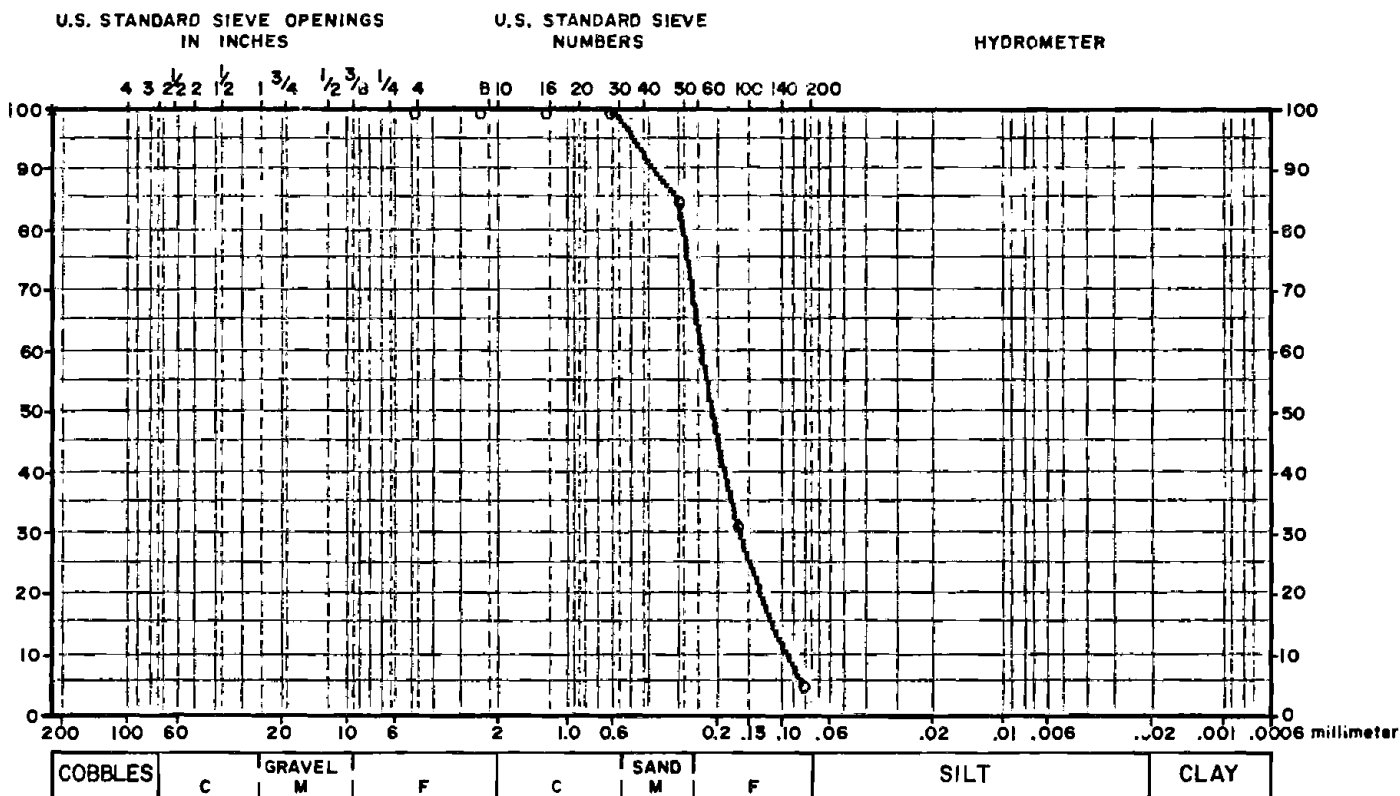

COARSE				FINE				HYDROMETER		
SIZE (inches)	PERCENT RETAINED	CUMULATIVE PERCENT PASSING	SPECS.	SIEVE	PERCENT RETAINED	CUMULATIVE PERCENT PASSING	SPECS.	PARTICLE DIAMETER (mm)	PERCENT PASSING	SPECS.
-	0.00	0.00	-	4	0.00	100.00	-			
-	0.00	0.00	-	8	.05	99.95	-			
-	0.00	0.00	-	16	.09	99.86	-			
-	0.00	0.00	-	30	.14	99.72	-			
-	0.00	0.00	-	50	14.51	85.21	-			
-	0.00	0.00	-	100	52.94	32.28	-			
-	0.00	0.00	-	200	26.73	5.55	-			
-	0.00	0.00	-	-	0.00	0.00	-			
-	0.00	0.00	-	-	0.00	0.00	-			
-	0.00	0.00	-	-	0.00	0.00	-			
-	0.00	0.00	-	-	0.00	0.00	-			
-	0.00	0.00	-	-	0.00	0.00	-			

PAN = 5.6%
WASH LOSS WAS NOT TESTED.

SPECIFICATION: ASTM C-136

TEST STANDARD: NONE

NOTES: NONE

Dunn Geoscience Laboratory

5 Northway Lane North, Latham, NY 12110 (518) 783-8102

CLIENT: GENERAL ELECTRIC COMPANY, NOTT ST.
 LAB NUMBER: 12926 DATE RECEIVED: 7/5/84
 TEST BY: JWH DATE TESTED: 7/11/84
 REVIEWED BY: *Jed* DATE REPORTED: 7/17/84
 SAMPLE DESCR: BORING DGC 6 S, S-1, 29.0'-31.0'

GRAIN SIZE DISTRIBUTION

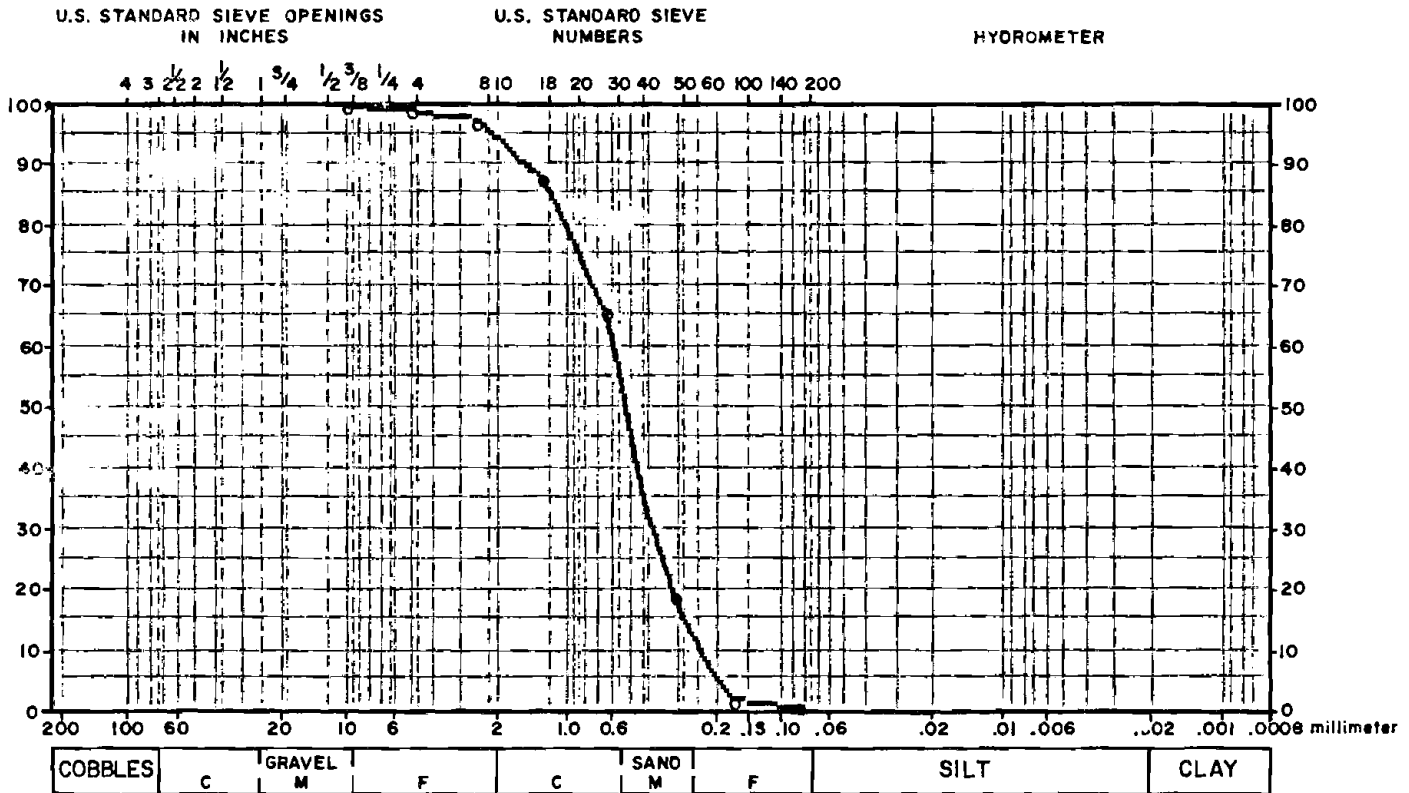

COARSE				FINE				HYDROMETER		
SIZE (inches)	PERCENT RETAINED	CUMULATIVE PERCENT PASSING	SPECS.	SIEVE	PERCENT RETAINED	CUMULATIVE PERCENT PASSING	SPECS.	PARTICLE DIAMETER (mm)	PERCENT PASSING	SPECS.
3/8	0.00	100.00	-	4	.95	99.05	-			
-	0.00	0.00	-	8	1.68	97.36	-			
-	0.00	0.00	-	16	9.66	87.70	-			
-	0.00	0.00	-	30	21.85	65.85	-			
-	0.00	0.00	-	50	46.56	19.29	-			
-	0.00	0.00	-	100	17.11	2.18	-			
-	0.00	0.00	-	200	1.53	.65	-			
-	0.00	0.00	-	-	0.00	0.00	-			
-	0.00	0.00	-	-	0.00	0.00	-			
-	0.00	0.00	-	-	0.00	0.00	-			
-	0.00	0.00	-	-	0.00	0.00	-			
-	0.00	0.00	-	-	0.00	0.00	-			

PAN = .6%
 WASH LOSS WAS NOT TESTED.

SPECIFICATION: ASTM C 136
 TEST STANDARD: NA
 NOTES: NONE

Dunn Geoscience Laboratory

5 Northway Lane North, Latham, NY 12110 (518) 783-8102

CLIENT: GENERAL ELECTRIC COMPANY, NOTT ST.
 LAB NUMBER: 12927 DATE RECEIVED: 7/5/84
 TEST BY: JWH DATE TESTED: 7/12/84
 REVIEWED BY: *PAT* DATE REPORTED: 7/17/84
 SAMPLE DESCR: BORING DGC 7, S-14, 65.0'-67.0'

GRAIN SIZE DISTRIBUTION

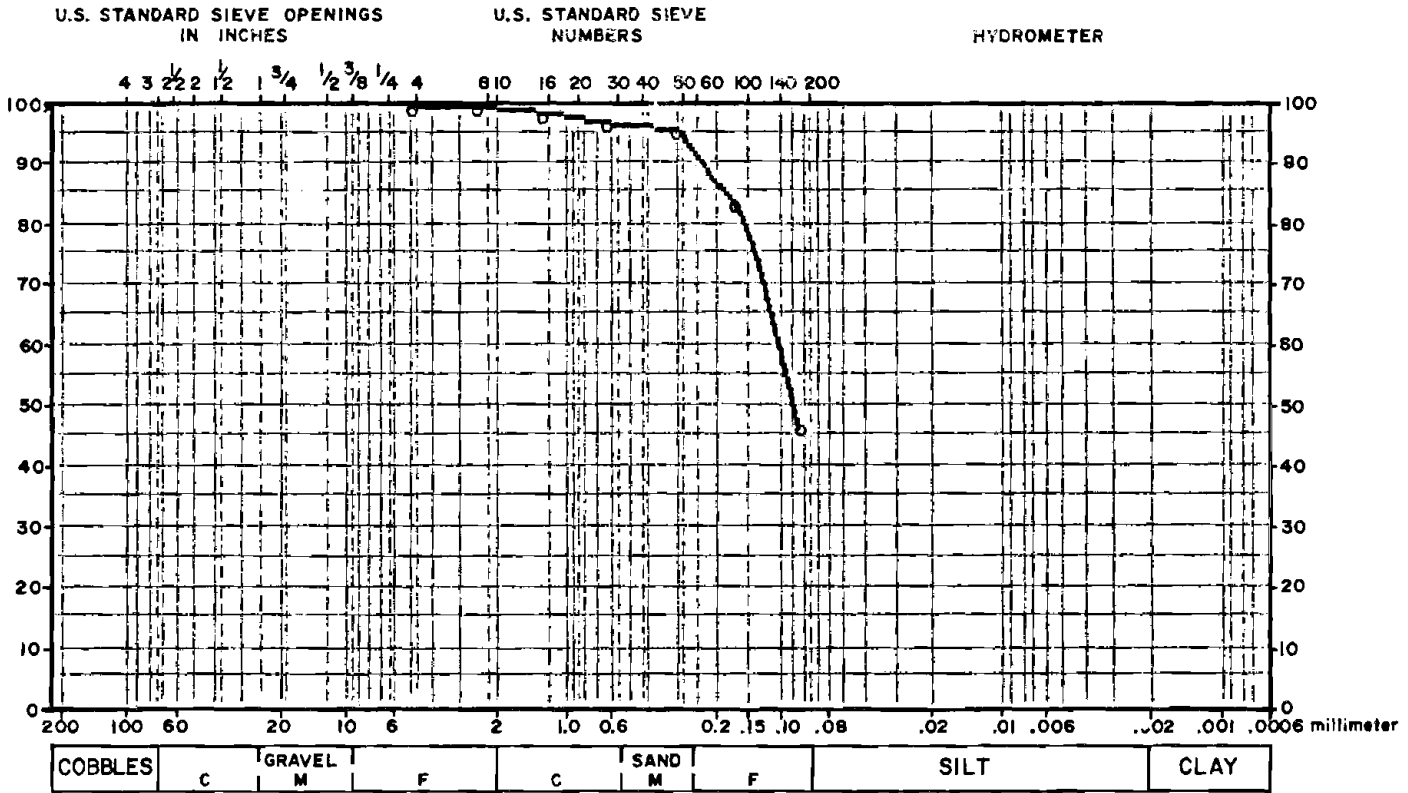

COARSE				FINE				HYDROMETER		
SIZE (Inches)	PERCENT RETAINED	CUMULATIVE PERCENT PASSING	SPECS.	SIEVE	PERCENT RETAINED	CUMULATIVE PERCENT PASSING	SPECS.	PARTICLE DIAMETER (mm)	PERCENT PASSING	SPECS.
-	0.00	0.00	-	4	0.00	100.00	-			
-	0.00	0.00	-	8	.08	99.92	-			
-	0.00	0.00	-	16	1.02	98.90	-			
-	0.00	0.00	-	30	1.75	97.15	-			
-	0.00	0.00	-	50	1.22	95.93	-			
-	0.00	0.00	-	100	11.77	84.16	-			
-	0.00	0.00	-	200	37.74	46.42	-			
-	0.00	0.00	-	-	0.00	0.00	-			
-	0.00	0.00	-	-	0.00	0.00	-			
-	0.00	0.00	-	-	0.00	0.00	-			
-	0.00	0.00	-	-	0.00	0.00	-			
-	0.00	0.00	-	-	0.00	0.00	-			

PAN = 46.4%
 WASH LOSS WAS NOT TESTED.

SPECIFICATION: ASTM C 136
 TEST STANDARD: NA
 NOTES: NONE

Dunn Geoscience Laboratory

5 Northway Lane North, Latham, NY 12110 (518) 783-8102

CLIENT:	GENERAL ELECTRIC COMPANY	NOTT STREET
LAB NUMBER:	12928	DATE RECEIVED: 7/5/84
TEST BY:	JWH	DATE TESTED: 7/17/84
REVIEWED BY:	<i>Mg3</i>	DATE REPORTED: 7/24/84
SAMPLE DESCR:	BORING DGC-7 S-18	85.0' - 87.0'

GRAIN SIZE DISTRIBUTION

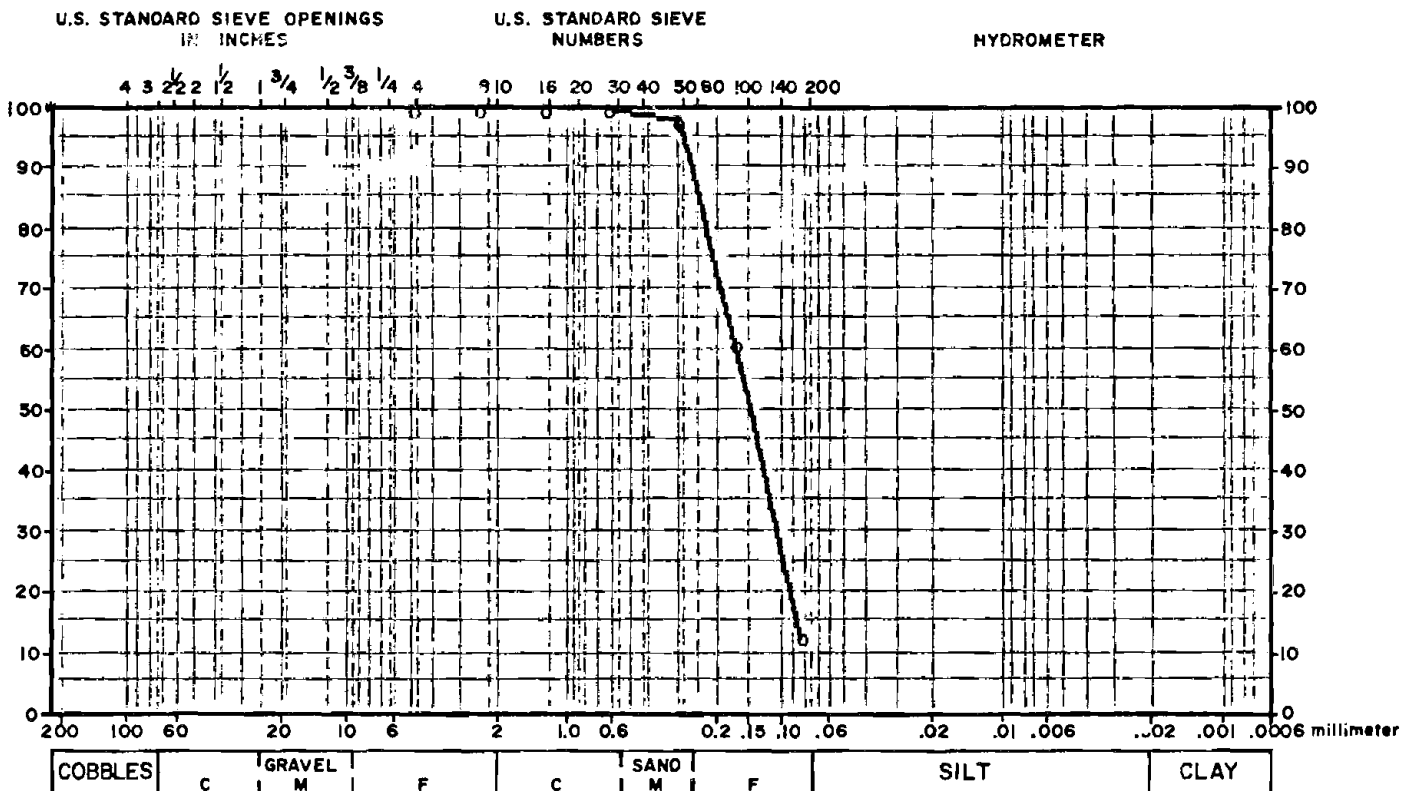

COARSE				FINE				HYDROMETER		
SIZE (inches)	PERCENT RETAINED	CUMULATIVE PERCENT PASSING	SPECS.	SIEVE	PERCENT RETAINED	CUMULATIVE PERCENT PASSING	SPECS.	PARTICLE DIAMETER (mm)	PERCENT PASSING	SPECS.
-	0.00	0.00	-	4	0.00	100.00	-	-	-	-
-	0.00	0.00	-	8	0.00	100.00	-	-	-	-
-	0.00	0.00	-	16	0.00	100.00	-	-	-	-
-	0.00	0.00	-	30	0.20	99.80	-	-	-	-
-	0.00	0.00	-	50	1.94	97.86	-	-	-	-
-	0.00	0.00	-	100	36.53	61.33	-	-	-	-
-	0.00	0.00	-	200	48.73	12.60	-	-	-	-
-	0.00	0.00	-	-	0.00	0.00	-	-	-	-
-	0.00	0.00	-	-	0.00	0.00	-	-	-	-
-	0.00	0.00	-	-	0.00	0.00	-	-	-	-
-	0.00	0.00	-	-	0.00	0.00	-	-	-	-

PAN = 12.6%
WASH LOSS = 9.2%

SPECIFICATION: ASTM C-136 ASTM C-117

TEST STANDARD: NONE

NOTES: NONE

Test samples are retained for 30 days after submission and then discarded, unless other arrangements are made.

Dunn Geoscience Laboratory

5 Northway Lane North, Latham, NY 12110 (518) 783-8102

CLIENT: GENERAL ELECTRIC COMPANY, NOTT ST.
 LAB NUMBER: 12929 DATE RECEIVED: 7/5/84
 TEST BY: JWH DATE TESTED: 7/11/84
 REVIEWED BY: *JAT* DATE REPORTED: 7/17/84
 SAMPLE DESCR: BORING DGC 7 I, S-1, 46.0'-48.0'

GRAIN SIZE DISTRIBUTION

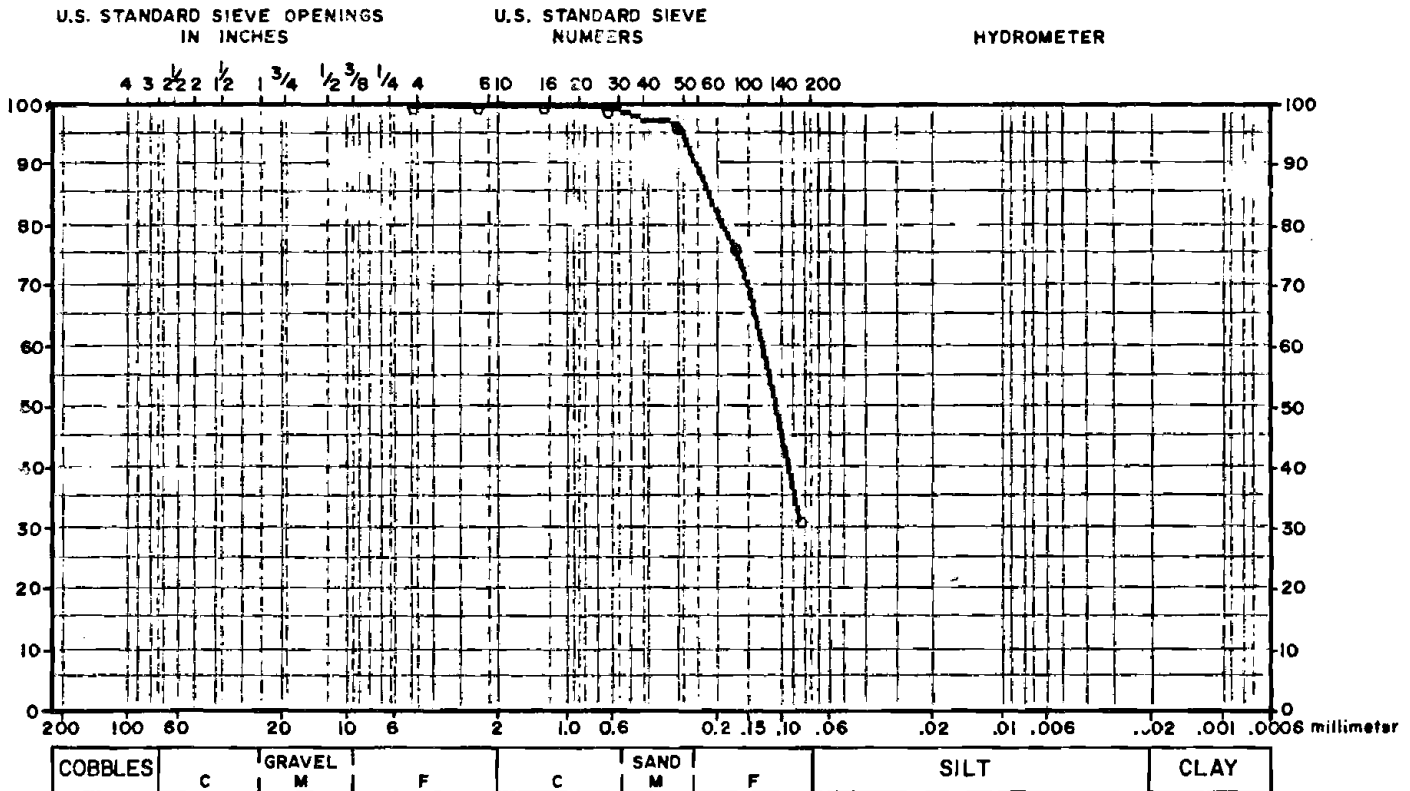

COARSE				FINE				HYDROMETER		
SIZE (inches)	PERCENT RETAINED	CUMULATIVE PERCENT PASSING	SPECS.	SIEVE	PERCENT RETAINED	CUMULATIVE PERCENT PASSING	SPECS.	PARTICLE DIAMETER (mm)	PERCENT PASSING	SPECS.
-	0.00	0.00	-	4	0.00	100.00	-			
-	0.00	0.00	-	8	0.00	100.00	-			
-	0.00	0.00	-	16	0.04	99.96	-			
-	0.00	0.00	-	30	0.35	99.61	-			
-	0.00	0.00	-	50	3.14	96.47	-			
-	0.00	0.00	-	100	19.92	76.55	-			
-	0.00	0.00	-	200	45.16	31.40	-			
-	0.00	0.00	-	-	0.00	0.00	-			
-	0.00	0.00	-	-	0.00	0.00	-			
-	0.00	0.00	-	-	0.00	0.00	-			
-	0.00	0.00	-	-	0.00	0.00	-			
-	0.00	0.00	-	-	0.00	0.00	-			

FAN = 31.4%
 WASH LOSS WAS NOT TESTED.

SPECIFICATION: ASTM C 136

TEST STANDARD: NA

NOTES: NONE

Dunn Geoscience Laboratory

5 Northway Lane North, Latham, NY 12110 (518) 783-8102

CLIENT: GENERAL ELECTRIC COMPANY, NOTT ST.
 LAB NUMBER: 12930 DATE RECEIVED: 7/5/84
 TEST BY: JWH DATE TESTED: 7/11/84
 REVIEWED BY: *[Signature]* DATE REPORTED: 7/17/84
 SAMPLE DESCR: BORING DGC 7 S S-1, 30.0'-32.0'

GRAIN SIZE DISTRIBUTION

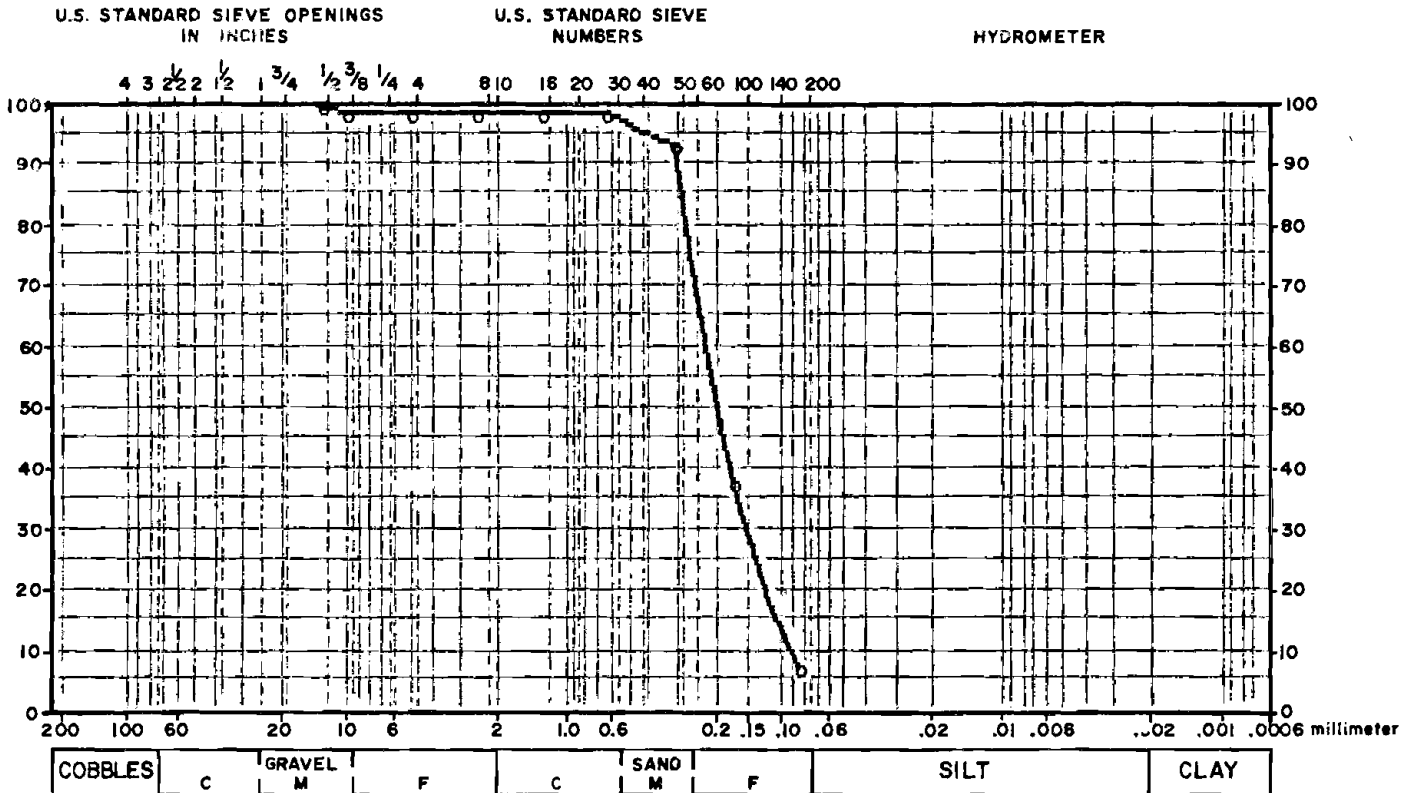

COARSE				FINE				HYDROMETER		
SIZE (inches)	PERCENT RETAINED	CUMULATIVE PERCENT PASSING	SPECS.	SIEVE	PERCENT RETAINED	CUMULATIVE PERCENT PASSING	SPECS.	PARTICLE DIAMETER (mm)	PERCENT PASSING	SPECS.
1/2	0.00	100.00	-	4	0.00	98.91	-			
3/8	1.09	98.91	-	8	.11	98.80	-			
-	0.00	0.00	-	16	.07	98.72	-			
-	0.00	0.00	-	30	.07	98.65	-			
-	0.00	0.00	-	50	5.28	93.37	-			
-	0.00	0.00	-	100	55.17	38.19	-			
-	0.00	0.00	-	200	30.90	7.29	-			
-	0.00	0.00	-	-	0.00	0.00	-			
-	0.00	0.00	-	-	0.00	0.00	-			
-	0.00	0.00	-	-	0.00	0.00	-			
-	0.00	0.00	-	-	0.00	0.00	-			
-	0.00	0.00	-	-	0.00	0.00	-			

PAN = 7.3%
 WASH LOSS WAS NOT TESTED.

SPECIFICATION: ASTM C 136
 TEST STANDARD: NA
 NOTES: NONE

Dunn Geoscience Laboratory

5 Northway Lane North, Latham, NY 12110 (518) 783-8102

CLIENT: GENERAL ELECTRIC COMPANY, NOTT ST.
 LAB NUMBER: 12931 DATE RECEIVED: 7/5/84
 TEST BY: JWH DATE TESTED: 7/12/84
 REVIEWED BY: *JWH* DATE REPORTED: 7/17/84
 SAMPLE DESCR: BORING DCC 8, S-13, 60.0'-62.0'

GRAIN SIZE DISTRIBUTION

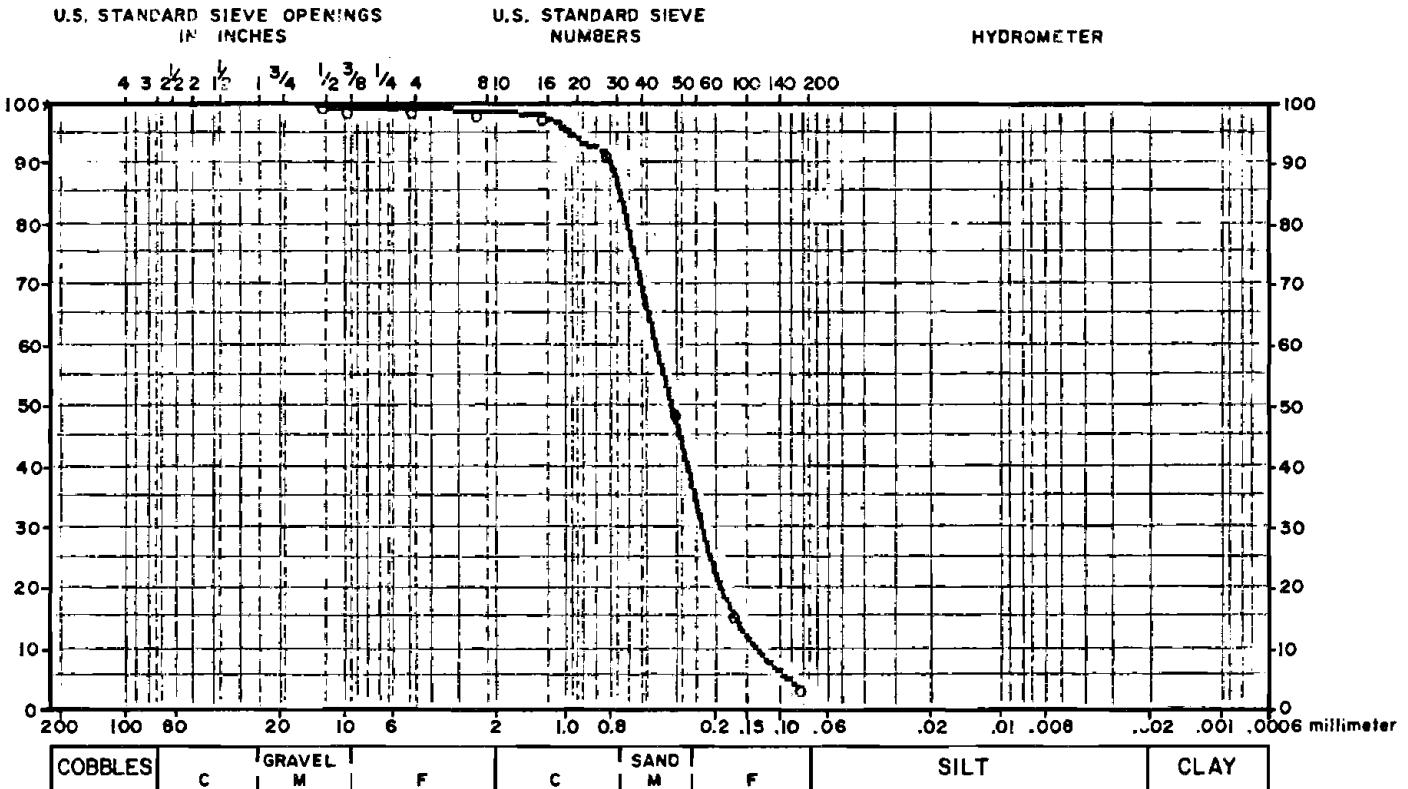

COARSE				FINE				HYDROMETER		
SIZE (inches)	PERCENT RETAINED	CUMULATIVE PERCENT PASSING	SPECS.	SIEVE	PERCENT RETAINED	CUMULATIVE PERCENT PASSING	SPECS.	PARTICLE DIAMETER (mm)	PERCENT PASSING	SPECS.
1/2	0.00	100.00	-	4	.29	99.14	-			
3/8	.58	99.42	-	8	.22	98.92	-			
-	0.00	0.00	-	16	.76	98.16	-			
-	0.00	0.00	-	30	6.37	91.79	-			
-	0.00	0.00	-	50	42.26	49.53	-			
-	0.00	0.00	-	100	33.73	15.80	-			
-	0.00	0.00	-	200	12.24	3.56	-			
-	0.00	0.00	-	-	0.00	0.00	-			
-	0.00	0.00	-	-	0.00	0.00	-			
-	0.00	0.00	-	-	0.00	0.00	-			
-	0.00	0.00	-	-	0.00	0.00	-			
-	0.00	0.00	-	-	0.00	0.00	-			

PAN = 3.6%
 WASH LOSS WAS NOT TESTED.

SPECIFICATION: ASTM C 136

TEST STANDARD: NA

NOTES: NONE

Dunn Geoscience Laboratory

5 Northway Lane North, Latham, NY 12110 (518) 783-8102

CLIENT: GENERAL ELECTRIC COMPANY, NOTT ST.
 LAB NUMBER: 12933 DATE RECEIVED: 7/5/84
 TEST BY: JWH DATE TESTED: 7/12/84
 REVIEWED BY: *led* DATE REPORTED: 7/17/84
 SAMPLE DESCR: BORING DGC 8 I, S-1, 51.0'-53.0'

GRAIN SIZE DISTRIBUTION

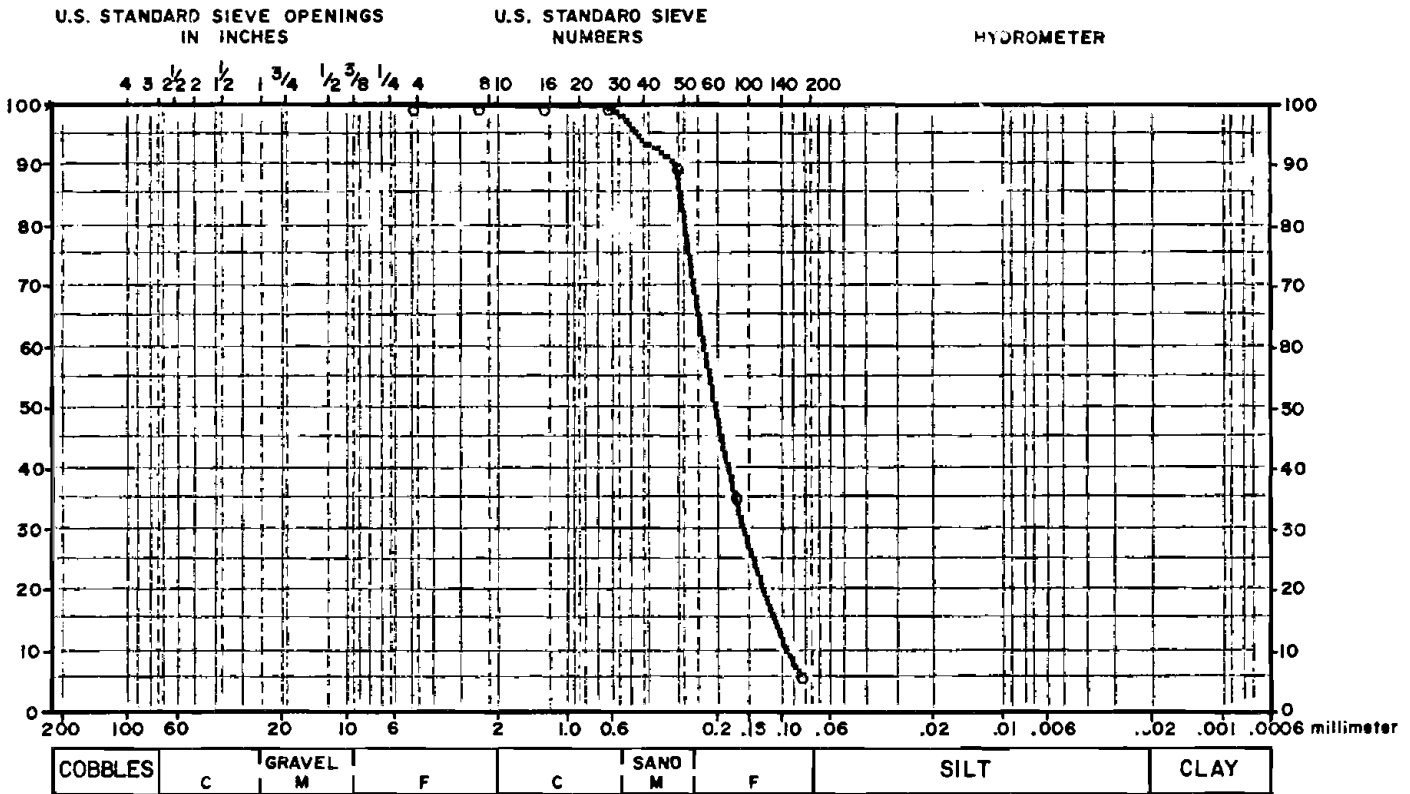

COARSE				FINE				HYDROMETER		
SIZE (inches)	PERCENT RETAINED	CUMULATIVE PERCENT PASSING	SPECS.	SIEVE	PERCENT RETAINED	CUMULATIVE PERCENT PASSING	SPECS.	PARTICLE DIAMETER (mm)	PERCENT PASSING	SPECS.
-	0.00	0.00	-	4	0.00	100.00	-			
-	0.00	0.00	-	8	0.00	100.00	-			
-	0.00	0.00	-	16	0.00	100.00	-			
-	0.00	0.00	-	30	.24	99.76	-			
-	0.00	0.00	-	50	10.03	89.74	-			
-	0.00	0.00	-	100	53.67	36.06	-			
-	0.00	0.00	-	200	30.04	6.03	-			
-	0.00	0.00	-	-	0.00	0.00	-			
-	0.00	0.00	-	-	0.00	0.00	-			
-	0.00	0.00	-	-	0.00	0.00	-			
-	0.00	0.00	-	-	0.00	0.00	-			

PAN = 6.0%
 WASH LOSS WAS NOT TESTED.

SPECIFICATION: ASTM C 136
 TEST STANDARD: NA
 NOTES: NONE

Dunn Geoscience Laboratory

5 Northway Lane North, Latham, NY 12110 (518) 783-8102

CLIENT: GENERAL ELECTRIC COMPANY, NOTT ST.
 LAB NUMBER: 12934 DATE RECEIVED: 7/5/84
 TEST BY: JWH DATE TESTED: 7/12/84
 REVIEWED BY: *[Signature]* DATE REPORTED: 7/17/84
 SAMPLE DESCR: BORING DGC 8 S, S-1, 32.0'-34.0'

GRAIN SIZE DISTRIBUTION

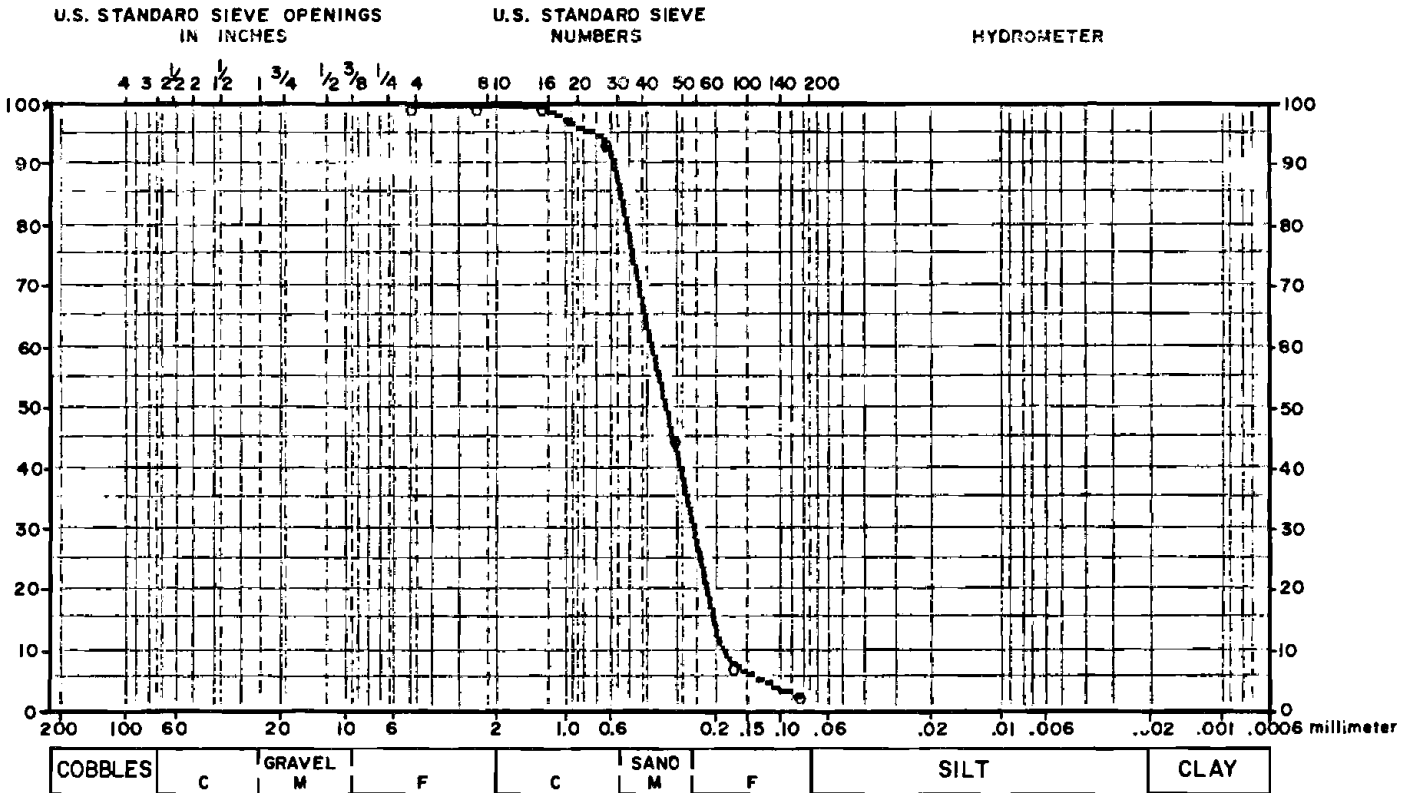

COARSE				FINE				HYDROMETER		
SIZE (inches)	PERCENT RETAINED	CUMULATIVE PERCENT PASSING	SPECS.	SIEVE	PERCENT RETAINED	CUMULATIVE PERCENT PASSING	SPECS.	PARTICLE DIAMETER (mm)	PERCENT PASSING	SPECS.
-	0.00	0.00	-	4	0.00	100.00	-			
-	0.00	0.00	-	8	0.00	100.00	-			
-	0.00	0.00	-	16	.33	99.67	-			
-	0.00	0.00	-	30	5.72	93.95	-			
-	0.00	0.00	-	50	48.68	45.27	-			
-	0.00	0.00	-	100	37.23	8.04	-			
-	0.00	0.00	-	200	5.30	2.74	-			
-	0.00	0.00	-	-	0.00	0.00	-			
-	0.00	0.00	-	-	0.00	0.00	-			
-	0.00	0.00	-	-	0.00	0.00	-			
-	0.00	0.00	-	-	0.00	0.00	-			

PAN = 2.7%
WASH LOSS WAS NOT TESTED.

SPECIFICATION: ASTM C 136

TEST STANDARD: NA

NOTES: NONE

Dunn Geoscience Laboratory

5 Northway Lane North, Latham, NY 12110 (518) 783-8102

CLIENT: GENERAL ELECTRIC COMPANY, NOTT ST.
 LAB NUMBER: 12935 DATE RECEIVED: 7/5/84
 TEST BY: JWH DATE TESTED: 7/12/84
 REVIEWED BY: *feh* DATE REPORTED: 7/17/84
 SAMPLE DESCR: BORING DGC 9, S-13, 60.0'-62.0'

GRAIN SIZE DISTRIBUTION

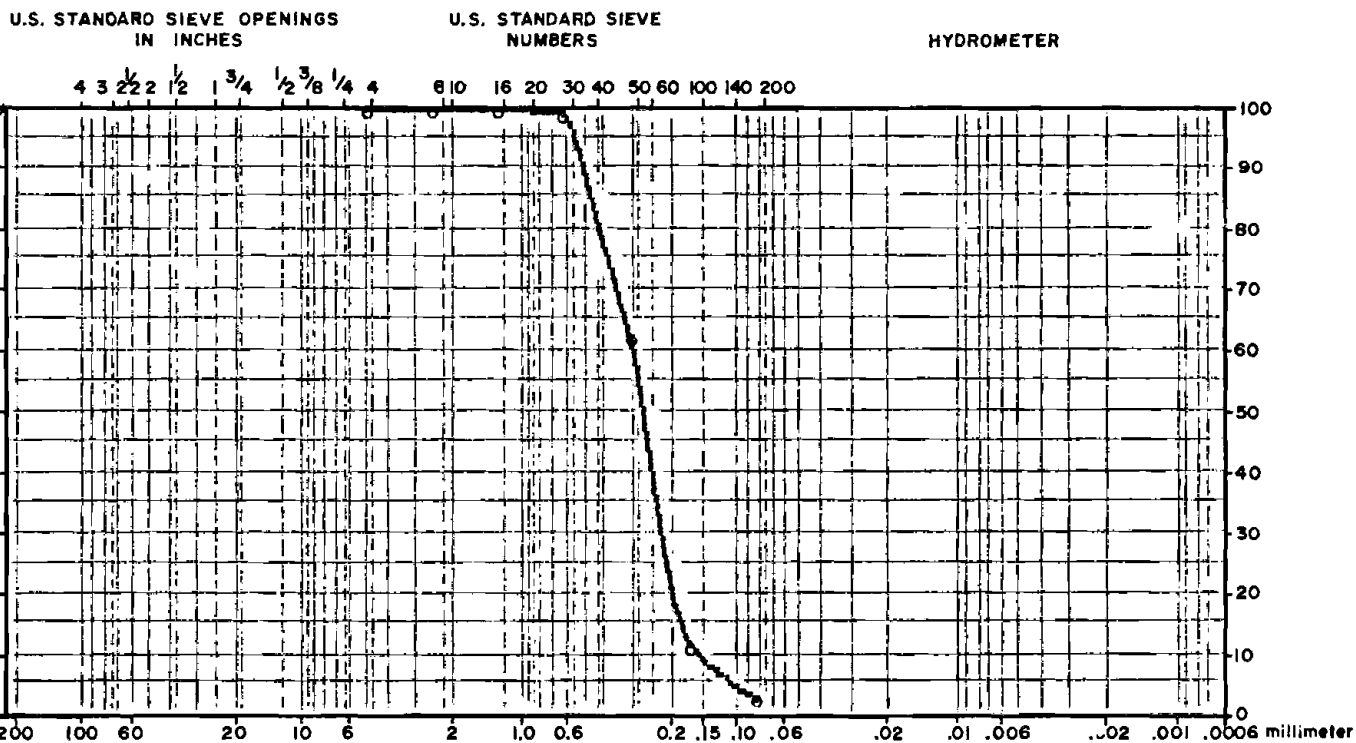

COBBLES	GRAVEL	SAND	SILT	CLAY
C	M	F		

COARSE

SIZE (Inches)	PERCENT RETAINED	CUMULATIVE PERCENT PASSING	SPECS.
-	0.00	0.00	-
-	0.00	0.00	-
-	0.00	0.00	-
-	0.00	0.00	-
-	0.00	0.00	-
-	0.00	0.00	-
-	0.00	0.00	-
-	0.00	0.00	-
-	0.00	0.00	-
-	0.00	0.00	-
-	0.00	0.00	-
-	0.00	0.00	-
-	0.00	0.00	-
-	0.00	0.00	-
-	0.00	0.00	-
-	0.00	0.00	-

FINE

SIEVE	PERCENT RETAINED	CUMULATIVE PERCENT PASSING	SPECS.
4	0.00	100.00	-
8	0.00	100.00	-
16	.03	99.97	-
30	.55	99.42	-
50	36.51	62.92	-
100	50.60	12.31	-
200	9.46	2.85	-
-	0.00	0.00	-
-	0.00	0.00	-
-	0.00	0.00	-
-	0.00	0.00	-
-	0.00	0.00	-
-	0.00	0.00	-
-	0.00	0.00	-

HYDROMETER

PARTICLE DIAMETER (mm)	PERCENT PASSING	SPECS.
-	-	-

PAN = 2.9%

WASH LOSS WAS NOT TESTED.

SPECIFICATION: ASTM C 136

TEST STANDARD: NA

NOTES: NONE

Dunn Geoscience Laboratory

5 Northway Lane North, Latham, NY 12110 (518) 783-8102

CLIENT: GENERAL ELECTRIC COMPANY NOTT STREET
 LAB NUMBER: 12936 DATE RECEIVED: 7/5/84
 TEST BY: JWH DATE TESTED: 7/17/84
 REVIEWED BY: *MJZ* DATE REPORTED: 7/24/84
 SAMPLE DESCR: BORING DGC-9 S-16 75.0' - 77.0'

GRAIN SIZE DISTRIBUTION

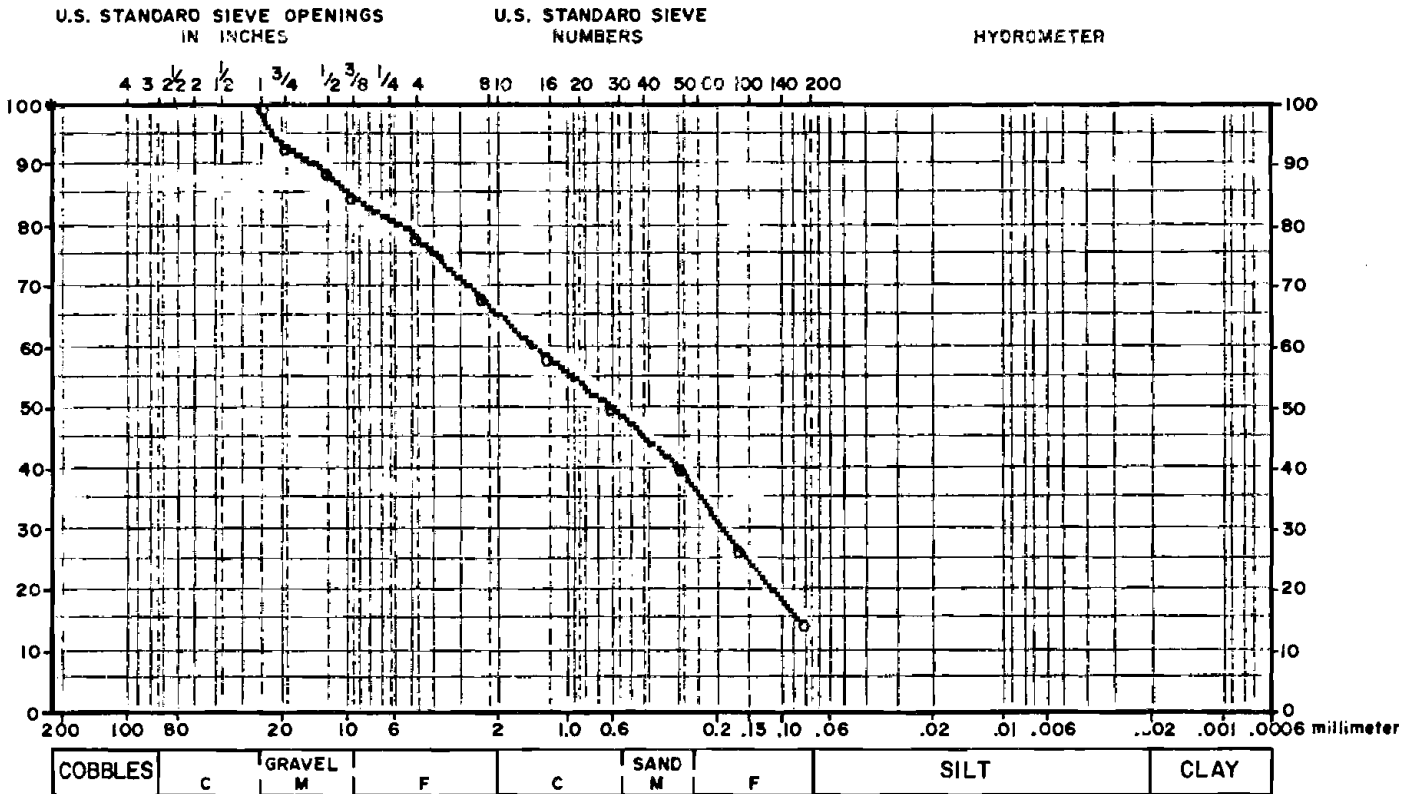

COBBLES	C	GRAVEL	M	F	C	SAND	M	F	SILT	CLAY
---------	---	--------	---	---	---	------	---	---	------	------

COARSE			
SIZE (Inches)	PERCENT RETAINED	CUMULATIVE PERCENT PASSING	SPECS.
1	0.00	100.00	-
3/4	6.84	93.16	-
1/2	3.88	89.28	-
3/8	3.97	85.32	-
-	0.00	0.00	-
-	0.00	0.00	-
-	0.00	0.00	-
-	0.00	0.00	-
-	0.00	0.00	-
-	0.00	0.00	-
-	0.00	0.00	-
-	0.00	0.00	-

FINE			
SIEVE	PERCENT RETAINED	CUMULATIVE PERCENT PASSING	SPECS.
4	6.79	78.52	-
8	10.04	68.48	-
16	9.62	58.86	-
30	8.52	50.34	-
50	9.92	40.42	-
100	13.00	27.43	-
200	12.53	14.89	-
-	0.00	0.00	-
-	0.00	0.00	-
-	0.00	0.00	-
-	0.00	0.00	-
-	0.00	0.00	-

HYDROMETER		
PARTICLE DIAMETER (mm)	PERCENT PASSING	SPECS.
-	-	-
-	-	-
-	-	-
-	-	-
-	-	-

PAN = 14.9%
 WASH LOSS = 11.8%

SPECIFICATION: ASTM C-136 ASTM C-117
 TEST STANDARD: NONE
 NOTES: NONE

Test samples are retained for 30 days after submission and then discarded, unless other arrangements are made.

Dunn Geoscience Laboratory

5 Northway Lane North, Latham, NY 12110 (518) 783-8102

CLIENT: GENERAL ELECTRIC COMPANY, NOTT ST.
 LAB NUMBER: 12937 DATE RECEIVED: 7/5/84
 TEST BY: JWH DATE TESTED: 7/12/84
 REVIEWED BY: *Ad* DATE REPORTED: 7/17/84
 SAMPLE DESCR: BORING DGC 9 I, S-1, 36.0'-38.0'

GRAIN SIZE DISTRIBUTION

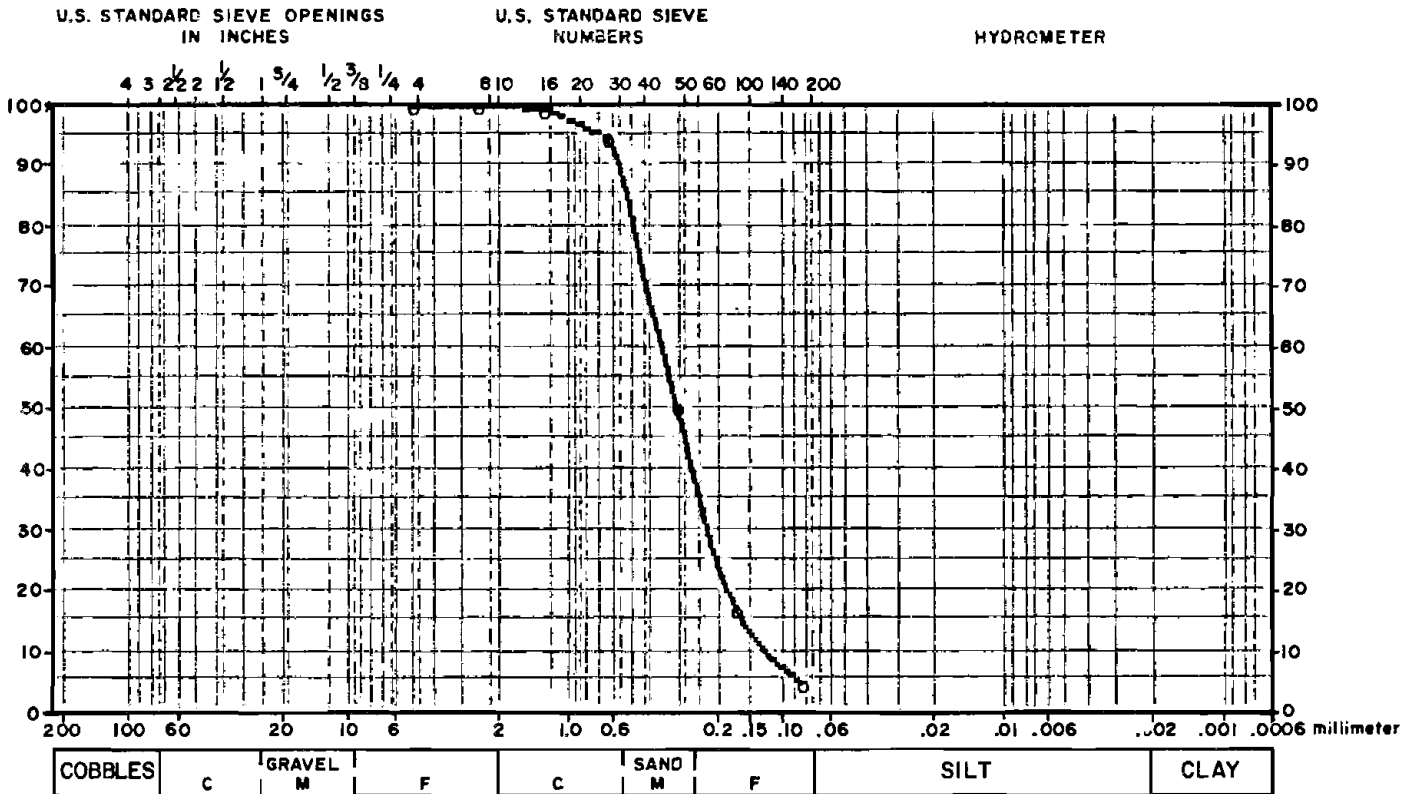

COARSE			
SIZE (Inches)	PERCENT RETAINED	CUMULATIVE PERCENT PASSING	SPECS.
-	0.00	0.00	-
-	0.00	0.00	-
-	0.00	0.00	-
-	0.00	0.00	-
-	0.00	0.00	-
-	0.00	0.00	-
-	0.00	0.00	-
-	0.00	0.00	-
-	0.00	0.00	-
-	0.00	0.00	-
-	0.00	0.00	-
-	0.00	0.00	-
-	0.00	0.00	-
-	0.00	0.00	-
-	0.00	0.00	-

FINE			
SIEVE	PERCENT RETAINED	CUMULATIVE PERCENT PASSING	SPECS.
4	0.00	100.00	-
8	0.00	100.00	-
16	.43	99.57	-
30	5.10	94.47	-
50	43.59	50.88	-
100	33.88	17.01	-
200	12.04	4.96	-
-	0.00	0.00	-
-	0.00	0.00	-
-	0.00	0.00	-
-	0.00	0.00	-
-	0.00	0.00	-
-	0.00	0.00	-

HYDROMETER		
PARTICLE DIAMETER (mm)	PERCENT PASSING	SPECS.
-	-	-
-	-	-
-	-	-
-	-	-
-	-	-
-	-	-
-	-	-
-	-	-
-	-	-
-	-	-
-	-	-
-	-	-
-	-	-
-	-	-
-	-	-

PAN = 5.0%
 WASH LOSS WAS NOT TESTED.

SPECIFICATION: ASTM C 136
 TEST STANDARD: NA
 NOTES: NONE

Dunn Geoscience Laboratory

5 Northway Lane North, Latham, NY 12110 (518) 783-8102

CLIENT: GENERAL ELECTRIC COMPANY, NOTT ST.
 LAB NUMBER: 12938 DATE RECEIVED: 7/5/84
 TEST BY: JWA DATE TESTED: 7/12/84
 REVIEWED BY: *[Signature]* DATE REPORTED: 7/17/84
 SAMPLE DESCR: BORING DGC 9 S, S-1, 33.0'-35.0'

GRAIN SIZE DISTRIBUTION

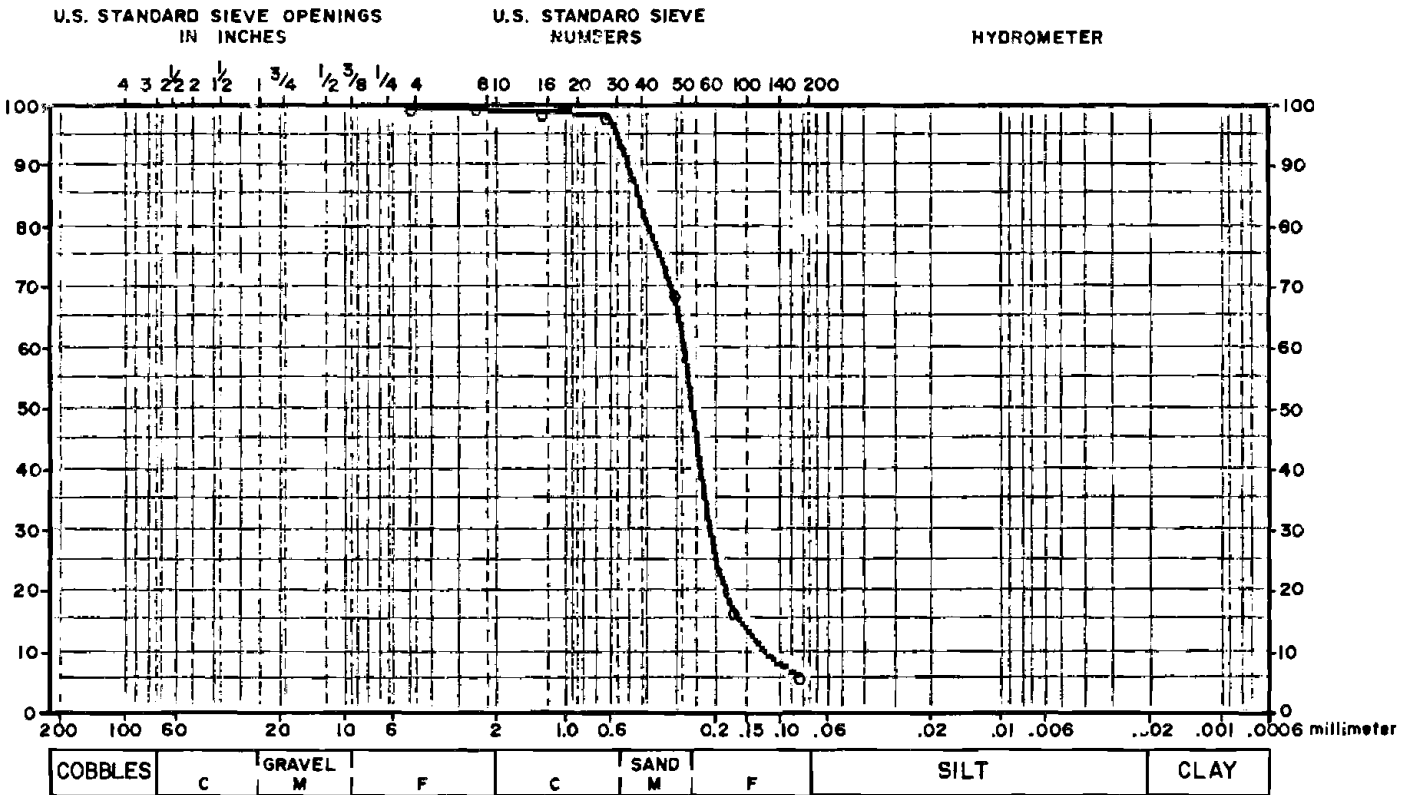

COARSE				FINE				HYDROMETER		
SIZE (Inches)	PERCENT RETAINED	CUMULATIVE PERCENT PASSING	SPECS.	SIEVE	PERCENT RETAINED	CUMULATIVE PERCENT PASSING	SPECS.	PARTICLE DIAMETER (mm)	PERCENT PASSING	SPECS.
-	0.00	0.00	-	4	.22	99.78	-			
-	0.00	0.00	-	8	.09	99.69	-			
-	0.00	0.00	-	16	.22	99.47	-			
-	0.00	0.00	-	30	.89	98.58	-			
-	0.00	0.00	-	50	29.31	69.26	-			
-	0.00	0.00	-	100	52.05	17.22	-			
-	0.00	0.00	-	200	11.48	5.74	-			
-	0.00	0.00	-	-	0.00	0.00	-			
-	0.00	0.00	-	-	0.00	0.00	-			
-	0.00	0.00	-	-	0.00	0.00	-			
-	0.00	0.00	-	-	0.00	0.00	-			
-	0.00	0.00	-	-	0.00	0.00	-			

PAN = 5.7%
 WASH LOSS WAS NOT TESTED.

SPECIFICATION: ASTM C 136

TEST STANDARD: NA

NOTES: NONE

Dunn Geoscience Laboratory

5 Northway Lane North, Latham, NY 12110 (518) 783-8102

CLIENT:	GENERAL ELECTRIC COMPANY	NOTT STREET
LAB NUMBER:	12939	DATE RECEIVED: 7/5/84
TEST BY:	JWH	DATE TESTED: 7/18/84
REVIEWED BY:	<i>MJZ</i>	DATE REPORTED: 7/25/84
SAMPLE DESCR:	BORING DGC-10	S-12 55.0' - 57.0'

GRAIN SIZE DISTRIBUTION

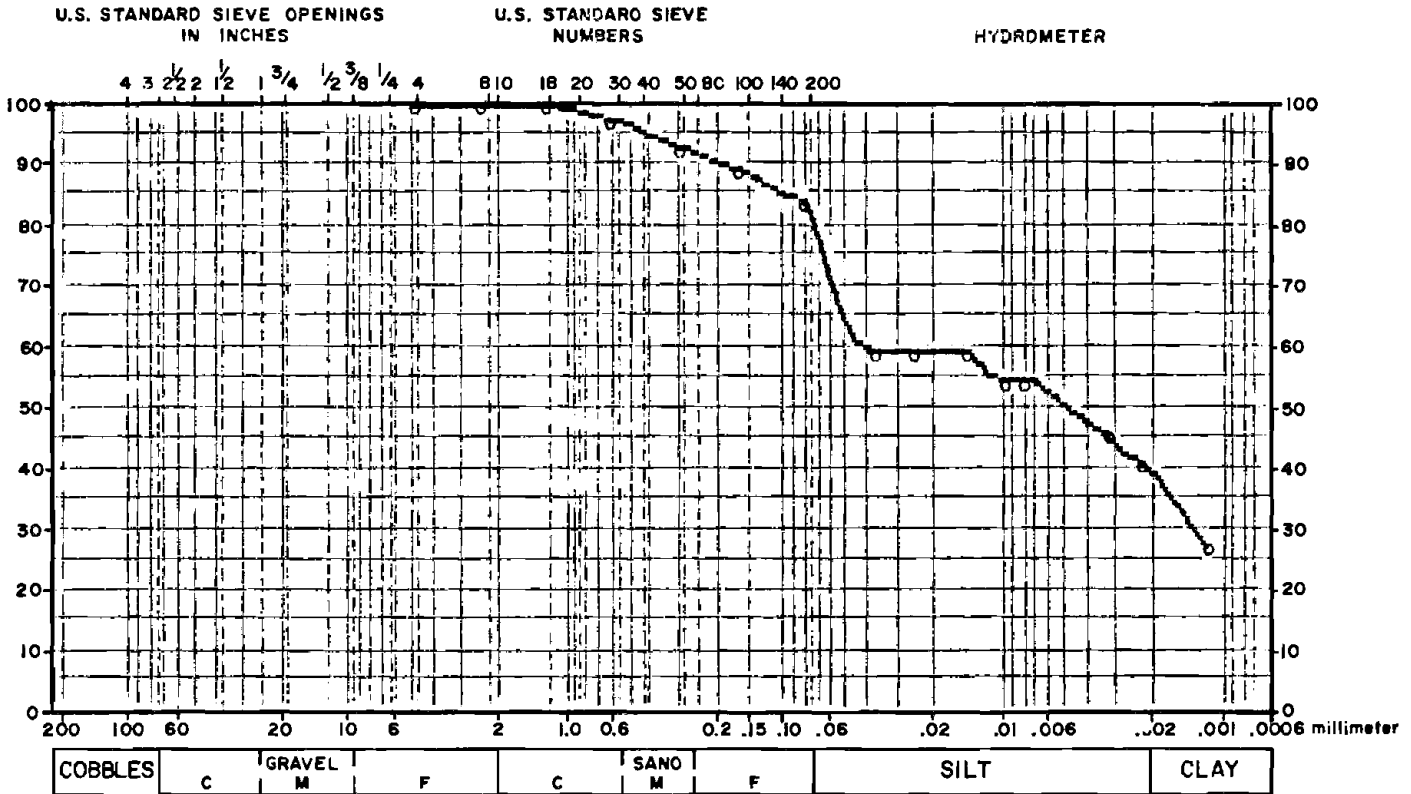

COARSE				FINE				HYDROMETER		
SIZE (inches)	PERCENT RETAINED	CUMULATIVE PERCENT PASSING	SPECS.	SIEVE	PERCENT RETAINED	CUMULATIVE PERCENT PASSING	SPECS.	PARTICLE DIAMETER (mm)	PERCENT PASSING	SPECS.
-	0.00	0.00	-	4	0.00	100.00	-	.036	59.39	-
-	0.00	0.00	-	8	0.00	100.00	-	.023	59.39	-
-	0.00	0.00	-	16	0.00	100.00	-	.013	59.39	-
-	0.00	0.00	-	30	2.38	97.62	-	.009	54.83	-
-	0.00	0.00	-	50	4.63	92.99	-	.007	54.83	-
-	0.00	0.00	-	100	3.84	89.15	-	.003	45.69	-
-	0.00	0.00	-	200	5.29	83.86	-	.002	41.12	-
-	0.00	0.00	-	-	0.00	0.00	-	.001	27.41	-

PAN = 83.9%
WASH LOSS WAS NOT TESTED.

SPECIFICATION: ASTM C-136 ASTM D-422

TEST STANDARD: NONE

NOTES: NONE

Test samples are retained for 30 days after submission and then discarded, unless other arrangements are made.

Dunn Geoscience Laboratory

5 Northway Lane North, Latham, NY 12110 (518) 783-8102

CLIENT: GENERAL ELECTRIC COMPANY, NOTT ST.
 LAB NUMBER: 12940 DATE RECEIVED: 7/5/84
 TEST BY: JWH DATE TESTED: 7/12/84
 REVIEWED BY: *[Signature]* DATE REPORTED: 7/17/84
 SAMPLE DESCR: BORING DGC 10 I, S-1, 34.0'-36.0'

GRAIN SIZE DISTRIBUTION

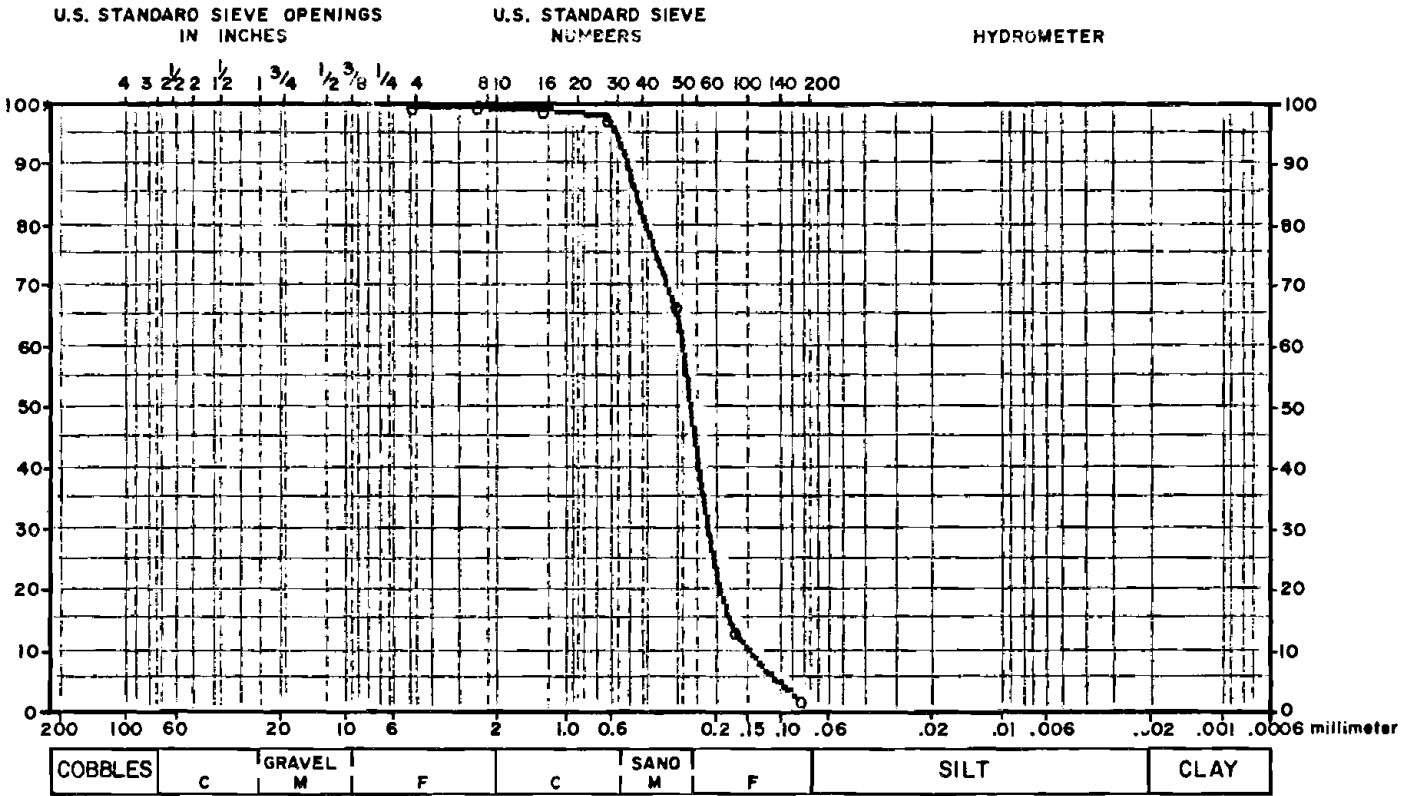

COARSE				FINE				HYDROMETER		
SIZE (inches)	PERCENT RETAINED	CUMULATIVE PERCENT PASSING	SPECS.	SIEVE	PERCENT RETAINED	CUMULATIVE PERCENT PASSING	SPECS.	PARTICLE DIAMETER (mm)	PERCENT PASSING	SPECS.
-	0.00	0.00	-	4	0.00	100.00	-			
-	0.00	0.00	-	8	.23	99.77	-			
-	0.00	0.00	-	16	.46	99.31	-			
-	0.00	0.00	-	30	1.43	97.89	-			
-	0.00	0.00	-	50	30.50	67.39	-			
-	0.00	0.00	-	100	53.34	14.05	-			
-	0.00	0.00	-	200	11.88	2.17	-			
-	0.00	0.00	-	-	0.00	0.00	-			
-	0.00	0.00	-	-	0.00	0.00	-			
-	0.00	0.00	-	-	0.00	0.00	-			
-	0.00	0.00	-	-	0.00	0.00	-			

PAN = 2.2%
 WASH LOSS WAS NOT TESTED.

SPECIFICATION: ASTM C 136

TEST STANDARD: NA

NOTES: NONE

Dunn Geoscience Laboratory

5 Northway Lane North, Latham, NY 12110 (518) 783-8102

CLIENT: GENERAL ELECTRIC COMPANY NOTT STREET
 LAB NUMBER: 12941 DATE RECEIVED: 7/5/84
 TEST BY: JWH DATE TESTED: 7/17/84
 REVIEWED BY: *MJZ* DATE REPORTED: 7/24/84
 SAMPLE DESCR: BORING DGC-10S S-1 26.0' - 28.0'

GRAIN SIZE DISTRIBUTION

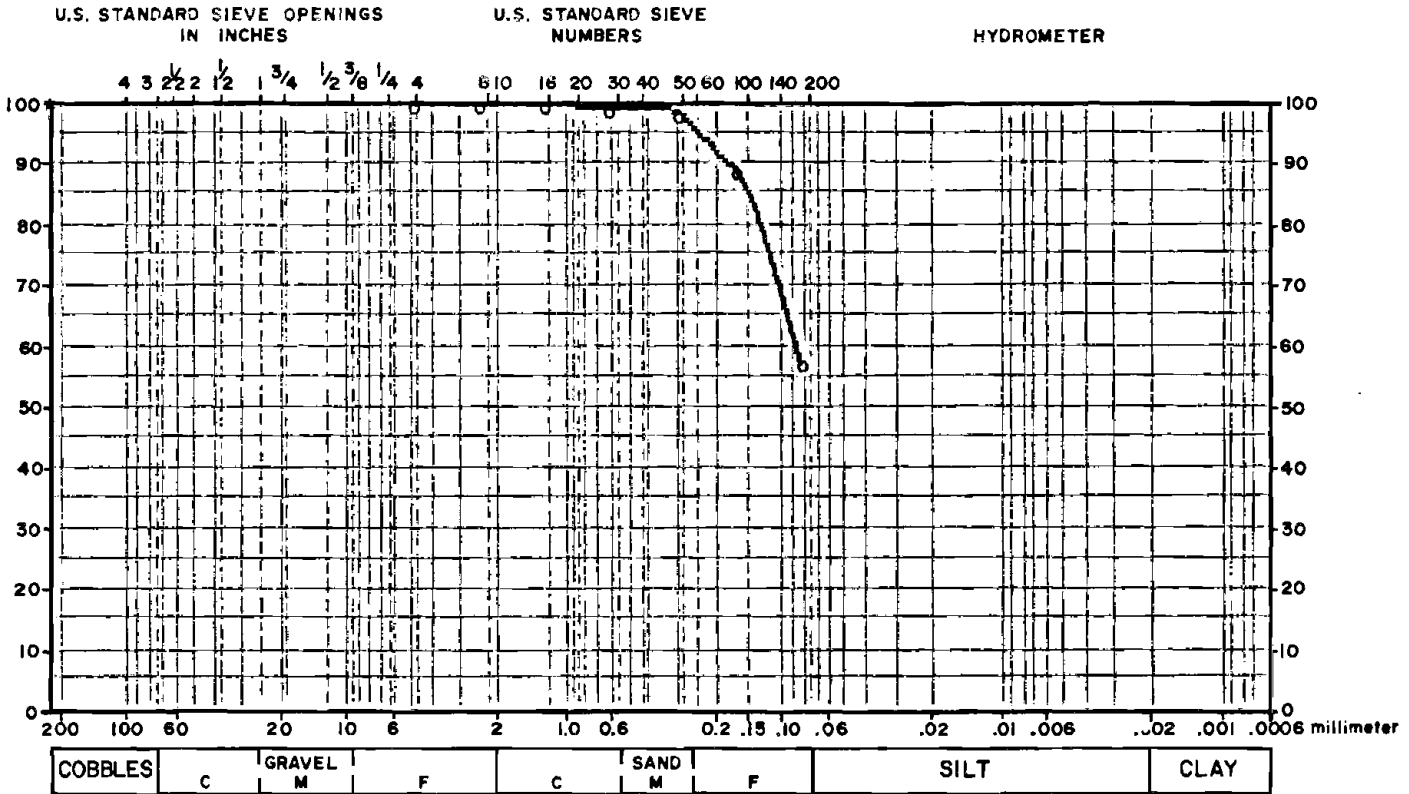

COARSE				FINE				HYDROMETER		
SIZE (inches)	PERCENT RETAINED	CUMULATIVE PERCENT PASSING	SPECS.	SIEVE	PERCENT RETAINED	CUMULATIVE PERCENT PASSING	SPECS.	PARTICLE DIAMETER (mm)	PERCENT PASSING	SPECS.
-	0.00	0.00	-	4	0.00	100.00	-			
-	0.00	0.00	-	8	0.00	100.00	-			
-	0.00	0.00	-	16	.21	99.79	-			
-	0.00	0.00	-	30	.21	99.58	-			
-	0.00	0.00	-	50	.63	98.95	-			
-	0.00	0.00	-	100	9.79	89.16	-			
-	0.00	0.00	-	200	31.89	57.27	-			
-	0.00	0.00	-	-	0.00	0.00	-			
-	0.00	0.00	-	-	0.00	0.00	-			
-	0.00	0.00	-	-	0.00	0.00	-			
-	0.00	0.00	-	-	0.00	0.00	-			
-	0.00	0.00	-	-	0.00	0.00	-			

PAN = 57.3%
 WASH LOSS = 52.0%

SPECIFICATION: ASTM C-136 ASTM C-117

TEST STANDARD: NONE

NOTES: NONE

Test samples are retained for 30 days after submission

Dunn Geoscience Laboratory

5 Northway Lane North, Latham, NY 12110 (518) 783-8102

CLIENT:	GENERAL ELECTRIC COMPANY	NOTT STREET
LAB NUMBER:	12942	DATE RECEIVED: 7/5/84
TEST BY:	JWH	DATE TESTED: 7/18/84
REVIEWED BY:	<i>MJZ</i>	DATE REPORTED: 7/25/84
SAMPLE DESCR:	BORING DGC-11	S-35 68.0' - 70.0'

GRAIN SIZE DISTRIBUTION

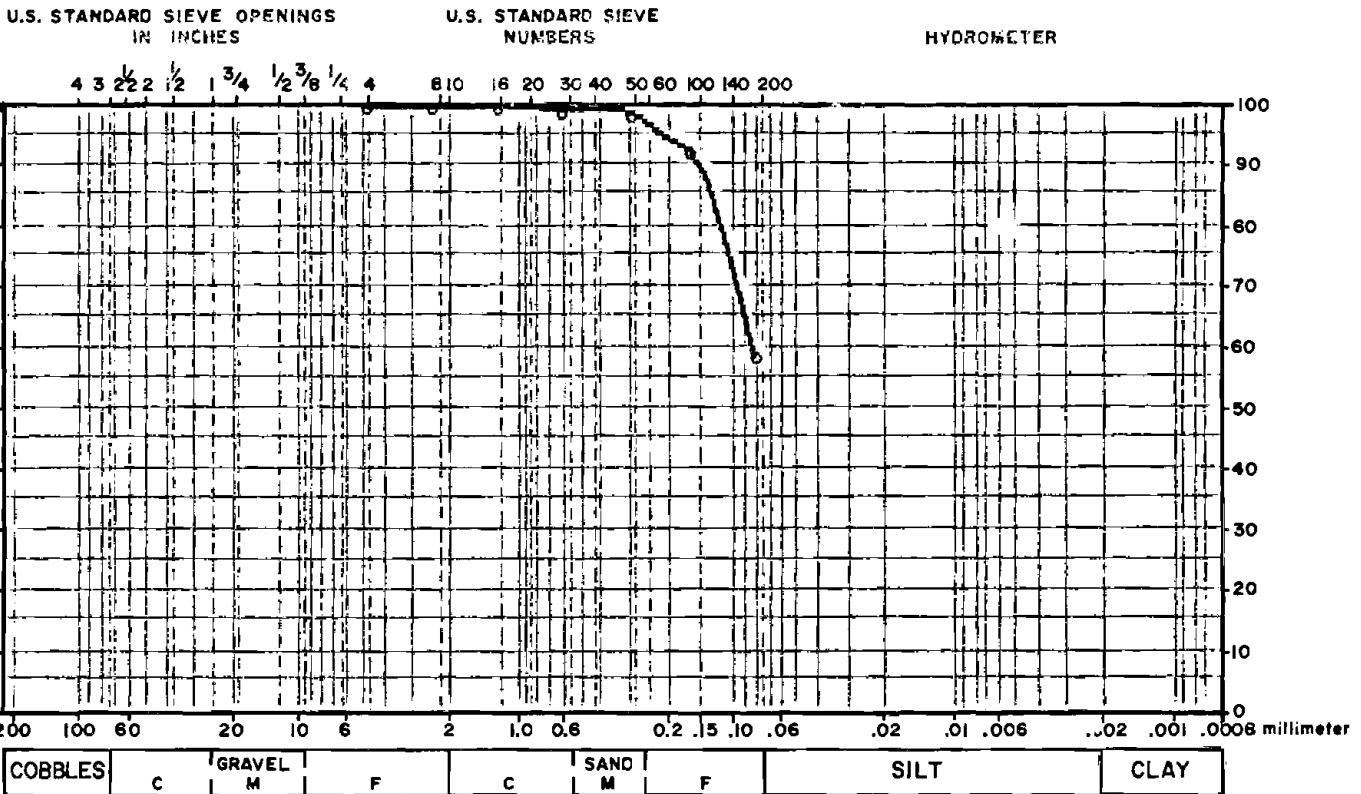

COARSE				FINE				HYDROMETER		
SIZE (Inches)	PERCENT RETAINED	CUMULATIVE PERCENT PASSING	SPECS.	SIEVE	PERCENT RETAINED	CUMULATIVE PERCENT PASSING	SPECS.	PARTICLE DIAMETER (mm)	PERCENT PASSING	SPECS.
-	0.00	0.00	-	4	0.00	100.00	-			
-	0.00	0.00	-	8	0.00	100.00	-			
-	0.00	0.00	-	16	.07	99.93	-			
-	0.00	0.00	-	30	.42	99.52	-			
-	0.00	0.00	-	50	.62	98.89	-			
-	0.00	0.00	-	100	6.37	92.53	-			
-	0.00	0.00	-	200	33.77	58.75	-			
-	0.00	0.00	-	-	0.00	0.00	-			
-	0.00	0.00	-	-	0.00	0.00	-			
-	0.00	0.00	-	-	0.00	0.00	-			
-	0.00	0.00	-	-	0.00	0.00	-			
-	0.00	0.00	-	-	0.00	0.00	-			
-	0.00	0.00	-	-	0.00	0.00	-			
-	0.00	0.00	-	-	0.00	0.00	-			

PAN = 58.8%
WASH LOSS = 47.1%

SPECIFICATION: ASTM C-136 ASTM C-117

TEST STANDARD: NONE

NOTES: NONE

Test samples are retained for 30 days after submission

Dunn Geoscience Laboratory

5 Northway Lane North, Latham, NY 12110 (518) 783-8102

CLIENT: GENERAL ELECTRIC COMPANY NOTT STREET
 LAB NUMBER: 12943 DATE RECEIVED: 7/5/84
 TEST BY: JWH DATE TESTED: 7/17/84
 REVIEWED BY: *MJZ* DATE REPORTED: 7/24/84
 SAMPLE DESCR: BORING DGC-11 S-45 88.0' - 90.0'

GRAIN SIZE DISTRIBUTION

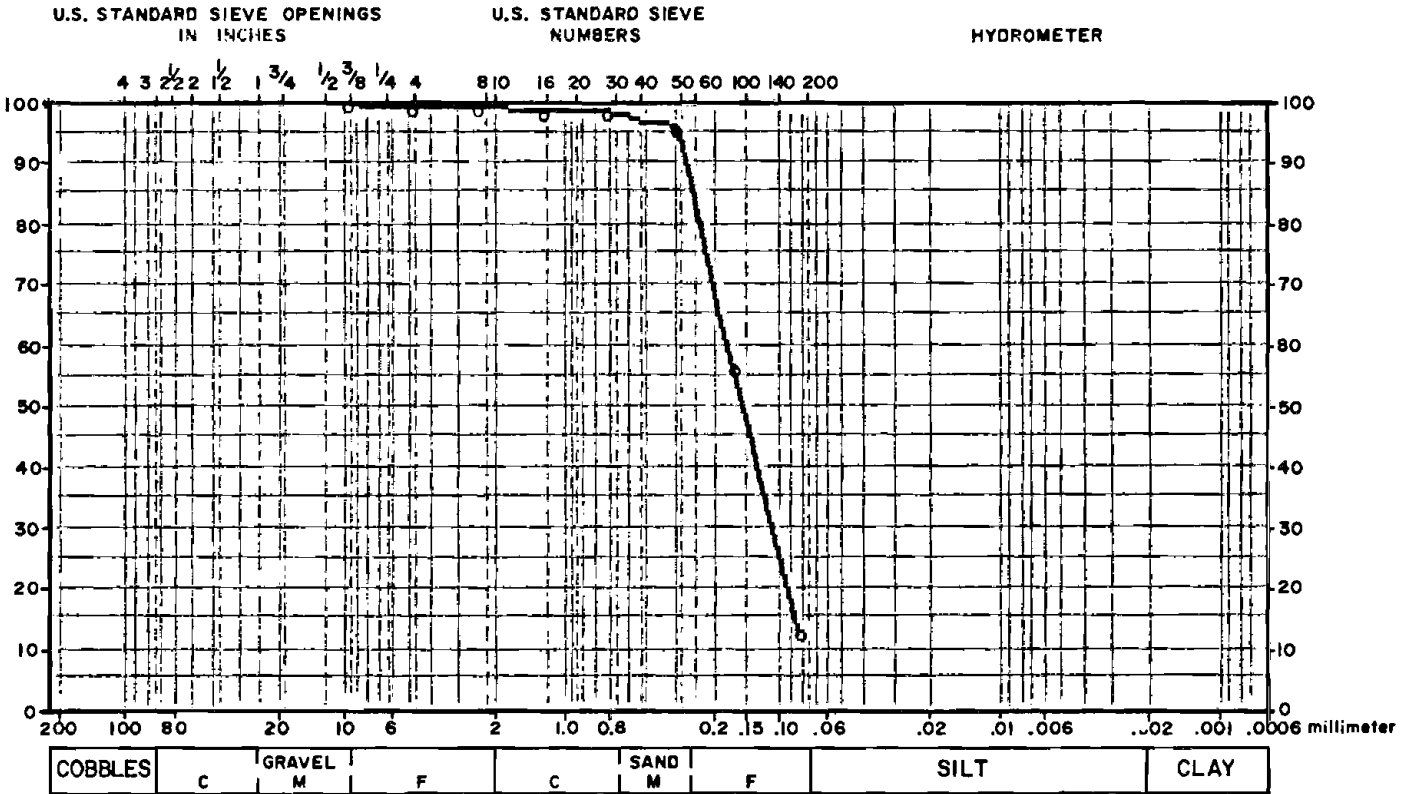

COARSE				FINE				HYDROMETER		
SIZE (Inches)	PERCENT RETAINED	CUMULATIVE PERCENT PASSING	SPECS.	SIEVE	PERCENT RETAINED	CUMULATIVE PERCENT PASSING	SPECS.	PARTICLE DIAMETER (mm)	PERCENT PASSING	SPECS.
3/8	0.00	100.00	-	4	.77	99.23	-			
-	0.00	0.00	-	8	.15	99.07	-			
-	0.00	0.00	-	16	.15	98.92	-			
-	0.00	0.00	-	30	.35	98.57	-			
-	0.00	0.00	-	50	2.44	96.13	-			
-	0.00	0.00	-	100	39.56	56.57	-			
-	0.00	0.00	-	200	43.70	12.88	-			
-	0.00	0.00	-	-	0.00	0.00	-			
-	0.00	0.00	-	-	0.00	0.00	-			
-	0.00	0.00	-	-	0.00	0.00	-			
-	0.00	0.00	-	-	0.00	0.00	-			
-	0.00	0.00	-	-	0.00	0.00	-			

PAN = 12.9%
 WASH LOSS = 8.7%

SPECIFICATION: ASTM C-136 ASTM C-117

TEST STANDARD: NONE

NOTES: NONE

Test samples are retained for 30 days after submission and then discarded, unless other arrangements are made.

Dunn Geoscience Laboratory

5 Northway Lane North, Latham, NY 12110 (518) 783-8102

CLIENT: GENERAL ELECTRIC COMPANY, NOTT ST.
 LAB NUMBER: 12944 DATE RECEIVED: 7/5/84
 TEST BY: JWH DATE TESTED: 7/16/84
 REVIEWED BY: *fact* DATE REPORTED: 7/17/84
 SAMPLE DESCR: BORING DGC 11 I, S-1, 46.0'-48.0'

GRAIN SIZE DISTRIBUTION

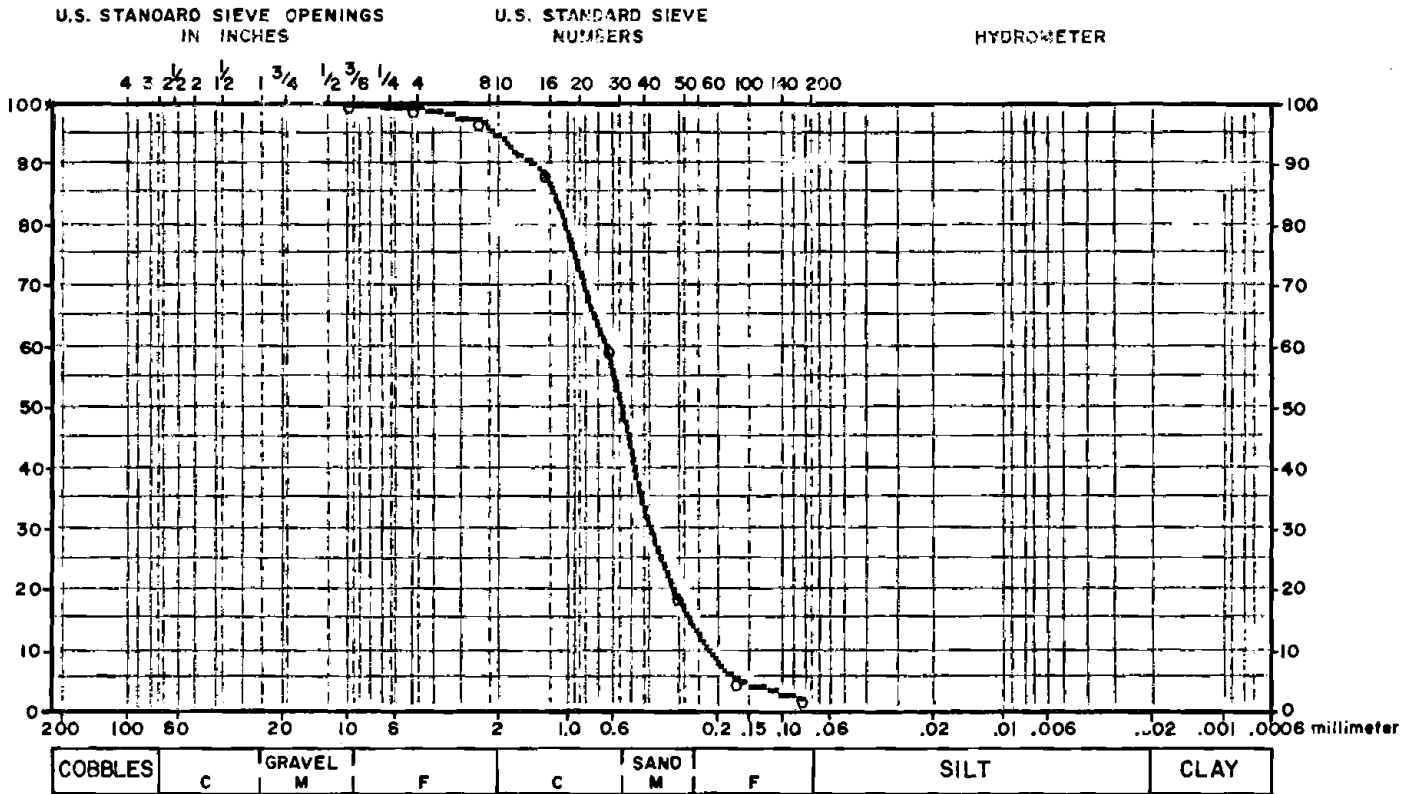

COARSE				FINE				HYDROMETER		
SIZE (Inches)	PERCENT RETAINED	CUMULATIVE PERCENT PASSING	SPECS.	SIEVE	PERCENT RETAINED	CUMULATIVE PERCENT PASSING	SPECS.	PARTICLE DIAMETER (mm)	PERCENT PASSING	SPECS.
3/8	0.00	100.00	-	4	5.8	99.42	-			
-	0.00	0.00	-	8	2.28	97.14	-			
-	0.00	0.00	-	16	8.42	88.72	-			
-	0.00	0.00	-	30	29.03	59.69	-			
-	0.00	0.00	-	50	40.24	19.45	-			
-	0.00	0.00	-	100	13.94	5.52	-			
-	0.00	0.00	-	200	3.41	2.11	-			
-	0.00	0.00	-	-	0.00	0.00	-			
-	0.00	0.00	-	-	0.00	0.00	-			
-	0.00	0.00	-	-	0.00	0.00	-			
-	0.00	0.00	-	-	0.00	0.00	-			
-	0.00	0.00	-	-	0.00	0.00	-			

PAN = 2.1%
 WASH LOSS WAS NOT TESTED.

SPECIFICATION: ASTM C 136
 TEST STANDARD: NA
 NOTES: NONE

Dunn Geoscience Laboratory

5 Northway Lane North, Latham, NY 12110 (518) 783-8102

CLIENT: GENERAL ELECTRIC COMPANY, NOTT ST.
 LAB NUMBER: 12945 DATE RECEIVED: 7/5/84
 TEST BY: JWH DATE TESTED: 7/16/84
 REVIEWED BY: *Jed* DATE REPORTED: 7/17/84
 SAMPLE DESCR: BORING DGC 11 S, S-1, 32.0'-34.0'

GRAIN SIZE DISTRIBUTION

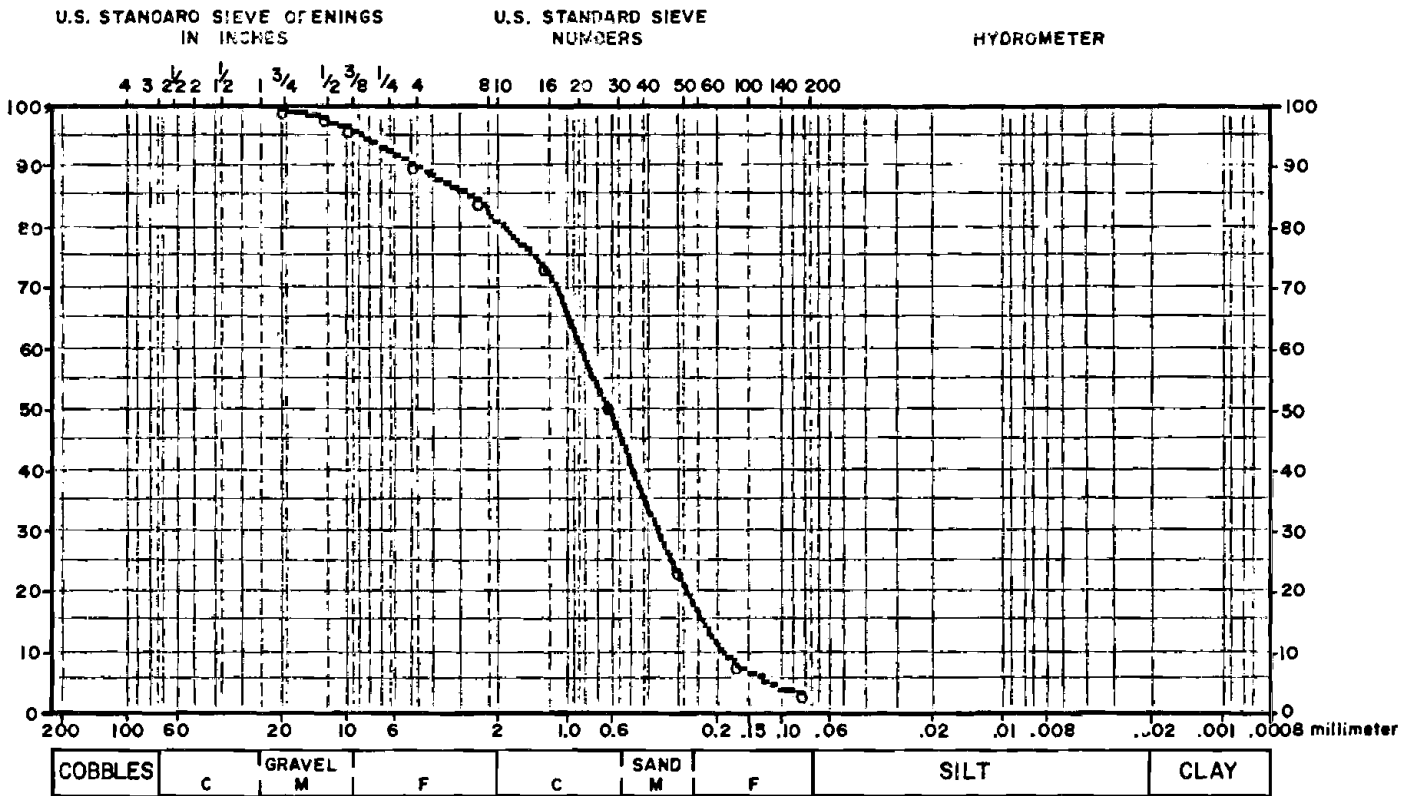

COARSE				FINE				HYDROMETER		
SIZE (Inches)	PERCENT RETAINED	CUMULATIVE PERCENT PASSING	SPECS.	SIEVE	PERCENT RETAINED	CUMULATIVE PERCENT PASSING	SPECS.	PARTICLE DIAMETER (mm)	PERCENT PASSING	SPECS.
3/4	0.00	100.00	-	4	5.80	90.77	-			
1/2	1.59	98.41	-	8	6.12	84.65	-			
3/8	1.84	96.58	-	16	10.37	74.29	-			
-	0.00	0.00	-	30	23.18	51.11	-			
-	0.00	0.00	-	50	27.11	24.00	-			
-	0.00	0.00	-	100	15.41	8.59	-			
-	0.00	0.00	-	200	5.20	3.39	-			
-	0.00	0.00	-	-	0.00	0.00	-			
-	0.00	0.00	-	-	0.00	0.00	-			
-	0.00	0.00	-	-	0.00	0.00	-			
-	0.00	0.00	-	-	0.00	0.00	-			
-	0.00	0.00	-	-	0.00	0.00	-			
-	0.00	0.00	-	-	0.00	0.00	-			

PAN = 3.4%
 WASH LOSS WAS NOT TESTED.

SPECIFICATION: ASTM C 136
 TEST STANDARD: NA
 NOTES: NONE

Dunn Geoscience Laboratory

5 Northway Lane North, Latham, NY 12110 (518) 783-8102

CLIENT: GENERAL ELECTRIC COMPANY, NOTT ST.
 LAB NUMBER: 12946 DATE RECEIVED: 7/5/84
 TEST BY: JWA DATE TESTED: 7/16/84
 REVIEWED BY: *[Signature]* DATE REPORTED: 7/17/84
 SAMPLE DESCR: BORING DGC 12, S-10, 45.0'-47.0'

GRAIN SIZE DISTRIBUTION

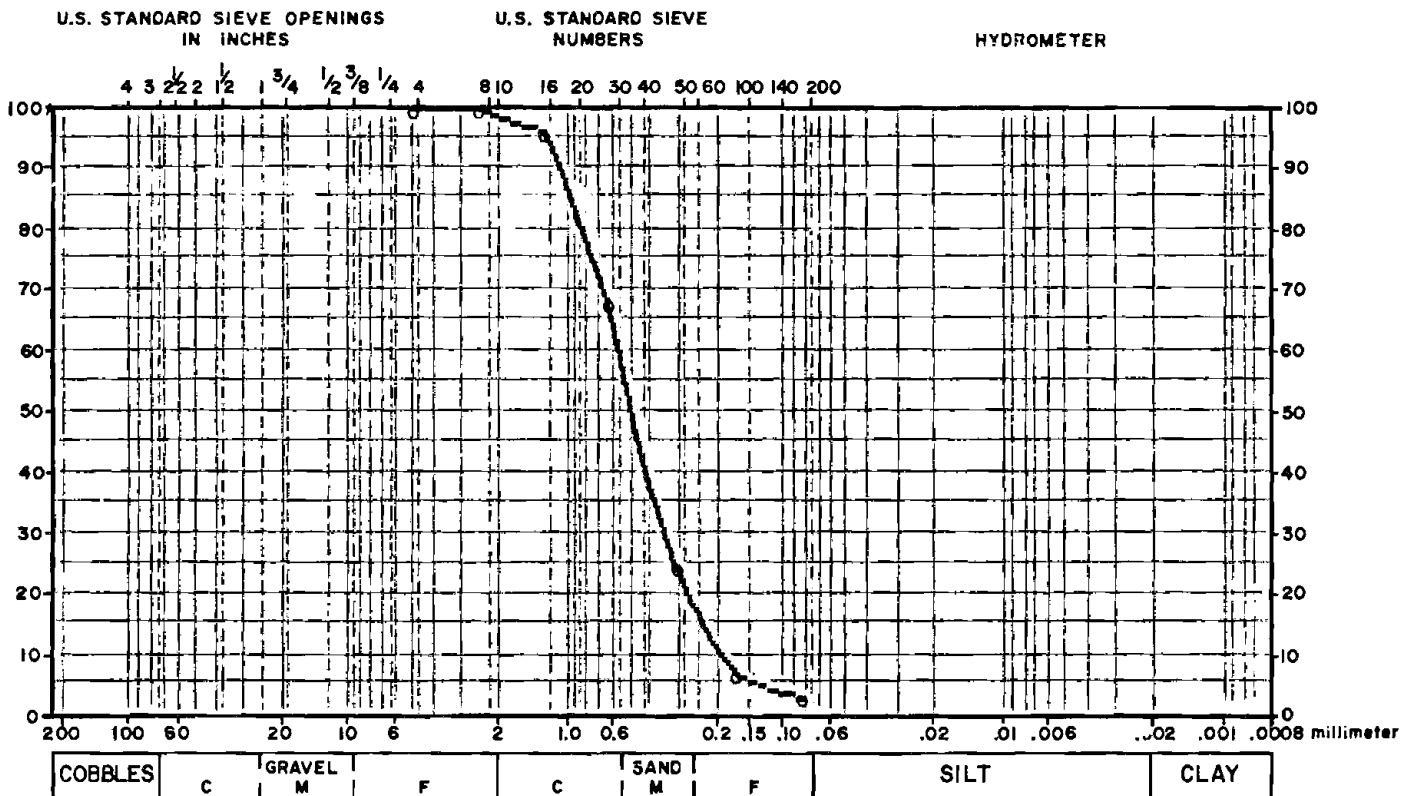

COARSE				FINE				HYDROMETER		
SIZE (inches)	PERCENT RETAINED	CUMULATIVE PERCENT PASSING	SPECS.	SIEVE	PERCENT RETAINED	CUMULATIVE PERCENT PASSING	SPECS.	PARTICLE DIAMETER (mm)	PERCENT PASSING	SPECS.
-	0.00	0.00	-	4	0.00	100.00	-			
-	0.00	0.00	-	8	.20	99.80	-			
-	0.00	0.00	-	16	4.07	95.73	-			
-	0.00	0.00	-	30	27.42	68.31	-			
-	0.00	0.00	-	50	43.37	24.94	-			
-	0.00	0.00	-	100	17.78	7.16	-			
-	0.00	0.00	-	200	4.56	2.60	-			
-	0.00	0.00	-	-	0.00	0.00	-			
-	0.00	0.00	-	-	0.00	0.00	-			
-	0.00	0.00	-	-	0.00	0.00	-			
-	0.00	0.00	-	-	0.00	0.00	-			
-	0.00	0.00	-	-	0.00	0.00	-			

PAN = 2.6%
 WASH LOSS WAS NOT TESTED.

SPECIFICATION: ASTM C 136

TEST STANDARD: NA

NOTES: NONE

Dunn Geoscience Laboratory

5 Northway Lane North, Latham, NY 12110 (518) 783-8102

CLIENT:	GENERAL ELECTRIC COMPANY	NOTT STREET
LAB NUMBER:	12947	DATE RECEIVED: 7/5/84
TEST BY:	JWH	DATE TESTED: 7/17/84
REVIEWED BY:	<i>M93</i>	DATE REPORTED: 7/24/84
SAMPLE DESCR:	BORING DCC-12	S-13 60.0' - 62.0'

GRAIN SIZE DISTRIBUTION

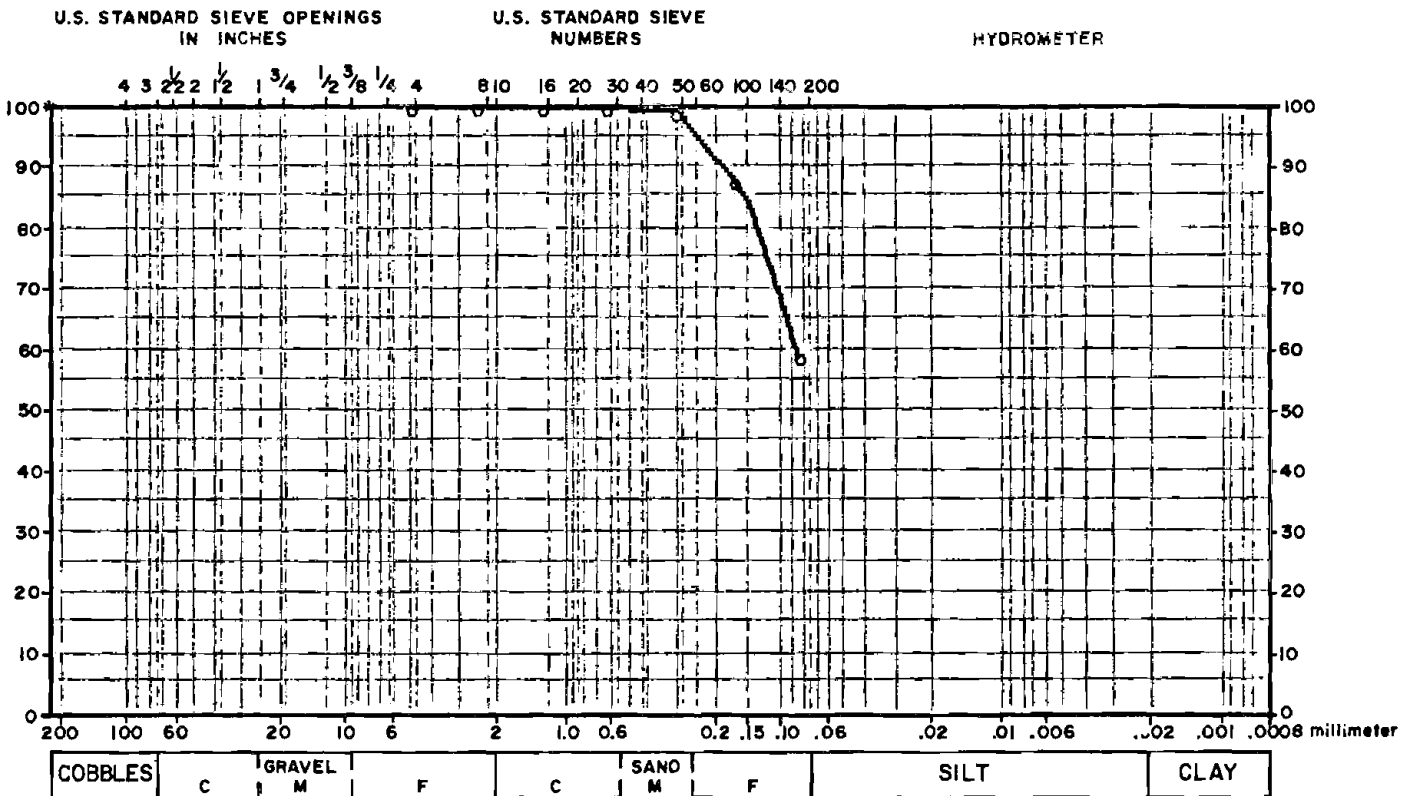

COARSE				FINE				HYDROMETER		
SIZE (inches)	PERCENT RETAINED	CUMULATIVE PERCENT PASSING	SPECS.	SIEVE	PERCENT RETAINED	CUMULATIVE PERCENT PASSING	SPECS.	PARTICLE DIAMETER (mm)	PERCENT PASSING	SPECS.
-	0.00	0.00	-	4	0.00	100.00	-	-	-	-
-	0.00	0.00	-	8	0.00	100.00	-	-	-	-
-	0.00	0.00	-	16	0.00	100.00	-	-	-	-
-	0.00	0.00	-	30	.07	99.93	-	-	-	-
-	0.00	0.00	-	50	.64	99.29	-	-	-	-
-	0.00	0.00	-	100	11.02	88.27	-	-	-	-
-	0.00	0.00	-	200	29.89	58.37	-	-	-	-
-	0.00	0.00	-	-	0.00	0.00	-	-	-	-
-	0.00	0.00	-	-	0.00	0.00	-	-	-	-
-	0.00	0.00	-	-	0.00	0.00	-	-	-	-
-	0.00	0.00	-	-	0.00	0.00	-	-	-	-
-	0.00	0.00	-	-	0.00	0.00	-	-	-	-
-	0.00	0.00	-	-	0.00	0.00	-	-	-	-

PAN = 58.4%
WASH LOSS = 46.5%

SPECIFICATION: ASTM C-136 ASTM C-117
TEST STANDARD: NONE
NOTES: NONE

Test samples are retained for 30 days after submission

Dunn Geoscience Laboratory

5 Northway Lane North, Latham, NY 12110 (518) 783-8102

CLIENT:	GENERAL ELECTRIC COMPANY	NOTT STREET
LAB NUMBER:	12948	DATE RECEIVED: 7/5/84
TEST BY:	JWH	DATE TESTED: 7/17/84
REVIEWED BY:	<i>MJ3</i>	DATE REPORTED: 7/24/84
SAMPLE DESCR:	BORING DGC-121 S-2	35.0' - 37.0'

GRAIN SIZE DISTRIBUTION

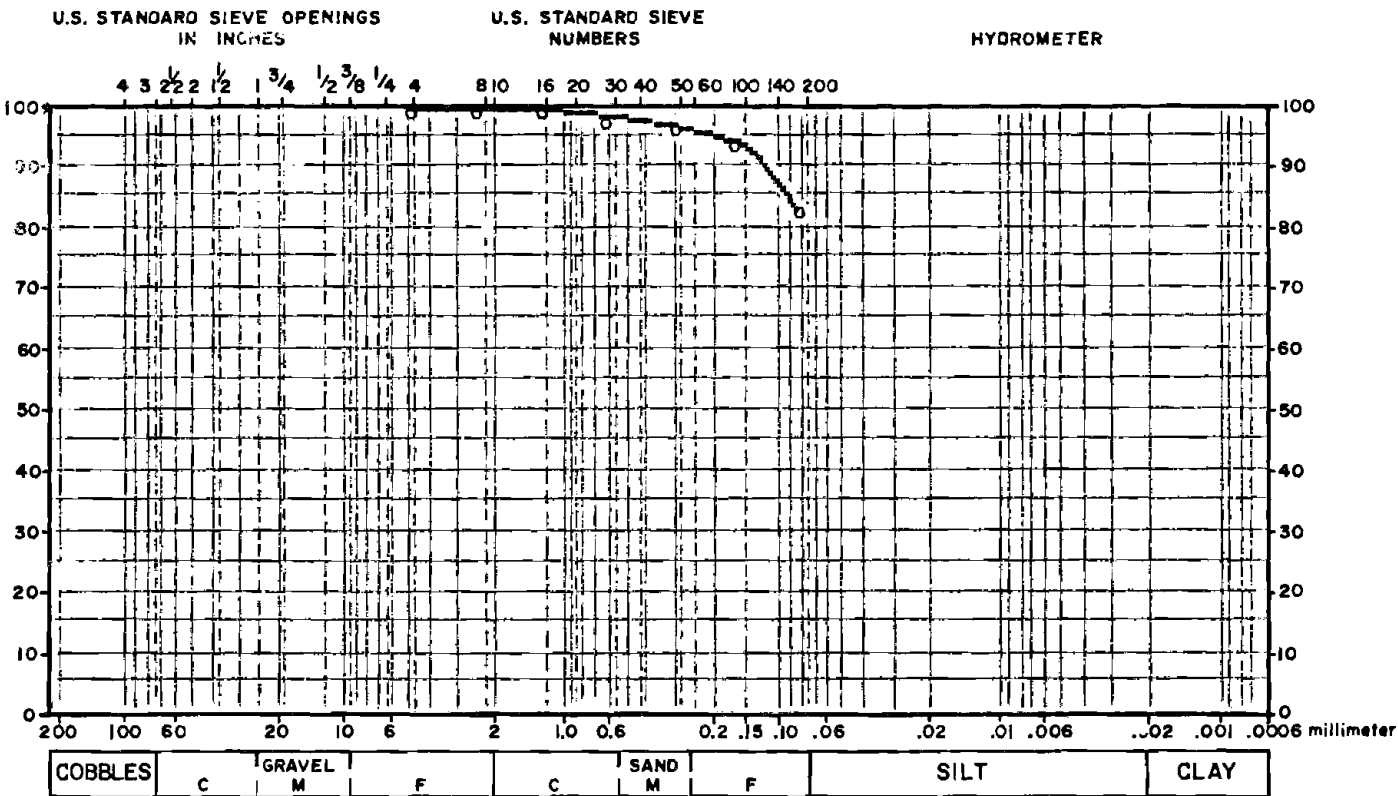

COBBLES	C	GRAVEL	M	F	C	SAND	M	F	SILT	CLAY
---------	---	--------	---	---	---	------	---	---	------	------

COARSE				FINE				HYDROMETER		
SIZE (inches)	PERCENT RETAINED	CUMULATIVE PERCENT PASSING	SPECS.	SIEVE	PERCENT RETAINED	CUMULATIVE PERCENT PASSING	SPECS.	PARTICLE DIAMETER (mm)	PERCENT PASSING	SPECS.
-	0.00	0.00	-	4	0.00	100.00	-			
-	0.00	0.00	-	8	0.00	100.00	-			
-	0.00	0.00	-	16	.07	99.93	-			
-	0.00	0.00	-	30	.97	98.95	-			
-	0.00	0.00	-	50	1.72	97.23	-			
-	0.00	0.00	-	100	2.24	94.99	-			
-	0.00	0.00	-	200	11.59	83.40	-			
-	0.00	0.00	-	-	0.00	0.00	-			
-	0.00	0.00	-	-	0.00	0.00	-			
-	0.00	0.00	-	-	0.00	0.00	-			
-	0.00	0.00	-	-	0.00	0.00	-			
-	0.00	0.00	-	-	0.00	0.00	-			
-	0.00	0.00	-	-	0.00	0.00	-			
-	0.00	0.00	-	-	0.00	0.00	-			

PAN = 83.4%
WASH LOSS = 81.0%

SPECIFICATION: ASTM C-136 ASTM C-117

TEST STANDARD: NONE

NOTES: NONE

Best samples are retained for 30 days after submission

Dunn Geoscience Laboratory

5 Northway Lane North, Latham, NY 12110 (518) 783-8102

CLIENT: GENERAL ELECTRIC COMPANY, NOTT ST.
 LAB NUMBER: 12949 DATE RECEIVED: 7/5/84
 TEST BY: JWH DATE TESTED: 7/16/84
 REVIEWED BY: *JH* DATE REPORTED: 7/17/84
 SAMPLE DESCR: BORING DGC 12 S, S-2, 23.0'-25.0'

GRAIN SIZE DISTRIBUTION

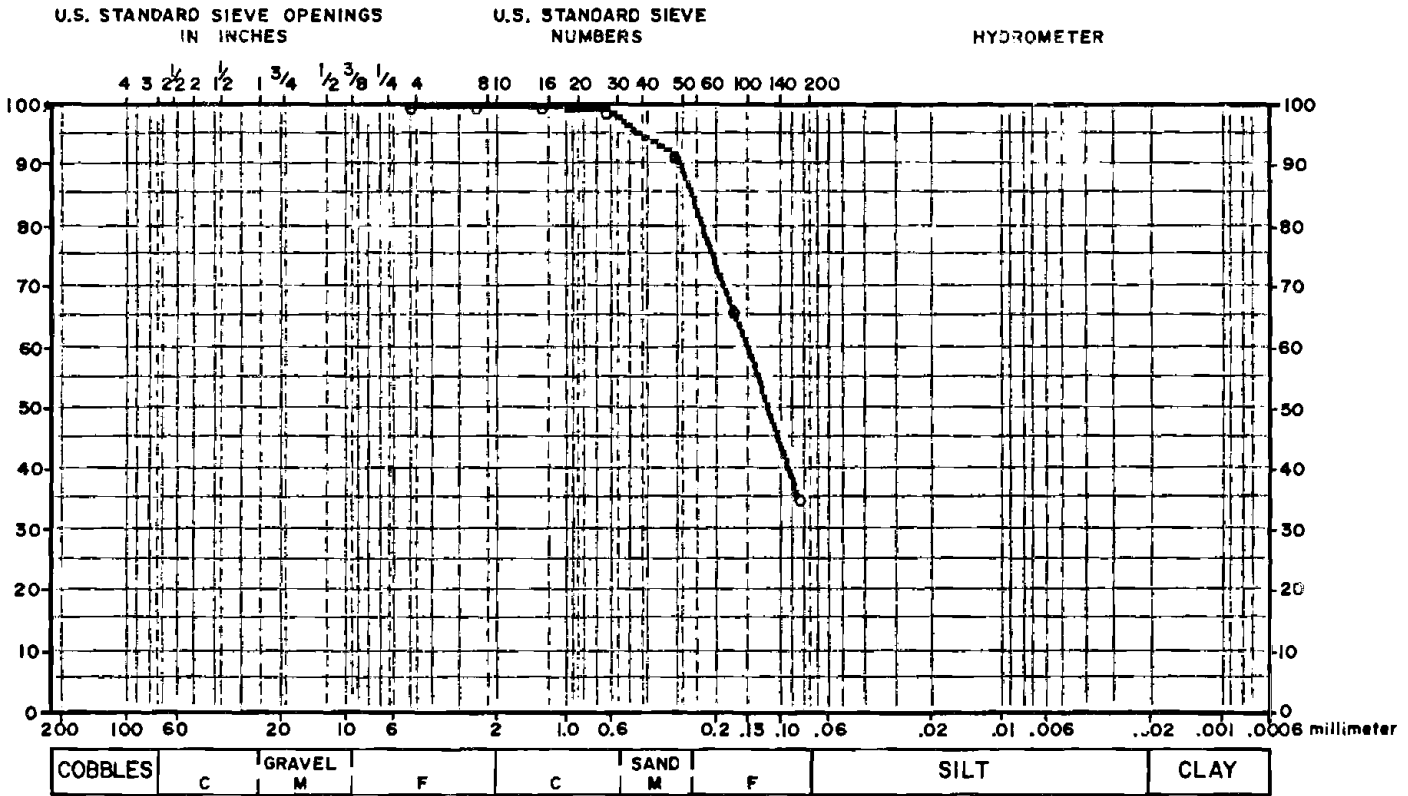

COARSE				FINE				HYDROMETER		
SIZE (Inches)	PERCENT RETAINED	CUMULATIVE PERCENT PASSING	SPECS.	SIEVE	PERCENT RETAINED	CUMULATIVE PERCENT PASSING	SPECS.	PARTICLE DIAMETER (mm)	PERCENT PASSING	SPECS.
-	0.00	0.00	-	4	0.00	100.00	-			
-	0.00	0.00	-	8	0.00	100.00	-			
-	0.00	0.00	-	16	0.00	100.00	-			
-	0.00	0.00	-	30	0.85	99.15	-			
-	0.00	0.00	-	50	7.41	91.75	-			
-	0.00	0.00	-	100	24.81	66.94	-			
-	0.00	0.00	-	200	31.28	35.66	-			
-	0.00	0.00	-	-	0.00	0.00	-			
-	0.00	0.00	-	-	0.00	0.00	-			
-	0.00	0.00	-	-	0.00	0.00	-			
-	0.00	0.00	-	-	0.00	0.00	-			

PAN = 35.7%
 WASH LOSS WAS NOT TESTED.

SPECIFICATION: ASTM C 136
 TEST STANDARD: NA
 NOTES: NONE

Dunn Geoscience Laboratory

5 Northway Lane North, Latham, NY 12110 (518) 783-8102

CLIENT: GENERAL ELECTRIC COMPANY, NOTT ST.
 LAB NUMBER: 12950 DATE RECEIVED: 7/5/84
 TEST BY: JWH DATE TESTED: 7/12/84
 REVIEWED BY: *fed* DATE REPORTED: 7/17/84
 SAMPLE DESCR: BORING DGC 13, S-2, 5.0'-7.0'

GRAIN SIZE DISTRIBUTION

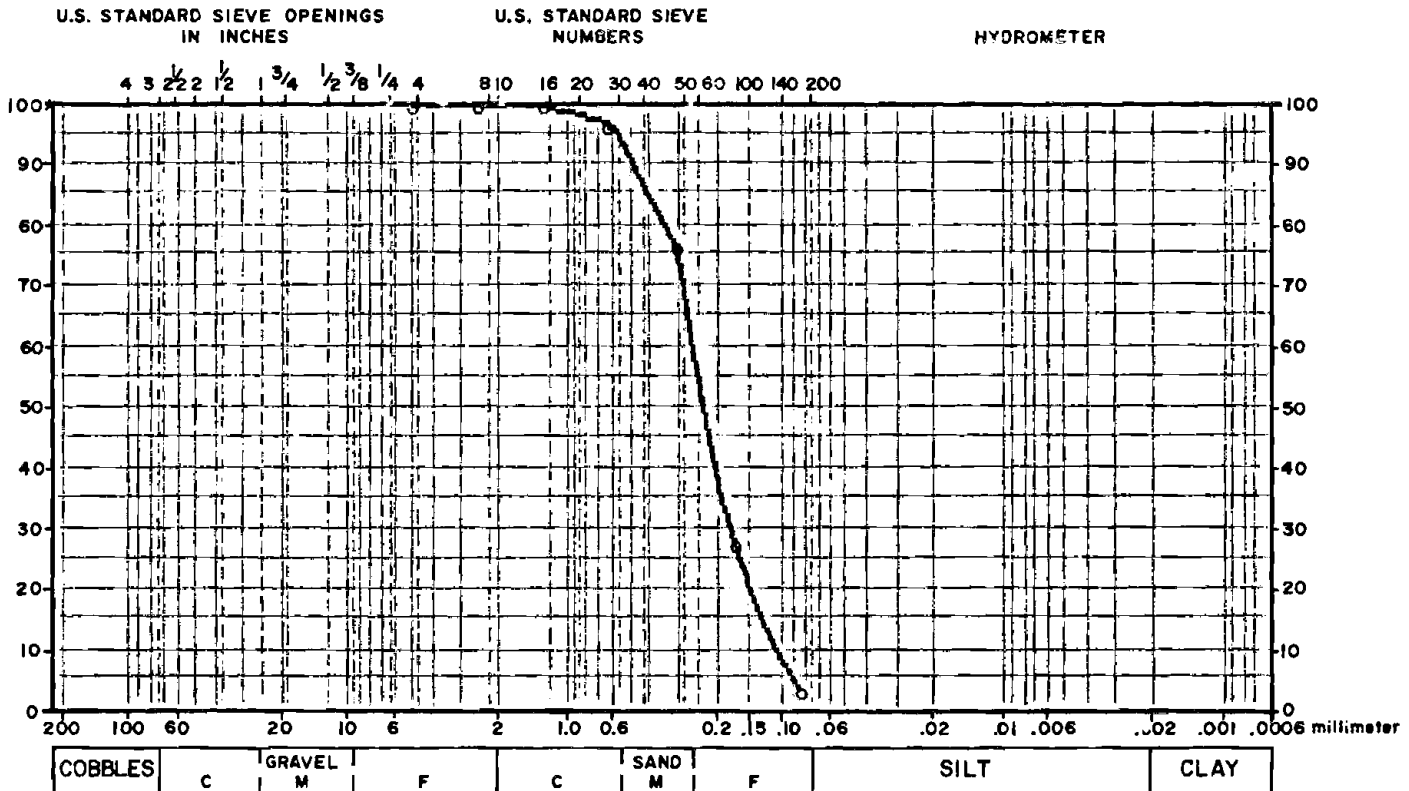

COARSE				FINE				HYDROMETER		
SIZE (Inches)	PERCENT RETAINED	CUMULATIVE PERCENT PASSING	SPECS.	SIEVE	PERCENT RETAINED	CUMULATIVE PERCENT PASSING	SPECS.	PARTICLE DIAMETER (mm)	PERCENT PASSING	SPECS.
-	0.00	0.00	-	4	0.00	100.00	-	-	-	-
-	0.00	0.00	-	8	0.00	100.00	-	-	-	-
-	0.00	0.00	-	16	.21	99.79	-	-	-	-
-	0.00	0.00	-	30	3.08	96.70	-	-	-	-
-	0.00	0.00	-	50	19.74	76.96	-	-	-	-
-	0.00	0.00	-	100	48.92	28.04	-	-	-	-
-	0.00	0.00	-	200	24.53	3.51	-	-	-	-
-	0.00	0.00	-	-	0.00	0.00	-	-	-	-
-	0.00	0.00	-	-	0.00	0.00	-	-	-	-
-	0.00	0.00	-	-	0.00	0.00	-	-	-	-
-	0.00	0.00	-	-	0.00	0.00	-	-	-	-
-	0.00	0.00	-	-	0.00	0.00	-	-	-	-

PAN = 3.5%
 WASH LOSS WAS NOT TESTED.

SPECIFICATION: ASTM C 136
 TEST STANDARD: NA
 NOTES: NONE

Dunn Geoscience Laboratory

5 Northway Lane North, Latham, NY 12110 (518) 783-8102

CLIENT:	GENERAL ELECTRIC COMPANY	DATE RECEIVED:	8/23/84
LAB NUMBER:	84-8-47	DATE TESTED:	8/24/84
TEST BY:	JWH	DATE REPORTED:	8/27/84
REVIEWED BY:	<i>MJZ</i>		
SAMPLE DESCR:	TEST BORING DGC-14	S-6	25.0' - 27.0'

GRAIN SIZE DISTRIBUTION

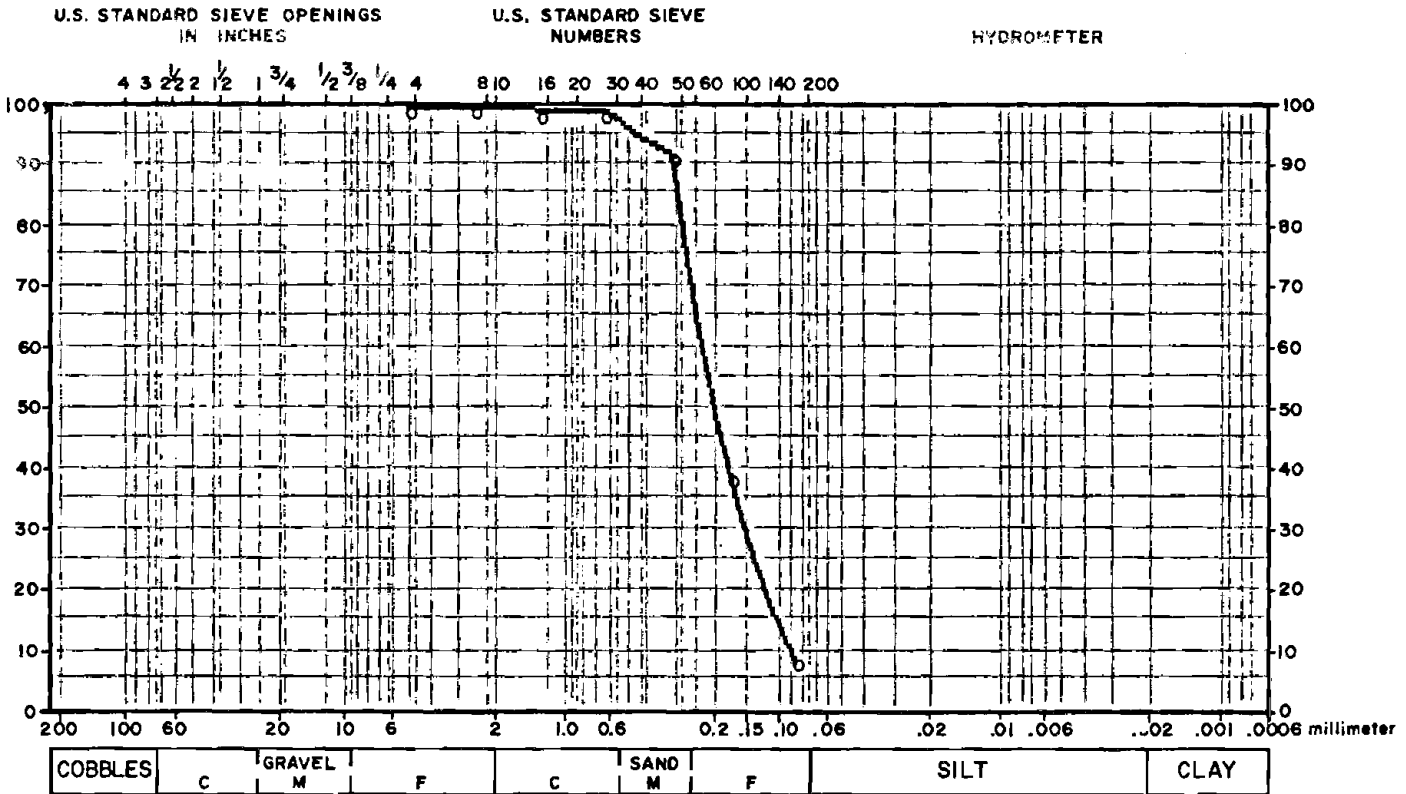

COARSE				FINE				HYDROMETER		
SIZE (inches)	PERCENT RETAINED	CUMULATIVE PERCENT PASSING	SPECS.	SIEVE	PERCENT RETAINED	CUMULATIVE PERCENT PASSING	SPECS.	PARTICLE DIAMETER (mm)	PERCENT PASSING	SPECS.
-	0.00	0.00	-	4	0.00	100.00	-			
-	0.00	0.00	-	8	.03	99.97	-			
-	0.00	0.00	-	16	.34	99.62	-			
-	0.00	0.00	-	30	.34	99.28	-			
-	0.00	0.00	-	50	7.38	91.90	-			
-	0.00	0.00	-	100	52.75	39.15	-			
-	0.00	0.00	-	200	30.34	8.81	-			
-	0.00	0.00	-	-	0.00	0.00	-			
-	0.00	0.00	-	-	0.00	0.00	-			
-	0.00	0.00	-	-	0.00	0.00	-			
-	0.00	0.00	-	-	0.00	0.00	-			

PAN = 8.8%
WASH LOSS WAS NOT TESTED.

SPECIFICATION: ASTM C 136

TEST STANDARD: NONE

NOTES: NONE

Test samples are retained for 30 days after submission and then discarded, unless other arrangements are made.

Dunn Geoscience Laboratory

5 Northway Lane North, Latham, NY 12110 (518) 783-8102

CLIENT: GENERAL ELECTRIC COMPANY
 LAB NUMBER: 84-8-48 DATE RECEIVED: 8/23/84
 TEST BY: JWH DATE TESTED: 8/24/84
 REVIEWED BY: *MJZ* DATE REPORTED: 8/27/84
 SAMPLE DESCR: TEST BORING DCC-14 S-11 50.0' - 52.0'

GRAIN SIZE DISTRIBUTION

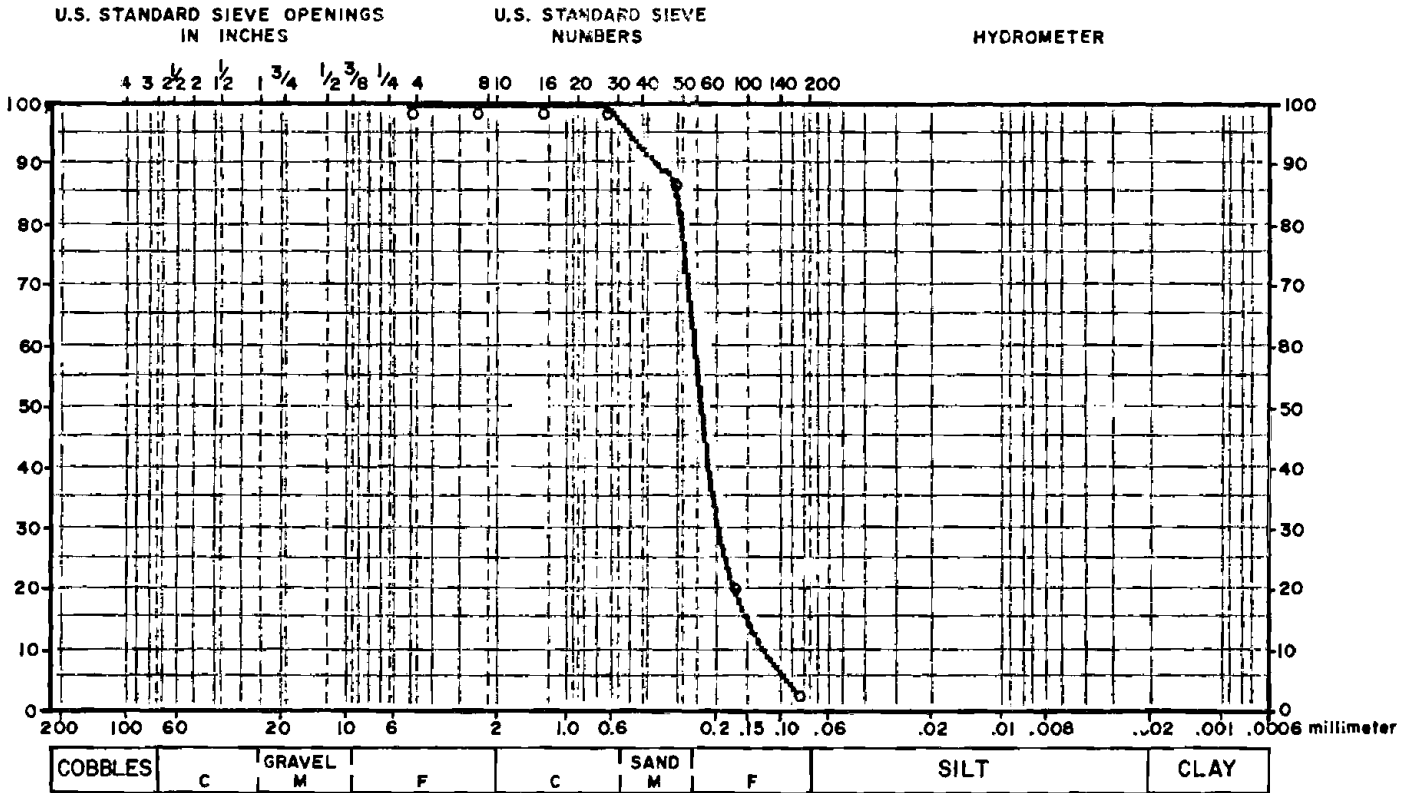

COARSE				FINE				HYDROMETER		
SIZE (inches)	PERCENT RETAINED	CUMULATIVE PERCENT PASSING	SPECS.	SIEVE	PERCENT RETAINED	CUMULATIVE PERCENT PASSING	SPECS.	PARTICLE DIAMETER (mm)	PERCENT PASSING	SPECS.

-	0.00	0.00	-	4	0.00	100.00	-			
-	0.00	0.00	-	8	0.00	100.00	-			
-	0.00	0.00	-	16	.04	99.96	-			
-	0.00	0.00	-	30	.19	99.78	-			
-	0.00	0.00	-	50	12.06	87.71	-			
-	0.00	0.00	-	100	66.53	21.18	-			
-	0.00	0.00	-	200	18.17	3.02	-			
-	0.00	0.00	-	-	0.00	0.00	-			
-	0.00	0.00	-	-	0.00	0.00	-			
-	0.00	0.00	-	-	0.00	0.00	-			
-	0.00	0.00	-	-	0.00	0.00	-			

PAN = 3.0%

WASH LOSS WAS NOT TESTED.

SPECIFICATION: ASTM C 136

TEST STANDARD: NONE

NOTES: NONE

Test samples are retained for 30 days after submission and then discarded, unless other arrangements are made.

Dunn Geoscience Laboratory

5 Northway Lane North, Latham, NY 12110 (518) 783-8102

CLIENT: GENERAL ELECTRIC COMPANY
 LAB NUMBER: 84-8-49 DATE RECEIVED: 8/23/84
 TEST BY: JWH DATE TESTED: 8/24/84
 REVIEWED BY: *MJZ* DATE REPORTED: 8/27/84
 SAMPLE DESCR: TEST BORING DGC-14 S-18 85.0' - 87.0'

GRAIN SIZE DISTRIBUTION

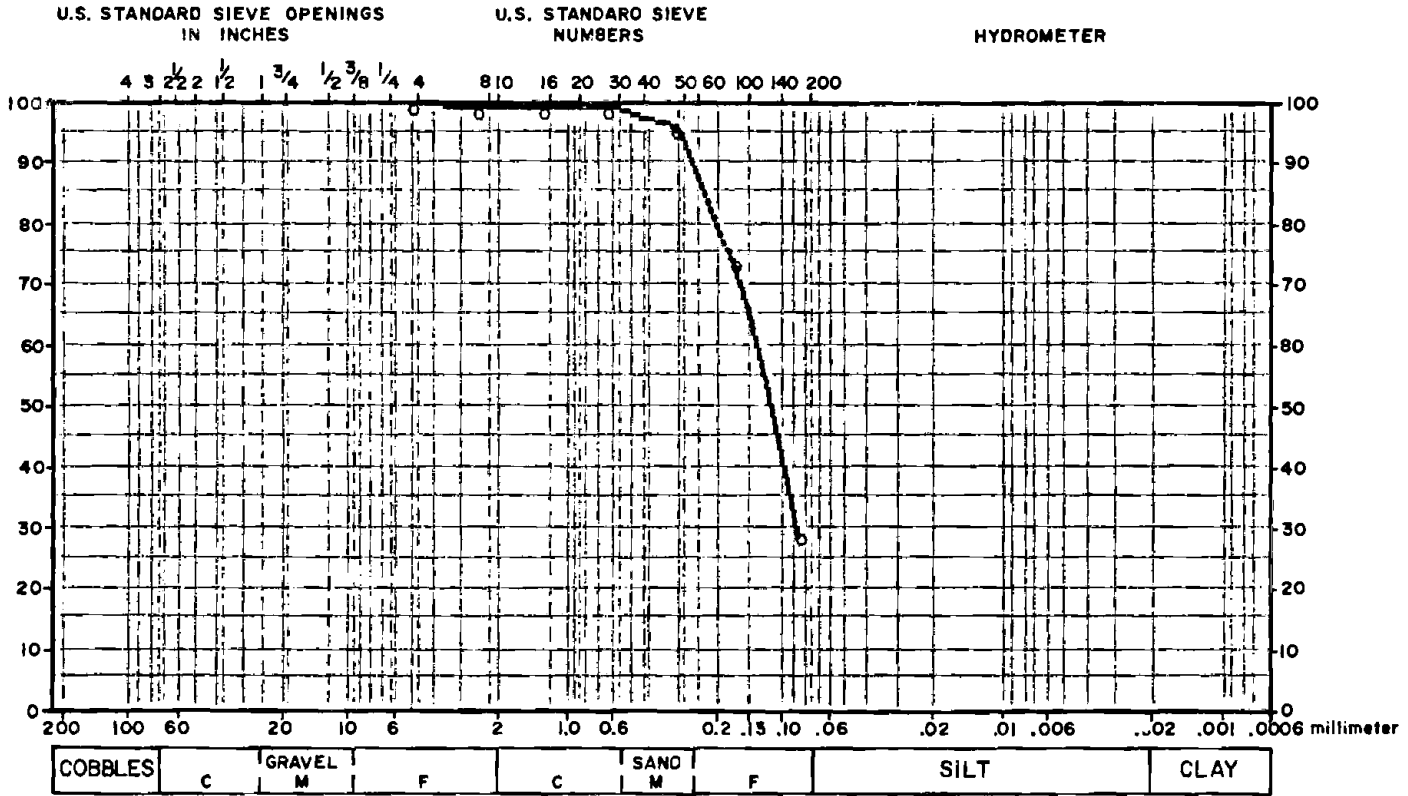

COARSE				FINE				HYDROMETER		
SIZE (inches)	PERCENT RETAINED	CUMULATIVE PERCENT PASSING	SPECS.	SIEVE	PERCENT RETAINED	CUMULATIVE PERCENT PASSING	SPECS.	PARTICLE DIAMETER (mm)	PERCENT PASSING	SPECS.
-	0.00	0.00	-	4	.14	99.86	-			
-	0.00	0.00	-	8	.28	99.58	-			
-	0.00	0.00	-	16	.08	99.49	-			
-	0.00	0.00	-	30	.08	99.41	-			
-	0.00	0.00	-	50	3.19	96.22	-			
-	0.00	0.00	-	100	22.55	73.67	-			
-	0.00	0.00	-	200	45.11	28.56	.3			
-	0.00	0.00	-	-	0.00	0.00	-			
-	0.00	0.00	-	-	0.00	0.00	-			
-	0.00	0.00	-	-	0.00	0.00	-			
-	0.00	0.00	-	-	0.00	0.00	-			

PAN = 28.5%
 WASH LOSS WAS NOT TESTED.

SPECIFICATION: ASTM C 136

TEST STANDARD: NONE

NOTES: NONE

Test samples are retained for 30 days after submission and then discarded, unless other arrangements are made.

Dunn Geoscience Laboratory

5 Northway Lane North, Latham, NY 12110 (518) 783-8102

CLIENT:	GENERAL ELECTRIC	NOTT STREET	
LAB NUMBER:	84-8-42	DATE RECEIVED:	8/23/84
TEST BY:	JWH	DATE TESTED:	8/24/84
REVIEWED BY:	<i>MJZ</i>	DATE REPORTED:	8/27/84
SAMPLE DESCR:	TEST BORING DGC-15	S-11	20.0' - 22.0'

GRAIN SIZE DISTRIBUTION

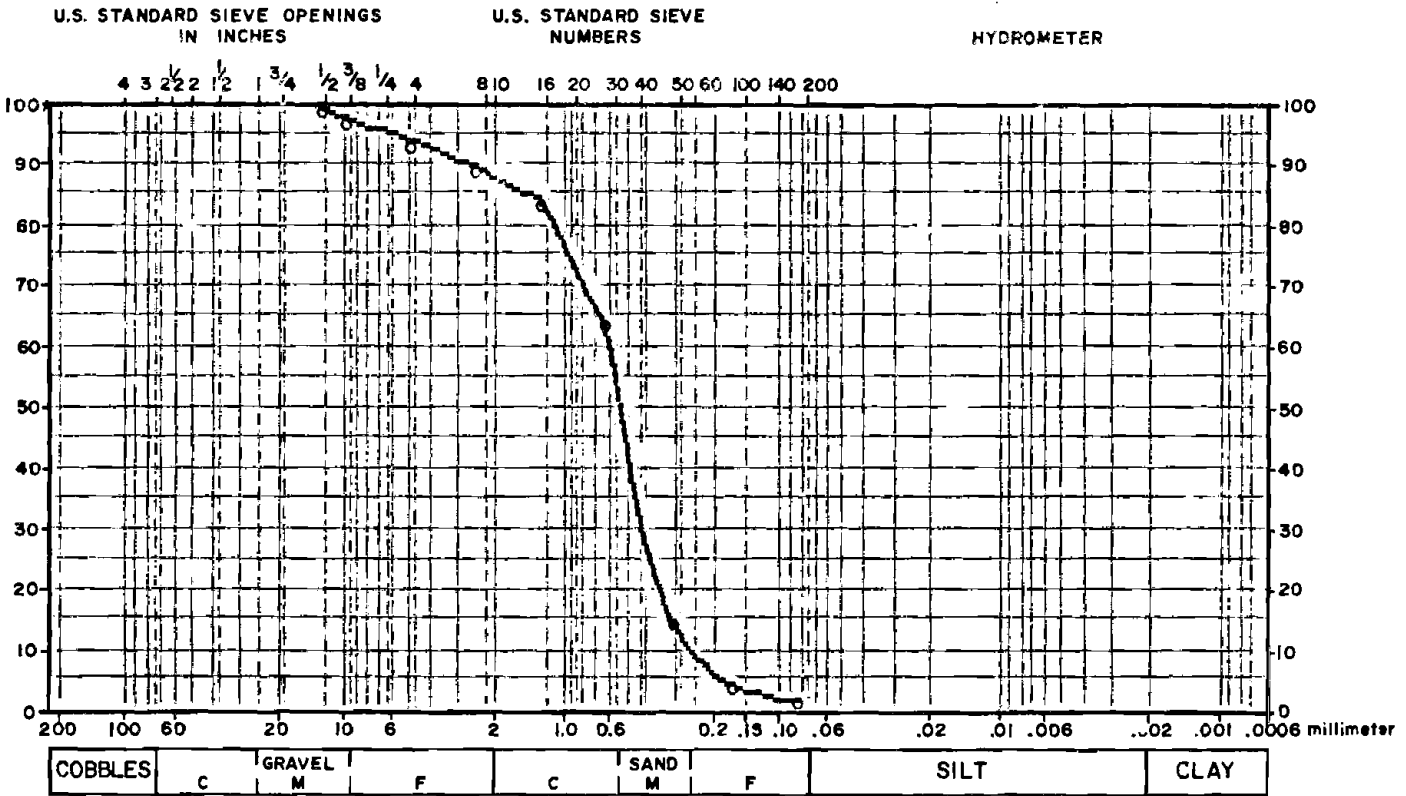

COARSE				FINE				HYDROMETER		
SIZE (inches)	PERCENT RETAINED	CUMULATIVE PERCENT PASSING	SPECS.	SIEVE	PERCENT RETAINED	CUMULATIVE PERCENT PASSING	SPECS.	PARTICLE DIAMETER (mm)	PERCENT PASSING	SPECS.
1/2	0.00	100.00	-	3/8	2.04	97.96	-			
-	0.00	0.00	-	4	3.63	94.33	-			
-	0.00	0.00	-	8	4.42	89.91	-			
-	0.00	0.00	-	16	5.58	84.34	-			
-	0.00	0.00	-	30	19.96	64.38	-			
-	0.00	0.00	-	50	48.75	15.63	-			
-	0.00	0.00	-	100	11.15	4.48	-			
-	0.00	0.00	-	200	2.66	1.82	-			
-	0.00	0.00	-	-	0.00	0.00	-			
-	0.00	0.00	-	-	0.00	0.00	-			
-	0.00	0.00	-	-	0.00	0.00	-			
-	0.00	0.00	-	-	0.00	0.00	-			

PAN = 1.8%
WASH LOSS WAS NOT TESTED.

SPECIFICATION: ASTM C 136

TEST STANDARD: NONE

NOTES: NONE

Test samples are retained for 30 days after submission and then discarded, unless other arrangements are made.

Dunn Geoscience Laboratory

5 Northway Lane North, Latham, NY 12110 (518) 783-8102

CLIENT:	GENERAL ELECTRIC COMPANY, NOTT STREET		
LAB NUMBER:	84-8-43	DATE RECEIVED:	8/23/84
TEST BY:	JWH	DATE TESTED:	8/24/84
REVIEWED BY:	<i>MJZ</i>	DATE REPORTED:	8/27/84
SAMPLE DESCR:	TEST BORING DGC-15	S-22	42.0' - 44.0'

GRAIN SIZE DISTRIBUTION

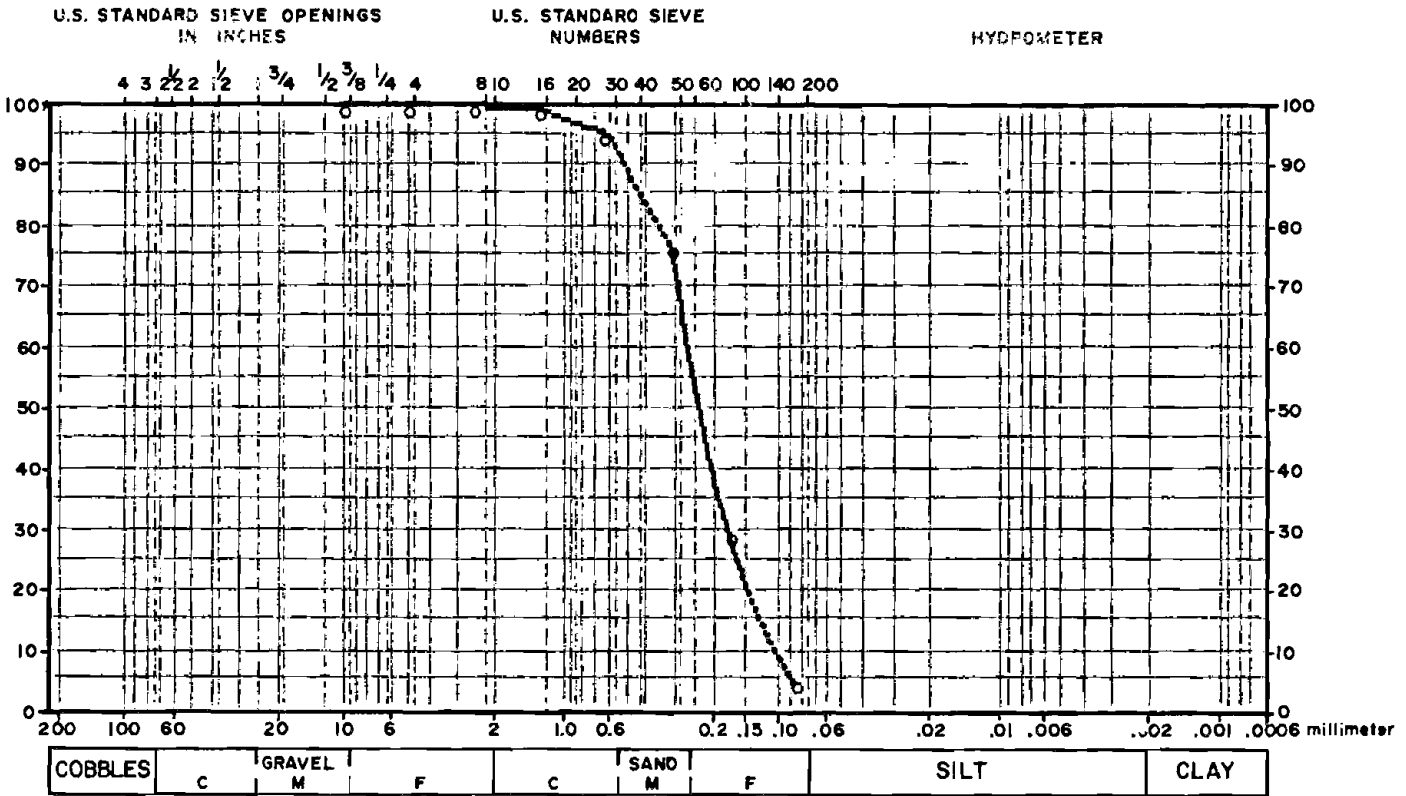

COARSE				FINE				HYDROMETER		
SIZE (Inches)	PERCENT RETAINED	CUMULATIVE PERCENT PASSING	SPECS.	SIEVE	PERCENT RETAINED	CUMULATIVE PERCENT PASSING	SPECS.	PARTICLE DIAMETER (mm)	PERCENT PASSING	SPECS.
-	0.00	0.00	-	3/8	0.00	100.00	-			
-	0.00	0.00	-	4	.09	99.91	-			
-	0.00	0.00	-	8	.13	99.78	-			
-	0.00	0.00	-	16	.47	99.31	-			
-	0.00	0.00	-	30	4.03	95.28	-			
-	0.00	0.00	-	50	18.76	76.52	-			
-	0.00	0.00	-	100	47.17	29.35	-			
-	0.00	0.00	-	200	24.60	4.75	-			
-	0.00	0.00	-	-	0.00	0.00	-			
-	0.00	0.00	-	-	0.00	0.00	-			
-	0.00	0.00	-	-	0.00	0.00	-			
-	0.00	0.00	-	-	0.00	0.00	-			

PAN = 4.8%
WASH LOSS WAS NOT TESTED.

SPECIFICATION: ASTM C 136

TEST STANDARD: NONE
NOTES: NONE

Test samples are retained for 30 days after submission and then discarded, unless other arrangements are made.

Dunn Geoscience Laboratory

5 Northway Lane North, Latham, NY 12110 (518) 783-8102

CLIENT:	GENERAL ELECTRIC COMPANY, NOTT STREET		
LAB NUMBER:	84-8-44	DATE RECEIVED:	8/23/84
TEST BY:	JWH	DATE TESTED:	8/24/84
REVIEWED BY:	<i>MJZ</i>	DATE REPORTED:	8/27/84
SAMPLE DESCR:	TEB BORING DGC-15	S-29	56.0' - 58.0'

GRAIN SIZE DISTRIBUTION

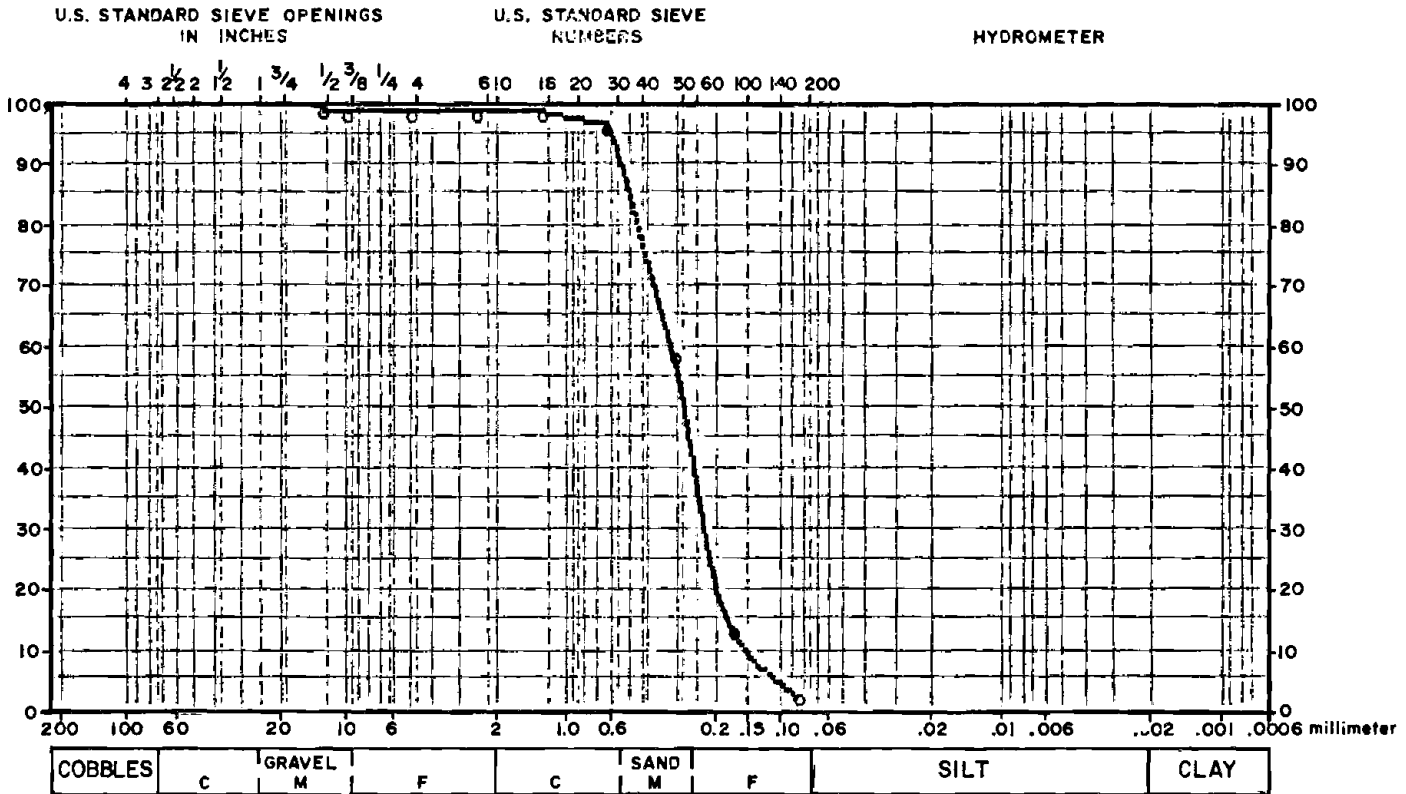

COARSE				FINE				HYDROMETER		
SIZE (inches)	PERCENT RETAINED	CUMULATIVE PERCENT PASSING	SPECS.	SIEVE	PERCENT RETAINED	CUMULATIVE PERCENT PASSING	SPECS.	PARTICLE DIAMETER (mm)	PERCENT PASSING	SPECS.
1/2	0.00	100.00	-	3/8	.76	99.24	-			
-	0.00	0.00	-	4	0.00	99.24	-			
-	0.00	0.00	-	8	0.00	99.24	-			
-	0.00	0.00	-	16	.05	99.19	-			
-	0.00	0.00	-	30	2.10	97.09	-			
-	0.00	0.00	-	50	37.53	59.56	-			
-	0.00	0.00	-	100	45.36	14.20	-			
-	0.00	0.00	-	200	11.31	2.88	-			
-	0.00	0.00	-	-	0.00	0.00	-			
-	0.00	0.00	-	-	0.00	0.00	-			
-	0.00	0.00	-	-	0.00	0.00	-			
-	0.00	0.00	-	-	0.00	0.00	-			

PAN = 2.9%
WASH LOSS WAS NOT TESTED.

SPECIFICATION: ASTM C 136

TEST STANDARD: NONE

NOTES: NONE

Test samples are retained for 30 days after submission and then discarded, unless other arrangements are made.

Dunn Geoscience Laboratory

5 Northway Lane North, Latham, NY 12110 (518) 783-8102

CLIENT: GENERAL ELECTRIC COMPANY, NOTT STREET
 LAB NUMBER: 84-8-45 DATE RECEIVED: 8/23/84
 TEST BY: JWH DATE TESTED: 8/24/84
 REVIEWED BY: *MBJ* DATE REPORTED: 8/27/84
 SAMPLE DESCR: TEST BORING DGC-15 S-48 94.0' - 96.0'

GRAIN SIZE DISTRIBUTION

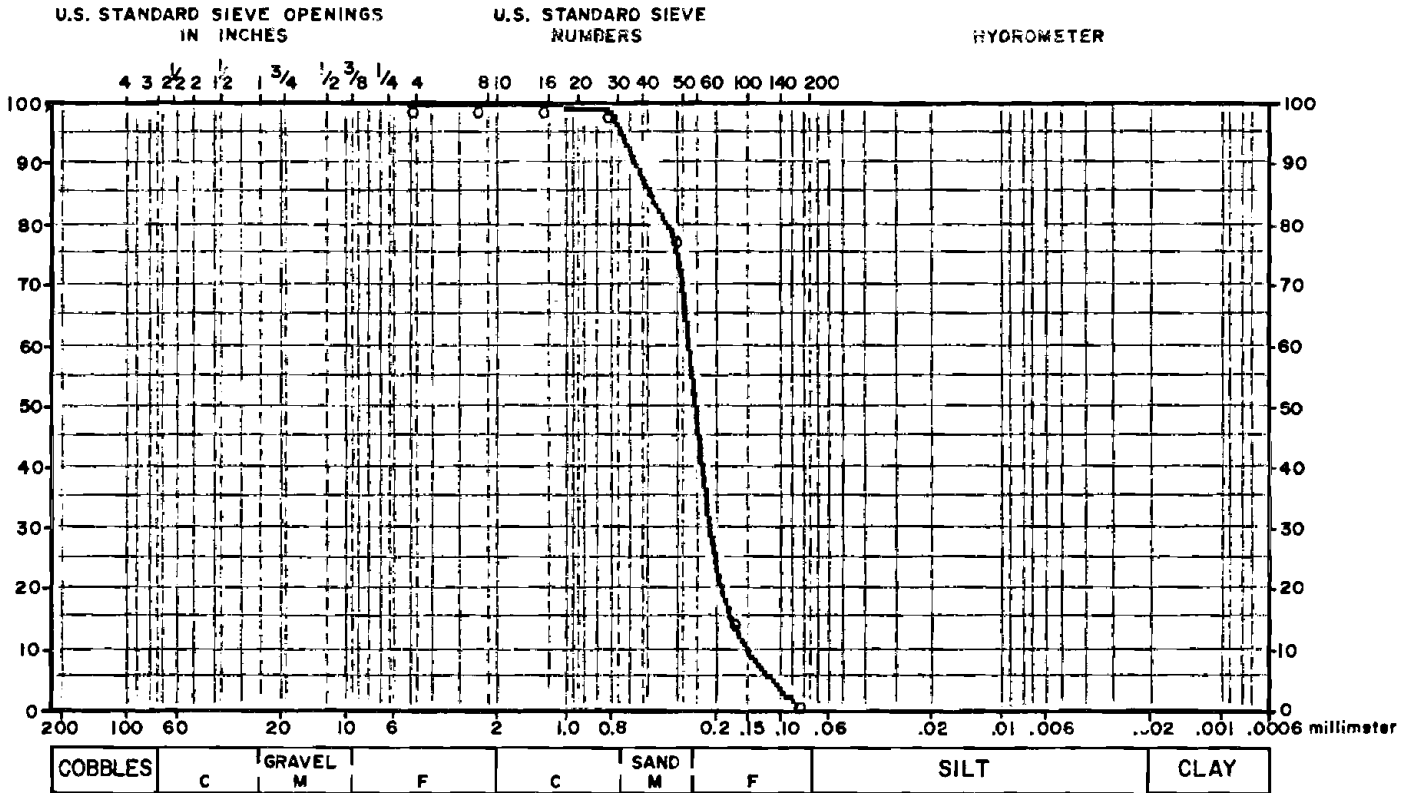

COARSE				FINE				HYDROMETER		
SIZE (inches)	PERCENT RETAINED	CUMULATIVE PERCENT PASSING	SPECS.	SIEVE	PERCENT RETAINED	CUMULATIVE PERCENT PASSING	SPECS.	PARTICLE DIAMETER (mm)	PERCENT PASSING	SPECS.
-	0.00	0.00	-	4	0.00	100.00	-			
-	0.00	0.00	-	8	.03	99.97	-			
-	0.00	0.00	-	16	.09	99.88	-			
-	0.00	0.00	-	30	.49	99.39	-			
-	0.00	0.00	-	50	20.75	78.65	-			
-	0.00	0.00	-	100	63.54	15.10	-			
-	0.00	0.00	-	200	13.51	1.59	-			
-	0.00	0.00	-	-	0.00	0.00	-			
-	0.00	0.00	-	-	0.00	0.00	-			
-	0.00	0.00	-	-	0.00	0.00	-			
-	0.00	0.00	-	-	0.00	0.00	-			
-	0.00	0.00	-	-	0.00	0.00	-			
-	0.00	0.00	-	-	0.00	0.00	-			

FAN = 1.6%
 WASH LOSS WAS NOT TESTED.

SPECIFICATION: ASTM C 136

TEST STANDARD: NONE

NOTES: NONE

Test samples are retained for 30 days after submission and then discarded, unless other arrangements are made.

Dunn Geoscience Laboratory

5 Northway Lane North, Latham, NY 12110 (518) 783-8102

CLIENT:	GENERAL ELECTRIC COMPANY	NOTT STREET
LAB NUMBER:	84-8-46	DATE RECEIVED: 8/24/84
TEST BY:	JWH	DATE TESTED: 8/25/84
REVIEWED BY:	<i>MJZ</i>	DATE REPORTED: 8/31/84
SAMPLE DESCR:	TEST BORING DGC-15	S-59 116.0' - 118.0'

GRAIN SIZE DISTRIBUTION

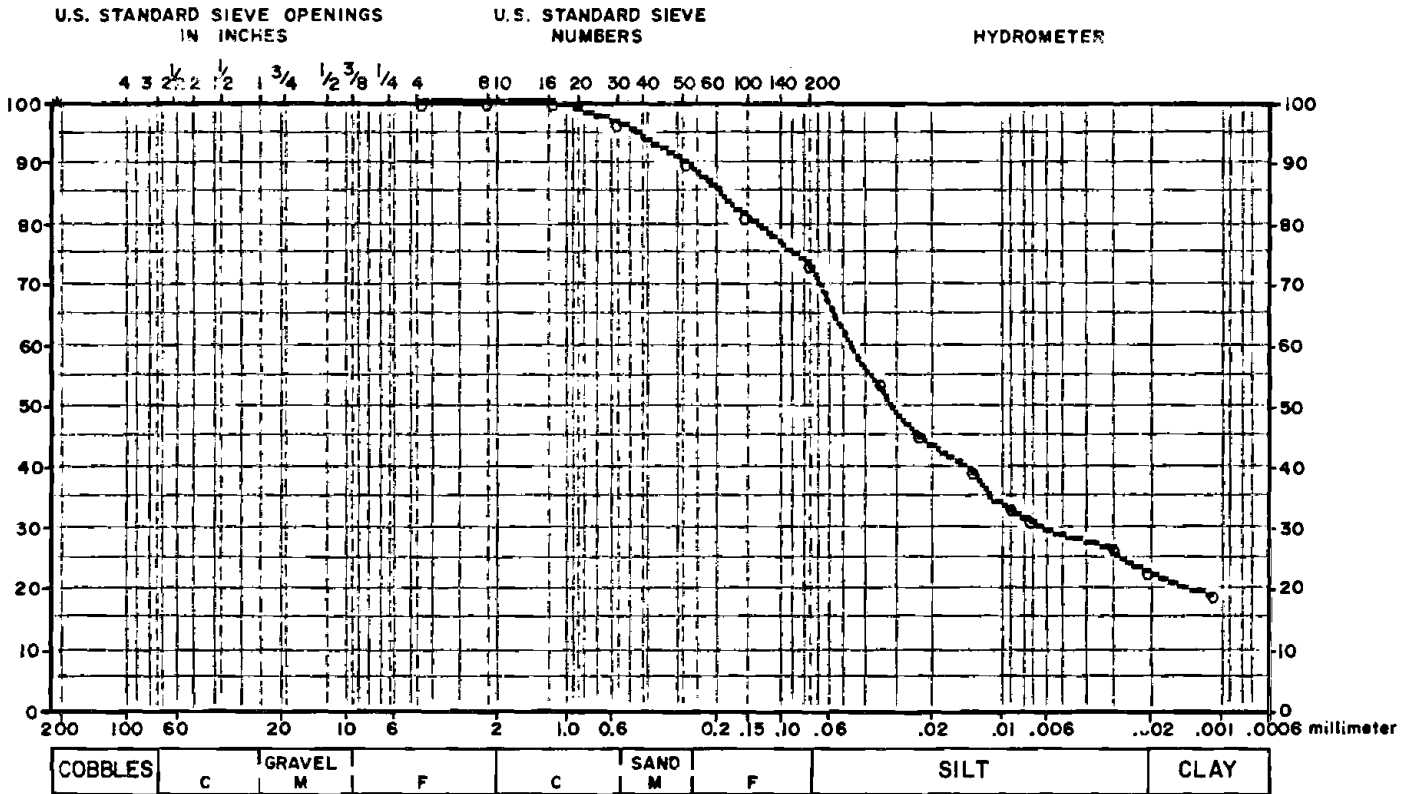

COARSE				FINE				HYDROMETER		
SIZE (Inches)	PERCENT RETAINED	CUMULATIVE PERCENT PASSING	SPECS.	SIEVE	PERCENT RETAINED	CUMULATIVE PERCENT PASSING	SPECS.	PARTICLE DIAMETER (mm)	PERCENT PASSING	SPECS.
-	0.00	0.00	-	4	0.00	100.00	-	.036	53.74	E hydro
-	0.00	0.00	-	8	.07	99.93	-	.023	45.47	Eom
-	0.00	0.00	-	16	.14	99.79	-	.013	39.27	Eom
-	0.00	0.00	-	30	3.14	96.65	-	.009	33.07	Eom
-	0.00	0.00	-	50	6.71	89.94	-	.007	31.00	Eom
-	0.00	0.00	-	100	8.28	81.66	-	.003	26.87	Eom
-	0.00	0.00	-	200	8.64	73.02	-	.002	22.74	Eom
-	0.00	0.00	-	-	0.00	0.00	-	.001	18.60	Eom

PAN = 73.0%
WASH LOSS WAS NOT TESTED.

SPECIFICATION: ASTM C 136 ASTM D 422

TEST STANDARD: NONE
NOTES: NONE

Test samples are retained for 30 days after submission and then discarded, unless other arrangements are made.

Dunn Geoscience Laboratory

5 Northway Lane North, Latham, NY 12110 (518) 783-8102

CLIENT: GENERAL ELECTRIC COMPANY NOTT STREET
 LAB NUMBER: 84-9-20/383-5-2973 DATE RECEIVED: 9/21/84
 TEST BY: JWH DATE TESTED: 9/25/84
 REVIEWED BY: *MJZ* DATE REPORTED: 10/1/84
 SAMPLE DESCR: TEST BORING DGC-161 S-1 24.0' - 26.0'

GRAIN SIZE DISTRIBUTION

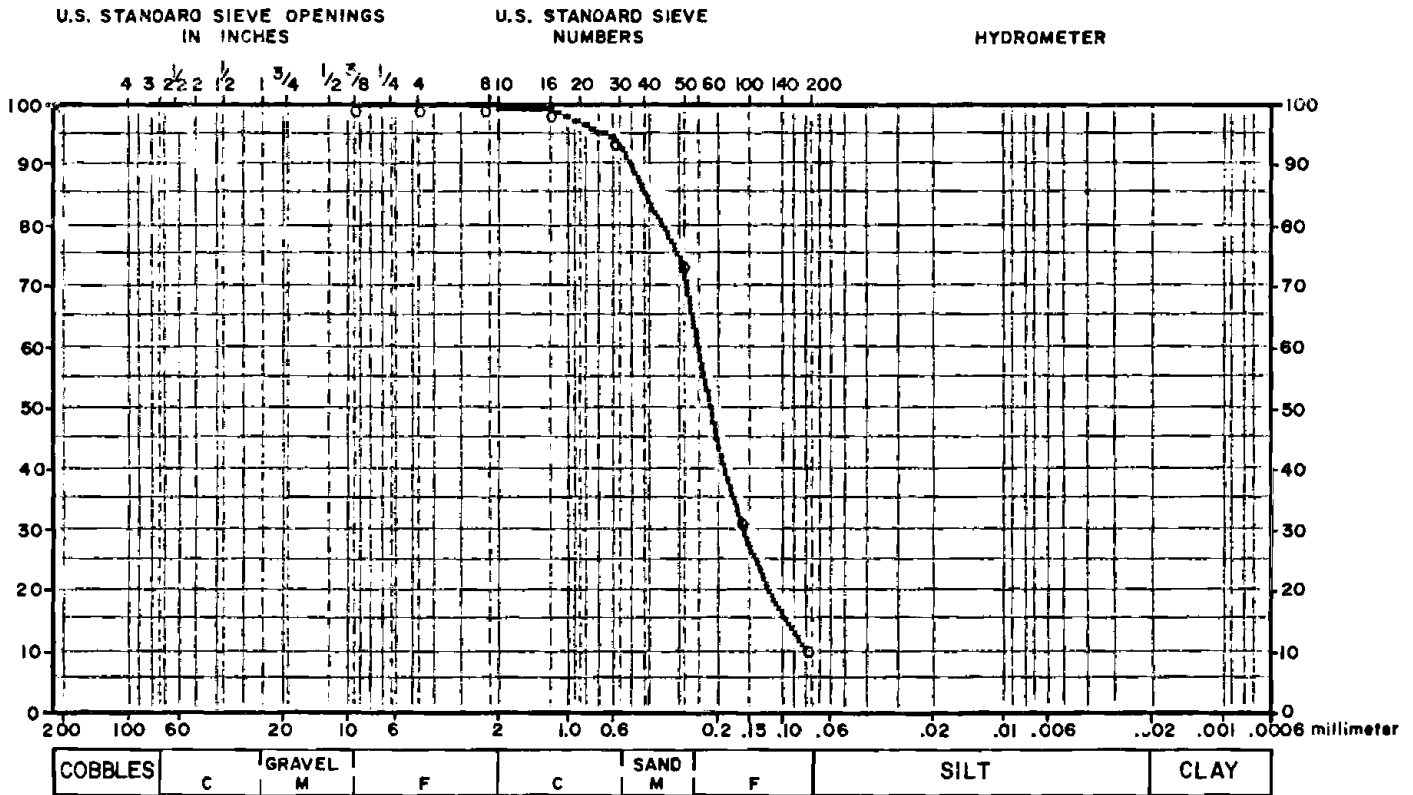

COARSE				FINE				HYDROMETER		
SIZE (Inches)	PERCENT RETAINED	CUMULATIVE PERCENT PASSING	SPECS.	SIEVE	PERCENT RETAINED	CUMULATIVE PERCENT PASSING	SPECS.	PARTICLE DIAMETER (mm)	PERCENT PASSING	SPECS.
-	0.00	0.00	-	3/8	0.00	100.00	-			
-	0.00	0.00	-	4	0.00	100.00	-			
-	0.00	0.00	-	8	.26	99.74	-			
-	0.00	0.00	-	16	.35	99.39	-			
-	0.00	0.00	-	30	4.97	94.42	-			
-	0.00	0.00	-	50	20.36	74.06	-			
-	0.00	0.00	-	100	42.08	31.97	-			
-	0.00	0.00	-	200	21.63	10.34	-			
-	0.00	0.00	-	-	0.00	0.00	-			
-	0.00	0.00	-	-	0.00	0.00	-			
-	0.00	0.00	-	-	0.00	0.00	-			
-	0.00	0.00	-	-	0.00	0.00	-			

PAN = 10.3%
 WASH LOSS WAS NOT TESTED.

SPECIFICATION: ASTM C 136

TEST STANDARD: NONE

NOTES: NONE

Test samples are retained for 30 days after submission and then discarded, unless other arrangements are made.

Dunn Geoscience Laboratory

5 Northway Lane North, Latham, NY 12110 (518) 783-8102

CLIENT: GENERAL ELECTRIC COMPANY NOTT STREET
 LAB NUMBER: 84-9-21/383-5-2973 DATE RECEIVED: 9/21/84
 TEST BY: JWH DATE TESTED: 9/25/84
 REVIEWED BY: *MJZ* DATE REPORTED: 10/1/84
 SAMPLE DESCR: TEST BORING DGC-181 S-1 39.0' - 41.0'

GRAIN SIZE DISTRIBUTION

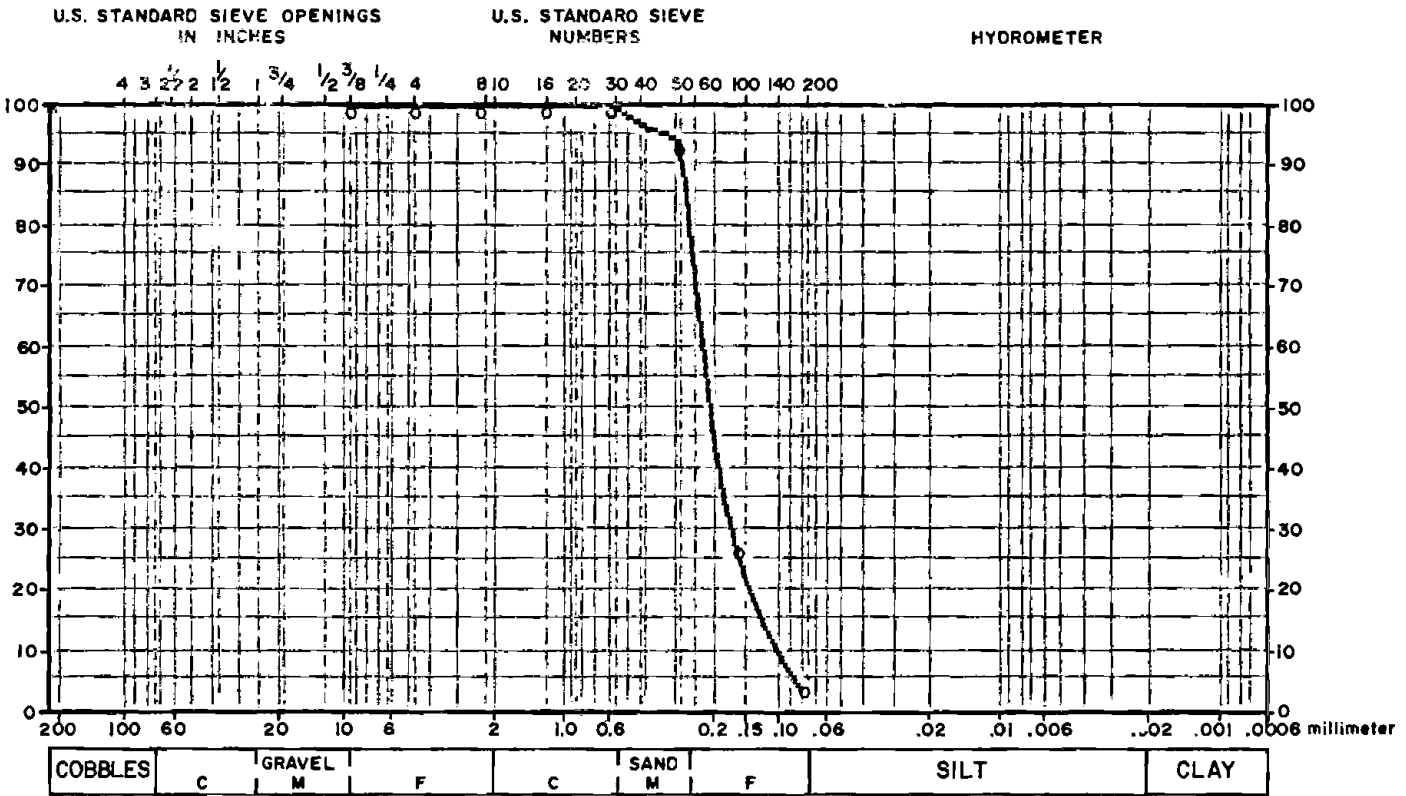

COARSE				FINE				HYDROMETER		
SIZE (inches)	PERCENT RETAINED	CUMULATIVE PERCENT PASSING	SPECS.	SIEVE	PERCENT RETAINED	CUMULATIVE PERCENT PASSING	SPECS.	PARTICLE DIAMETER (mm)	PERCENT PASSING	SPECS.
-	0.00	0.00	-	3/8	0.00	100.00	-			
-	0.00	0.00	-	4	0.00	100.00	-			
-	0.00	0.00	-	8	0.00	100.00	-			
-	0.00	0.00	-	16	0.00	100.00	-			
-	0.00	0.00	-	30	.14	99.86	-			
-	0.00	0.00	-	50	5.75	94.11	-			
-	0.00	0.00	-	100	66.99	27.12	-			
-	0.00	0.00	-	200	23.05	4.07	-			
-	0.00	0.00	-	-	0.00	0.00	-			
-	0.00	0.00	-	-	0.00	0.00	-			
-	0.00	0.00	-	-	0.00	0.00	-			
-	0.00	0.00	-	-	0.00	0.00	-			

PAN = 4.1%
 WASH LOSS WAS NOT TESTED.

SPECIFICATION: ASTM C 136

TEST STANDARD: NONE

NOTES: NONE

Test samples are retained for 30 days after submission and then discarded, unless other arrangements are made.

Dunn Geoscience Laboratory

5 Northway Lane North, Latham, NY 12110 (518) 783-8102

CLIENT: GENERAL ELECTRIC COMPANY NOTT STREET
 LAB NUMBER: 84-9-22/383-5-2973 DATE RECEIVED: 9/21/84
 TEST BY: JWH DATE TESTED: 9/25/84
 REVIEWED BY: *MJZ* DATE REPORTED: 10/1/84
 SAMPLE DESCR: TEST BORING DGC-19S S-9 40.0' - 42.0'

GRAIN SIZE DISTRIBUTION

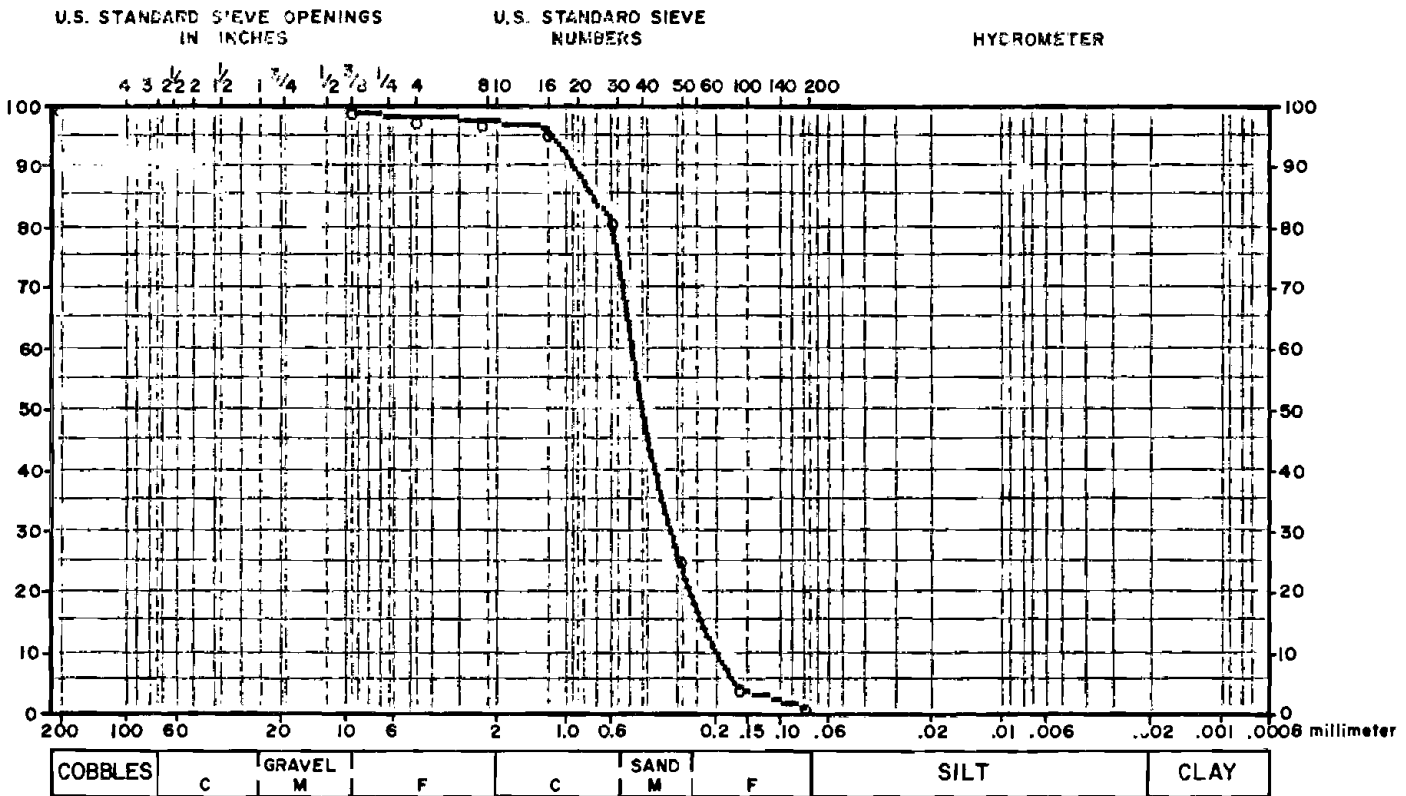

COARSE				FINE				HYDROMETER		
SIZE (inches)	PERCENT RETAINED	CUMULATIVE PERCENT PASSING	SPECS.	SIEVE	PERCENT RETAINED	CUMULATIVE PERCENT PASSING	SPECS.	PARTICLE DIAMETER (mm)	PERCENT PASSING	SPECS.
-	0.00	0.00	-	3/8	0.00	100.00	-			
-	0.00	0.00	-	4	1.48	98.52	-			
-	0.00	0.00	-	8	.24	98.29	-			
-	0.00	0.00	-	16	1.42	96.87	-			
-	0.00	0.00	-	30	15.10	81.77	-			
-	0.00	0.00	-	50	56.01	25.76	-			
-	0.00	0.00	-	100	20.89	4.87	-			
-	0.00	0.00	-	200	3.43	1.45	-			
-	0.00	0.00	-	-	0.00	0.00	-			
-	0.00	0.00	-	-	0.00	0.00	-			
-	0.00	0.00	-	-	0.00	0.00	-			
-	0.00	0.00	-	-	0.00	0.00	-			

PAN = 1.4%
 WASH LOSS WAS NOT TESTED.

SPECIFICATION: ASTM C 136

TEST STANDARD: NONE

NOTES: NONE

Test samples are retained for 30 days after submission and then discarded, unless other arrangements are made.

Dunn Geoscience Laboratory

5 Northway Lane North, Latham, NY 12110 (518) 783-8102

CLIENT: GENERAL ELECTRIC COMPANY
 LAB NUMBER: 84-9-17/383-5-2973 DATE RECEIVED: 9/21/84
 TEST BY: JWH DATE TESTED: 9/24/84
 REVIEWED BY: *MJZ* DATE REPORTED: 9/27/84
 SAMPLE DESCR: TEST BORING DGC-20 S-12 55.0' - 57.0'

GRAIN SIZE DISTRIBUTION

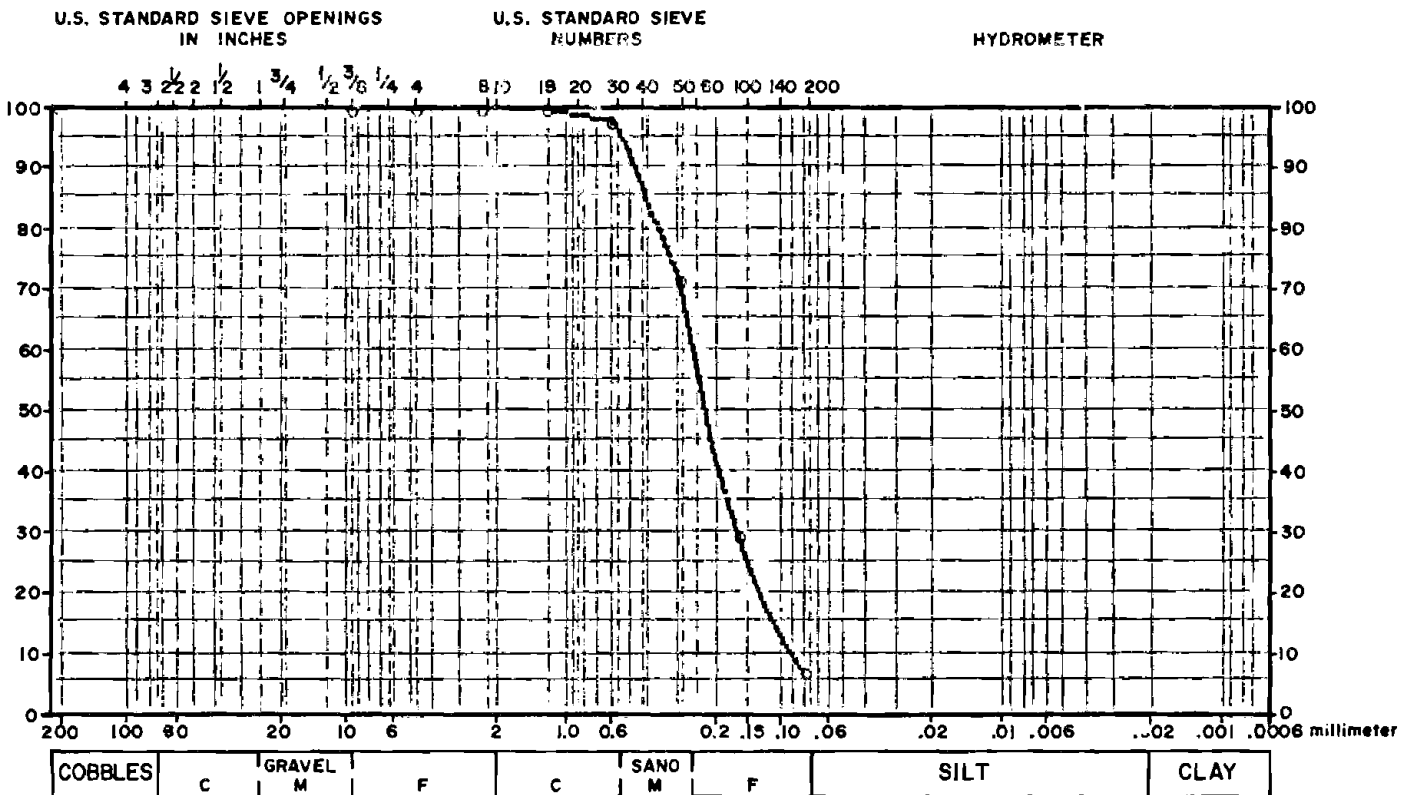

COARSE				FINE				HYDROMETER		
SIZE (Inches)	PERCENT RETAINED	CUMULATIVE PERCENT PASSING	SPECS.	SIEVE	PERCENT RETAINED	CUMULATIVE PERCENT PASSING	SPECS.	PARTICLE DIAMETER (mm)	PERCENT PASSING	SPECS.
-	0.00	0.00	-	3/8	0.00	100.00	-			
-	0.00	0.00	-	4	.05	99.95	-			
-	0.00	0.00	-	8	.20	99.75	-			
-	0.00	0.00	-	16	.07	99.68	-			
-	0.00	0.00	-	30	1.94	97.73	-			
-	0.00	0.00	-	50	25.61	72.12	-			
-	0.00	0.00	-	100	42.33	29.80	-			
-	0.00	0.00	-	200	22.72	7.08	-			
-	0.00	0.00	-	-	0.00	0.00	-			
-	0.00	0.00	-	-	0.00	0.00	-			
-	0.00	0.00	-	-	0.00	0.00	-			
-	0.00	0.00	-	-	0.00	0.00	-			

PAN = 7.1%
 WASH LOSS WAS NOT TESTED.

SPECIFICATION: ASTM C136

TEST STANDARD: NONE

NOTES: NONE

Test samples are retained for 30 days after submission and then discarded, unless other arrangements are made.

Dunn Geoscience Laboratory

5 Northway Lane North, Latham, NY 12110 (518) 783-8102

CLIENT: GENERAL ELECTRIC COMPANY
 LAB NUMBER: 84-9-18/383-5-2973 DATE RECEIVED: 9/21/84
 TEST BY: JWH DATE TESTED: 9/25/84
 REVIEWED BY: *MGZ* DATE REPORTED: 9/28/84
 SAMPLE DESCR: TVSD BORING DGC-20 S-19 90.0' - 92.0'

GRAIN SIZE DISTRIBUTION

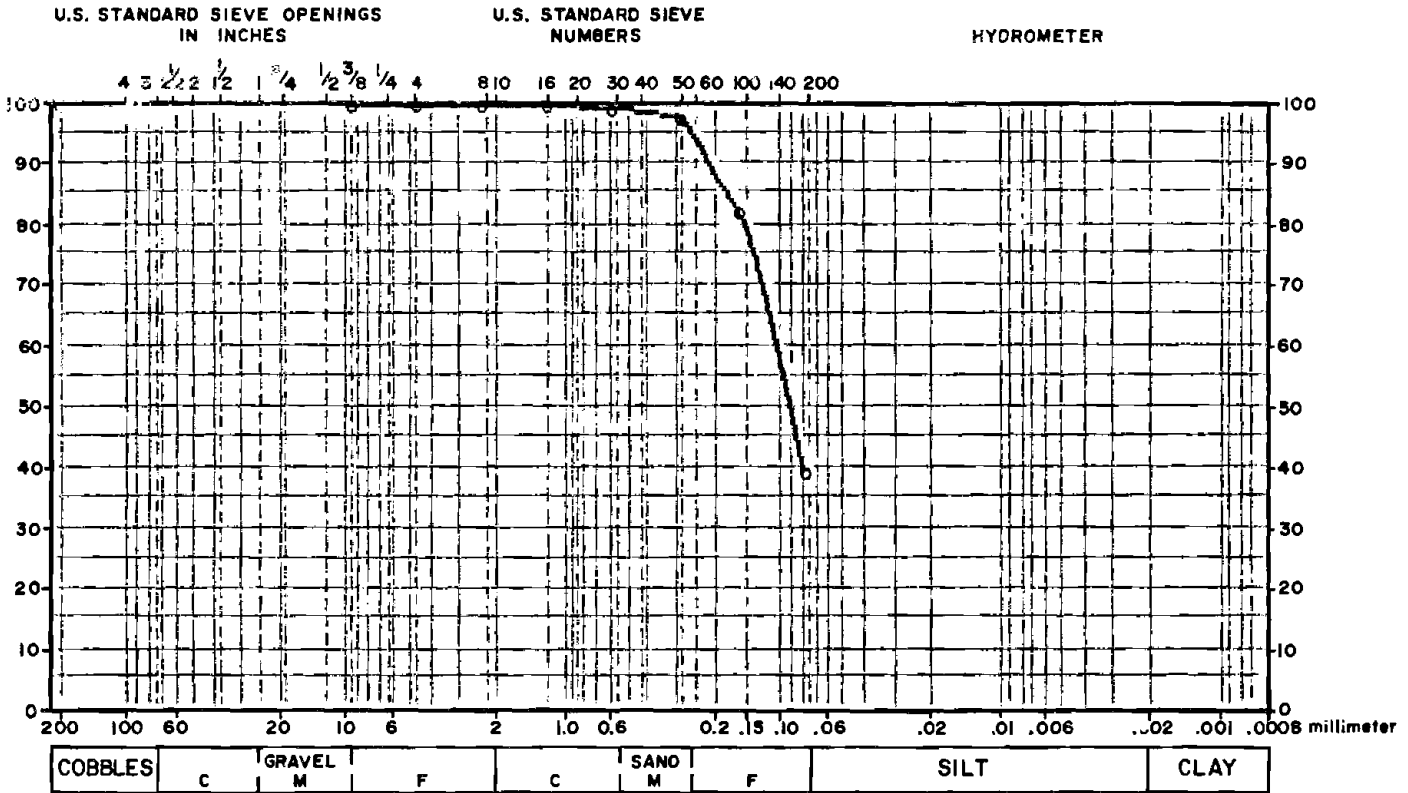

COARSE				FINE				HYDROMETER		
SIZE (inches)	PERCENT RETAINED	CUMULATIVE PERCENT PASSING	SPECS.	SIEVE	PERCENT RETAINED	CUMULATIVE PERCENT PASSING	SPECS.	PARTICLE DIAMETER (mm)	PERCENT PASSING	SPECS.
-	0.00	0.00	-	3/8	0.00	100.00	-			
-	0.00	0.00	-	4	0.00	100.00	-			
-	0.00	0.00	-	8	.07	99.93	-			
-	0.00	0.00	-	16	.10	99.83	-			
-	0.00	0.00	-	30	.30	99.53	-			
-	0.00	0.00	-	50	1.64	97.89	-			
-	0.00	0.00	-	100	15.39	82.50	-			
-	0.00	0.00	-	200	42.92	39.58	-			
-	0.00	0.00	-	-	0.00	0.00	-			
-	0.00	0.00	-	-	0.00	0.00	-			
-	0.00	0.00	-	-	0.00	0.00	-			
-	0.00	0.00	-	-	0.00	0.00	-			

PAN = 39.6%
 WASH LOSS WAS NOT TESTED.

SPECIFICATION: ASTM C 136

TEST STANDARD: NONE
 NOTES: NONE

Test samples are retained for 30 days after submission
 and then discarded, unless other arrangements are made.

Dunn Geoscience Laboratory

5 Northway Lane North, Latham, NY 12110 (518) 783-8102

CLIENT: GENERAL ELECTRIC COMPANY NOTT STREET
 LAB NUMBER: 84-9-19/383-5-2973 DATE RECEIVED: 9/21/84
 TEST BY: JWH DATE TESTED: 9/25/84
 REVIEWED BY: *MJZ* DATE REPORTED: 10/1/84
 SAMPLE DESCR: TEST BORING DGC-20 S-21 100.0' - 102.0'

GRAIN SIZE DISTRIBUTION

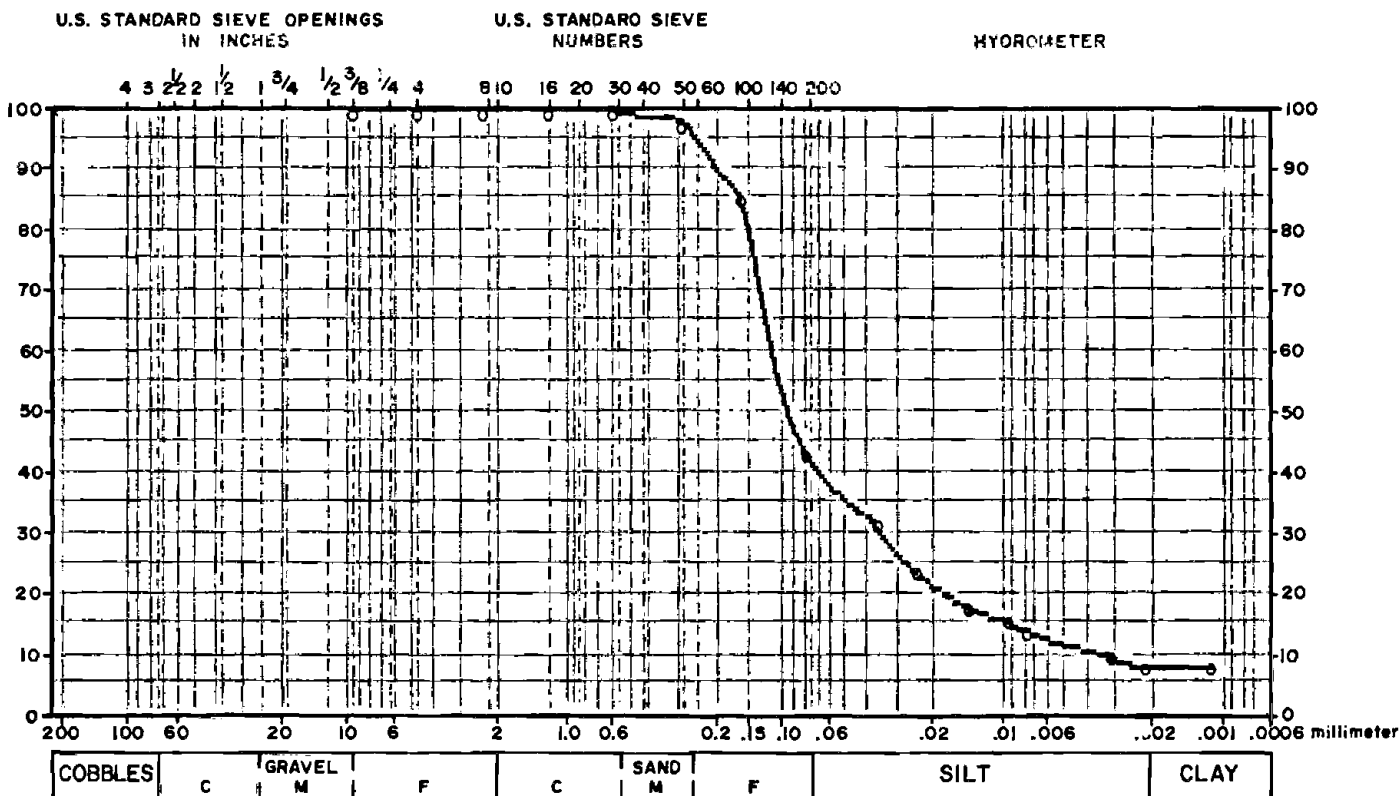

COARSE				FINE				HYDROMETER		
SIZE (Inches)	PERCENT RETAINED	CUMULATIVE PERCENT PASSING	SPECS.	SIEVE	PERCENT RETAINED	CUMULATIVE PERCENT PASSING	SPECS.	PARTICLE DIAMETER (mm)	PERCENT PASSING	SPECS.
-	0.00	0.00	-	3/8	0.00	100.00	-	.036	31.75	-
-	0.00	0.00	-	4	0.00	100.00	-	.023	23.81	-
-	0.00	0.00	-	8	0.00	100.00	-	.013	17.86	-
-	0.00	0.00	-	16	0.00	100.00	-	.009	15.87	-
-	0.00	0.00	-	30	.27	99.73	-	.007	13.89	-
-	0.00	0.00	-	50	1.66	98.07	-	.003	9.92	-
-	0.00	0.00	-	100	12.12	85.95	-	.002	7.94	-
-	0.00	0.00	-	200	42.70	43.24	-	.001	7.94	-

PAN = 43.2%
 WASH LOSS WAS NOT TESTED.

SPECIFICATION: ASTM C 136 ASTM D 422

TEST STANDARD: NONE

NOTES: NONE

Test samples are retained for 30 days after submission and then discarded, unless other arrangements are made.

Dunn Geoscience Laboratory

5 Northway Lane North, Latham, NY 12110 (518) 783-8102

CLIENT: GENERAL ELECTRIC COMPANY NOTT STREET
 LAB NUMBER: 84-9-23/383-5-2973 DATE RECEIVED: 9/21/84
 TEST BY: JWH DATE TESTED: 9/25/84
 REVIEWED BY: *MJZ* DATE REPORTED: 10/1/84
 SAMPLE DESCR: TEST BORING DGC-21 S-14 65.0' - 67.0'

GRAIN SIZE DISTRIBUTION

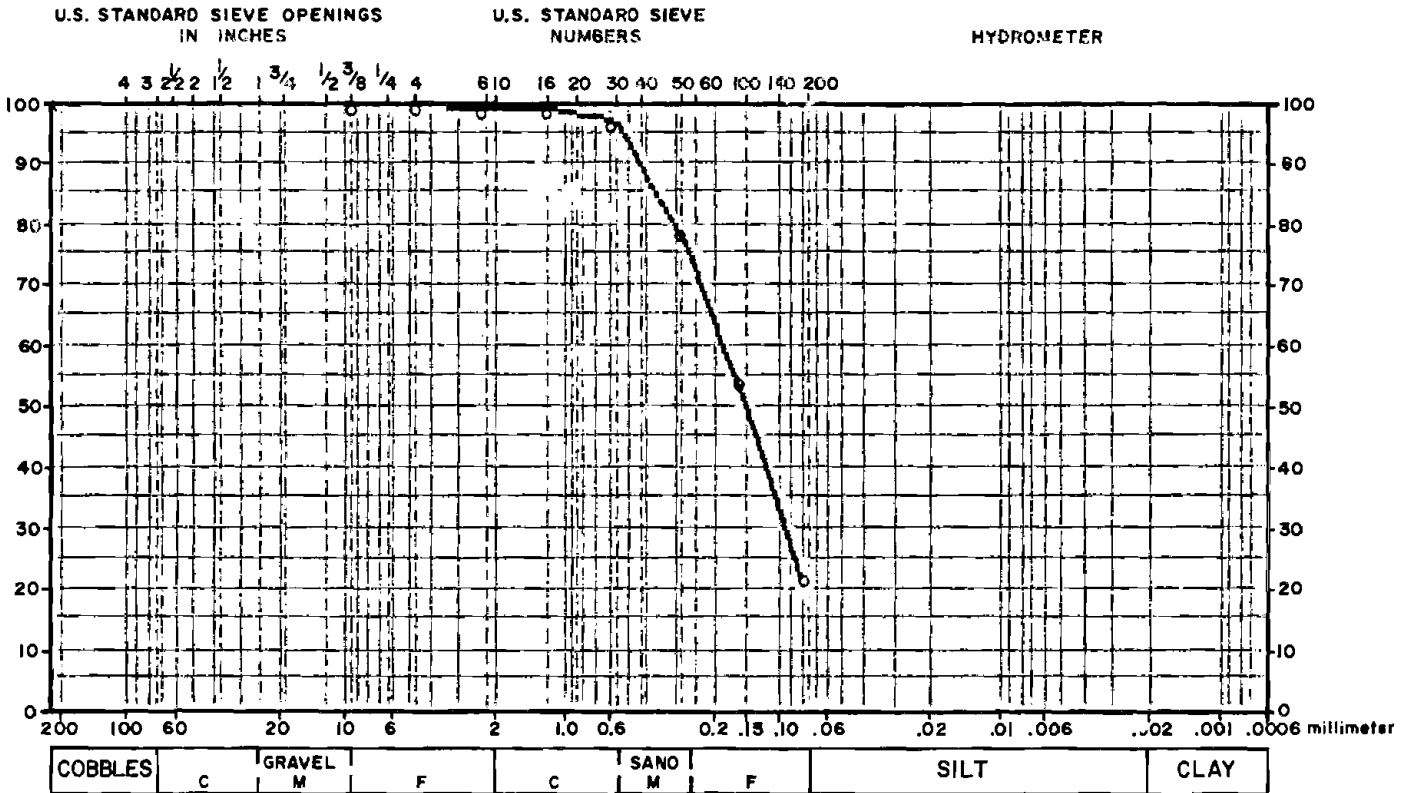

COARSE				FINE				HYDROMETER		
SIZE (inches)	PERCENT RETAINED	CUMULATIVE PERCENT PASSING	SPECS.	SIEVE	PERCENT RETAINED	CUMULATIVE PERCENT PASSING	SPECS.	PARTICLE DIAMETER (mm)	PERCENT PASSING	SPECS.
-	0.00	0.00	-	3/8	0.00	100.00	-	-	-	-
-	0.00	0.00	-	4	.22	99.78	-	-	-	-
-	0.00	0.00	-	8	.22	99.56	-	-	-	-
-	0.00	0.00	-	16	.18	99.38	-	-	-	-
-	0.00	0.00	-	30	1.94	97.44	-	-	-	-
-	0.00	0.00	-	50	17.98	79.46	-	-	-	-
-	0.00	0.00	-	100	24.61	54.85	-	-	-	-
-	0.00	0.00	-	200	32.68	22.17	-	-	-	-
-	0.00	0.00	-	-	0.00	0.00	-	-	-	-
-	0.00	0.00	-	-	0.00	0.00	-	-	-	-
-	0.00	0.00	-	-	0.00	0.00	-	-	-	-
-	0.00	0.00	-	-	0.00	0.00	-	-	-	-

PAN = 22.2%
 WASH LOSS WAS NOT TESTED.

SPECIFICATION: ASTM C 136

TEST STANDARD: NONE

NOTES: NONE

Test samples are retained for 30 days after submission and then discarded, unless other arrangements are made.

Dunn Geoscience Laboratory

5 Northway Lane North, Latham, NY 12110 (518) 783-8102

CLIENT: GENERAL ELECTRIC COMPANY NOTT STREET
 LAB NUMBER: 84-9-24/383-5-2973 DATE RECEIVED: 9/21/84
 TEST BY: JWH DATE TESTED: 9/25/84
 REVIEWED BY: *MJZ* DATE REPORTED: 10/1/84
 SAMPLE DESCR: TEST BORING DGC-21 S-21 100.0' - 102.0'

GRAIN SIZE DISTRIBUTION

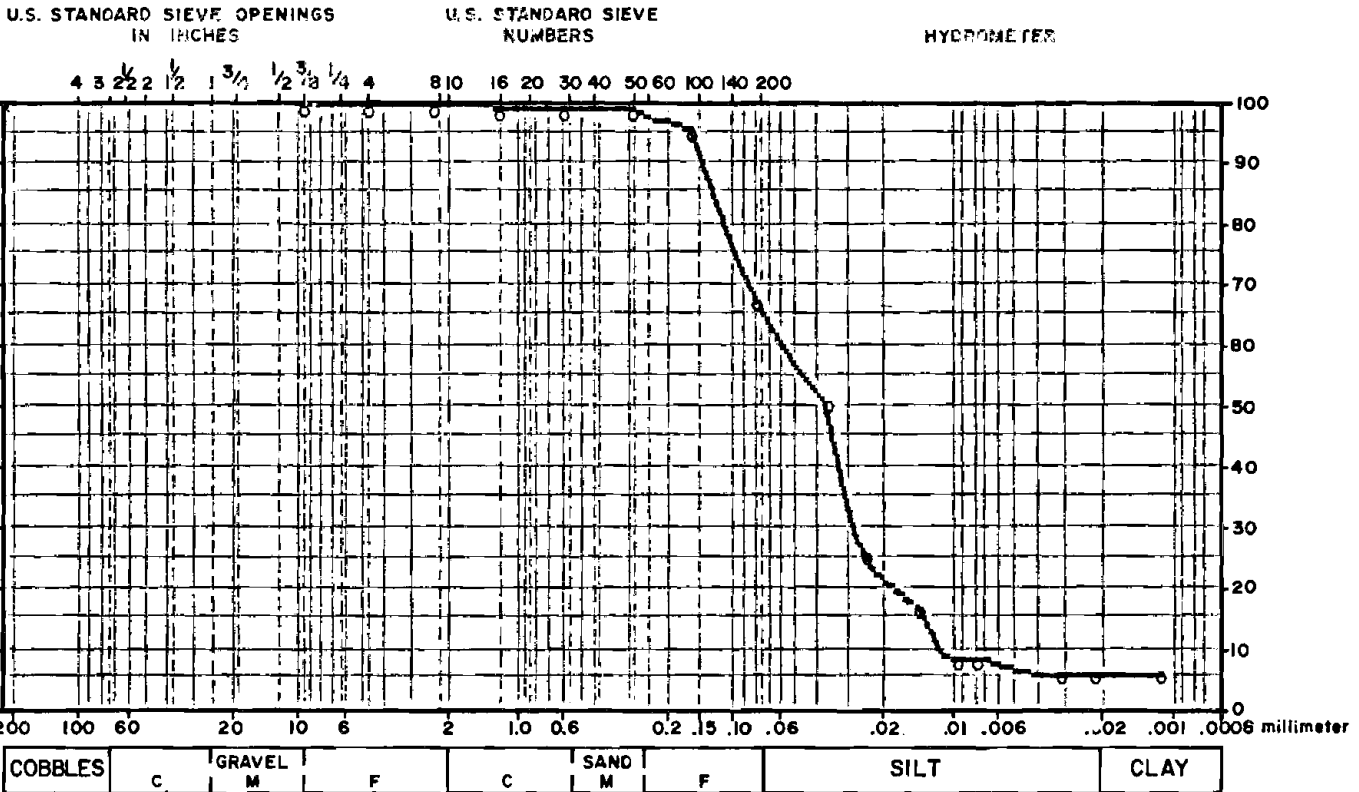

COARSE

FINE

HYDROMETER

SIZE (inches)	PERCENT RETAINED	CUMULATIVE PERCENT PASSING	SPECS.
---------------	------------------	----------------------------	--------

SIEVE	PERCENT RETAINED	CUMULATIVE PERCENT PASSING	SPECS.
-------	------------------	----------------------------	--------

PARTICLE DIAMETER (mm)	PERCENT PASSING	SPECS.
------------------------	-----------------	--------

-	0.00	0.00	-	3/8	0.00	100.00	-	.036	51.44	-
-	0.00	0.00	-	4	0.00	100.00	-	.023	25.72	-
-	0.00	0.00	-	8	.06	99.94	-	.013	17.15	-
-	0.00	0.00	-	16	.33	99.61	-	.009	8.57	-
-	0.00	0.00	-	30	.28	99.33	-	.007	8.57	-
-	0.00	0.00	-	50	.28	99.05	-	.003	5.71	-
-	0.00	0.00	-	100	3.23	95.83	-	.002	5.71	-
-	0.00	0.00	-	200	27.99	67.84	-	.001	5.71	-

PAN = 67.8%

WASH LOSS WAS NOT TESTED.

SPECIFICATION: ASTM C 136

ASTM D 422

TEST STANDARD: NONE

NOTES: NONE

Test samples are retained for 30 days after submission and then discarded, unless other arrangements are made.

Dunn Geoscience Laboratory

5 Northway Lane North, Latham, NY 12110 (518) 783-8102

CLIENT: GENERAL ELECTRIC COMPANY NOTT STREET
 LAB NUMBER: 84-9-25/383-5-2973 DATE RECEIVED: 9/21/84
 TEST BY: JWH DATE TESTED: 9/24/84
 REVIEWED BY: *MJZ* DATE REPORTED: 10/1/84
 SAMPLE DESCR: TEST BORING DGC-22 S-8 35.0' - 37.0'

GRAIN SIZE DISTRIBUTION

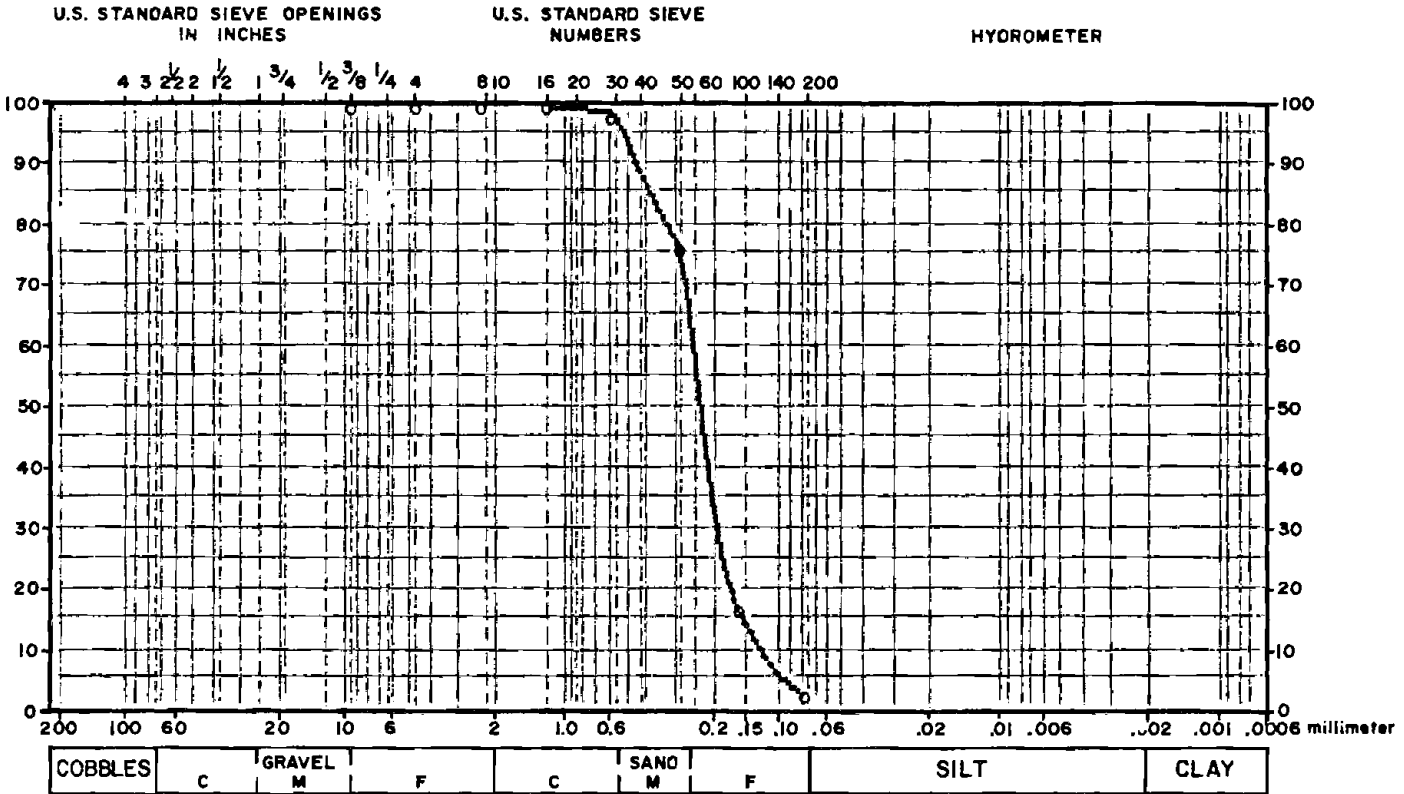

COARSE				FINE				HYDROMETER		
SIZE (inches)	PERCENT RETAINED	CUMULATIVE PERCENT PASSING	SPECS.	SIEVE	PERCENT RETAINED	CUMULATIVE PERCENT PASSING	SPECS.	PARTICLE DIAMETER (mm)	PERCENT PASSING	SPECS.
-	0.00	0.00	-	3/8	0.00	100.00	-			
-	0.00	0.00	-	4	0.00	100.00	-			
-	0.00	0.00	-	8	0.00	100.00	-			
-	0.00	0.00	-	16	.31	99.69	-			
-	0.00	0.00	-	30	.98	98.71	-			
-	0.00	0.00	-	50	22.08	76.63	-			
-	0.00	0.00	-	100	59.39	17.23	-			
-	0.00	0.00	-	200	14.84	2.39	-			
-	0.00	0.00	-	-	0.00	0.00	-			
-	0.00	0.00	-	-	0.00	0.00	-			
-	0.00	0.00	-	-	0.00	0.00	-			
-	0.00	0.00	-	-	0.00	0.00	-			

PAN = 2.4%
 WASH LOSS WAS NOT TESTED.

SPECIFICATION: ASTM C 136

TEST STANDARD: NONE
 NOTES: NONE

Test samples are retained for 30 days after submission and then discarded, unless other arrangements are made.