



Amphenol
Products

Robb

Bendix Connector Operations
40-60 Delaware Street
Sidney, NY 13838-1395

March 5, 1987

Mr. Eldred Rich, P.E.
New York State Department of
Environmental Conservation
Region IV Headquarters
2176 Guilderland Avenue
Schenectady, New York 12306

Re: R.I. Study - West Well and West Parking Lot
Amphenol Corporation-Bendix Connector Operations
Sidney, New York

Dear Mr. Rich:

Transmitted herewith are seven (7) copies of our responses to the NYSDEC comments on the "Hydrogeologic and Soils Investigation at the West Well and West Parking Lot" report.

We have a draft report prepared addressing the various remedial alternatives available for this project. It is expected that the report will be ready for submission in 3 to 4 weeks. We would therefore appreciate your expedient review of this submission to enable the project to progress to the remedial stage. If the submission is acceptable, please provide your written approval. Thank you for your cooperation and assistance.

Very truly yours,

A handwritten signature in cursive script that reads "Henry J. Mitchell".

Henry J. Mitchell, Manager
Facilities Engineering

/vt

Encl.

AMPHENOL corporation

an *LPL* company

(607) 563-5011

F. Hamilton
Ted

RECEIVED
MAR 2 1988
N.Y. STATE DEPT. OF
ENVIRONMENTAL CONSERVATION
REGION 4 OFFICE

February 26, 1988

Mr. Anthony Adamczyk, P.E.
Regional Water Engineer
New York State Department of
Environmental Conservation
2176 Guilderland Avenue
Schenectady, New York 12306

Re: West Well Air Stripping System
Amphenol Corporation - Bendix Connector Operations
Sidney, New York

Dear Mr. Adamczyk:

Please accept this letter as our request for your approval to begin operation of our west well air stripping system. An air permit application has been submitted to Mr. Bruce VanHouten in the DEC-Stamford office. In addition, the water discharge from the air stripper through the overflow of the west well reservoir has been covered in the SPDES permit (NY0003824) reapplication package submitted on January 20, 1988 to Mr. Jeffrey Sama, Regional Permit Administrator. This package is a follow-up submittal to our original permit reapplication made on August 10, 1987. An Industrial Chemical Survey form was also submitted to support the reapplication process on October 28, 1987.

We hope this information is sufficient for you to grant written authorization for system start-up. If any further information is required, please contact Mr. Wayne F. Barto, P.E. at our facility (607) 563-5506. Thank you for your continued assistance on this project.

Very truly yours,

Henry J. Mitchell

Henry J. Mitchell, Manager
Facilities Engineering

WFB/vt

cc: Mr. Richard Baldwin
Mr. Eldred Rich



**Amphenol
Products**

Bendix Connector Operations
40-60 Delaware Street
Sidney, NY 13838-1395

March 5, 1987

Mr. Eldred Rich, P.E.
New York State Department of
Environmental Conservation
Region IV Headquarters
2176 Guilderland Avenue
Schenectady, New York 12306

Re: R.I. Study - West Well and West Parking Lot
Amphenol Corporation-Bendix Connector Operations
Sidney, New York

Dear Mr. Rich:

Transmitted herewith are seven (7) copies of our responses to the NYSDEC comments on the "Hydrogeologic and Soils Investigation at the West Well and West Parking Lot" report.

We have a draft report prepared addressing the various remedial alternatives available for this project. It is expected that the report will be ready for submission in 3 to 4 weeks. We would therefore appreciate your expedient review of this submission to enable the project to progress to the remedial stage. If the submission is acceptable, please provide your written approval. Thank you for your cooperation and assistance.

Very truly yours,

Henry J. Mitchell, Manager
Facilities Engineering

/vt

Encl.

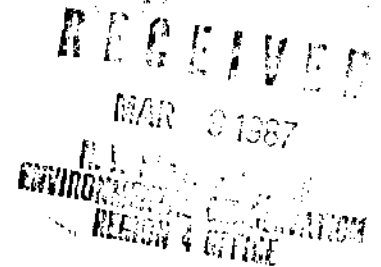

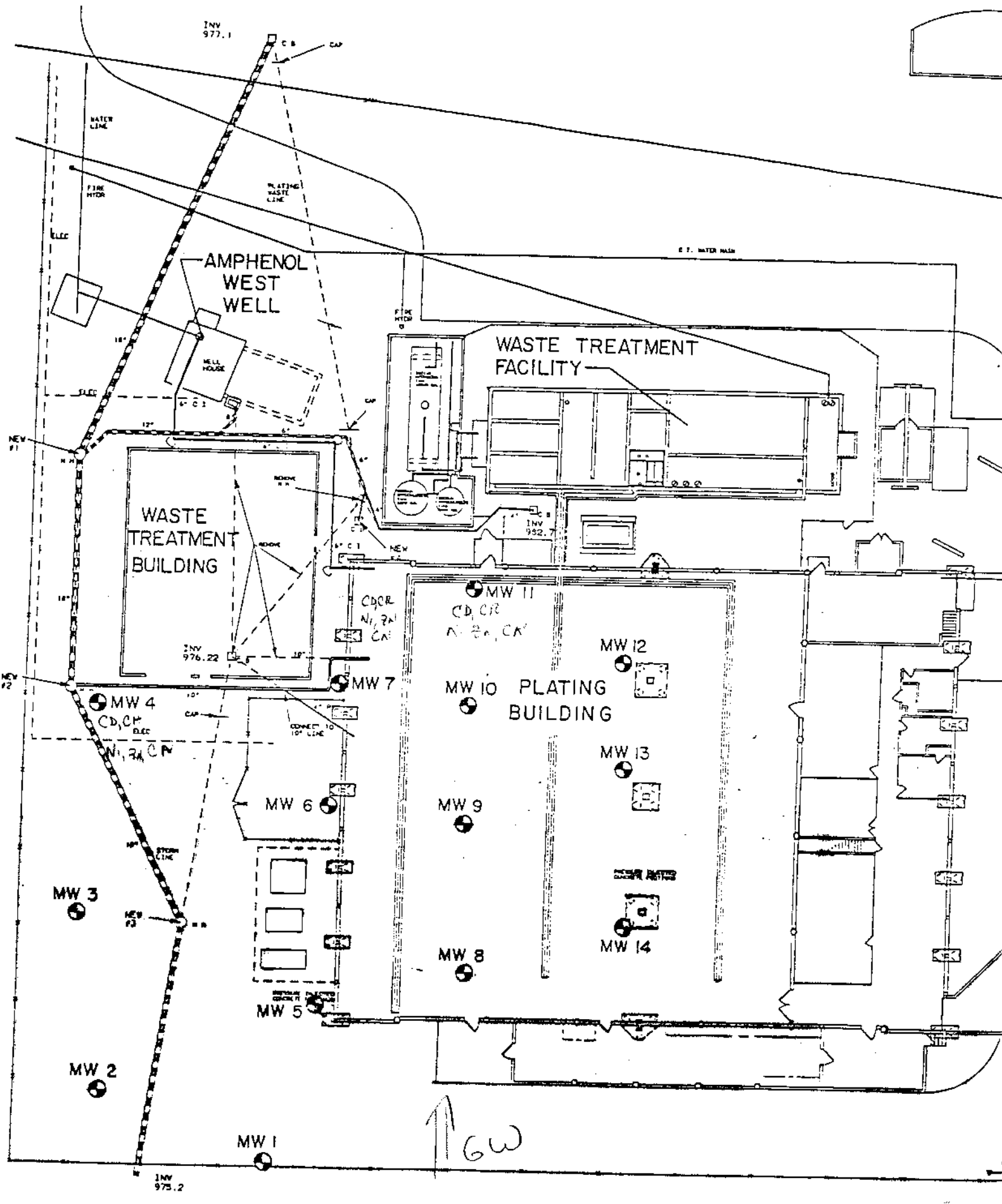

Figure 1-5 Tributary 147 Surface Water Samples

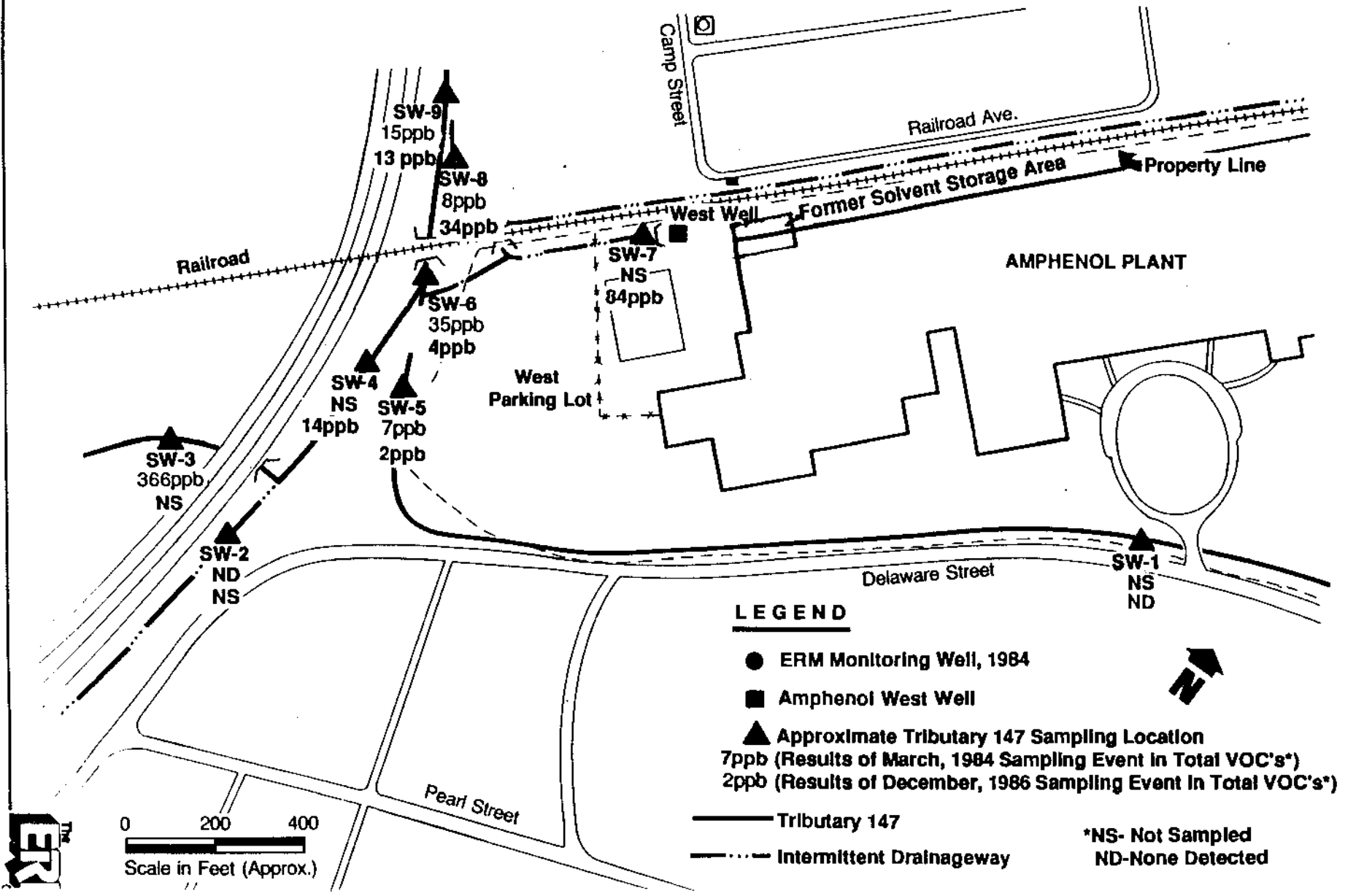

Figure 1-4 Locations of Tributary 147 Sediment Samples

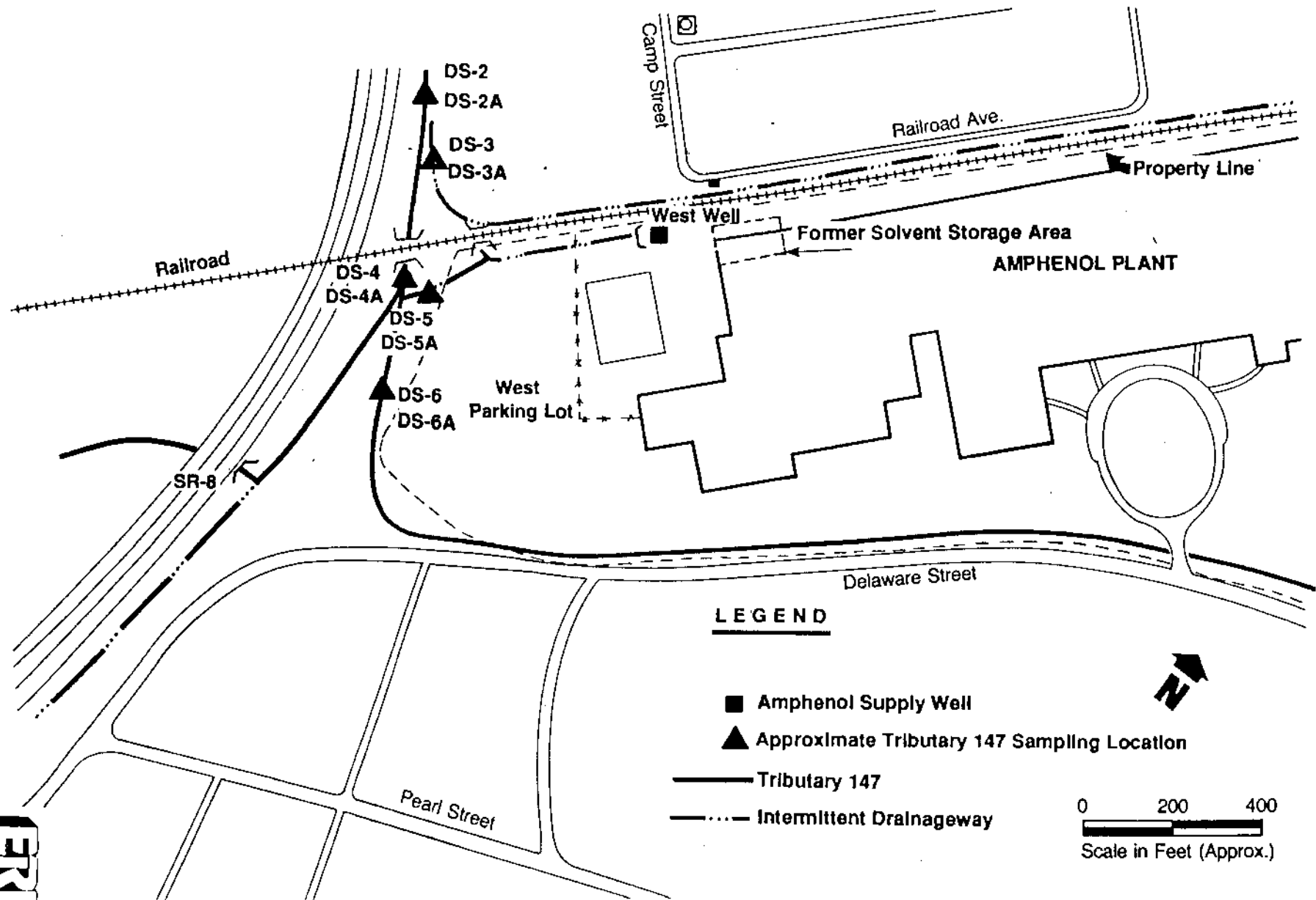
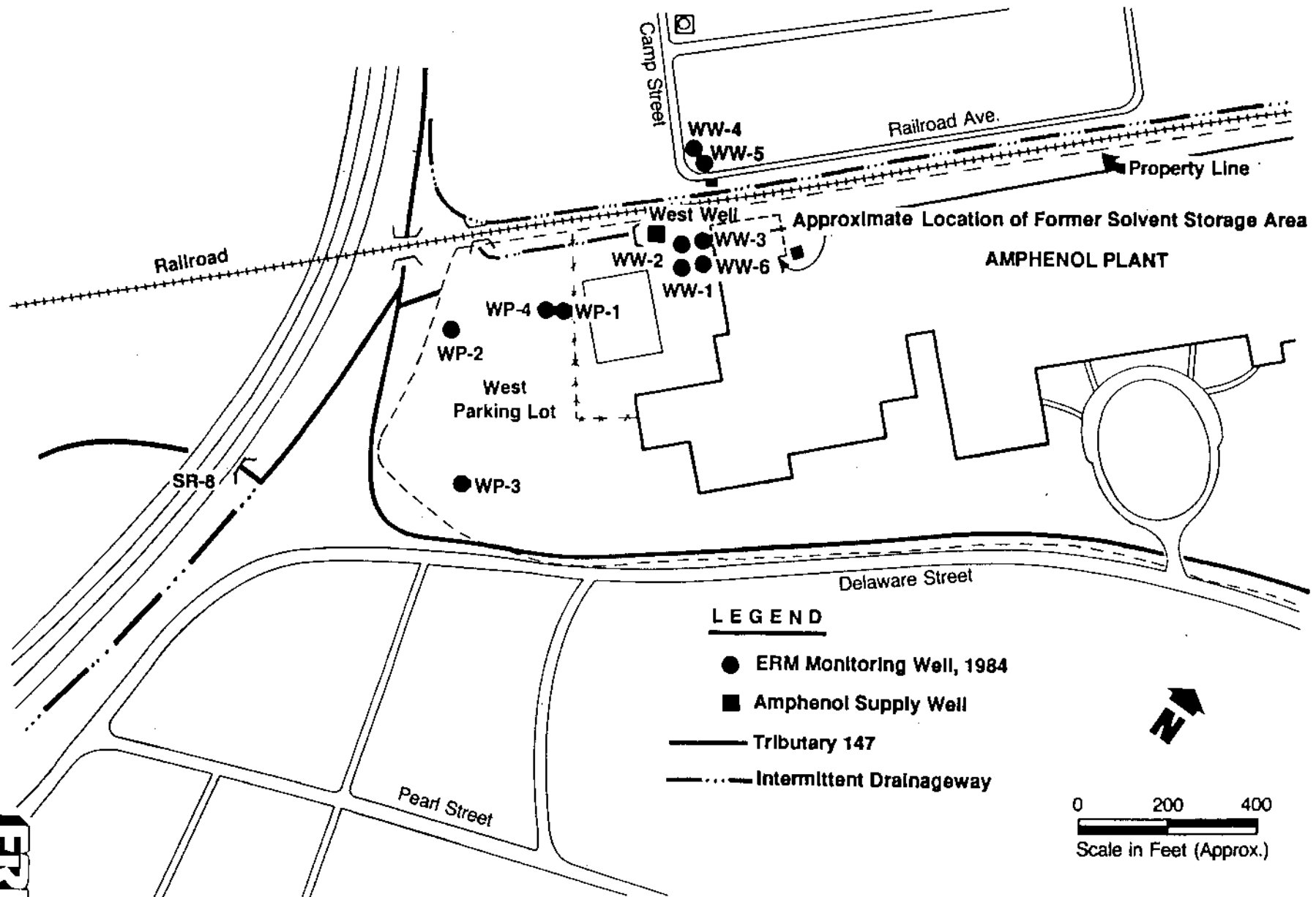

Figure 1-1 General Site Map and Locations of Monitoring Wells



1-2



West Parking Lot - Soil Samples PCB'S

SS-1 - ND
SS-1A - ND
SS-2 - ND

SS-2A - 85 ppm PCB (12" depth)

SS-3 - ND

SS-3A - 6 ppm PCB (12" depth)

SS-4 - ND

SS-4A - ND

Drainage Line Water Samples

VOC'S

DW-2 15 ppb

DW-3 8 ppb

DW-4 14 ppb

DW-6 7 ppb

Drainage Line Sediment Samples

PCB'S

DS-2 2 ppm

DS-2A 2 ppm

DS-3 ND

DS-3A ND

DS-4 1 ppm

DS-4A 1 ppm

DS-5 4 ppm

DS-5A ND

DS-6 ND

DS-6A 3 ppm

June 23rd
E.P.L.

File: 301-11

ALTERNATIVES FOR REMEDIATION -
WEST WELL AND WEST PARKING LOT AREA

18 May 1987

Prepared For:

Amphenol Corporation
Sidney, New York

Prepared By:

Environmental Resources Management, Inc.
999 West Chester Pike
West Chester, Pennsylvania 19382

TABLE OF CONTENTS

	<u>Page</u>
Section 1 - Introduction	1-1
1.1 - Background	1-1
1.2 - Potential Source Areas	1-1
1.3 - Summary of Investigations	1-3
1.4 - Conclusions	1-18
1.5 - Objectives of Remediation	1-19
Section 2 - Site Impact Assessment/Remedial Requirements	2-1
2.1 - Site Impact Assessment	2-1
2.2 - Ground Water	2-2
2.3 - Soils/Sediments	2-9
2.4 - Surface Water	2-11
2.5 - Proposed Remedial Actions	2-12
Section 3 - Ground Water Treatment	3-1
3.1 - Introduction and Statement of Objectives	3-1
3.2 - Treatment Alternatives	3-3
3.3 - Air Stripping Process Description	3-3
3.4 - Design Conditions	3-6
3.5 - Design Procedures	3-8
3.6 - Recommended Design of Air Stripper	3-12
3.7 - Air Emission Analysis	3-13
3.8 - Physical Layout	3-15
Section 4 - Conclusions and Recommendations	4-1
4.1 - Conclusions	4-1
4.2 - Recommendations	4-2

LIST OF FIGURES

<u>Figure</u>		<u>Page</u>
1-1	General Site Map and Locations of Monitoring Wells	1-2
1-2	Cone of Depression Deep Flow Zone February 22, 1985	1-9
1-3	Locations of Soil Samples in West Parking Lot	1-11
1-4	Locations of Tributary 147 Sediment Samples	1-14
1-5	Tributary 147 Surface Water Samples	1-15
3-1	Amphenol Corporation - Bendix Connector Operations - Present Service Schematic	3-2
3-2	Amphenol Corporation - Bendix Connector Operations - Air Stripper Service Schematic	3-17
3-3	Amphenol Corporation - Bendix Connector Operations - West Well Plan View	3-19
3-4	Amphenol Corporation - Bendix Connector Operations - West Well Section "AA"	3-20

LIST OF TABLES

<u>Table</u>		<u>Page</u>
1-1	Summary of Analytical Results for Ground Water From West Well Area	1-5
1-2	Summary of Analytical Results for Soils/Sediment	1-12
1-3	Surface Water Sampling Locations	1-16
1-4	Summary of Analytical Results for Surface Water of Tributary 147	1-17
2-1	Regulatory Criteria for Site Evaluation	2-3
2-2	Summary of 1985 and 1986 Analytical Results for Shallow Ground Water	2-4
2-3	Summary of Analytical Results for Deep Ground Water	2-7
3-1	West Well Inorganic Analyses	3-4
3-2	West Well Ground Water Quality Summary	3-7
3-3	Design Basis	3-9
3-4	Design Summary	3-10
3-5	Air Emission Analyses	3-14
3-6	Equipment List	3-21

SECTION 1

INTRODUCTION

1.1 Background

ERM has been retained by Amphenol Corporation - Bendix Connector Operations (formerly the Bendix Corporation), Sidney, New York to conduct an assessment of the source and extent of volatile organic compounds (VOCs) detected in ground water at the West Well. The ground water withdrawn from the West Well is primarily used for process and non-contact cooling water. Water is distributed from a reservoir, and any excess overflows to a drainage ditch which enters Tributary 147. To date, the concentrations of VOCs discharged from the West Well have ranged from approximately 60 to 130 ppb.

The results of the field investigation were presented in an April 1986 report entitled, "Final Report - Hydrogeologic and Soils Investigation at the West Well and the West Parking Lot". As a result of the investigation, ERM has prepared this evaluation of alternatives for remediation of the VOCs detected in the vicinity of the West Well. This technical document presents the basis and method for remediation of the VOCs detected.

1.2 Potential Source Areas

Three potential source areas exist for the VOCs detected in the West Well. These potential source areas include:

- Former organic solvent storage tanks east of the West Well
- Waste oils which were spread across the West Parking Lot for dust control
- Prencos incinerator formerly located near the West Well

The former organic solvent storage tanks were located approximately 150 feet east of the West Well (see Figure 1-1). In this area, trichloroethene and 1,1,1-trichloroethane were stored in above ground tanks. In 1984, this area was reconstructed with substantial soil removal, construction of a loading dock and a new confined solvent storage facility with secondary containment. The surrounding area was paved.

Figure 1-1 General Site Map and Locations of Monitoring Wells

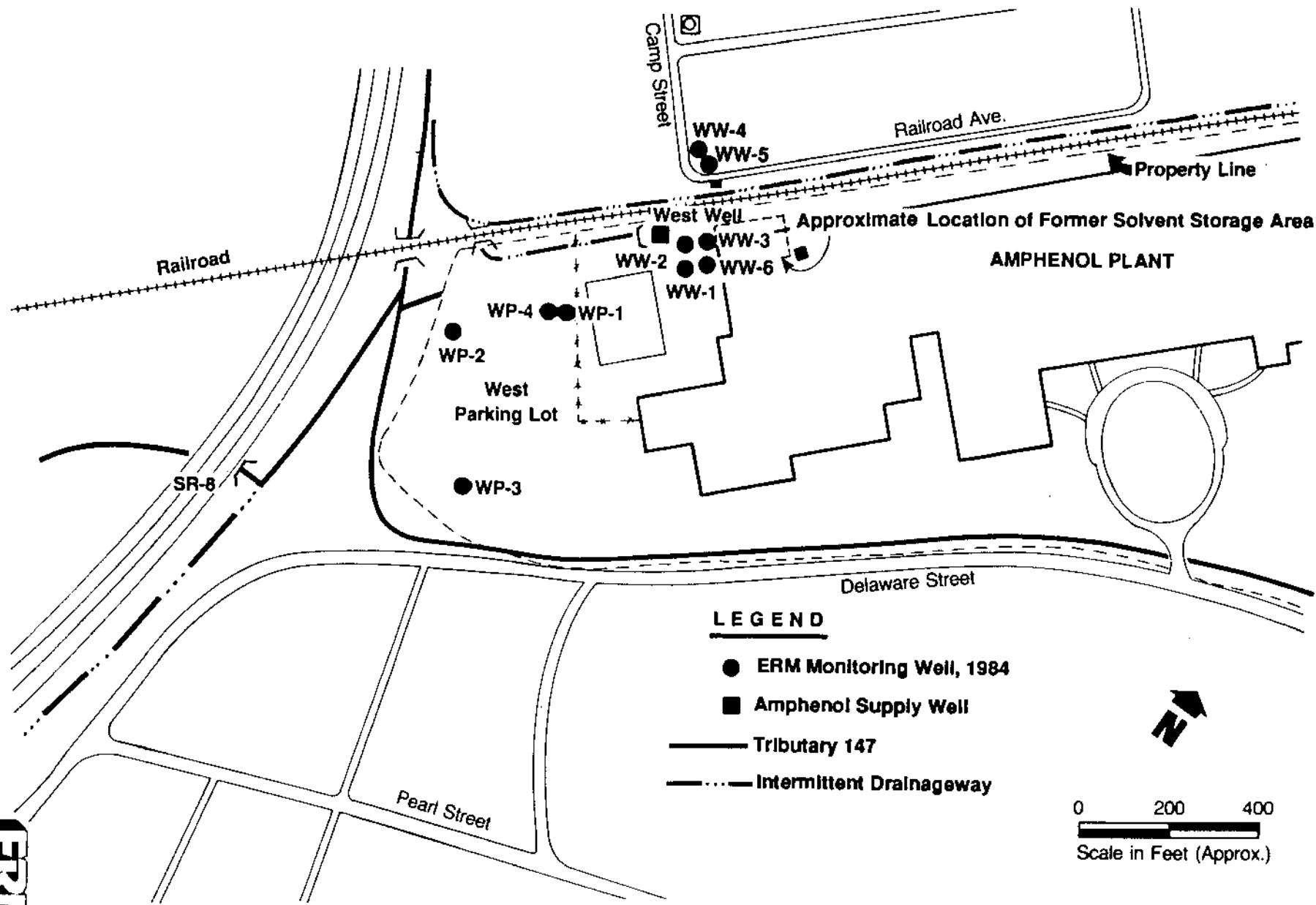

1-2



It was also reported that waste oils were used in the past for dust control in the West Parking Lot (Figure 1-1). Finally, a Preenco incinerator used to burn waste material was located near the West Well (Figure 1-1). This unit has undergone formal EPA closure and decontamination, and has been removed from the site.

1.3 Summary of Investigations

The hydrogeologic and soils investigation was completed in several phases during the years 1984, 1985, and 1986, and serves as the basis for definition of a remedial action program. Additional monitoring data have also been collected since the April 1986 final report, and are incorporated into the remedial evaluation.

The field investigation consisted of monitoring well and piezometer installations, ground water sampling and analysis, pump testing, surface soil/sediment sampling, and surface water sampling in the nearby drainageways. The well locations are shown in Figure 1-1. The findings and results of the investigation are summarized herein; for detailed discussion of existing conditions, the aforementioned reports should be reviewed.

1.3.1 Ground Water

1.3.1.1 Hydrogeology

Between April 1984 and February 1986, a total of ten wells/piezometers were installed to monitor the shallow and deep ground water systems within the vicinity of the West Well (Figure 1-1). ERM conducted pump tests of the West Well during July 1984 and February 1985. The objectives of the pump tests were to determine:

- the hydraulic relationship between the deep and shallow flow systems in the unconsolidated glacial drift;
- the transmissivity and hydraulic conductivity of the deep unconsolidated sediments; and
- the extent of the West Well cone of influence.

The pump tests indicated that the West Well draws its principal yield from the bedrock and glaciolacustrine fine sand sediments of the deep glacial flow component. The overlying shallow flow component, consisting of permeable sand and gravel, is partially hydraulically separated from the deep flow system by a sequence of lacustrine clayey silts.

1.3.1.2 Ground Water Quality

Analyses of ground water from the West Well have detected total VOCs at levels ranging from 57 ppb to 129 ppb. Ground water samples were collected during the field investigation from both the shallow and deep flow components to determine if detectable levels of VOCs or PCBs were present. The full period of record for ground water monitoring, from April 1984 through December 1986, is presented in Table 1-1. In the shallow flow component, VOCs were detected which ranged from less than 50 ppb to over 4,000 ppb in the ground water near the former solvent storage tanks. The VOC levels in excess of 4000 ppb were detected at WW-3 in July 1984, soon after soil removal and reconstruction of the solvent storage area had been completed. As a result of the reconstruction and soil removal, VOCs at WW-3 were reduced to 120 ppb when the next sampling event was completed in February 1985. Levels of VOCs in WW-3 have since been reduced to 32 ppb, as evidenced by the December 1986 sampling event.

In the deep flow zone, VOCs have been detected at up to 448 ppb near the former solvent storage tank area and at up to 980 ppb at the former Prencos incineration area. Concentrations of VOCs ranging from less than 1 ppb to 235 ppb were detected in the shallow ground water underneath the West Parking Lot. Concentrations ranged from none detected to 10 ppb in the deep zone in this area.

A trace level of PCBs (4 ppb) was detected in the sample from WW-2 in April 1984. PCBs were not detected at any other location during this sampling/analysis event.

1.3.1.3 Discussion of Results

The data show that pumping of the West Well has prevented any off-site migration of VOCs in the deep flow zone. As shown in Figure 1-2, an extensive cone of depression is maintained in the deep flow zone. In the shallow zone, migration has been limited to under 20 ppb by dilution, dispersion, and pumping of the West Well. The dynamics of vertical ground water flow at the West Well are complex. As previously noted, the shallow and deep aquifer zones are partially hydraulically separated by lacustrine sediments of low hydraulic conductivity. However, pumping of the West Well does affect flow in the shallow aquifer. This is evidenced by:

- the downward hydraulic gradients observed at piezometer pairs WP1/WP4, WW3/WW6, and WW4/WW5;

TABLE 1-1

SUMMARY OF ANALYTICAL RESULTS FOR GROUND WATER FROM WEST WELL AREA
 (Blank or ND = none detected; NA = not analyzed; Other unlisted constituents were not detected)

Well Number	Date Sampled	Lab*	Total Volatiles	Trans-1,2-Dichloro-ethene	Trichloro-ethene	Tetrachloro-ethene	1,1-Dichloro-ethane	1,1-Dichloro-ethene	Vinyl Chloride
West Well	7/25/84	F	57	4	53				
	5/22/86	L	129	17	110		2		
	11/25/86	L	113	22	89		2		
West Well Outfall	12/2/86	L	84	15	67		2		
WP-1	4/20/84	F	ND						
	7/25/84	F	127	83	39				5
	2/19/85	L	55	18	34		2	1	
	2/19/85	O	43	13	30				
WP-2	4/20/84	F	57	47	10				
	7/25/84	F	235	200	10				25
	2/20/85	L	21	13	7		1		
	2/20/85	O	ND						
	3/21/86	L	12	7	4		1		
WP-3	4/20/84	F	ND						
	7/25/84	F	1	1					
	2/20/85	L	3	3					
	2/20/85	O	ND						
WP-4	4/28/84	F	ND						
	7/25/84	F	7	6	1				
	2/19/85	L	7	5	2				
	2/19/85	O	ND						
	3/11/86	L	10	9	1				
	12/2/86	L	8	5	2				
WW-1	4/20/84	F	175	13	99	63			
	7/25/84	F	980	230	500	250			
	2/20/85	L	516	27	280	201	2		
	2/20/85	O	517	17	280	210			
	3/11/86	L	125	15	63	46	1		
	12/2/86	L	37	5	21	11			

All results are measured in ppb.

*Labs

F - Friends Laboratory

O - O'Brien and Gere

L - Lancaster Laboratories

**TABLE 1-1
(CONTINUED)**

Well Number	Date Sampled	Lab*	Total Volatiles	Trans-1,2-Dichloro-ethene	Trichloro-ethene	Tetrachloro-ethene	1,1-Dichloro-ethane	1,1-Dichloro-ethene	Vinyl Chloride
WW-2	4/20/84	F	123	65	35	13	10		
	7/25/84	F	205	56	120	26			3
	2/20/85	L	155	20	92	36	7		
	2/20/85	O	187	23	120	44			
	3/11/86	L	70	16	37	13	4		
	12/2/86	L	62	16	32	10	2		2
WW-3	4/20/84	F	768	300	310	14	5		130
	7/25/84	F	4550	3000	1500	15			35
	2/20/85	L	120	31	65	20	2		2
	3/11/86	L	96	47	33	11	2		3
	12/2/86	L	32	17	12	3			
WW-4	2/6/85	F	11	6	5				
	2/6/85	L	17	10	6		1		
	2/19/85	L	12	7	5				
	2/19/85	O	13		13				
	3/11/86	L	10	6	4				
	12/2/86	L	6	3	3				
WW-5	2/6/85	F	ND						
	2/6/85	L	ND						
	2/19/85	L	ND						
	2/19/85	O	ND						
	3/11/86	L	ND						
	12/2/86	L	ND						
WW-6	3/11/86	L	448	150	190		21		
	12/2/86	L	4	2	2				

TABLE 1-1
(CONTINUED)

Well Number	Date Sampled	1,1,1-Trichloro-ethane	Chloroform	Toluene	Chloro-benzene	1,2-Dichloro-ethane	Methylene Chloride	Freon	PCB
West Well	7/25/84								NA
	5/22/86								NA
	11/25/86								NA
Outfall	12/2/86								NA
WP-1	4/20/84								ND
	7/25/84								NA
	2/19/85								NA
	2/19/85								NA
WP-2	4/20/84								ND
	7/25/84								NA
	2/20/85								NA
	2/20/85								NA
	3/21/86								NA
WP-3	4/20/84								ND
	7/25/84								NA
	2/20/85								NA
	2/20/85								NA
WP-4	4/28/84								ND
	7/25/84								NA
	2/19/85								NA
	2/19/85								NA
	3/11/86								NA
	12/2/86							1	NA
WW-1	4/20/84							6	ND
	7/25/84								NA
	2/20/85		8						NA
	2/20/85								NA
	3/11/86								NA
	12/2/86								NA

1-7

Figure 1-2
Cone of Depression
Deep Flow Zone
February 22, 1985

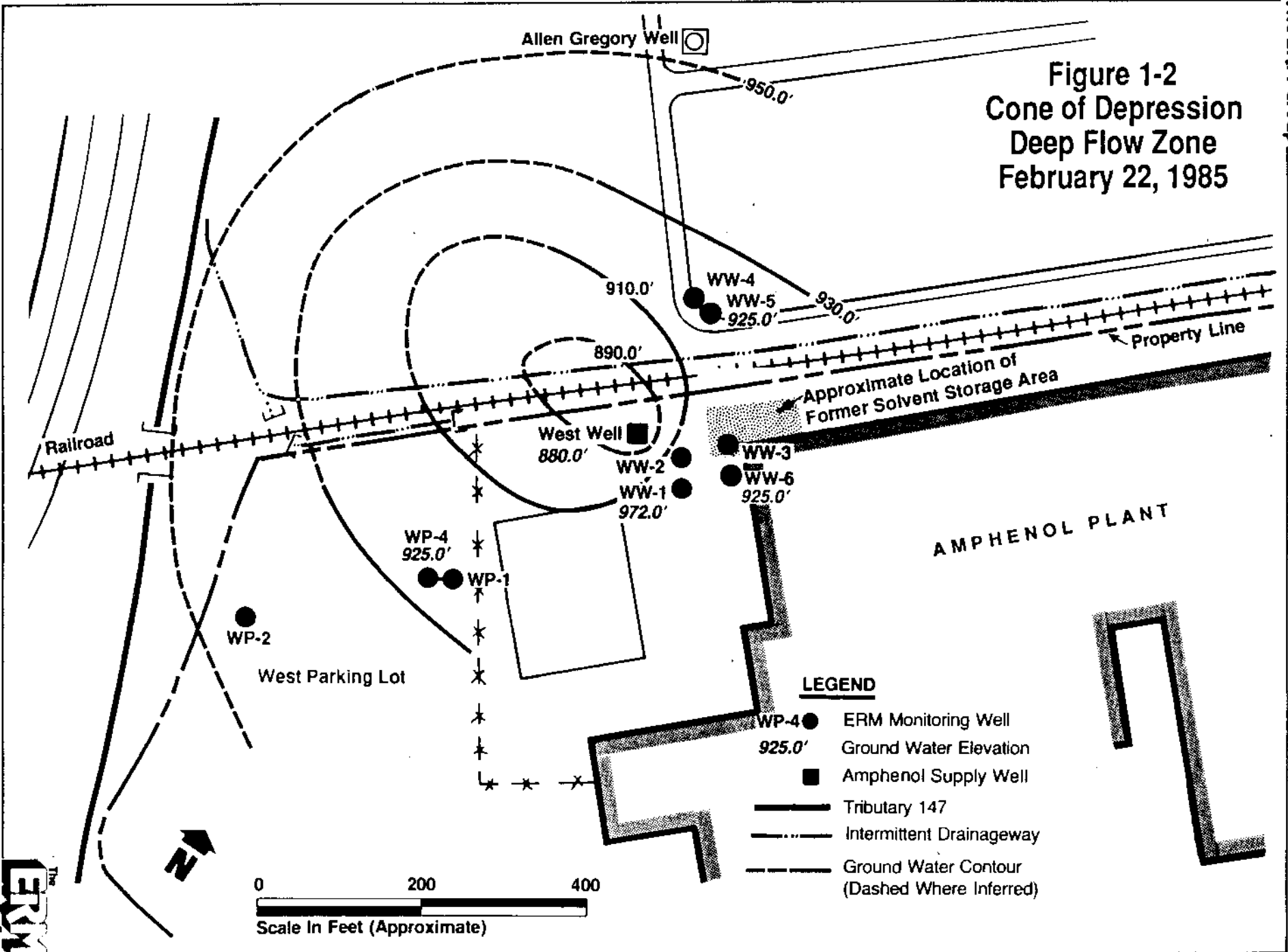

- the downward migration of VOCs at WW3/WW6 and at WP1/WP4;
- the effect, although somewhat limited, of the West Well pumping on the shallow water table configuration; and
- the very limited VOC migration off-site in the shallow flow zone, which indicates that flow in this zone is predominantly downward, under the influence of the West Well pumping.

Thus, the VOCs detected in the shallow aquifer at the former solvent storage tanks and beneath the West Parking Lot have migrated downward under the influence of the West Well pumping, and into the West Well. This has limited migration of VOCs off-site in the shallow aquifer.

The VOC distribution indicates that the former solvent storage tanks were the principal source of the VOCs in the West Well. The West Parking Lot area is not a major source area for the VOCs in the West Well. The much higher original concentrations at the solvent storage tank area have been the principal contribution to the West Well. Those original high concentrations have abated significantly in the shallow flow system since the source area was remediated during plant construction activities in 1984.

In the West Parking Lot area south and west of wells WP1/WP4, shallow VOC concentrations were highest at the west corner of the parking lot at well WP-2. At WP-2, the concentrations decreased from a high of 235 ppb in July 1984 to 12 ppb in December 1986. These results may reflect some seasonal difference in concentrations.

At WP-3, trace VOC concentrations of 3 ppb to none detectable indicate that the southwest section of the West Parking Lot is not a significant source area for VOCs in the ground water. No PCBs were detected in any of the West Parking Lot wells.

1.3.2 Soils/Sediments

In May 1984 ERM collected samples of shallow soils in an unpaved section of the West Parking Lot for analysis for PCBs and VOCs. In July 1984 ERM collected sediments from Tributary 147 for analysis. The locations of soil sampling at the West Parking Lot are shown in Figure 1-3, with results presented in Table 1-2. There were no detectable concentrations of VOCs. Two samples

Figure 1-3 Locations of Soil Samples In West Parking Lot

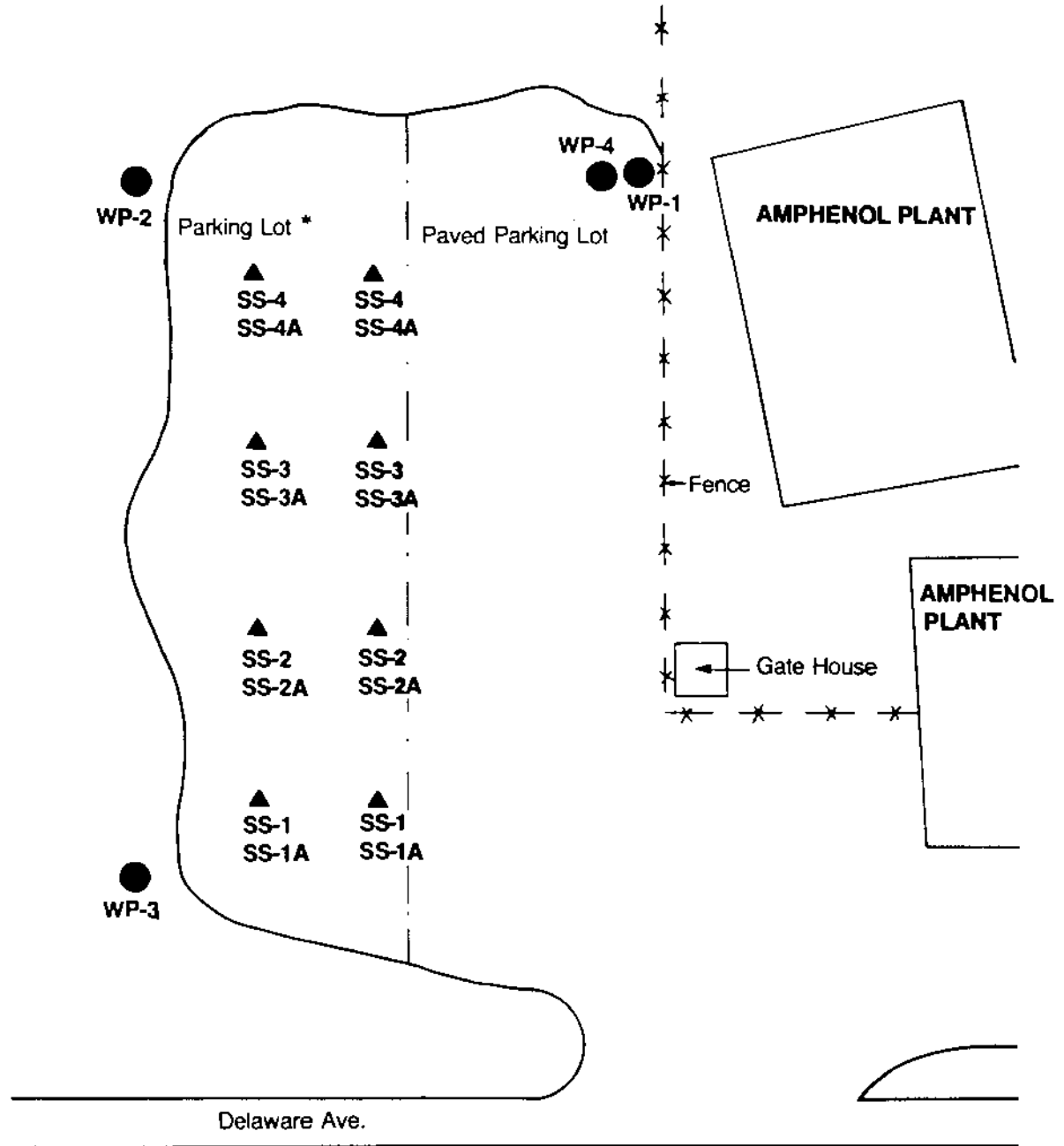

* Paved August 1984

LEGEND

- ERM Monitoring Well
- ▲ Soil Sample Location
- SS-1 Composite at 6"
- SS-1A Composite at 12"



TABLE 1-2

SUMMARY OF ANALYTICAL RESULTS FOR SOILS/SEDIMENT

West Parking Lot - May, 1984

Sample Locations	VOCs	PCBs
SS-1	ND	ND
SS-1A	ND	ND
SS-2	ND	ND
SS-2A	ND	85 ppm
SS-3	ND	ND
SS-3A	ND	6 ppm
SS-4	ND	ND
SS-4A	ND	ND

Tributary 147 - July, 1984

DS-2	NA	2 ppm
DS-2A	NA	2 ppm
DS-3	NA	ND
DS-3A	NA	ND
DS-4	NA	1 ppm
DS-4A	NA	1ppm
DS-5	NA	4 ppm
DS-5A	NA	ND
DS-6	NA	ND
DS-6A	NA	3 ppm

ND = None Detected
NA = Not Analyzed

showed detectable levels of PCBs (85 ppm at location 2A and 6 ppm at location 3A) at a depth of 6 to 12 inches in the West Parking Lot soils. The entire West Parking Lot has been paved since the investigation. This, coupled with the analytical results indicate that the West Parking Lot soils are not a continuing source area for VOC migration to the ground water or surface water. In regard to PCBs, their immobility in the soils and their isolation from infiltrating precipitation by the paving of the West Parking Lot preclude any migration to the ground water. As previously noted, no PCBs were detected in any of the West Parking Lot monitoring wells.

PCBs were detected in bottom sediments from Tributary 147 at locations DS2, DS4, DS5, and DS6, ranging up to 4 ppm (Figure 1-4). Little variation in PCB concentrations were observed with depth in these sediments.

1.3.3 Surface Water

To assess Tributary 147 waters, surface water samples were collected for analysis in July 1984, and again in December, 1986 to obtain up-to-date information on VOCs and the potential for PCB concentrations in site drainageway waters. The surface water sampling locations are shown in Figure 1-5. The July 1984 sampling event was part of a program to evaluate the area surface drainageways on a more regional basis, with potential effects of other, upgradient source areas included. For clarity, the stream sampling locations from the two sampling events have been combined, and designated locations SW-1 through SW-9, as shown in Figure 1-5. These locations are described in Table 1-3. The analysis results are shown in Table 1-4.

The results of the surface water VOC analyses at SW-1 indicate that no VOCs enter the site from upstream in the main branch of Tributary 147 at SW-1, or in the stormwater drainageway samples at SW-2. However, the July 1984 analysis indicated that 366 ppb of VOCs were present in the unnamed tributary at SW-3. This area is currently being studied as part of the Route 8 Landfill investigation. Downgradient of SW-3, at SW-4, residual VOCs in the unnamed tributary were detected at 14 ppb in December 1986. Since the main branch of Tributary 147 lies between this location and the West Parking Lot, it is likely that the VOCs at SW-4 represent residual from the upgradient source area, rather than discharge from ground water beneath the West Parking Lot.

Adjacent to the West Parking Lot, at SW-5, 7 ppb and 2 ppb of TCE were detected in July, 1984 and December 1986, respectively. This represents the contribution from discharging ground water from the West Parking Lot area. Downstream, at SW-6, the total

Figure 1-4 Locations of Tributary 147 Sediment Samples

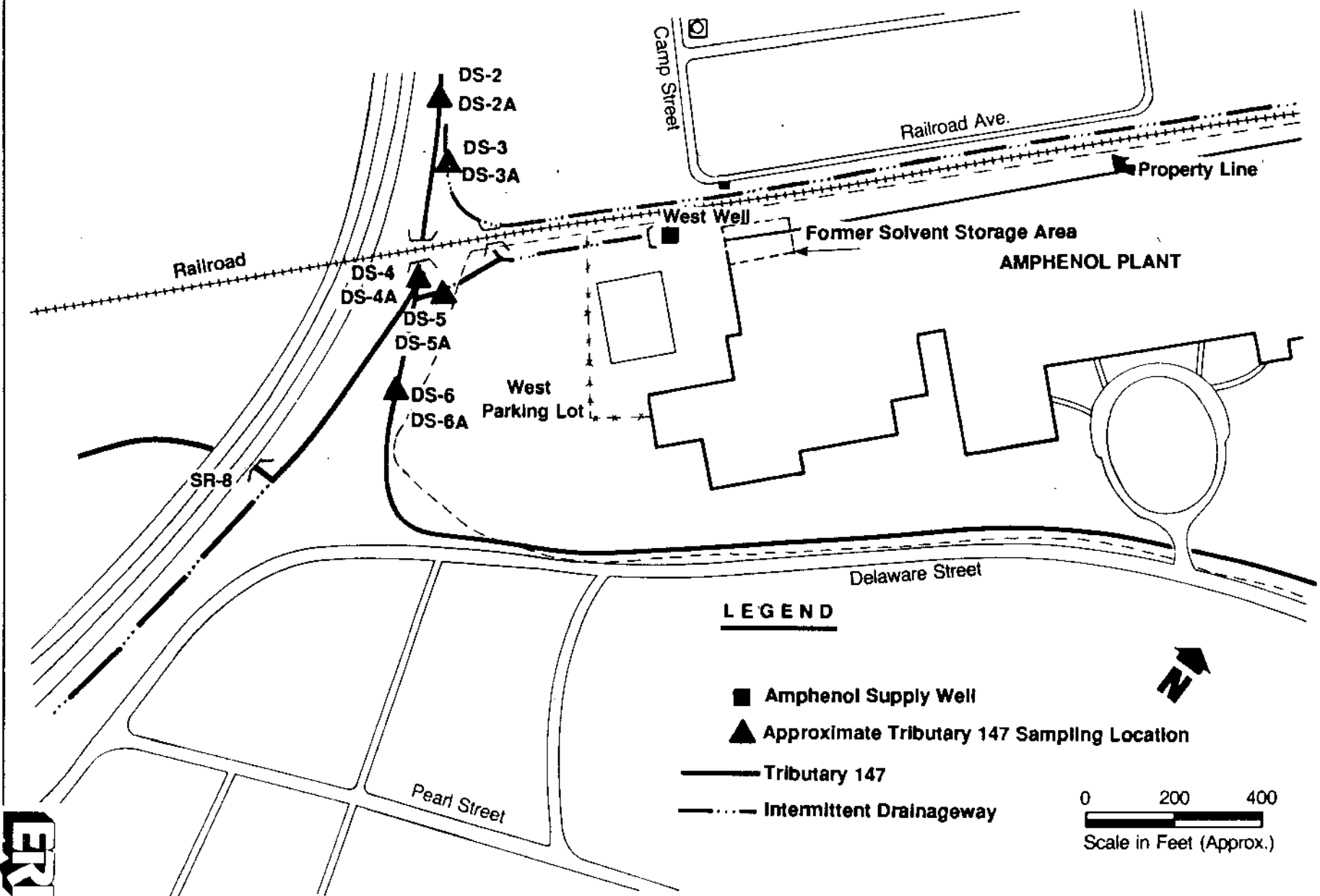

LEGEND

- Amphenol Supply Well
- ▲ Approximate Tributary 147 Sampling Location
- Tributary 147
- - - Intermittent Drainageway



 0 200 400
 Scale in Feet (Approx.)



Table 1-3

SURFACE WATER SAMPLING LOCATIONS

- SW-1 Upgradient, near Amphenol South Gate. Sampled December 1986.
- SW-2 Upgradient in intermittent storm water drainageway. Sampled July 1984.
- SW-3 Upgradient in unnamed tributary to Tributary 147. Sampled July 1984.
- SW-4 Unnamed tributary to Tributary 147, before confluence with main branch of Tributary 147, adjacent to West Parking Lot. Sampled December 1986.
- SW-5 Main branch of Tributary 147, adjacent to West Parking Lot. Sampled July 1984 and December 1986.
- SW-6 Immediately below confluence of unnamed tributary and main branch of Tributary 147, downstream of West Parking Lot. Sampled July 1984 and December 1986.
- SW-7 West Well outfall to drainage ditch. Sampled December 1986.
- SW-8 Drainage ditch north of railroad tracks, downstream of West Well outfall. Sampled July 1984 and December 1986.
- SW-9 Immediately downstream of confluence of West Well outfall drainage ditch and Tributary 147. Sampled July 1984 and December 1986.

TABLE 1 - 4

SUMMARY OF ANALYTICAL RESULTS FOR SURFACE WATER OF TRIBUTARY 147
 (Blank or ND = none detected; NA = not analyzed; Other volatile constituents were not detected)

Well Number	Date Sampled	Lab*	Total Volatiles	Trans-1,2-Dichloro-ethane	Trichloro-ethane	Tetrachloro-ethane	1,1-Dichloro-ethane	1,1,1-Trichloro-ethane	1,1,1,2-Trichloro-ethane	Vinyl Chloride	PCB
SW - 1	12/2/86	L	ND								NA ND(<0.08 ppb)
SW - 2	7/18/84	L	ND								NA
SW - 3	7/19/84	L	368	280	15		23	22	.18	8	NA
SW - 4	12/2/86	L	14	8	1		2	3			ND(<0.2 ppb)
SW - 5	7/20/84	F	7		7						NA
SW - 5	12/2/86	L	2		2						ND(<0.3 ppb)
SW - 6	7/20/84	F	35	21	14						NA
SW - 6	12/2/86	L	4	2	2						ND(<0.3 ppb)
SW - 7	12/2/86	L	84	15	87		2				ND(<0.08 ppb)
SW - 8	7/20/84	F	8	2	6						NA
SW - 8	12/2/86	L	34	8	28						ND(<0.08 ppb)
SW - 9	7/20/84	F	15	6	9						NA
SW - 9	12/2/86	L	13	3	10						ND(<0.3 ppb)

All results are measured in ppb.

*Lab
 F - Friend Laboratory
 O - O'Brien and Gere
 L - Lancaster Laboratories

VOCs detected were 35 ppb and 4 ppb during those same sampling events. The additional VOCs were contributed to the main branch from the upstream unnamed tributary discharge.

The sample from the West Well outfall (SW-7) contained 84 ppb in December of 1986. Downstream in the drainage ditch, at SW-8, VOC concentrations were 8 ppb and 34 ppb in July 1984 and December 1986. These are residuals from the West Well outfall. At SW-9, below the confluence of the drainage ditch and Tributary 147, the concentrations were 15 ppb and 13 ppb in July 1984 and December 1986. Thus, it is possible that the outfall raised total VOCs in Tributary 147 by 9 ppb in December 1986. However, concentrations actually decreased by 20 ppb in Tributary 147 after confluence with the West Well outfall during the July 1984 sampling event.

No PCBs were detected in the surface water samples from December 1986 at the detection limits shown in Table 1-4.

Several observations can be made from these results:

- Discharge of ground water from the West Parking Lot area contributes less than 10 ppb of VOCs to Tributary 147.
- The principal VOC contribution to Tributary 147 comes from upgradient in the unnamed tributary.
- The West Well outfall contributes slightly to the VOCs in Tributary 147. The degree to which can be detected depends upon the discharge volume at the outfall, which varies depending on Amphenol plant water demand. The Tributary 147 flow volume conditions may also contribute to the degree of detection.
- PCBs have not been detected in the surface waters.

1.4 Conclusions of Investigations

After evaluation of all water quality, soils, piezometric levels, and pump test data, the hydrogeologic and soils investigations have resulted in several conclusions relating to the assessment of VOCs detected at the West Well.

- The principal source area for VOCs at the West Well is the former solvent storage tank area; the north and west section of the West Parking Lot is a secondary source area.
- The West Parking Lot soils do not serve as a continuing source of VOCs to the ground water; the former storage

tank area was remediated during plant construction activities.

- Pumping at the West Well has created a vertical component of ground water flow which has caused VOCs to migrate into the deep flow zone, and has thus limited off-site migration in the shallow flow zone to less than 20 ppb of VOCs.
- The West Well pumping has created a cone-of-depression which prevents any off-site VOC migration in the deep flow zone.
- Some low level VOCs discharge from beneath the West Parking Lot into Tributary 147.
- PCBs are present in Tributary 147 sediments at concentrations ranging from 1 ppm to 4 ppm. The general absence of PCBs and the placement of pavement over the West Parking Lot have eliminated any potential for future migration to Tributary 147.
- VOCs enter Tributary 147 from an upstream source via the westerly unnamed tributary, from ground water discharge from the West Parking Lot, and from the West Well outfall.
- Because of dilution and aeration, total VOCs in Tributary 147 are usually less than 20 ppb.
- PCBs were not detected in Tributary 147 waters.

1.5 Objectives of Remediation

Based on the results of the field investigation, two primary objectives have been identified for remedial action in the West Well area:

1. the mitigation of any impact from exposure to ground water, surface water, soil and/or sediments in the affected area; and
2. addressing applicable standards and guidelines established by the NYSDEC pertaining to site-related ground water, surface water and soil.

SECTION 2

SITE IMPACT ASSESSMENT/REMEDIAL REQUIREMENTS

2.1 Site Impact Assessment

To determine the need for remedial action at the West Well site, two factors were considered:

- potential for impacts from public exposure to compounds of concern; and
- potential violation of regulatory standards, or in the absence of standards, comparison to guideline values, where available.

2.1.1 Potential for Public Exposure Impacts

Public exposure to chemical compounds in the environment is difficult to assess, as little is known about the potential effects of low-level chemical exposures at this time. Currently, the USEPA has developed methods for calculating approximate levels of non-carcinogenic and carcinogenic risk for the compounds of concern at the West Well/West Parking Lot site. Although these methods are subject to question because of the lack of actual epidemiological data from human exposures, they can be applied at waste disposal sites to determine relative need for remediation. Currently, under the Superfund program, the EPA considers a carcinogenic risk of one in ten thousand (1×10^{-4}) to one in ten million (1×10^{-7}) to be potentially acceptable at any given site. A general guideline for ground water remediation is currently a risk level of one in one million (1×10^{-6}).

Due to the limited scope and concentrations of compounds associated with the West Well/West Parking Lot area, no formal risk assessment has been performed. However, risk assessment for some very similar exposures has been conducted nearby, for the Amphenol Hill Site. The similarity of compounds present, media of potential exposure, and exposure point concentrations allows for order of magnitude risk levels to be approximated without full risk assessment at the West Well. For USEPA methodologies employed, and detailed calculations, the reader is referred to the April, 1987 report: "Remedial Investigations and Feasibility Studies at the Hill Site: Volume III-Site Risk Assessment".

2.1.2 Comparison to Standards/Guidelines

The second criterion by which the West Well/West Parking Lot area was assessed was a comparison to regulatory standards, or guidelines where they existed. Table 2-1 shows applicable regulatory standards and guidelines for the compounds associated with the site. It should be noted that only the standards are enforceable criteria. However, in the absence of standards for most site-related compounds in the ground water, surface water, and soil media, available guidelines are also listed in Table 2-1 to allow for a better overview of site-related conditions.

The factors above are considered for each potential pathway of compound migration and/or exposure. Based on the hydrogeologic and soils investigations, there are three pathways for potential exposure to the compounds identified. These are ground water, surface water, and soils/sediments. Each of these is discussed in the following sections.

2.2 Ground Water

The results of the hydrogeologic investigation identified two principal ground water flow systems: a shallow system in the unconsolidated glacial deposits, and a deeper glacial system from which the West Well draws water. The results of ground water quality monitoring to date were shown in Table 1-1 with monitoring well/piezometer locations indicated in Figure 1-1. As shown, total VOCs ranging from below the laboratory detection limit to approximately 200 ppb are present in the shallow flow system, and up to approximately 500 ppb in the deep system. The potential ground water pathway for public exposure to VOCs would be through potable water supply wells using either the shallow or deep ground water flow systems.

2.2.1 Shallow Flow System

Results of the 1985 and 1986 ground water analyses from the shallow flow system are shown in Table 2-2. The 1984 results are not considered here, due to the declining VOC trends in both the West Well and West Parking Lot areas. The data indicate that maximum concentrations of VOCs of 32 ppb to 120 ppb are present in the ground water at Well WW-3, in the former solvent storage area east of the West Well. Concentrations of up to 235 ppb were originally present in the shallow ground water underlying the West Parking Lot at Well WP-2, but have since reduced to 12 ppb to 21 ppb. Up to 187 ppb were detected in 1985 at the former Prencos incinerator area (Well WW-2), with a maximum of 70 ppb in 1986. Off-site and downgradient to the north, Well WW-4 contained a maximum of 17 ppb total VOCs in 1985 and 10 ppb in 1986.

TABLE 2-1

REGULATORY CRITERIA FOR SITE EVALUATION
(NS = No Standard/Guideline)

	<u>Ground Water Standards (S) or Guidelines (G) ug/l)</u>	<u>NYSDEC Surface Water Standard (ug/l)</u>	<u>Guidelines for Protection of Aquatic Life (ug/l)*</u>	<u>NYSDEC Soil Guideline (mg/kg)</u>
Trichloroethene	10 (S)	NS	21,900	NS
Trans-1,2 Dichloroethene	50 (G)	NS	20,000	NS
Tetrachloroethene	0.07 (G)	NS	840	NS
1,1 Dichloroethane	50 (G)	NS	NS	NS
1,1 Dichloroethene	0.07 (G)	NS	NS (11,600 acute)	NS
Vinyl Chloride	5 (S)	NS	NS	NS
1,1,1, Trichloroethane	50 (G)	NS	NS (52,800 acute)	NS
Chloroform	100 (S)	NS	1,240	NS
Toluene	50 (G)	NS	NS (17,500 acute)	NS
1,2 Dichloroethane	0.8 (G)	NS	20,000	NS
Chlorobenzene	20 (G)	50	50	NS
PCB	0.1 (S)	0.001	0.014	10

* Lowest observed effects level (LOEL) for Chronic exposure. Source: Quality Criteria for Air and Water, USEPA, 1986.

TABLE 2-2
SUMMARY OF 1985 and 1986 ANALYTICAL RESULTS FOR SHALLOW GROUND WATER
 (Blank or ND = none detected; NA = not applicable; Other volatile constituents were not detected)

Well Number	Date Sampled	Lab*	Total Volatiles	Trans-1,2-Dichloro-ethene	Trichloro-ethene	Tetrachloro-ethene	1,1-Dichloro-ethane	1,1-Dichloro-ethene	Vinyl Chloride
WP-1	2/19/85	L	52	18	34		2	1	
	2/19/85	O	43	13	30				
WP-2	2/20/85	L	21	13	7		1		
	2/20/85	O	ND						
	3/21/86	L	12	7	4		1		
WP-3	2/20/85	L	3	3					
	2/20/85	O	ND						
WW-2	2/20/85	L	155	20	92	36	7		
	2/20/85	O	187	23	120	44			
	3/11/86	L	70	16	37	13	4		
	12/2/86	L	62	16	32	10	2		2
WW-3	2/20/85	L	120	31	65	20	2		2
	3/11/86	L	96	47	33	11	2		3
	12/2/86	L	32	17	12	3			
WW-4	2/6/85	F	11	6	5				
	2/6/85	L	17	10	6		1		
	2/19/85	L	12	7	5				
	2/19/85	O	13		13				
	3/11/86	L	10	6	4				
	12/2/86	L	6	3	3				

NYSDEC Standard Guidance Value	NA 50 ppb	10 ppb NA	NA 0.7 ppb	NA 50 ppb	NA 0.07 ppb	NA 5.0 ppb
--------------------------------	--------------	--------------	---------------	--------------	----------------	---------------

All results are measured in ppb

*Labs

- F - Friends Laboratory
- O - O'Brien and Gere
- L - Lancaster Laboratories

The results of a 1985 New York Department of Health analysis of water from an unused shallow well at the Allen Gregory residence, north of the Amphenol plant, indicated the presence of 2 ppb total VOCs. This included two compounds which were also detected in the vicinity of the West Well. The extent of shallow VOC migration has therefore been defined by the analyses from the Allen Gregory well and the off-site monitoring Well WW-4.

2.2.1.1 Potential for Public Exposure

There presently are no wells in the vicinity of the Amphenol Corporation plant site which utilize shallow ground water as a source of potable water. The area is fully served by the Village of Sidney public water supply. The absence of potable water supply wells within the shallow flow zone eliminates possible health risks to the public by this pathway.

2.2.1.2 Ground Water Standards and Guidelines

As shown on Table 2-1, NSYDEC Ground Water Standards exist for trichloroethene, vinyl chloride, chloroform and PCBs. Guideline values are available for the other site-related compounds.

The recent analyses of ground water from well WW-4 indicate that NYSDEC ground water quality standards and guidelines are not exceeded off the Amphenol property. Total VOCs have ranged from 6ppb to 17 ppb at WW-4, with the volatiles consisting primarily of trans-1,2-dichloroethene at levels ranging from less than 1 ppb to 10 ppb, and trichloroethene ranging from 3 ppb to 13 ppb. The 13 ppb of trichloroethene exceeds the NYSDEC standard of 10 ppb, but a split analysis of the same sample indicated a trichloroethene level of only 5 ppb. Previous and subsequent analyses have confirmed trichloroethene levels below the 10 ppb standard.

Analyses of ground water from on-site shallow monitoring wells during 1985 and 1986 indicated total VOCs ranging from less than 1 ppb to 187 ppb. The trichloroethene standard of 10 ppb was exceeded at wells WP-1, WW-2, and WW-3, with concentrations ranging from less than 1 ppb to 120 ppb. No other NYSDEC standard has been exceeded. However, guidance values for 1,1-dichloroethene, 1,2-dichloroethene and 1,1,1-trichloroethane have been exceeded. Also, the detection of 4 ppb of PCB in July 1984 should be noted as this exceeded the NYSDEC standard of 0.1 ppb.

2.2.1.3 Remedial Action Requirements

The shallow ground water flow zone is not used and no standards are exceeded off the Amphenol property. In addition, the VOC concentrations in this zone have decreased substantially from

1984 to the present. Remedial actions to date, including removal of the main source area and pumping at the West Well, have been shown to have provided remedial action for ultimately meeting the NYSDEC ground water standards in the shallow aquifer. In addition, the discharge of ground water from beneath the West Parking Lot to Tributary 147 does not adversely affect the stream (this is discussed further in Section 2.3, Surface Water). Thus, there is no need for additional direct remediation of the shallow ground water flow zone. Continued pumping of the West Well is recommended to ensure that the NYSDEC standards will not be exceeded off-site, and also to reduce the on-site concentrations of trichloroethene and PCB in excess of those standards, until they are no longer exceeded.

2.2.2 Deep Flow System

Since the effects of source area remediation in 1984 may not be as rapidly reflected in the deep system as in the shallow, the full period of record is considered for the deep system. This is summarized in Table 2-3. The analyses of ground water from the deep flow zone have indicated the presence of VOCs ranging from 37 ppb to 980 ppb at Well WW-1, 4 ppb to 448 ppb at WW-6, less than 10 ppb at WP-4 and none detectable off-site at WW-5. The results at WW-1, WP-4 and WW-6 indicate that there has been vertical migration of VOCs through the glacial overburden in the immediate vicinity of the former location of the solvent storage tanks, and to a lesser extent at the northeast end of the West Parking Lot. Data from WW-5 and piezometric surface mapping of the deep flow system indicate that the VOC plume is restricted to the Amphenol property by the pumping of the West Well. The continued withdrawal of ground water from the West Well will prevent any off-site migration of VOCs in the deep flow system.

2.2.2.1 Potential for Public Exposure

At no location within the extent of the VOC plume is the deep ground water used for a potable water supply. Since this ground water is not used as a source of potable water, and VOCs are contained on the Amphenol property, no public health risk exists.

2.2.2.2 Ground Water Standards and Guidelines

The analysis results from the deep flow system and the associated NYSDEC standards and guideline values are shown in Table 2-3. As exhibited by data from Well WW-5, off-site VOC migration has not occurred in the deep flow system. Thus, ground water standards and guidelines as set forth by the NYSDEC are met beyond the Amphenol property.

TABLE 2-3
SUMMARY OF ANALYTICAL RESULTS FOR DEEP GROUND WATER
 (Blank = none detected; Other volatile constituents were not detected)

Well Number	Date Sampled	Lab*	Total Volatiles	Trans-1,2-Dichloro-ethene	Trichloro-ethene	Tetrachloro-ethene	1,1-Dichloro-ethene
West Well	7/25/84	F	57	4	53		
	5/22/86	L	129	17	110		2
	11/25/86	L	113	22	89		2
WP-4	4/28/84	F	ND				
	7/25/84	F	7	6	1		
	2/19/85	L	7	5	2		
	2/19/85	O	ND				
	3/11/86	L	10	9	1		
	12/2/86	L	8	5	2		
WW-1	4/20/84	F	175	13	99	63	
	7/25/84	F	980	230	500	250	
	2/20/85	L	516	27	280	201	2
	2/20/85	O	517	17	290	210	
	3/11/86	L	125	15	63	46	1
	12/2/86	L	37	5	21	11	
WW-5	2/6/85	F	ND				
	2/6/85	L	ND				
	2/19/85	L	ND				
	2/19/85	O	ND				
	3/11/86	L	ND				
	12/2/86	L	ND				
WW-6	3/11/86	L	448	150	190		21
	12/2/86	L	4	2	2		
NYSDEC Standard Guidance Value				NA 50 ppb	10 ppb NA	NA 0.7	NA 50

All results are measured in ppb
 NA = none applicable
 ND = not detected

*Labs

F - Friends Laboratory
 O - O'Brien and Gere
 L - Lancaster Laboratories

TABLE 2-3
(CONTINUED)

Well Number	Date Sampled	1,1,1-Trichloro-ethane	Chloroform	Toluene	Chloro-benzene	1,2-Dichloro-ethane	Methylene Chloride	Freon	PCB
West Well	7/25/84 5/22/86 11/25/86								
WP-4	4/28/84 7/25/84 2/19/85 2/19/85 3/11/86 12/2/86						1		ND NA NA NA NA NA
WW-1	4/20/84 7/25/84 2/20/85 2/20/85 3/11/86 12/2/86		6					6	ND NA NA NA NA NA
WW-5	2/6/85 2/6/85 2/19/85 2/19/85 3/11/86 12/2/86								
WW-6	3/11/86 12/2/86	78		5	2	2			
NYSDEC Standard Guidance Value		NA 50 ppb	NA 100 ppb	NA 50 ppb	NA 20 ppb	NA 0.8 ppb		NA 50 ppb	NA NA

2-8

The ground water analyses for the deep on-site monitoring wells indicate that the NYSDEC standard for trichloroethene is exceeded at wells WW-1 and WW-6, with concentrations detected ranging from 2 ppb to 500 ppb. In addition, the guideline values for 1,1,1-trichloroethane, tetrachloroethene and 1,1,1-trichloroethene have been exceeded on-site occasionally.

2.2.2.3 Remedial Action Requirements

Based on ERM's analysis of hydrogeologic conditions and recent monitoring of ground water quality at the Amphenol plant, continued ground water recovery is necessary to prevent VOC migration off-site in the deep flow system. The West Well, which pumps continuously at approximately 300 gpm, has been shown to effectively contain and retrieve the VOCs in the deep flow system. Continued pumping of the West Well is therefore recommended to prevent off-site migration of VOCs in the deep system, and to reduce the VOCs on site to below the NYSDEC standard of 10 ppb for trichloroethene.

2.3 Soils/Sediments

The potential impacts and need for remedial action in the West Parking Lot soils and Tributary 147 sediments are discussed as below.

2.3.1 West Parking Lot

Soil sampling was conducted at the West Parking Lot to determine if PCBs or VOCs are present as a result of past dust control activities. As Table 1-2 indicates, there were no detectable VOCs in the soils, nor were there any detectable concentrations of PCBs within the upper several inches of soil beneath the parking lot. However, analysis of samples 2A and 3A, taken at a depth of approximately 6 to 12 inches, indicated localized PCB concentrations of 85 ppm and 6 ppm, respectively.

2.3.1.1 Potential for Public Exposure

Since the residual PCB was present at only two spot locations, both below the surface soil, and since the West Parking Lot has been completely asphalt paved, there exists no potential for public contact with the PCBs or for migration of the PCBs by erosion. Since no VOCs were detected in the soil, no potential VOC migration or public health impact exists.

2.3.1.2 State Standards and Guidelines

Only Sample 2A exceeded the NYSDEC guideline of 10 ppm for PCBs in soils. As ground water analyses from the West Parking Lot

area indicated no detectable PCBs, it is evident that the limited residual PCBs are fully attenuated within the soil and are not migrating downward into the ground water.

2.3.1.3 Remedial Action Requirements

Based on the above, no remedial action is necessary for the West Parking Lot soils.

2.3.2 Tributary 147 Sediments

Sediment sampling was conducted at various locations within Tributary 147. PCBs were detected in sediments from sample locations DS-2, DS-4, DS-5, and DS-6, with a maximum concentration of 4 ppm. There was little variation noted in PCB concentration with depth of the sample at any locations. No VOCs were detected in the sediment samples.

2.3.2.1 Potential for Public Exposure

Human exposure to VOCs or PCBs in the sediment of Tributary 147 is very unlikely. Should direct contact occur, it would be over a very short time period. Such exposure would be rare since the Tributary is actually a reconstructed drainageway for Route 8, and is not used for recreational purposes. The concentrations in the tributary sediments are comparable to those reported at the Amphenol Hill Site in surface soils. A risk assessment at that site, using EPA methods, indicated a carcinogenic risk level of approximately 3×10^{-6} associated with soils containing 4 ppm of PCBs ("Remedial Investigations and Feasibility Studies at the Hill Site; Volume III, Risk Assessment"). This is well within the EPA-defined range of potentially acceptable risk, which is 1×10^{-4} to 1×10^{-7} .

2.3.2.2 Standards and Guidelines

There is no NYSDEC standard for maximum concentrations of PCBs in soils with respect to human exposure. The NYSDEC has established a PCB guideline for soil cleanup of 10 ppm. The maximum detected level of 4 ppm PCBs is below that NYSDEC guideline.

2.3.2.3 Remedial Action Requirements

Since pavement has now been placed across the parking lot area, there is no potential for migration of the PCB to the site drainageways. Additionally, since Tributary 147 is rarely utilized by the public, the calculated risk level is very low, and the sediment PCB levels are below the NYSDEC guideline, no remediation is required for that pathway.

Figure 1-5 Tributary 147 Surface Water Samples

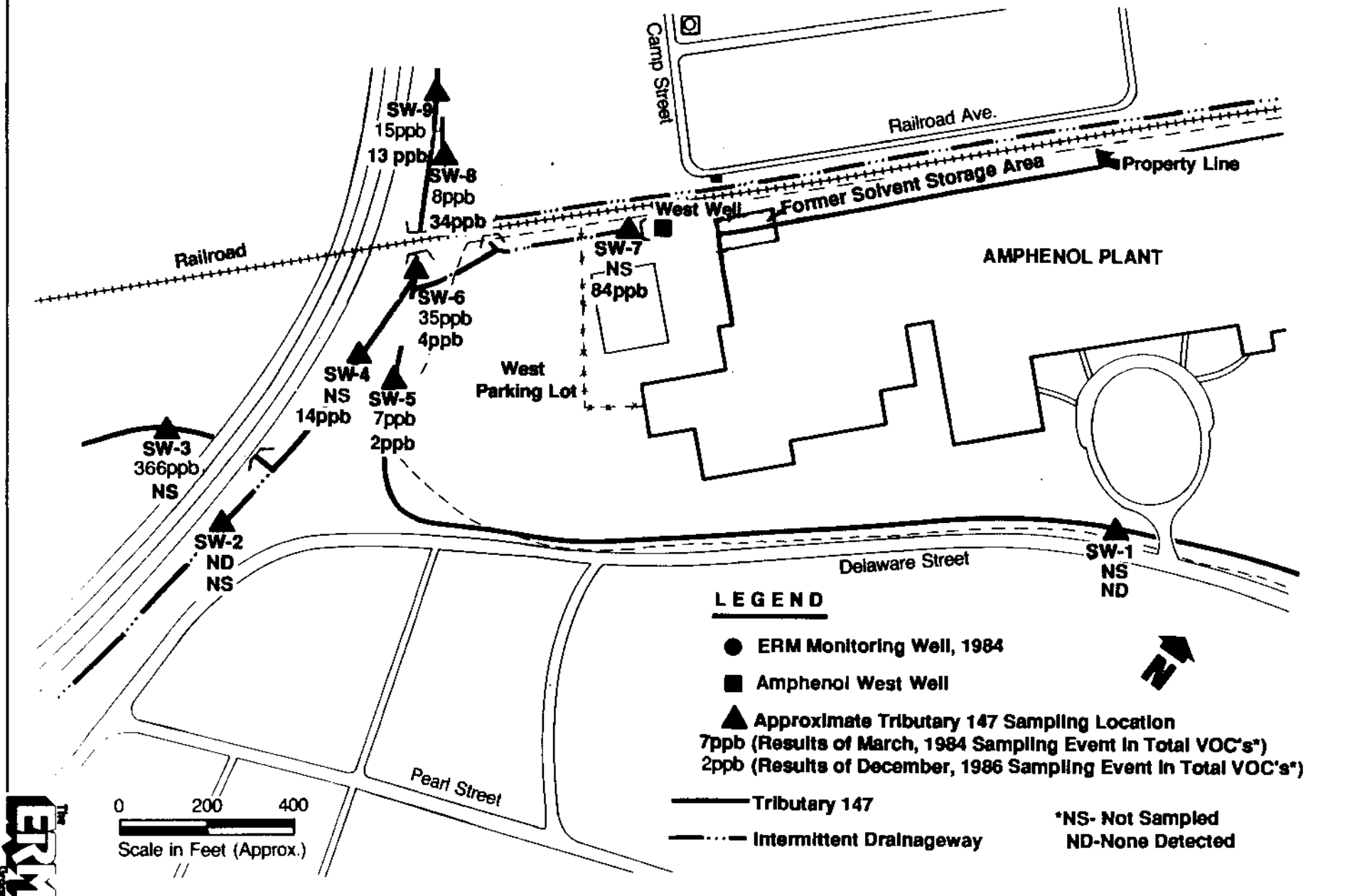

2.3.3 Soils at Former Solvent Storage Tank Area

The third area of potential soil exposure is at the former solvent storage tank area. As previously described, soils were removed from this area during plant construction activities in 1984. Any residual is now covered by plant building facilities, with fringe areas covered by paving.

2.3.3.1 Potential for Public Exposure

No direct public exposure is possible to any VOC containing soils in this area.

2.3.3.2 Standards and Guidelines

No standards or guidelines exist for VOCs in soils.

2.3.3.3 Remedial Action Requirements

The effectiveness of the plant reconstruction activities in reducing VOC migration to ground water is evident in the data collected at Well WW-3. Thus, the clear trend of reduction of VOCs in the ground water indicate that no further remedial action is required at this location.

2.4 Surface Water

Surface water sampling and analysis was conducted in Tributary 147 on two occasions; in July 1984 to determine VOC concentrations in the regional surface waters, and in December 1986 to determine VOC and PCB levels with respect to the West Parking Lot area, and to evaluate the effect of West Well overflow to the tributary. The surface water sampling locations were shown in Figure 1-5, and the analytical results were summarized in Table 1-4.

As discussed in Section 1, VOCs are present in Tributary 147 adjacent to the West Parking Lot and in the overflow from the West Well. The minimum concentration detected was 2 ppb, adjacent to the West Parking Lot, and the maximum was 35 ppb, where VOCs in the upstream unnamed tributary enters Tributary 147. The West Well outfall, in combination with all other sources, resulted in concentrations of 13 and 15 ppb detected in Tributary 147. Again, no PCBs were detected in the Tributary 147 samples taken in December, 1986.

2.4.1 Potential for Public Exposure

Potential public exposure is limited to dermal or inhalation contact with volatile compounds present in Tributary 147. Again,

public use of the stream is rare. As discussed in Section 2.2.2.1, a relative assessment of potential risk can be made by comparison with the nearby Hill Site, which underwent formal risk assessment for a similar suite of VOCs. In that study, surface water VOC concentrations exceeding 100 ppb resulted in a calculated carcinogenic risk level of approximately 9.5×10^{-7} . The risk at Tributary 147 would be even lower, as the maximum VOC concentration detected in Tributary 147 is 35 ppb. Thus, the public health risk is below any potentially unacceptable EPA risk level.

2.4.2 Standards and Guidelines

NYSDEC surface water standards vary depending upon surface water usage and classification of the water body. For the compounds in question, standards exist only for drinking water sources. Tributary 147 waters are not a drinking water source, and it is considered by the NYSDEC to be a Class "D" stream. Since Tributary 147 is a Class "D" stream, no NYSDEC standard or guideline values exist for the VOCs detected in the West Well studies. However, a PCB standard of 0.001 ppb does exist. Due to interference of sample turbidity, detection limits as low as this standard were not achievable in the laboratory.

For purposes of comparison, ERM has listed in Table 2-1 the guideline values for protection of aquatic life from chronic effects of site-related compounds. None of these values are exceeded, or even approached in Tributary 147. Thus, the ground water discharge and West Well discharge to the tributary do not result in exceeding of any guideline values or standards.

2.4.3 Remedial Action Requirements

Based on the evaluation of potential for public exposure and comparison to surface water standards, no remedial action is necessary in Tributary 147.

2.5 Proposed Remedial Actions

2.5.1 Ground Water Recovery

Based on the foregoing discussions, it is evident that the off-site VOC concentrations are below NYSDEC guidelines and standards, and no potential exists for public exposure to the compounds of concern via the ground water pathway. The only potential for exposure or off-site violation of NYSDEC standards might occur if future increases should occur in off-site migration of the VOC plume in the shallow or deep ground water flow systems. The pumping of the West Well has prevented such

migration, and continued pumping is recommended for containment and retrieval of the VOCs on-site.

This pumping will reduce the on-site VOCs to within NYSDEC standards over time. The period of record of monitoring at wells WW-1, WW-2 and WW-3 indicates a clearly decreasing VOC trend since the remediation of the former solvent storage tank area. Over a period of less than three years, reductions of one order of magnitude have been seen at wells WW-1 and WW-3, and of one-half order of magnitude at well WW-2. If these trends continue, as is expected, the trichloroethene standard should be met within a very few years at the site. Continued monitoring will be necessary to confirm the continuing VOC reduction.

2.5.2 Ground Water Treatment

The discharge of ground water from the West Well overflow has been shown to have a negligible effect on Tributary 147. However, the NYSDEC has indicated that current policy requires treatment to the Best Applicable Technology (BAT) level for VOCs where there is a discharge to surface water under a ground water cleanup program. Thus, the ground water recovered from the West Well must be treated before discharge. This is described in detail in the next Section of this document.

2.5.3 Monitoring

Since the VOC plume is well contained and no ground water standards are exceeded off-site, and since the discharge from the West Well will receive the BAT, an annual monitoring program to track the cleanup progress is recommended. Samples for VOC analysis should be collected at monitoring wells WW-1, WW-2, WW-3, WW-4, WW-5, and WW-6. Monitoring will be performed until the concentrations reach applicable ground water standards. Influent and effluent monitoring for the West Well treatment system will be performed in accordance with SPDES permit requirements.

SECTION 3

GROUND WATER TREATMENT

3.1 Introduction and Statement of Objectives

The Amphenol Corporation facility in Sidney, New York presently has three potable and non-potable water supply sources serving the Plating Building and Main Building. Non-potable water is supplied by two wells, the North Well and West Well, while potable water is supplied by a connection to the Village of Sidney distribution system. Distribution piping within the Main Building is divided into two separate systems, one for potable and one for non-potable supply. North Well and West Well distribution pumps discharge into the non-potable distribution system which can be augmented by a connection to the potable water system, if necessary. The potable water system is isolated from the non-potable system by a series of backflow preventors.

Figure 3-1 presents a schematic of the present water distribution system. The West Well currently delivers between 424,800 to 468,000 gpd, or approximately 295 gpm to 325 gpm. These flow rates were measured during pump tests performed by Amphenol Corp. personnel on 12 March 1987.

Ground water from the West Well is discharged from a single Layne Vertical Centrifugal Turbine pump into a 14,300-gallon holding reservoir located just below grade. Two supply pumps, (also Layne Vertical Centrifugal Turbine pumps), draw from this reservoir and transfer water to the points of use. These pumps discharge to a common header which supplies non-potable water for the Main Building and Plating Building.

Experience with the West Well indicates that a continuous high pumping rate is necessary to minimize fouling of the well screen. Thus, the holding reservoir allows for a constant discharge from the West Well, independent of water demand. The supply pumps are fixed speed and operate continuously. During periods of low water demand, pressure relief valves are activated which provide for recycle of this process water flow back to the holding reservoir. When water demand is below the West Well delivery rate for extended periods, the reservoir overflows through a weir, to a drainage ditch, and from there to Tributary 147.

FIGURE 3-1 AMPHENOL CORPORATION

BENDIX CONNECTOR OPERATIONS
PRESENT SERVICE SCHEMATIC

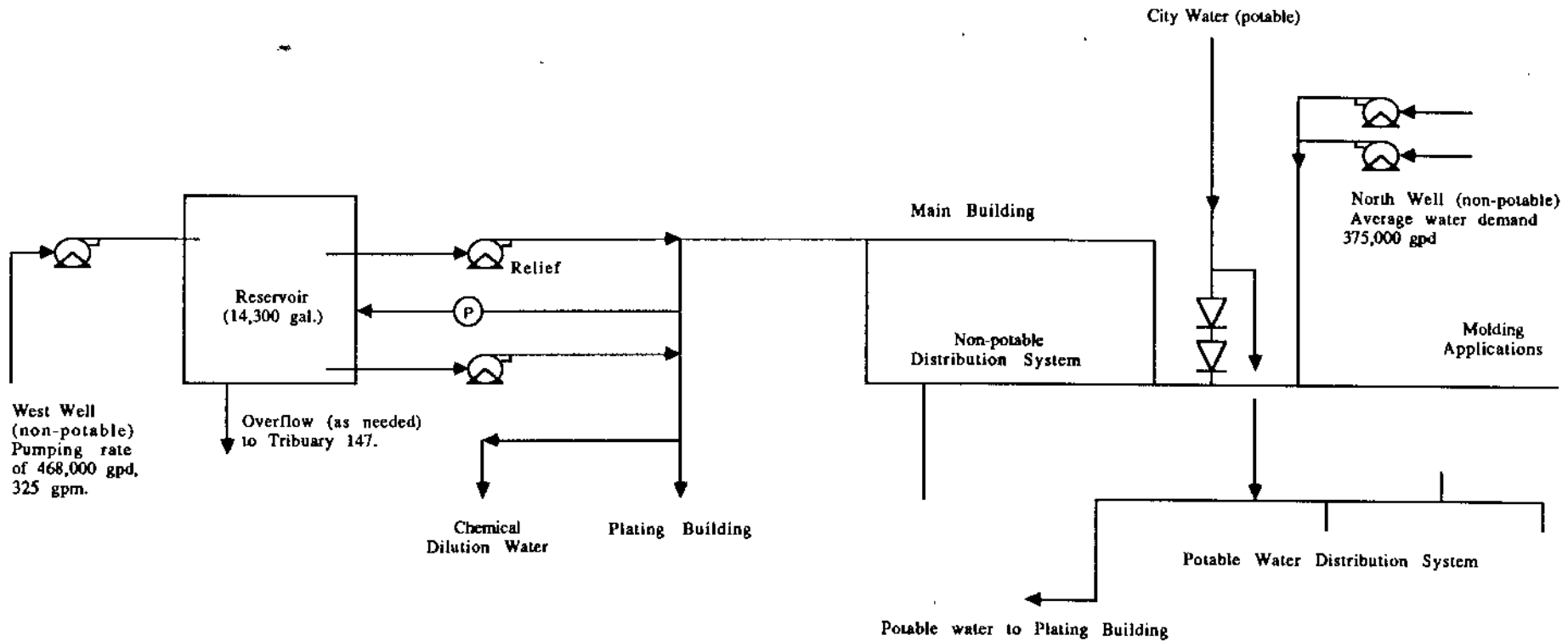

Note:

1. Water demands are presented as daily averages.
2. Above schematic representation of the system does not include all connections, fittings or valves.

Continuous pumping of the West Well will result in containment and remediation of the VOCs in ground water in this area. Based on the previously stated NYSDEC policy for discharge of ground water recovery programs, the objective of the West Well Remediation is to treat the discharge to BAT (Best Applicable Technology) levels. With the overflow to Tributary 147 varying over time due to fluctuating plant water demand, it is recommended that the entire West Well flow be treated to minimize VOC discharge to the surface waters of Tributary 147.

3.2 Treatment Alternatives

The most frequently applied technologies for providing BAT for removal of VOCs from water are carbon adsorption and air stripping. At the West Well flow rate, the size of a carbon adsorption bed required to provide adequate contact time for VOC removal makes that option less cost-effective than air stripping. In addition, the use of an air stripper eliminates the need for replacement or regeneration of the carbon adsorption bed. Thus, air stripping is the treatment method recommended at the West Well.

It should be noted that comprehensive inorganic analysis of West Well discharge water, conducted in December 1986 (Table 3-1), indicates that no readily apparent potential interferences with air stripper operation (such as encrusting by iron and manganese, or fouling by iron bacteria) are present in the water.

3.3 Air Stripping Process Description

Air stripping, also known as desorption, is the physical process in which volatile compounds are transferred from the liquid to the gas phase. The rate and degree of volatile compound transfer depends on the following conditions: (1) the volatility of the compound(s), (2) the ratio of gas flow to liquid flow, (3) the surface area provided by gas:liquid interface, (4) efficiency of gas and liquid mass transfer rates, and (5) the temperature of the liquid.

Air stripping of volatile organic compounds from ground water is most efficiently accomplished by the countercurrent flow of air up through the downward flow of contaminated ground water. A packed tower is employed to enhance the overall efficiency of mass transfer by providing controlled surface area, contact time and air:liquid ratio.

TABLE 3-1
WEST WELL INORGANIC ANALYSES
2 December 1986

pH	7.5
Total Hardness	190 mg/l
Sulfate	26 mg/l
Calcium	56.7 mg/l
Iron	ND
Magnesium	7.6 mg/l
Manganese	0.07 mg/l
Potassium	0.79 mg/l
Sodium	13.9 mg/l

The volatility of a specific compound is reflected by its Henry's Law Constant, which is the ratio of the compound's equilibrium concentration in the gas phase to that in the liquid phase. The greater the value of the Henry's Law Constant, the more readily the compound can be "stripped" from the liquid phase to the gas phase. In practical terms, the greater the Henry's Law Constant is for a given material, the shorter the required packing height for an air stripping column.

The volume of gas necessary to strip the volatile compound(s) from the liquid phase (the gas to liquid ratio) is based on the physical interaction of the two phases. Physical parameters that control transfer from the liquid to the gas phase are: (1) the mass transfer coefficient of the volatile compound(s) within the liquid phase, (2) the mass transfer coefficient of the volatile compound(s) at the gas:liquid interface, and (3) the mass transfer coefficient of the volatile compound(s) within the gas phase. The greater resistance to movement of any of the above transfer coefficients, the more difficult it will be to "strip" a given compound, or compounds. As the overall resistance to mass transfer increases, the height of the packing media required to provide sufficient contact time between the gas and liquid phases increases.

A means of increasing the transfer rate of volatile compound(s) across the gas:liquid interface is to maximize the surface contact of the liquid and gas phases. Means of accomplishing this are: (1) increase the gas flow rate at a constant liquid flow rate and bubble size, (2) decrease the bubble size (increase the number of bubbles) at a constant gas flow rate and liquid flow rate, (3) increase the contact time by increasing the column size at constant gas and liquid flow rates, and (4) improve the packing material to give better gas:liquid contact at constant gas and liquid flow rates. Increased mass transfer rates result in decreased packing depth and decreased air requirements.

The volatility of a compound is affected by temperature. Solubility of gases in liquids increases for most substances as temperature decreases. Therefore, as the temperature of the liquid decreases the volatility of the compound will decrease, requiring greater gas:liquid flow rates, longer contact times, and/or improved packing to maintain the same efficiency as at warmer temperatures.

3.4 Design Conditions

To contain and collect the VOC plume at the West Well, and due to the problem of potential siltation through the well screen, it is projected that the delivery from the West Well will remain at 468,000 gpd (approximately 325 gpm). In order to allow for possible variations in West Well flow, the design flow rate selected for the air stripper is 350 gpm.

The design values for influent organic concentrations for future ground water discharged by the West Well were developed based on projected trends indicated by the sampling program. With the major source of VOCs removed during prior remedial actions (i.e., removal of soils from the former solvent storage tank area, and pavement of the area), the plume concentrations will decrease along their path of flow to the West Well. In addition, the continuous pumping of the West Well should continue to draw in uncontaminated ground water which will further dilute the plume. As shown in Table 3-2, the current VOC concentration at the West Well (as measured 25 November 1986) is 113 ppb. Over the full period of record, analysis of water from the West Well has indicated a slow increase in VOC concentration. However, recent sampling data (refer to Table 1-1) suggest that the VOC concentration has leveled off in the West Well discharge, possibly due to remediation of the principal source area. Therefore, using a conservative design approach, ERM has assumed that the maximum VOC concentration of the West Well discharge might increase to 200 ppb.

In addition, as the previous sampling data indicate that the West Well contains only three VOCs (trans-1,2-dichloroethane, trichloroethene, and 1,1-dichloroethane), it is projected that the design concentration of 200 ppb will also contain only these compounds. The design concentrations presented in Table 3-2 are based on maintaining the same proportional concentrations of the three compounds as detected in the 25 November 1986 samples.

It should be noted that these design values represent a projected worst case and it is possible that actual peak values may remain below these values.

TABLE 3-2
WEST WELL GROUND WATER QUALITY SUMMARY

<u>Organic Component</u>	<u>Historical(1)</u> (ppb)	<u>Current(2)</u> (ppb)	<u>Design(3)</u> (ppb)
Trans-1,2-Dichloroethene	17	22	32
Trichloroethene	110	89	164
1,1-Dichloroethane	2	2	4
Total	129	113	200

-
- (1) Maximum values recorded at West Well for these compounds during sampling period (25 July 1984, 22 February 1986, 25 November 1986).
- (2) Samples collected 25 November 1986.
- (3) Design concentrations based on compounds previously identified in West Well. Refer to text for discussion of design VOC concentrations.

3.5 Design Procedures

3.5.1 Selection of Design Basis by Compound

Packed tower sizing for the West Well site was completed using an algorithm based on work by Onda as expanded by Roberts, et al.¹ The packing material used for the system sizing is 2-inch nominal size Jaeger Tri-Packs, which was selected based on test results from several sources on similar liquid streams.

A design operating temperature of 52.6°F (11.5°C) was assumed to approximate worst case conditions for stripper operation at the site. This design temperature is based on an energy balance performed using an influent ground water temperature estimated at 55°F (13°C) and the minimum air temperature at -10°F (-23°C). For the energy balance, a 100:1 air to water ratio was used. (At an air to water ratio of 50:1, the design operating temperature would be 54.0°F [12.2°C]).

Of the three volatile organic substances detected in the West Well ground water, the two major constituents are trichloroethene, with a "worst case" projected concentration of 164 ppb, and trans-1,2-dichloroethene, projected at 32 ppb. Of these, trichloroethene is not only the predominant compound, but also has the lower Henry's Law Constant and was therefore used for design of the column. The remaining measurable VOC in the West Well discharge, 1,1-dichloroethane, has a Henry's Law Constant that is lower than trichloroethene but is projected at only 4 ppb. Therefore, since it represents only 2 percent of the design VOC level, it was not used as the design compound. Thus, for the design basis it was considered that trichloroethene will be present at a concentration of 200 ppb.

3.5.2 Design Performance

The design basis must also specify the performance, or removal efficiency, expected by the process. Three design removal efficiencies were evaluated to provide a sensitivity analysis of performance vs. column sizing and indirectly, relative cost. The design removal efficiencies evaluated are 90 percent, 95 percent, and 98 percent. The design values and column sizings for the various removal efficiencies are presented in Tables 3-3 and 3-4.

¹Roberts, Paul et al. 1985. "Evaluating Two-Resistance Models for Air Stripping of Volatile Organic Contaminants in a Countercurrent, Packed Column"; Environmental Science and Technology, 1985, Vol. 19: pps 164-173.

TABLE 3-3
 DESIGN BASIS

Flow	350 gpm
Maximum Organic Concentration	200 ppb
Henry's Law Constant	4.2×10^{-3} atm m ³ /mole ⁽¹⁾
Packing Material	Jaeger Tri-Packs (2-inch nominal)
Surface Tension	0.0281 kg/sec ²
Total Specific Surface Area	138/meter
Nominal Packing Diameter	0.0508 meters
Air Temperature (Minimum)	-10°F
Water Temperature (Minimum)	55°F
Material of Construction	PVC or fiberglass
Air/Water Ratio	between 50:1 and 100:1

(1) Value for trichloroethene (TCE) which is the least strippable of the major VOCs projected in the West Well design VOC level at 10°C. The dimensionless Henry's Law Constant is 0.20 under these conditions.

TABLE 3-4
DESIGN SUMMARY

West Well Flow Rate is 350 gpm
Design VOC is Trichloroethene
Packing Media is 2-inch Jaeger Tri-Packs

VOC Percent Removal	Column Diameter (ft)	Packing Height (ft)	Packing Volume (cu ft)	Air:Water Ratio	Liquid Flux (kg/m2/s)	Gas Flux (kg/m2/s)	Stripping Factor
90	3.00	---	---	100	33.67	4.17	19.72
	3.00	---	---	75	33.67	3.12	15.04
	3.00	---	---	50	33.67	2.08	10.20
90	4.00	---	---	100	18.94	2.35	19.72
	4.00	---	---	75	18.94	1.76	15.04
	4.00	8.92	112.09	50	18.94	1.17	10.20
90	5.00	7.80	153.15	100	12.12	1.50	19.72
	5.00	7.86	154.33	75	12.12	1.12	15.04
	5.00	8.06	158.26	50	12.12	0.75	10.20
90	6.00	7.19	203.29	100	8.42	1.04	19.72
	6.00	7.25	204.99	75	8.42	0.78	15.04
	6.00	7.45	210.64	50	8.42	0.52	10.20
95	3.00	---	---	100	33.67	4.17	19.72
	3.00	---	---	75	33.67	3.12	15.04
	3.00	---	---	50	33.67	2.08	10.20
95	4.00	---	---	100	18.94	2.35	19.72
	4.00	---	---	75	18.94	1.76	15.04
	4.00	11.69	146.90	50	18.94	1.17	10.20
95	5.00	10.19	200.08	100	12.12	1.50	19.72
	5.00	10.28	201.85	75	12.12	1.12	15.04
	5.00	10.57	207.54	50	12.12	0.75	10.20
95	6.00	9.39	265.50	100	8.42	1.04	19.72
	6.00	9.48	268.04	75	8.42	0.78	15.04
	6.00	9.77	276.24	50	8.42	0.52	10.20
98	4.00	---	---	100	18.94	2.35	19.72
	4.00	---	---	75	18.94	1.76	15.04
	4.00	15.38	193.27	50	18.94	1.17	10.20
98	5.00	13.35	262.13	100	12.12	1.50	19.72
	5.00	13.49	264.88	75	12.12	1.12	15.04
	5.00	13.91	273.12	50	12.12	0.75	10.20
98	6.00	12.31	348.06	100	8.42	1.04	19.72
	6.00	12.44	351.73	75	8.42	0.78	15.04
	6.00	12.84	363.04	50	8.42	0.52	10.20

A review of Table 3-4 provides the following information:

- Column diameters in excess of four feet are required to provide sufficient media area to maintain the liquid flux and gas flux rates within acceptable limits. The liquid flux rate should range between 0.5 and 30 kg/m²/sec so that the ground water distributes evenly across the media. The gas flux rate should range between 0.017 and 0.17 kg/m²/sec. Operating within these ranges will provide sufficient gas:liquid interface and permit efficient stripping.

In addition, the stripping factor should be greater than one for proper operation of the column. The stripping factor is determined by multiplying the non-dimensional Henry's Law Constant by the Volumetric A:W ratio. When this factor is above one there is sufficient air to remove the VOCs from the liquid phase. If the stripping factor falls below one, then the algorithm used to determine the packing media height (through a calculation of the number and height of transfer units required) fails.

- Operation of a properly sized column with as small a blower as possible is preferred, as the electrical requirements will be decreased. As shown in the table, the required media depth for a given percent removal and increases only slightly for a decrease in the A:W ratio from 100:1 to 50:1. Thus, energy savings can be realized over the long term for the relatively insignificant up-front cost of a slightly higher packed column.
- An increase in stripping tower diameter for a given A:W ratio does not substantially reduce the required media height but does substantially increase the packing volume. To design the proper foundation or support structure it is necessary to design for a flooded stripper column. The increased packing volume results in a greater design load on the support structure. Thus, a small diameter column is preferable.
- The design VOC removal rate is independent of the inlet design concentration at the concentrations anticipated from the West Well discharge. In reality, VOC removal efficiencies start becoming affected only as the concentration approaches the solubility limit of the compound(s) in the liquid stream. Under these extreme

conditions a stripper would be seeing a two phase solution that behaves substantially differently from a soluble substrate. The compounds identified in the West Well discharge are several orders of magnitude below their solubility limits and therefore the percent removal calculations are independent of anticipated inlet concentrations.

3.6 Recommended Design of Air Stripper

Calculations were performed to size air strippers for the 90 percent, 95 percent, and 98 percent removal of VOCs from the ground water. Based on a comparison of the proposed systems, ERM recommends that a 4-foot diameter column with an air:water ratio of 50:1 be installed. The bases for this recommendation are:

- Based on the requirement that the column support must be designed to carry a flooded column, this design minimizes the design loading.
- Operation of the stripper with a 50:1 air:water ratio will minimize power requirements and therefore minimize yearly operating costs.
- Based on the design VOC concentration of 200 ppb, a column designed for 90 percent removal would have a finished water concentration of 20 ppb; a column designed for 95 percent removal would have a finished water concentration of 10 ppb; and a column designed for 98 percent removal would have a finished water concentration of 4 ppb. The selected removal efficiency affects the required packing depth for a 4-foot diameter column, over a range from 8.92 to 15.38 feet, between 90 percent and 98 percent removal. Since the cost differential over this column-height range is small, ERM recommends that a 98 percent removal column be specified to provide the BAT required by the NYSDEC. This column will provide remediation of the design ground water (inlet concentration 200 ppb) to a finished concentration of 4 ppb; or for the current ground water (inlet VOC concentration 113 ppb) to approximately 2 ppb.

The recommended air stripper is designed for a flow of 350 gpm, is 4-feet in diameter, has media packing of 15 feet, and has an air-to-water ratio of 50:1. This unit will have an overall

height of approximately 20 feet and will remove 98 percent of the inlet VOCs.

3.7 Air Emission Analysis

At an air flow rate of 50:1 (2350 scfm at the design flow rate of 350 gpm) and a design concentration of 200 ppb, the off-gas concentrations for the three components are all acceptable based on calculations performed in accordance with the "New York State Air Guide - 1, Guidelines for the Control of Toxic Ambient Air Contaminants", July 1986 printing. These calculations were performed using a conservative analysis based on the following assumptions:

- The design concentration of 200 ppb was used.
- It was assumed that the stripper removed all 200 ppb which is then discharged to the surrounding atmosphere from a point source.

Under the procedure outline in the NYS Air Guide-1, page 12, for point sources the first step is to establish the toxicity and corresponding AALs (Acceptable Ambient Levels) for all contaminants under consideration. Of the three VOCs under consideration at this site only one, trichloroethene, has a specified AAL at 900 ug/m³. For the two remaining compounds trans-1,2,-dichloroethane and 1,1-dichloroethane the minimum AAL for moderate to low toxicity compounds without TWA-TLVs (Threshold Limit Value - Time Weighted Averages) was used. This value is 0.03 ug/m³.

The second step of the analysis is to determine the "in-stack" concentration of each contaminant. This was performed by a mass balance based on the design concentrations, assuming that the entire VOC load is transferred to the air stream at the air flow rate of 2350 scfm. The in-stack concentration level is then divided by 100, to account for atmospheric dispersion, as per the guidelines. This value is then compared with the AALs.

From a review of Table 3-5, it can be seen that the calculated atmospheric concentrations using the design concentrations for the three design VOCs are all well below the AALs. Under the guidelines no further analysis is required and off-gas treatment is also not required.

TABLE 3-5

AIR EMISSION ANALYSES

<u>Compound</u>	<u>Design Concentration in Ground Water</u>	<u>AALs(1)</u>	<u>Calculated Atmospheric Concentration(3)</u>
trans-1,2-dichloroethene	32 ppb	0.03 ug/m ³ (2)	0.0016 ug/m ³
trichloroethene	164 ppb	900 ug/m ³	0.0061 ug/m ³
1,1-dichloroethane	4 ppb	0.03 ug/m ³ (2)	0.0002 ug/m ³

(1) Acceptable Ambient Levels as presented in NYS Air Guide-1, Guidelines For the Control of Toxic Ambient Air Contaminants, July 1986 printing.

(2) De minimus AALs for moderate and low toxicity contaminants without TWA-TLVs (Threshold Limit Value - Time Weighted Analyses)

(3) Based on procedures outlined on page 12 of the NYS Air Guide-1, Guidelines For the Control of Toxic Ambient Air Contaminants, July 1986 printing. Under this procedure the concentration in the off-gas is divided by 100 to account for atmospheric dispersion and then is compared with the AALs. As noted, the off-gas concentrations are below the AALS, so under the guidelines no further analysis is required and no off-gas treatment is required.

3.8 Physical Layout

3.8.1 Location

The air-stripper installation will require one stripper column with packing, a booster lift pump, an air blower, and the necessary controls. Pumping to the stripper will be performed by the existing Layne Vertical Centrifugal Turbine Pump which will be boosted by an in-line centrifugal pump. Modification of the existing West Well pump to discharge directly to the top of the air stripper would be costly and difficult, as the Layne Centrifugal Pump has a rather flat pump curve. Presently, the pump is discharging at approximately 315 gpm at a static lift of about 80 feet.

In order to limit space requirements, ideally the air stripper will be positioned over the existing West Well holding reservoir. Positioning the stripper here will require few piping modifications due to its close proximity to the existing West Well pump. In addition, all controls and electrical connections can be located within the existing West Well building. The blower and booster pump can also be positioned near the existing structure and can be enclosed in removal structures that protect the equipment from the elements but can be easily removed for servicing the equipment.

A review of the pile and pile-cap plan for the West Well pump building and holding reservoir indicates that a total of fifteen piles are positioned under the holding reservoir. These piles are laid out in three rows of five piles, placed equidistant and perpendicular to the holding reservoir's length. Based on field measurements of the piles taken in 1943, the piles beneath the holding reservoir are capable of carrying a load of 191.6 tons. Presently, the holding reservoir load, including water, is 165 tons. Therefore, as a conservative estimate, the piles and pile caps beneath the holding reservoir are capable of handling an additional load of 25 tons.

Design load for the air stripper is based on a 4-foot diameter column, 20 feet in height. The greatest load would occur if the column flooded with water, resulting in a total load of less than 10 tons. While it is unlikely the column would flood during normal operation, standard industry practice is to design for this condition. Possible conditions that could result in a flooded column are: (1) freezing of the discharge line, (2) clogging of the discharge line due to broken media, etc., and (3) closure of the discharge valve (underdrain) of the column while the feed pump was still operating.

A base support system must be designed to permit the transfer of the column load to the reservoir side walls, as the reservoir cover cannot be expected to support the load. Detailed structural evaluation is necessary to ascertain the best method of support. This will be performed during the detailed engineering design phase. Based on review of the support system necessary to carry a flooded column load, it may prove more economical to build a separate air stripper foundation in the vicinity of the holding reservoir. Detailed cost comparisons will also be performed during the engineering design phase.

3.8.2 System Description

The addition of the air stripper to the existing distribution system will be accomplished in the following fashion (refer to Figure 3-2). The discharge line for the West Well pump will be modified, with the present discharge elbow from the West Well pump removed and replaced with a tee fitting. One end of the tee will remain directed toward the holding reservoir while the other will be directed toward the Pump Room wall. Both extensions will have manually operated valves to permit control of flow direction. Under operating conditions, the line to the reservoir will be closed. An opening in the Pump Room wall will permit the other line to exit the building. Outside the building, above the holding reservoir, the line will connect to an in-line centrifugal booster pump to lift the West Well flow to the top of the air stripper column. The centrifugal pump and motor can be enclosed in a small shed to protect the electrical equipment.

The proposed piping modifications would permit the West Well flow to enter the holding reservoir directly in the event that (1) the air stripper is off-line for maintenance, or (2) the organic concentration of the ground water decreases so that stripping is no longer required. Positioning the centrifugal pump in-line will require that the centrifugal pump be interlocked with the West Well pump so that it will shut down if the West Well pump shuts down.

For discharge from the bottom of the air stripping column, a discharge line can extend down through the holding reservoir roof. An alternative option would be to place the underdrain line through the same wall opening as the booster pump line. This would eliminate the need to bore through the reservoir roof, which may affect the structural integrity of the concrete slab.

It is possible that the stripper blower could be positioned on the holding reservoir roof next to the air stripper and protected

FIGURE 3-2
AMPHENOL CORPORATION
BENDIX CONNECTOR OPERATIONS
AIR STRIPPER SERVICE SCHEMATIC

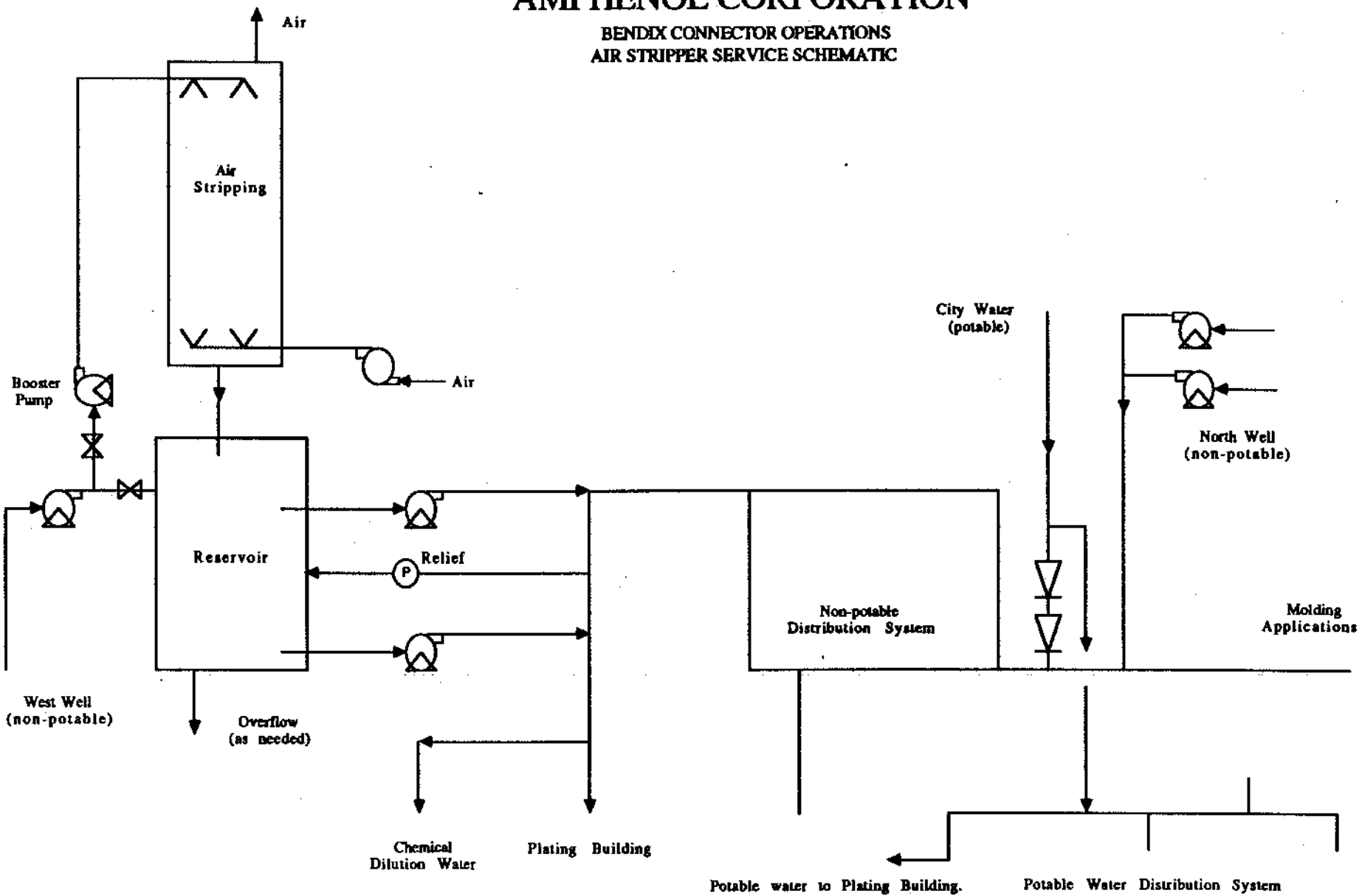

Note:
 1. Above schematic representation of system does not include all connections, fittings or valves.

from the elements by a small enclosed structure. (Refer to Figures 3-3 and 3-4). However, possible vibration of the air blower may require construction of an isolated foundation slab.

Piping the system in the manner described above will allow for treatment of the entire West Well flow, using the existing holding reservoir to hold the treated (i.e. "stripped") ground water. The existing non-potable distribution system to the Main Building and Plating Building will be maintained, with overflow from the holding reservoir to Tributary 147 treated.

Insulation of the air stripping column and associated piping is not required based on energy balance calculations. To ensure that the operation of the system is unaffected during the winter, it is recommended that the inlet and discharge lines be heat traced. During operation, the latent heat in the ground water will be sufficient to prevent freezing down to air temperatures below approximately -10°F (-23°C). For possible maintenance during freezing conditions, a drain line should be provided to permit dewatering of the booster pump and feed line.

FIGURE 3-3
AMPHENOL CORPORATION
BENDIX CONNECTOR OPERATIONS
WEST WELL-PLAN VIEW

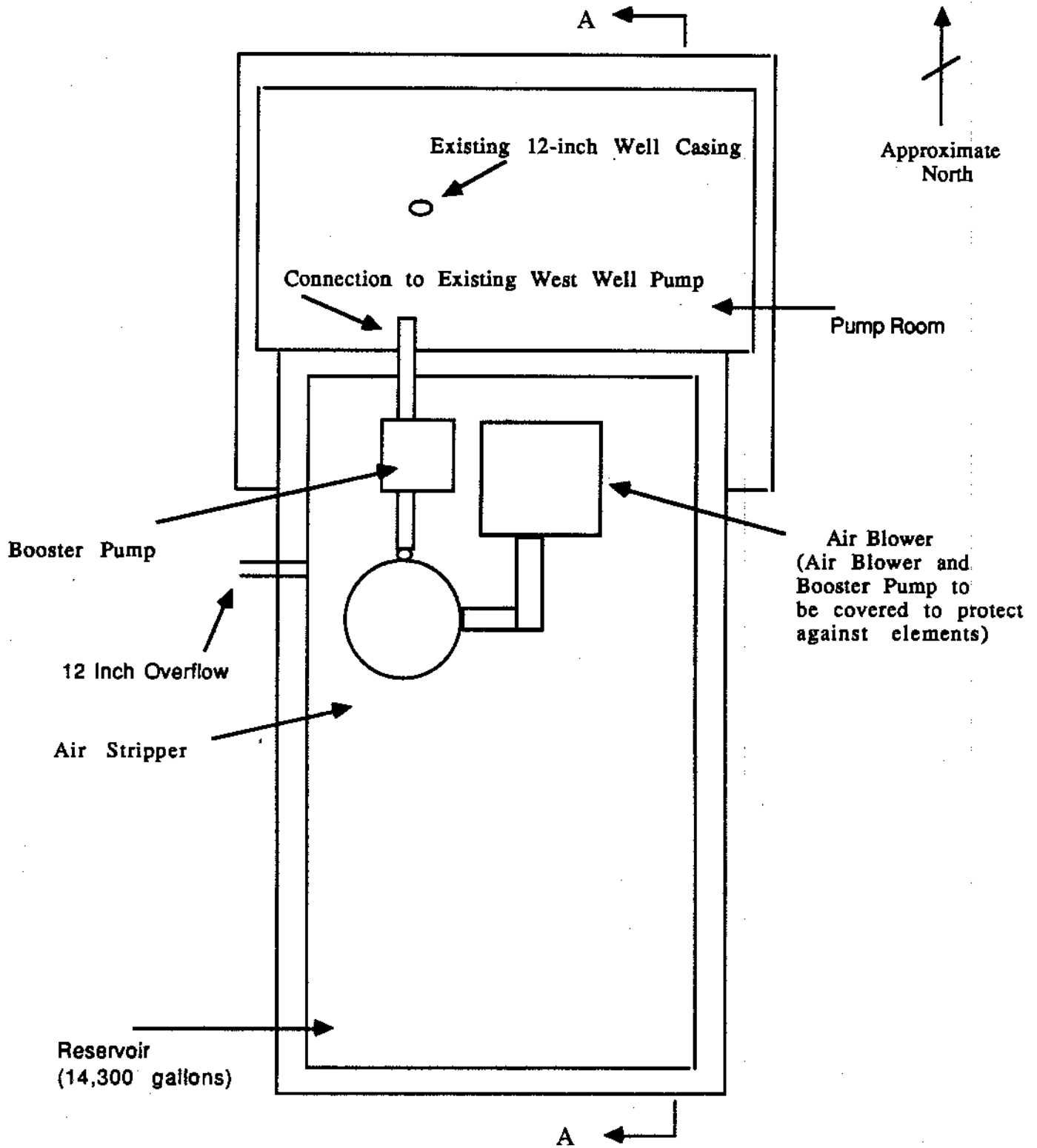

Note: Approximate scale is 1-inch equals 5-feet

FIGURE 3-4
AMPHENOL CORPORATION
BENDIX CONNECTOR OPERATIONS
WEST WELL-SECTION "AA"

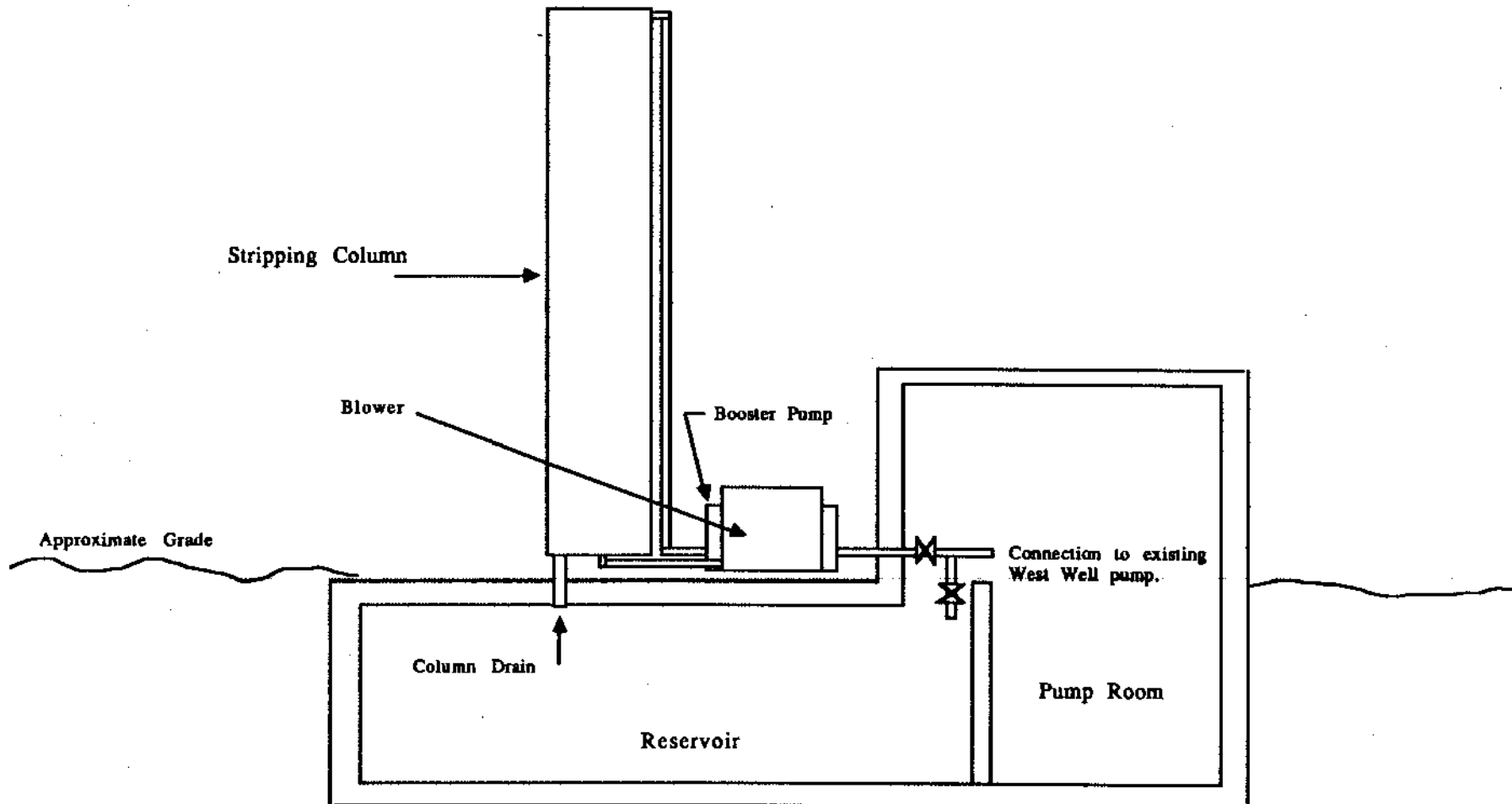

Note:
Approximate scale 1-inch = 6.7-feet.

TABLE 3-6
EQUIPMENT LIST

Air Stripping System

Column

Function: Remove 98% of volatile organic constituents from ground water

Design Basis: Air: water ratio = 50:1
Design temperature = 54°F (12°C)
Design VOC concentration = 200 ppb of trichloroethene

Number: One, approximately 20 ft high, 4 ft diameter

Capacity: 350 gpm, maximum

Type: Packed tower, 12 ft of 2" diameter Jaeger Tri-Packs

Material: FRP tower, Polypropylene packing

Blower

Function: Provide air flow to stripping tower

Design Basis: Air: water ratio = 50:1 at a water flow rate of 350 gpm (2350 scfm)

Number: One

Capacity: Centrifugal Blower

Material: Steel, TEFC

Control: On/Off

SECTION 4

CONCLUSIONS AND RECOMMENDATIONS

Based on the foregoing discussion, the following conclusions and recommendations are presented:

4.1 Conclusions

1. The pumping of the West Well at approximately 350 gpm has prevented any off-site VOC migration in excess of New York State Ground Water Standards.
2. The reconstruction of the former solvent storage tank area and the associated soil removal have remediated the principal source area of VOCs to the ground water at the West Well.
3. Continued pumping of the West Well contains the VOCs on site so that no NYSDEC standards are violated off-site, and reduces the VOC concentrations in the on-site ground water.
4. There is no potential public health risk associated with the VOCs in ground water under the current conditions.
5. There is no potential public or environmental impacts associated with the West Parking Lot soils or sediments in Tributary 147.
6. The ground water and West Well discharges to Tributary 147 are in compliance with New York State standards for the designated Class D waters.
7. The NYSDEC current policy requires that Best Applicable Technology (BAT) be applied to ground water recovered under an aquifer restoration program.
8. The most cost-effective BAT method at the West Well is countercurrent air stripping before the distribution reservoir.

4.2 Recommendations

1. The current pumping schedule should be maintained at the West Well in order to contain and recover the VOC plume at the site.
2. Countercurrent air stripping of the water from the West Well should be implemented to provide BAT.
3. Annual monitoring should be conducted at monitoring wells WW-1, WW-2, WW-3, WW-4, WW-5, and WW-6. Monitoring will be performed until the concentrations reach applicable ground water quality standards.