



## FEASIBILITY STUDY

---

WORK ASSIGNMENT D004433-14

KLIEGMAN BROTHERS SITE OU2  
GLENDALE

SITE NO. 2-41-031  
QUEENS (C) NY

Prepared for:  
NEW YORK STATE  
DEPARTMENT OF ENVIRONMENTAL CONSERVATION  
625 Broadway, Albany, New York

Alexander B. Grannis, Commissioner

DIVISION OF ENVIRONMENTAL REMEDIATION

URS Corporation  
77 Goodell Street  
Buffalo, New York 14203

FINAL  
February 2008

**FEASIBILITY STUDY**

**KLIEGMAN BROS. SITE  
OPERABLE UNIT NO. 2  
SITE #2-41-031  
QUEENS, NEW YORK**

**Prepared for:**

**NEW YORK STATE DEPARTMENT OF ENVIRONMENTAL CONSERVATION  
DIVISION OF ENVIRONMENTAL REMEDIATION  
WORK ASSIGNMENT D004433-14**

**Prepared by:**

**URS CORPORATION  
77 GOODELL STREET  
BUFFALO, NEW YORK 14203**

**JANUARY 2008**

## TABLE OF CONTENTS

	<u>Page No.</u>
1.0 INTRODUCTION .....	1-1
1.1 Scope.....	1-1
1.2 Site Description and History.....	1-1
1.3 Previous Investigations and Interim Remedial Measures .....	1-2
1.4 Site Hydrogeology .....	1-4
1.5 Extent of Contamination.....	1-5
1.5.1 Soil Gas.....	1-5
1.5.2 Groundwater .....	1-6
1.6 Exposure Pathways.....	1-8
1.7 Indicator Parameters .....	1-8
2.0 DEVELOPMENT OF REMEDIAL ALTERNATIVES .....	2-1
2.1 Remedial Action Objectives.....	2-1
2.2 General Response Actions.....	2-2
2.3 Identification of Volumes or Areas of Media to be Addressed .....	2-3
2.3.1 Soil Gas.....	2-3
2.3.2 Groundwater .....	2-3
2.4 Identification of Technologies .....	2-4
2.4.1 No Additional Action for Soil Gas and/or Groundwater .....	2-4
2.4.2 Exposure Point Mitigation.....	2-5
2.4.3 Containment Technologies .....	2-6
2.4.4 Treatment Technologies .....	2-9
2.4.4.1 Constructed Treatment System for Extracted Groundwater.....	2-9
2.4.4.2 Off-site Treatment of Extracted Groundwater.....	2-11
2.4.4.3 In-well Treatment System.....	2-11
2.4.4.4 In Situ Biological Treatment .....	2-12
2.4.5 In Situ Chemical Oxidation Treatment.....	2-13
2.4.6 In Situ Physical/Thermal Treatment.....	2-23
2.5 Development of Alternatives .....	2-24
2.5.1 Alternative 1 – No Additional Action.....	2-24
2.5.2 Alternative 2A – Groundwater Extraction from Concentrated Plume Area with Above-Ground Water Treatment.....	2-25
2.5.3 Alternative 2B – Groundwater Extraction from Expanded Plume Area with Above-Ground Water Treatment.....	2-26
2.5.4 Alternative 3A – In Situ Chemical Oxidation Treatment of Concentrated Plume Area .....	2-27

2.5.5	Alternative 3B – In Situ Chemical Oxidation Treatment of Expanded Plume Area .....	2-29
2.5.6	Alternative 4 - In Situ Chemical Oxidation Treatment of Concentrated Plume Area with Induced Groundwater Gradient.....	2-30
3.0	DETAILED DESCRIPTION AND ANALYSIS OF ALTERNATIVES .....	3-1
3.1	Description of Evaluation Criteria.....	3-1
3.2	Alternative 1 – No Additional Action.....	3-3
3.2.1	Description.....	3-3
3.2.2	Overall Protection of Human Health and the Environment.....	3-4
3.2.3	Compliance with SCGs.....	3-4
3.2.4	Short-Term Impacts and Effectiveness .....	3-5
3.2.5	Long-Term Effectiveness and Permanence .....	3-5
3.2.6	Reduction of Toxicity, Mobility, and Volume.....	3-5
3.2.7	Implementability.....	3-5
3.2.8	Cost.....	3-6
3.3	Alternative 2A – Groundwater Extraction from Concentrated Plume Area With Above-Ground Water Treatment .....	3-6
3.3.1	Description.....	3-6
3.3.2	Overall Protection of Human Health and the Environment.....	3-7
3.3.3	Compliance with SCGs.....	3-8
3.3.4	Short-Term Impacts and Effectiveness .....	3-8
3.3.5	Long-Term Effectiveness and Permanence .....	3-8
3.3.6	Reduction of Toxicity, Mobility, and Volume.....	3-9
3.3.7	Implementability.....	3-9
3.3.8	Cost.....	3-10
3.4	Alternative 2B –Groundwater Extraction from Expanded Plume Area with Above-Ground Water Treatment .....	3-10
3.4.1	Description.....	3-10
3.4.2	Overall Protection of Human Health and the Environment.....	3-11
3.4.3	Compliance with SCGs.....	3-12
3.4.4	Short-Term Impacts and Effectiveness .....	3-12
3.4.5	Long-Term Effectiveness and Permanence .....	3-12
3.4.6	Reduction of Toxicity, Mobility, and Volume.....	3-13
3.4.7	Implementability.....	3-13
3.4.8	Cost.....	3-14
3.5	Alternative 3A – In Situ Chemical Oxidation Treatment of Concentrated Plume Area .....	3-14
3.5.1	Description.....	3-14
3.5.2	Overall Protection of Human Health and the Environment.....	3-16

3.5.3	Compliance with SCGs.....	3-17
3.5.4	Short-Term Impacts and Effectiveness.....	3-17
3.5.5	Long-Term Effectiveness and Permanence .....	3-18
3.5.6	Reduction of Toxicity, Mobility, and Volume.....	3-19
3.5.7	Implementability.....	3-19
3.5.8	Cost.....	3-20
3.6	Alternative 3B – In Situ Chemical Oxidation Treatment of Expanded Plume Area.....	3-20
3.6.1	Description.....	3-20
3.6.2	Overall Protection of Human Health and the Environment.....	3-23
3.6.3	Compliance with SCGs.....	3-23
3.6.4	Short-Term Impacts and Effectiveness.....	3-23
3.6.5	Long-Term Effectiveness and Permanence .....	3-24
3.6.6	Reduction of Toxicity, Mobility, and Volume.....	3-25
3.6.7	Implementability.....	3-26
3.6.8	Cost.....	3-26
3.7	Alternative 4 - In Situ Chemical Oxidation Treatment of Concentrated Plume Area with Induced Groundwater Gradient.....	3-26
3.7.1	Description.....	3-26
3.7.2	Overall Protection of Human Health and the Environment.....	3-30
3.7.3	Compliance with SCGs.....	3-31
3.7.4	Short-Term Impacts and Effectiveness.....	3-31
3.7.5	Long-Term Effectiveness and Permanence .....	3-32
3.7.6	Reduction of Toxicity, Mobility, and Volume.....	3-33
3.7.7	Implementability.....	3-34
3.7.8	Cost.....	3-34
3.8	Summary.....	3-34
4.0	COMPARATIVE ANALYSIS OF ALTERNATIVES.....	4-1
4.1	Overall Protection of Human Health and the Environment.....	4-1
4.2	Compliance with SCGs.....	4-2
4.3	Short-Term Impacts and Effectiveness.....	4-2
4.4	Long-term Effectiveness and Permanence.....	4-2
4.5	Reduction of Toxicity, Mobility, and Volume.....	4-3
4.6	Implementability.....	4-4
4.7	Cost.....	4-4
5.0	RECOMMENDED REMEDIAL ALTERNATIVE.....	5-1

## **TABLES**

(Following Text)

Table 1-1	Summary of PCE Concentrations (ppb) in Groundwater Samples
Table 2-1	Technology Screening Summary
Table 3-1	Summary of Estimated Costs
Table 3-2	Summary of Air Stripping Requirements
Table 3-3	Evaluation of Alternatives

## **FIGURES**

(Following Tables)

Figure 1-1	Site Location Map
Figure 1-2	Site Plan
Figure 1-3	IRM Site Plan
Figure 1-4	PCE Concentrations in Shallow Groundwater
Figure 1-5	PCE Concentrations in Deep Groundwater
Figure 2-1	Groundwater Treatment Process
Figure 3-1	Layout for Alternative 1
Figure 3-2	Conceptual Layout for Alternative 2A
Figure 3-3	Conceptual Layout for Alternative 2B
Figure 3-4	Conceptual Layout for Alternative 3A
Figure 3-5	Conceptual Layout for Alternative 3B
Figure 3-6	Conceptual Layout for Alternative 4

## **APPENDICES**

Appendix A	Groundwater Calculations
Appendix B	Cost Estimates
Appendix C	New York City Department of Environmental Protection Discharge Limitations

## **1.0 INTRODUCTION**

### **1.1 Scope**

This Feasibility Study (FS) presents the evaluation of alternatives for the remediation of Operable Unit No. 2 (OU2) at the Kliegman Brothers Site (Site No. 2-41-031) in Queens County, New York. This work is being performed for the New York State Department of Environmental Conservation (NYSDEC) under Task 2 of Work Assignment D004433-14.

A Focused Feasibility Study for the remediation of Operable Unit No. 1 (OU1) at the Kliegman Brothers Site performed under Task 5 of Work Assignment D003825-37 resulted in a Record of Decision (ROD) issued in March 2006. The ROD remedy for OU1 addressed on-site soil and soil vapor contamination. These included the site impacts with respect to contaminated soils in the vadose zone soil, that is, soil above the water table and the perched water area located on the eastern portion of the site within the vadose zone, the release of contaminants from soil into groundwater, and the release of contaminants from soil vapor into indoor air through vapor intrusion.

This OU2 FS will address impacts to off-site soil gas and impacts to both on-site and off-site groundwater.

### **1.2 Site Description and History**

The site is situated in a densely populated urban mixed-use residential/light-commercial setting. The Kliegman Brothers property is located at 76-01 77th Avenue in Queens County, New York (Figure 1-1) and is bordered to the north by the Long Island Railroad. The off-site area includes residences that are present to the east, west, and south; Public School (P.S.) 119 lies to the west of 75th street. The on-site property is approximately 37,000 square feet, of which 26,000 is occupied by a building (Figure 1-2). A basement exists under the western portion of the building.

Kliegman Bros Inc formerly owned the on-site property. This property was used as a warehouse and distribution center for laundry and dry-cleaning supplies from the 1950s through the 1990s. Two 6,000-gallon above-ground storage tanks (ASTs) were used to store tetrachloroethene (PCE) (Figure 1-2). The tanks have since been removed from the property. Although these tanks are the presumed source of contamination, it is unknown if, and when, product was released or, whether contamination was due to a single catastrophic release or a chronic leak problem. Kliegman Bros. ceased operation in 1999. The property was purchased in 2000 and is currently being used as a warehouse for an imported food distributor. Known contamination is unrelated to operations since 2000.

### **1.3 Previous Investigations and Interim Remedial Measures**

Soil and/or soil gas sampling has been performed from 1997 through 2006 as part of the RI and continues in 2007. The initial investigations were performed by Tradewinds Environmental Restoration, Inc. and Advanced Cleanup Technologies (ACT) in 1997 and 1998, respectively. These investigations were comprised of soil gas collection and analysis in the area between the building and the railroad where the PCE storage tanks were located. Additional soil gas sampling was performed by EEA, Inc. (for a prospective property owner) and by URS (for NYSDEC) in 2000. All of these investigations revealed the presence of PCE, often at high concentrations. Enviroscience Consultants, Inc. performed an investigation in 2001 as part of a Voluntary Cleanup Plan (VCP) agreement with NYSDEC, and included soils and groundwater sampling as part of a Focused Remedial Investigation/Interim Remedial Measures (FRI/IRM). The objective of the FRI/IRM was to sufficiently delineate on-site soil contamination to enable the design of a soil vapor extraction (SVE) system to remediate on-site soil. As part of the study, Enviroscience Consultants, Inc. advanced nine borings, SVE-1 through SVE-5 and EB-1 through EB-4. Enviroscience also collected 26 soil samples from beneath the subfloor of the building, approximately 0-12 inches below the concrete floor/soil interface.

Between October 2000 and August 2001, the New York State Department of Health (NYSDOH) conducted ambient air sampling in 17 residences east, west, and south of the property. NYSDOH sampled on five occasions, although individual residences were sampled only one to three times each. Vapors were detected in 16 of the 17 residences tested.



In September 2002, the property owner discontinued his participation in the VCP and thus responsibility for addressing on-site subsurface contamination reverted to NYSDEC. Because of documented ongoing PCE vapor exposures to adjacent residences, NYSDEC tasked URS to implement an SVE system as an interim remedial measure (IRM).

URS completed construction of an SVE system at site as an IRM in 2004. The system utilizes three extraction wells (SVE-1, SVE-6S and SVE-6D) as shown on Figure 1-3. SVE-1 is a one-inch diameter well screened from 5 to 25 feet below ground surface (bgs). Wells SVE-6S and 6D are two-inch diameter wells screened from 5 to 25 feet bgs (SVE-6S) and 30 to 65 feet bgs (SVE-6D). SVE-6S and SVE-6D are separate wells installed at the same location. Other wells (SVE-2 through 5), originally installed by Enviroscience as SVE wells, were not used for the IRM. The three wells are connected through a subsurface trench to the SVE system consisting of a moisture separator, an extraction blower, and vapor phase carbon vessels. The extraction blower is an approximately 250 standard cubic feet per minute (scfm), 5 horsepower regenerative blower, and the two carbon vessels each contain 1,000 pounds of carbon. Operation of the system began on August 23, 2004. Between August 23, 2004 and June 14, 2006 (the date of the last report) the SVE system removed approximately 35,800 pounds of PCE from the vadose zone.

Groundwater sampling has been performed since 2001. Enviroscience Consultants, Inc. performed groundwater sampling and analysis for VOCs as part of the FRI/IRM. Groundwater samples were obtained from each of the SVE borings except SVE-1. Samples were collected from the regional water table using a hydropunch sampler just below the water table (i.e., 70 feet deep) and approximately 30 feet below the water table.

URS included groundwater sampling results within the Remedial Investigation Report issued in February 2004. However, since the groundwater plume was not fully characterized, additional monitoring wells were installed in order to further delineate the extent of groundwater contamination. URS subsequently issued an RI Addendum Report in September 2005 summarizing the results of the additional fieldwork, which included the installation and sampling of 8 new monitoring wells, both on-site and off-site, as well as the sampling of 16 of the 18

existing wells. (MW-10D and MW-10H were not sampled because they were partially obstructed by new asphalt paving.)

URS conducted a residential air-sampling program during 2005 and 2006, which continues in 2007, as an additional part of the RI to determine if the PCE plume has resulted in soil vapor entering area residences. Results are presented in the 2006 URS report for NYSDEC entitled *Soil Vapor Intrusion Investigation Report*. Based on the findings of completed soil vapor intrusion pathways obtained during the initial (February 2005) sampling program, the indoor air-sampling program was expanded as part of the IRM. The extent of the full program included indoor air and sub-slab sampling at 70 residences and P.S. 119 based on their proximity to the site. Sampling followed the NYSDOH 2005 Draft Guidance for Evaluating Soil Vapor Intrusion in the State of New York. Based on the analytical data collected, the NYSDEC in concurrence with the NYSDOH determined that 12 residences were eligible for installation of sub-slab depressurization systems.

#### **1.4 Site Hydrogeology**

Site-specific geology was obtained from boring logs. In general, beneath a fill layer (concrete or asphalt underlain by reworked native materials) of variable thickness (up to 2 feet), brown loose to dense, fine to coarse silty sand to sandy silt with localized sandy clay seams was observed to depths of approximately 10 feet bgs. This was underlain by brown loose to dense, fine to coarse sand with variable amounts of fine to coarse gravel to a depth of 148 feet bgs. This unit appears to correlate to the Upper Pleistocene glacial deposits and the more recent Holocene deposits. Beneath the eastern portion of the property a brown silty clay layer, with variable amounts of sand was present. This silty clay layer occurs at approximately 10 to 15 feet bgs and is approximately 5 feet thick until it appears to pinch out in the vicinity of MW-04D. Perched groundwater was observed above the silty clay layer at a depth of 10 to 12 feet bgs.

Measurements of groundwater elevations from the network of monitoring wells were used to develop groundwater contour maps and determine the site-specific direction of

groundwater flow at three groundwater depths: perched groundwater, shallow groundwater at the water table, and deep groundwater approximately 30 to 40 feet below the water table.

The groundwater table occurs at the site at approximately 70 feet bgs within the upper glacial aquifer. No public water supplies draw water from this source. Horizontal hydraulic gradients in shallow groundwater are very gentle. Groundwater flow direction varied from northerly to southerly and therefore, in general, the groundwater flow direction in shallow groundwater was determined to be variable, possibly due to the very gentle horizontal hydraulic gradients and seasonal fluctuations in the water table. Slug test results conducted as part of the RI indicated an average hydraulic conductivity of approximately  $5 \times 10^{-2}$  cm/sec. However, the overall conductivity is probably much higher because data from several slug tests were not measurable due to a very fast recharge rate. Measured hydraulic conductivity values were generally one to two orders of magnitude higher in water table wells compared to wells in perched groundwater.

Deep groundwater is considered to be approximately 30 to 40 feet below the water table. The horizontal hydraulic gradient was nearly flat. There is little to no discernible vertical hydraulic gradient observed between the deep and shallow groundwater wells.

## **1.5 Extent of Contamination**

### **1.5.1 Soil Gas**

URS performed an extensive on-site soil gas survey in 2002 the results of which were summarized in the RI. High concentrations of PCE were detected at all locations on-site. As discussed above, between August 2004 and June 2007 the SVE system removed approximately 39,000 pounds of PCE from the vadose zone. The additional SVE treatment system and new extraction wells outlined in the OU1 ROD are anticipated to handle about three times the amount of extracted soil vapor as the current IRM.

VOCs have also migrated offsite in soil gas as evidenced by the detection of vapors in residences tested. Due to the depth of groundwater and the presence of lenses of relatively less permeable material within the aquifer, the source of the soil gas contamination is mainly contamination in vadose zone soil. A vapor intrusion mitigation program, comprising of the installation of the sub-slab depressurization systems at individual residences, has been implemented.

### **1.5.2 Groundwater**

Perched groundwater is present on-site but is included in the OU1 portion of the site. This OU2 Feasibility Study addresses non-perched, water table, groundwater.

Groundwater sampling results from Enviroscience Consultants, Inc. and URS indicate that contamination has migrated offsite through groundwater in all directions. Reported concentrations of VOCs in groundwater are above New York State Class GA criteria. In most monitoring wells, PCE was by far the most common contaminant – detected most frequently and at the highest concentrations. Further, it is an appropriate indicator of contamination attributable to dry cleaning operations. Therefore, the following discussion on the extent of groundwater contamination will be generally based on the location and concentrations of PCE on- and off-site. Table 1-1 presents a summary of PCE concentrations detected in shallow and deep groundwater between 2001 and 2005. Sampling locations are shown on Figures 1-4 and 1-5.

**Shallow Groundwater** – PCE concentrations from shallow groundwater samples are shown on Figure 1-4.

- PCE concentrations generally decrease in all directions away from the property, but to a lesser degree to the south.
- North of the building, concentrations of PCE in MW-11 and MW-02 had decreased in 2005 to around 25% of their 2002 values after increasing in 2003. MW-10D (sampled in 2003) and hydropunch samples SVE-2 and SVE-3 (sampled in 2001 by a previous consultant during the installation of SVE wells) all exhibited high

concentrations (55,000 parts per billion [ppb], 45,000 ppb, and 30,000 ppb, respectively). No additional data is available to indicate whether concentrations in these three locations have been reduced since MW-10D was not accessible during the 2005 Phase 3 RI sampling (paved over and used exclusively/constantly for storage by the site owner), and the SVE-2 and SVE-3 boreholes had been completed as SVE wells in the vadose zone. Even assuming a 75% reduction, current concentrations at these locations would still be high.

- A groundwater contamination plume is reasonably well delineated east of the property, as the comparison of PCE results to total chlorinated VOCs shows a greater presence of breakdown products. However, 1,1,1-trichloroethane (1,1,1-TCA) is not a breakdown product related directly to PCE. The highest concentration of 1,1,1-TCA was detected at MW-07D. Concentrations of PCE in MW-16, east of MW-07D, did not decrease between April 2003 and June 2005.
- Concentrations of PCE in monitoring wells far west of the property (MW-15, MW-21, MW-22, and MW-20) from June 2005 sampling indicated relatively low concentrations similar to those detected in April 2003 in deep groundwater.
- Concentrations of PCE in MW-03, MW-04, and MW-05 show an increase in PCE concentration as a plume with PCE concentrations above 10,000 ppb migrates to the south and southwest. Concentrations in these monitoring wells had originally decreased between October 2002 and December 2003, but significantly increased by June 2005. The concentration of PCE another hundred feet to the south in MW-14 had yet to increase by June 2005, but may increase in the future if current observed trends continue.
- Further to the south, groundwater in MW-24, MW-17, MW-18, MS-19 and MW-23 has been sampled and analyzed once. Concentrations of PCE in the wells suggest migration beyond MW-19 and MW-23, potentially up to another two hundred feet.

**Deep Groundwater** – PCE concentrations from groundwater samples taken from greater depths below the water table are shown on Figure 1-5.

- PCE was detected during 2001 sampling at parts per million (ppm) levels at a depth of 96 feet bgs in the SVE hydropunch samples located on the property.
- During the June 2005 round of sampling, PCE was not detected at depth in MW-12H and MW-13H where it had been previously detected; only breakdown products were detected.

In general, PCE concentrations decreased with depth and time in wells sampled.

## **1.6 Exposure Pathways**

A qualitative Human Health Risk Assessment was performed during the RI. Under the current land use scenario, soil gas was identified as a medium of concern because the pathway of exposure is complete for adjacent residents. Under the future use scenario, contaminated groundwater, and soil gas are media of concern for site residents, industrial/commercial workers or construction workers. Groundwater may potentially be used for potable or non-potable purposes, and the site may be subject to future construction activity. Ingestion, dermal absorption, and inhalation of VOCs detected in groundwater are the potential exposure pathways in the future, if groundwater is used at the site.

## **1.7 Indicator Parameters**

Compounds detected at the site are potentially degradable in ground water. The bulk of the contamination is present as chlorinated hydrocarbons, especially PCE. As presented in the RI Report, the predominant mechanism for the degradation of these compounds is reductive dechlorination. The likelihood of the occurrence of reductive dechlorination can be assessed using the following indicators (after the *Technical Protocol for Evaluating Natural Attenuation of Chlorinated Solvents in Ground Water*, USEPA 1998):

- **pH** - The pH of groundwater has an effect on the presence and activity of microbial populations. Generally, microorganisms that are most efficient biodegraders prefer neutral pH values (6 to 8). The range of values allowing reductive dechlorination to

occur is between 5 and 9. Values of pH in groundwater were found to be between approximately 6 and 7 (neutral). All pH values are within the range in which the biodegradation of chlorinated solvents can take place.

- **Nitrate** - Reductive dechlorination has been demonstrated to be favorable under nitrate-reducing conditions. The presence of nitrate-reducing conditions can be deduced by looking for zones in the plume where nitrate is at much lower concentrations than elsewhere in the groundwater. Nitrate concentrations in groundwater at the site are typically on the order of 10 mg/L. This is relatively elevated, and the pattern of contamination does not demonstrate a local zone of nitrate reduction. Therefore, nitrate-reducing conditions do not appear to be present.
- **Sulfate and Sulfide** - Sulfate-reducing conditions are favorable for the dechlorination pathway. As with nitrate, locally-depressed sulfate concentrations indicate zones of active sulfate reduction. Sulfide is a reduced product whose presence indicates strongly reducing conditions that promote reductive dechlorination. Sulfate concentrations are mostly on the order of 100 mg/L, while sulfide has been generally noted as “not detected”. Site results indicate that the conditions for dechlorination are not favorable.
- **Dissolved Oxygen** - Dissolved oxygen is the most favored electron acceptor in hydrocarbon biodegradation. Levels of less than 1 mg/L indicate that aerobic degradation has occurred, oxygen has been largely utilized, and a shift to anaerobic processes has taken place. Reductive dechlorination takes place under anaerobic conditions, generally when the dissolved oxygen levels are less than 0.5 mg/L. Typically, an anaerobic environment is created by the degradation of non-chlorinated compounds, such as BTEX (benzene, toluene, ethylbenzene, and xylenes). Following that, the likelihood of degradation of chlorinated hydrocarbons becomes high. Dissolved oxygen levels at the site are generally between 1 and 10 mg/L. Levels of approximately 0.5 mg/L have been detected only at two locations in perched groundwater. It appears that anaerobic conditions required to support the reductive dechlorination are not present at the site.

- **Ferrous Iron** - Iron-reducing conditions are favorable to the process of reductive dechlorination. Concentrations of ferrous iron higher than 1 mg/L suggest iron reduction is occurring, and thus oxidation/reduction (redox) conditions are suitable for reductive dechlorination. The ferrous iron distribution at the site shows concentrations that are generally in the range of “not detected” to 1 mg/L. Only one sampling point in perched water provided a higher value of approximately 3 mg/L. Therefore, the likelihood of conditions favoring reductive dechlorination is low.
- **Oxidation/Reduction Potential (ORP)** - Reductive dechlorination becomes possible at levels of less than approximately +50 mV. The likelihood of its occurrence is significant for ORP values less than -100 mV. In perched and shallow groundwater, the ORP values are approximately +100 to +400 mV, with one exception of +15 mV. Therefore, conditions supporting reductive dechlorination are not present in perched and shallow groundwater where the bulk of contamination is present.
- **Organic Carbon** - Organic carbon (TOC), either naturally occurring or anthropogenic, typically serves as the electron donor required to drive the dechlorination process. Levels above 20 mg/L are favorable. TOC levels in perched and shallow groundwater are generally on the order of 1 mg/L. In deep groundwater, monitoring points associated with the higher levels of hydrocarbons show TOC values greater than 20 mg/L. Therefore, TOC levels required for reductive dechlorination may occur in deep groundwater.
- **Chloride** - Chloride levels two times higher than background may indicate that the compound has been produced as a dechlorination byproduct. Typically, high chloride levels occur within the downgradient portion of the plume. For this site, regional background levels of chloride are not available. Virtually all wells are located within the area where chlorinated hydrocarbons have been detected. In addition, as a result of the changing direction of the hydraulic gradient, the plume does not appear to display typical upgradient and downgradient portions. Chloride levels detected at the site are variable. Differences between chloride concentrations detected in monitoring wells screened in deep groundwater are negligible; for perched and shallow groundwater they range within an order of magnitude.



However, the variability does not correspond to any pattern of total chlorinated hydrocarbon concentration or relative concentrations of different chlorinated compounds. The occurrence of the process of reductive dechlorination can not be assessed based on chloride data.

- Distribution of Chlorinated Species** - Significant degradation of chlorinated solvents is marked by a shift in the relative concentrations of various compounds. As degradation progresses, the original compound released into the environment breaks down into the daughter product, where successively more chloride atoms are removed from the compound molecule and replaced with hydrogen. In this case, PCE would be converted to trichloroethene (TCE), then to dichloroethene (DCE) and finally to vinyl chloride (VC). Vinyl chloride is difficult to dechlorinate further (requiring very strong reducing conditions), but it is readily oxidized under aerobic conditions. There is little evidence of this process occurring at the site. With a few exceptions, PCE remains the dominant compound in most of the monitoring wells. Vinyl chloride has generally not been detected; although very high concentrations of PCE resulted in unusually high detection limits for VC (up to 200 ppb). In summary, the distribution of concentrations of various chlorinated hydrocarbons does not appear to indicate that significant dechlorination is taking place.

The following table summarizes the likelihood of the occurrence of reductive dechlorination of chlorinated hydrocarbons detected in groundwater at the site based upon indicator parameters. It appears that under natural conditions, reductive dechlorination is unlikely to occur on a large scale.

<b>Indicator Parameter</b>	<b>Likelihood of reductive dechlorination</b>
pH	Yes
Nitrate	No
sulfate/sulfide	No
Dissolved oxygen	No
ferrous iron	No
oxidation/reduction potential	No
total organic carbon	No – shallow groundwater Yes – deep groundwater
Chloride	Can not be assessed
distribution of chlorinated species	No

## **2.0 DEVELOPMENT OF REMEDIAL ALTERNATIVES**

The approach of this FS is in accordance with NYSDEC's Technical and Administrative Guidance Memorandum (TAGM) 4030 *Selection of Remedial Actions at Inactive Hazardous Waste Sites*, revised May 15, 1990 (excluding requirements for alternative scoring and ranking), TAGM 4025 "*Guidelines for Remedial Investigations/Feasibility Studies*", and "*Draft DER-10 Technical Guidance for Site Investigation and Remediation*" prepared by the NYSDEC, dated December 2002. The development of remedial alternatives includes the following elements:

- Development of Remedial Action Objectives
- Development of General Response Actions
- Identification of Volumes or Areas of Media to be Addressed
- Identification of Technologies
- Assembly of Remedial Alternatives.

### **2.1 Remedial Action Objectives**

Remedial Action Objectives (RAOs) are goals for protection of human health and the environment. The remedy provided in the OU1 ROD addressed on-site soil and soil gas RAOs. For this FS, remedial technologies pertaining to off-site soil gas and the groundwater medium on- and off-site will be addressed.

The RAO for soil gas is as follows:

- Reduce, control, or eliminate, to the extent practicable, exposure of VOCs in soil gas to adjacent residents.

Groundwater is not currently used for potable purposes in the vicinity of the site. However, under the future use scenario groundwater may potentially be used; therefore, in the RI

ingestion, dermal absorption, and inhalation of VOCs have been identified as the potential exposure pathways under the future use scenario. The RAOs for groundwater are as follows:

- Reduce, control, or eliminate human contact with contaminated groundwater at the site.
- Reduce, control, or eliminate, to the extent practicable, migration of PCE and its degradation products through groundwater.
- Attain to the extent practicable, ambient groundwater quality standards.

## 2.2 **General Response Actions**

General response actions are broad response categories capable of satisfying the remedial action objectives for the site.

- **No Additional Action** – A no additional action response provides a baseline for comparison with other alternatives and includes: 1) the ongoing OU1 SVE IRM; 2) the ongoing vapor intrusion mitigation program; and 3) remediation proposed in the ROD for OU1.
- **Exposure Point Mitigation** – Remedial measures may be implemented at the point of exposure to mitigate exposure to contaminated material and provide adequate protection to human health and the environment.
- **Containment** – Containment measures are those remedial actions whose purpose is to contain and/or isolate contaminants. These measures prevent migration from, or direct human exposure to, contaminated media without treating, disturbing, or removing the contamination.
- **Treatment** – Treatment and disposal measures include technologies whose purpose is to reduce the toxicity, mobility, or volume of contaminants by directly altering, isolating, or destroying those contaminants. The two groups of treatment

technologies that may be considered are those that are above ground (ex situ) and those that are below ground (in situ).

## **2.3 Identification of Volumes or Areas of Media to be Addressed**

### **2.3.1 Soil Gas**

To date, the NYSDEC and NYSDOH determined through a program of individual structure sampling that 12 residences were eligible for installation of sub-slab depressurization systems to mitigate exposures or potential exposures to contaminated soil gas. Of these 12 residences, 8 locations had the systems installed and the other 4 refused the installations. Holes were drilled through the basement slabs and PVC pipes were threaded through the holes to a depth of less than 1 foot. The pipes were extended through to the outside of the residence and vented above the rooflines. An electrical fan is located within each piping system encased on the outside of the residence. Soil gas is therefore extracted from beneath the slab of each residence and released to the atmosphere. The systems were installed by Radon Management of North Scituate, Rhode Island.

At the present time, the structure sampling suggests that the entire area potentially impacted by soil gas intrusion has been identified. However, as the vapor intrusion sampling program is ongoing, future monitoring results may indicate the need for additional installations.

### **2.3.2 Groundwater**

Figure 1-4 identifies the plume of PCE contamination above 1,000 ppb. This portion of the plume extends over an area of approximately 700,000 ft<sup>2</sup>. Within the plume a concentrated area of PCE (above 10,000 ppb) extends over an area estimated to be 180,000 ft<sup>2</sup>. The depth of groundwater contamination is estimated at up to 30 feet bgs within the property area based on results from the SVE hydropunch samples and from well MW-10H. Groundwater contamination outside the property is estimated to be limited to the water table surface, as indicated through hydropunch sample taken at locations MW-12H and MW-13H

## **2.4 Identification of Technologies**

The following were taken into consideration during the identification of technologies.

- An operating business is located on-site within a building that covers most of the property area leaving a limited amount of available space for technologies that require large areas for implementation.
- Further, many buildings and residences are present over much of the area contained within the plumes. This will also preclude the use of certain technologies that require a large area for implementation.
- The estimated depth of groundwater contamination is from the water table (approximately 70 feet bgs) to a depth of 100 feet bgs onsite, but limited to the near-surface off-site.

In the following subsections, technologies related to General Response Actions (GRA) developed in Section 2.2 are identified and screened prior to the development of remedial alternatives.

### **2.4.1 No Additional Action for Soil Gas and/or Groundwater**

While the No Additional Action GRA for OU2 would include no additional action or groundwater treatment, the existing IRM SVE system would remain in place and continue to operate. Additionally, as part of the selected remedy in the ROD for OU1, new soil vapor extraction wells would be installed in well pairs (shallow and deep), and a new SVE treatment system with a carbon filter media would be installed for additional extraction wells which may result in some OU2 soil gas remediation as well. The ongoing vapor intrusion mitigation program would continue in residences affected by soil gas.

**Effectiveness:** The no additional action response is effective in addressing the exposure pathways affecting human health relating to the current use scenario, but not for possible future use and exposure scenarios.

**Implementability:** This combination of remedial measures has already been implemented at the site.

**Cost:** The cost of these measures is low to moderate.

**Conclusion:** This technology is already implemented.

#### **2.4.2 Exposure Point Mitigation**

Exposure point mitigation is used to mitigate exposure to contaminated media and provide protection to human health at the individual receptors. At this site, this includes installation and operation of sub-slab depressurization systems located at selected adjacent residences. By maintaining a slight vacuum below the basement slab, contaminant vapors are prevented from migrating through cracks and other openings in the basement slab and infiltrating into the indoor air.

**Effectiveness:** Sub-slab depressurization systems installed at the residences are effective in reducing and controlling exposure to contaminants within the adjacent residences (receptors).

**Implementability:** Sub-slab depressurization systems have already been implemented at individual residences impacted by soil gas.

**Cost:** The cost of individual units is relatively low.

**Conclusion:** Sub-slab depressurization systems at individual residences are selected for use for soil gas exposure mitigation.

### 2.4.3 Containment Technologies

Containment methods are used to prevent or reduce the migration of contaminants and prevent exposure to the contaminants. Groundwater containment methods applicable to the site include vertical cutoff walls, vertical barriers, and active hydraulic controls.

Vertical cutoff walls are structures that include slurry walls, grout curtains, sheet pile walls, and geomembranes installed on the downgradient edge of the plume.

**Effectiveness:** Vertical cutoff walls may be effective for groundwater containment if properly installed. They have been utilized at numerous remediation projects.

**Implementability:** Given the 70-foot depth to shallow groundwater and the areal extent of the plume and its presence beneath residential neighborhoods, vertical cutoff walls would be difficult to construct within the site area.

**Cost:** Due to the anticipated depth and areal extent required, the relative cost of vertical cutoff walls is expected to be moderate to high.

**Conclusion:** Vertical cutoff walls are not considered to be feasible at this site.

A permeable reactor barrier wall, also known as a permeable reactive barrier (PRB), is a vertical barrier installed downgradient of a contaminant plume. As contaminated groundwater flows through the wall, contaminants react with the materials inside the wall and are either broken down into innocuous products or immobilized by precipitation or sorption. The advantage of this in situ technology is that it requires no pumping. The most common type of permeable barrier wall is an iron treatment wall made up of zero-valent iron or iron-bearing minerals that reduce

chlorinated contaminants such as TCE and PCE. As the iron is oxidized, a chlorine atom is removed from the compound using electrons supplied by the oxidation of iron. The chlorinated compounds are reduced to nontoxic by-products. A PRB can be installed using trenching, directional injection, or hydraulic fracturing methods. Different treatment depths and installation costs are associated with each installation method.

**Effectiveness:** A permeable reactor barrier wall may be effective for groundwater containment if properly installed. They have been utilized at remediation projects.

**Implementability:** Given the 70-foot depth to shallow groundwater, directional injection or hydraulic fracturing methods would be required. The areal extent of the plume and its presence beneath residential neighborhoods would make a permeable reactor barrier wall difficult to construct. Given the relatively flat hydraulic gradient at the site, groundwater may not flow through the PRB without hydraulic influence using extraction and/or injection wells within a reasonable amount of time.

**Cost:** Due to the anticipated depth and installation method, and the areal extent required, the relative cost of a permeable reactor barrier wall is expected to be moderate to high.

**Conclusion:** A permeable reactor barrier wall is not considered to be feasible at this site.

Active hydraulic control methods include wells and/or collection trenches that are used for the injection and/or extraction of fluids.

**Effectiveness:** A groundwater collection trench may be effective for groundwater containment if properly installed. They have been utilized at numerous remediation projects.

**Implementability:** Given the 70-foot depth to shallow groundwater and the areal extent of the plume and its presence beneath residential neighborhoods, a groundwater collection trench would be difficult to construct within the site area.



**Cost:** Due to the anticipated depth and areal extent required, the relative cost of a groundwater collection trench is expected to be moderate to high.

**Conclusion:** A groundwater collection trench is not considered to be feasible at this site.

Vertical injection wells are considered feasible for use at this site since they can be individually located to any depth around existing structures.

**Effectiveness:** Given the relatively flat hydraulic gradient at the site, injection wells injecting clean water could be added to the groundwater system to create a positive gradient towards downgradient extraction wells. At this site, contaminant migration within shallow groundwater appears to be towards the south and southwest. Water injection could cause additional migration of contaminants into areas beyond the current migration patterns both radially and downward. For this reason, injection of clean water alone into the subsurface may not be effective. Injection of water amended with nutrients and/or chemicals will be considered under in situ treatment technologies.

**Implementability:** Installation of injection wells around existing residences would be implementable.

**Cost:** The relative cost of injection wells, which could be individually located to any depth around any existing structures, is low to moderate depending on the number and flow rate required.

**Conclusion:** Injection of clean water to the subsurface may promote additional migration of contaminants into areas beyond current migration patterns, therefore injection of clean water alone will not be considered further. Injection of water amended with nutrients and/or chemicals will be considered for use with in situ treatment technologies.

Groundwater could be extracted within and/or along the downgradient edge of the plume(s) through extraction wells individually located to any depth around existing structures.

Contaminated groundwater captured from within the plume would be subject to treatment as discussed in Section 2.3.5.

**Effectiveness:** Extraction wells could be located to control the contaminant migration in groundwater, as well as to extract groundwater for treatment. They have been utilized at numerous remediation projects. When combined with appropriate treatment, groundwater extraction would be effective at the site.

**Implementability:** Installation of extraction wells around existing residences would be implementable.

**Cost:** The relative cost of extraction wells, which could be individually located to any depth around any existing structures, is low to moderate depending on the number and flow rates required.

**Conclusion:** Extraction wells are considered feasible for use at the site.

#### **2.4.4 Treatment Technologies**

Treatment technologies may be used to reduce the toxicity of contaminants present at the site. Treatment technologies pertaining to contaminated extracted groundwater include pumping to either an above-ground treatment facility constructed specifically for use at this site, or an existing facility willing and capable to accept collected water. Groundwater could also be treated within an in-well treatment system and re-injected to the subsurface, or in-situ (i.e., in place without extraction) utilizing a number of chemical, biological, and/or physical processes.

##### **2.4.4.1 Constructed Treatment System for Extracted Groundwater**

An above-ground site-specific groundwater treatment system could be designed to accommodate the levels of contaminants and flow rates anticipated from groundwater extracted at

the site. The treatment facility is anticipated to minimally include: an extraction system (consisting of one or more extraction wells and submersible pumps), an air stripper for the removal of VOCs, and vapor phase carbon units to remove contaminants in the off-gas from the air stripper. Other potential components could include:

- An influent equalization tank in the event that multiple extraction pumps are utilized.
- A chemical feed system to prevent scaling of the air stripper and/or pH adjustment of the effluent water.
- Treatment of MTBE (detected in MW-24D within the concentrated plume area) requiring a larger air stripper and air flow than for any of the other contaminants detected. This would also raise the operation and maintenance cost due to the additional airflow.
- Conveyance of treated water through a force main to the local sewer system.

**Effectiveness:** A properly designed treatment system could effectively treat collected groundwater. Treatment would have to meet the rigorous and appropriate levels for subsequent discharge to the local sewer system. The air stripper would have to meet air emissions requirements.

**Implementability:** A treatment system would require a secure location for the air stripper and tanks, etc., preferably on the Kliegman Bros. property, and should consider the location of the nearest sewer. It is anticipated that while this may be logistically possible, it may not be implementable. The proximity to residences may require that the air discharge be through a tall stack that may visually impact the residents.

**Cost:** Relative costs are assumed to be moderate to high considering the quantity of groundwater expected, the fact that treatment of water and air will have to meet appropriate standards, and the unknowns associated with the need for the above-mentioned additional components.

**Conclusion:** An above-ground treatment facility designed and constructed for treatment of extracted groundwater will be retained.

#### **2.4.4.2 Off-site Treatment of Extracted Groundwater**

Extracted groundwater could be conveyed by direct discharge line, or tanker, to an appropriate water treatment facility capable and willing to accept the levels of contamination and volume of water without treatment.

**Effectiveness:** An appropriate off-site treatment system could effectively treat collected groundwater.

**Implementability:** Given the estimated flow rates and levels of contamination, it is expected that it may be difficult to locate an appropriate treatment facility capable and willing to accept collected water. Transporting such large quantities within tanker trucks would not be feasible through the residential neighborhoods.

**Cost:** The relative costs are assumed to be high considering the quantity of groundwater and levels of contamination expected.

**Conclusion:** Off-site treatment of extracted groundwater will not be retained since implementation would be difficult and the relative cost is anticipated to be high.

#### **2.4.4.3 In-well Treatment System**

With an in-well treatment system, as groundwater is pumped through the extraction well, it passes through a reactor located within the extraction well. Within the reactor, a catalytic reductive dehalogenation process takes place. A reducing agent, such as dissolved hydrogen, in the presence of a palladium-on-alumina catalyst chemically would transform PCE into benign ethane without the accumulation of intermediate transformation product such as vinyl chloride.

The reactor can be placed in a dual-screened well, allowing contaminated groundwater to be drawn from one zone, treated within the well, and discharged to another zone. This technology is potentially feasible for use at the site; however, it has yet to be demonstrated as effective on a large-scale project and for use with large flow rates.

**Effectiveness:** This technology has been found to be effective in treating PCE in groundwater. An appropriate in-well treatment system utilizing multiple extraction wells could be designed for use within multiple extraction wells (to lower individual extraction rates) at the site to effectively treat groundwater.

**Implementability:** This technology has yet to be demonstrated as effective on a large-scale project or for use at sites with flow rates above 3 gallons per minute (gpm). The installation of multiple extraction wells within the residential area of the site may not be feasible.

**Cost:** The relative costs are assumed to be moderate considering the need for multiple extraction wells and the quantity of groundwater expected.

**Conclusion:** An in-well treatment system will not be retained since implementation would be difficult and the technology has not been proven on a project of this scale.

#### **2.4.4.4 In Situ Biological Treatment**

The majority of contamination at the site is present as chlorinated hydrocarbons. The predominant mechanism for the degradation of these compounds is reductive dechlorination. A review of the levels of indicator parameters presented in Section 1.5.4 indicates that existing conditions are not necessarily favorable towards reductive dechlorination of the chlorinated compounds present in groundwater at the site. As part of an in situ biological treatment system, amendments such as nutrients, electron donors, and microorganisms could be introduced into the groundwater system through injection wells in order to stimulate the existing or added microorganisms to grow and destroy the contaminants. Microorganisms (e.g., *Dehalococcoides*

*ethenogenes* [DHC]) have been shown to effectively break down PCE, relying on hydrogen to power their metabolic needs, producing the non-toxic byproduct ethene.

**Effectiveness:** Given that naturally occurring conditions have been determined to not necessarily be favorable towards reductive dechlorination at this site, microorganisms and electron donors, along with necessary nutrients would have to be added to the groundwater to stimulate anaerobic degradation. The effectiveness of in situ biological treatment on the relatively high levels of PCE is considered somewhat innovative and has not been rigorously field tested.

**Implementability:** Injection of microorganisms and electron donors within the contaminant plume through a series of injection wells would be implementable. Proximity to residences located within the target treatment area must be considered in the location of injection wells and the type of mixing and injection system (e.g., stationary or mobile) to be implemented. Injection of bioamendments alone, or in addition to, an extraction system (e.g., recirculation system) could be used for treatment, potentially providing a more focused treatment area and/or additional hydraulic control.

**Cost:** The relative cost is anticipated to be moderate to high as an injection well system would have to be constructed along with the materials and facilities required for biological treatment of PCE levels present in groundwater at the site.

**Conclusion:** In situ biological treatment will not be further considered due to its unknown effectiveness and anticipated high relative cost for existing concentrations present at the site.

#### **2.4.5 In Situ Chemical Oxidation Treatment**

Groundwater treatment using in situ chemical oxidation (ISCO) is the delivery of chemical oxidant to contaminated media to destroy target contaminants and convert them to innocuous compounds. ISCO is effective both within a contaminant source area as well as a

dissolved phase plume area. The rate and extent of degradation of chlorinated organics using chemical oxidation are dictated by the properties of the contaminant(s) and their susceptibility to oxidation. In addition, soil and groundwater matrix conditions (e.g., pH, temperature), and the concentration of other oxidant-consuming substances, such as natural organic matter and reduced minerals – the natural or soil oxidant demand (NOD/SOD) – affect the transport and reactions of both the oxidant and the target contaminant(s). Chemical oxidation is an aqueous reaction and therefore, reactions will only occur with dissolved phase contaminant mass. Residual and/or sorbed phase contaminant mass will transfer to the dissolved phase as delivered oxidants react with existing dissolved phase contamination. ISCO relies upon contact between oxidant and target contaminants with adequate residence time for complete oxidation of dissolved and sorbed phase contaminant mass. Thus, a primary design component of an ISCO application is achieving adequate subsurface distribution.

Typical chemical oxidants used for environmental remediation include Fenton's reagent, permanganate ( $\text{MnO}_4^-$ ), ozone ( $\text{O}_3$ ), and persulfate ( $\text{S}_2\text{O}_8^{2-}$ ). Oxidants are typically added to the subsurface through a series of temporary or permanent injection wells. Considering the depth to groundwater at this site, permanent injection wells may be required. Additionally, given the space limitations at this site, a mobile mixing and delivery system, versus a permanent injection system, may be required. Groundwater treatment using ISCO does not require groundwater extraction, but could be paired with an extraction system for additional contaminant removal, hydraulic control, or to induce a more pronounced hydraulic gradient.

For all chemical oxidants, bench-scale and/or field-scale pilot testing is recommended. Bench-scale pilot testing may include an analysis of the soil buffering capacity and/or the potential for metals leaching. During the application of ISCO materials, secondary effects to the aquifer such as a change in the oxidation-reduction potential or pH can contribute to a localized mobilization of metals (e.g., manganese, chromium, arsenic, selenium, and/or lead). Typically, due to the natural soil buffering capacity (e.g., ability of the aquifer to re-establish neutral conditions), these effects are transitory and very localized within the target treatment area. As influent groundwater enters, or treated groundwater leaves the treatment zone, metals will re-precipitate upon contact with neutral (or native) groundwater conditions. Any bench-scale testing will be compared to NOD/SOD analyses previously conducted for the site.

Four types of chemical oxidants, Fenton's reagent, permanganate, ozone, and persulfate used for environmental remediation are evaluated below.

### **Fenton's Reagent**

Conventional Fenton's chemistry reactions are produced when hydrogen peroxide (H<sub>2</sub>O<sub>2</sub>) is applied with an iron catalyst (Fe<sup>2+</sup>), creating a hydroxyl free radical (<sup>•</sup>OH) capable of oxidizing complex organic compounds including petroleum-related compounds (e.g., BTEX, MTBE) and chlorinated alkenes (e.g., PCE, TCE, DCE, and VC). The creation of the hydroxyl free radical (<sup>•</sup>OH) through Fenton's chemistry is shown in Equation 1 where H<sub>2</sub>O<sub>2</sub> is hydrogen peroxide, Fe<sup>2+</sup> is ferrous iron (i.e., the catalyst), <sup>•</sup>OH is the hydroxyl free radical, OH<sup>-</sup> is an hydroxide ion, and Fe<sup>3+</sup> is ferric iron.

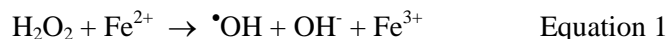

Residual hydrogen peroxide (H<sub>2</sub>O<sub>2</sub>) decomposes into water and oxygen in the subsurface and any remaining iron precipitates out of groundwater as ferric iron (Fe<sup>3+</sup>). In addition, the hydroxyl radical (<sup>•</sup>OH) reacts with natural organic material to form carbon dioxide and chloride.

There are two forms of Fenton's reagent applied in environmental remediation: traditional Fenton's reagent requires a step to acidify the aquifer (e.g., pH 3 to 6) and uses higher concentrations of liquid hydrogen peroxide (e.g., approximately 30%); and modified Fenton's reagent, which can be used under neutral groundwater conditions and uses a lower concentration of hydrogen peroxide (e.g., approximately 4% to 17%). For modified Fenton's applications, the use of a lower concentration of hydrogen peroxide minimizes heat generation and reduces the production of oxygen gas generated during the reaction. Modified Fenton's reagent formulas incorporate both liquid and solid peroxides. The use of solid peroxides has the potential to increase the longevity for oxidation from approximately one to three days with liquid peroxide to three to four weeks with solid peroxide.



**Effectiveness:** ISCO using traditional and modified Fenton's reagents has been proven effective for remediation of chlorinated and petroleum-related compounds in groundwater. The pH in the aquifer at the site was found to be between 6 and 7 (neutral). Traditional Fenton's reagent would require acidification of the aquifer prior to implementation. Modified Fenton's reagent would not require pH adjustment prior to implementation for effective treatment.

**Implementability:** Implementation of ISCO involves two components: introduction of adequate volumes of oxidant and subsurface distribution or target area coverage. Considering the lithology present at the site, traditional Fenton's might be implementable; however, the off-gassing associated with the traditional Fenton's reaction might prevent the injection of required oxidant quantities. Due to the reduced to no off-gassing associated with modified Fenton's reagent using liquid or solid peroxides, implementation via an injection well system would allow for adequate oxidant injection per location.

Proximity to residences located within the target treatment area must be considered in the location of injection wells and the type of mixing and injection system (e.g., stationary or mobile) to be implemented. Due to space limitations (e.g., highly developed neighborhood) at the site, implementation of any in situ remediation system would be difficult in terms of accessing the target treatment area via injection wells. Injection of chemical oxidants alone, or in addition to, an extraction system (e.g., recirculation system) could be used for treatment, potentially providing a more focused treatment area and/or additional hydraulic control.

**Cost:** The relative costs of all ISCO processes are assumed to be moderate. The costs associated with the modified Fenton's reagent (e.g., the combination of chelated iron and liquid peroxide, or specific formulas of chelated iron and solid peroxides) may require licensing or patent fees that would increase the overall cost of materials relative to other oxidants.

**Conclusion:** ISCO using modified Fenton's reagent (i.e., using liquid and solid peroxide based reagents) will be retained.

### Permanganate

Permanganate is a common oxidant introduced to react with and oxidize organic compounds. Delivered either as potassium permanganate (KMnO<sub>4</sub>) or sodium permanganate salts (NaMnO<sub>4</sub>), KMnO<sub>4</sub> comes in a granular form that is then mixed with water in a low solubility (i.e., 2% to 4%) solution, and NaMnO<sub>4</sub> comes as a strongly oxidizing liquid (e.g., 40% solution). Permanganate destroys contaminants through an ionic reaction, versus the hydroxyl radical production described for Fenton's reagent. There is no gas production associated with the permanganate reaction, and therefore it can be easier to implement. Permanganate also has a longer reaction time, and therefore has the potential to be more persistent within the subsurface. However, in terms of oxidative strength, permanganate is a weaker oxidant as compared to other oxidants that create free radicals (e.g., Fenton's reagent, activated persulfate, and ozone). Permanganate has been widely used and can be used as a polishing step, introduced following more aggressive treatment using another oxidant, such as Fenton's reagent, etc.

The primary oxidation reaction for the permanganate ion over a pH range of 3 to 12 is shown in Equation 2, where MnO<sub>4</sub><sup>-</sup> is the permanganate ion, H<sub>2</sub>O is water, e<sup>-</sup> is an electron, MnO<sub>2(s)</sub> is manganese dioxide solid, and OH<sup>-</sup> is the hydroxyl ion.

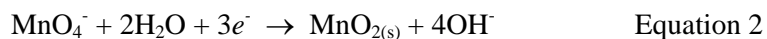

As shown in Equation 2, solid manganese dioxide (MnO<sub>2</sub>) is a precipitate byproduct of permanganate oxidation. MnO<sub>2</sub> has a brown, rusty color that can form small colloids. Although there was early concern over aquifer permeability loss due to MnO<sub>2</sub> precipitation, by incorporating more site-specific data into the project design and implementation, precipitate production can be limited to discrete, micron-sized particles that are able to remain mobile in groundwater. Site-specific data may include NOD, naturally occurring minerals, concentrations of contaminants indicating the presence of a pooled dense non-aqueous phase liquid (DNAPL),

and/or oxidant quantities required for complete treatment. Bench-scale pilot testing may be required to determine the existing NOD at this site.

Permanganate has demonstrated significant effectiveness in attacking and breaking the carbon-carbon bonds in chlorinated solvents such as PCE, TCE, DCE and VC. However, permanganate is not effective at treating petroleum-related compounds such as MTBE. In comparison to the other chemical oxidants available, permanganate is very persistent, and therefore can travel downgradient with groundwater from the point of injection. The longevity of permanganate, however, is directly associated with the oxidizable materials present within the subsurface, both naturally occurring compounds and contaminant mass.

**Effectiveness:** Permanganate is widely used and has been found to be a rapid and effective treatment for organics. Reactions are most effective in systems with a pH between 3 and 10. The pH in the aquifer at the site was found to be between 6 and 7 (neutral). Permanganate is relatively more stable (i.e., no off-gassing) than other ISCO processes and can be relatively more persistent in the subsurface.

**Implementability:** Implementation of ISCO involves two components: introduction of adequate volumes of oxidant and subsurface distribution or target area coverage. Considering the lithology present, ISCO implementation via an injection well system would allow for adequate permanganate injection per location. In terms of health and safety, the  $\text{NaMnO}_4$  liquid form requires very strict handling requirements and therefore may not be suitable for use within a residential setting.

Proximity to residences located within the target treatment area must be considered in the location of injection wells and the type of mixing and injection system (e.g., stationary or mobile) to be implemented. Due to space limitations (e.g., highly developed neighborhood) at the site, implementation of any in situ remediation system would be difficult in terms of accessing the target treatment area via injection wells. Injection of chemical oxidants alone, or in addition to, an extraction system (e.g., recirculation

system) could be used for treatment, potentially providing a more focused treatment area and/or additional hydraulic control.

**Cost:** The relative costs of all ISCO processes are assumed to be moderate. The costs associated with the  $\text{NaMnO}_4$  are relatively higher than for  $\text{KMnO}_4$ . In general, the per pound cost of permanganate is lower compared to other oxidants; however due to the nature of the permanganate oxidation reaction, significantly greater quantities of permanganate may be required to equal the strength of other oxidants.

**Conclusion:** ISCO utilizing permanganate will be retained.

### Ozone

Ozone gas ( $\text{O}_3$ ) is a strong oxidant capable of destroying petroleum and chlorinated hydrocarbons contaminants directly or through the formation of hydroxyl radicals. The ozone direct oxidation and hydroxyl formation reactions are shown below in Equations 3 and 4, where  $\text{O}_3$  is ozone,  $\text{H}^+$  is a proton,  $e^-$  is an electron,  $\text{H}_2\text{O}$  is water,  $\text{O}_2$  is oxygen gas, and  $\cdot\text{OH}$  is the hydroxyl radical.

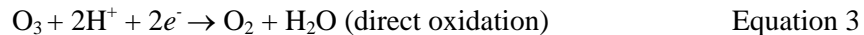

The oxidation potential from direct oxidation by ozone is lower than the hydroxyl radical ( $\cdot\text{OH}$ ) from Fenton's reagent. Ozone is typically generated electrically on site and is immediately delivered to the subsurface through wells, eliminating the need for oxidant storage and handling. Treatment with ozone generally requires that the gas be generated in close proximity to the treatment area, and that wells are closely spaced. Ozone has a half-life of several hours in air at low concentration, and several minutes in water, however, the reaction rate of ozone is typically much faster than its decomposition rate.

**Effectiveness:** ISCO using ozone has been proven to be effective in lowering the toxicity and volume of chlorinated compounds in groundwater.

**Implementability:** Implementation of ISCO involves two components: introduction of adequate volumes of oxidant and subsurface distribution or target area coverage. Considering the lithology present, ISCO implementation via an injection well system would allow for adequate ozone injection per location. In addition, due to ozone's high reactivity and instability, ozone must be produced on site, and would require more closely spaced delivery points (i.e., injection wells) compared to other oxidants. The target depth range for oxidant injection at this site would require high-pressure compressors to inject the ozone.

Proximity to residences located within the target treatment area must be considered in the location of injection wells and the type of mixing and injection system (e.g., stationary or mobile) to be implemented. Typically, ozone injection systems are stationary, which would require a secure location to stage ozone generation and compressor equipment with below grade piping to nearby injection wells.

Due to space limitations (e.g., highly developed neighborhood) at the site, implementation of any in situ remediation system would be difficult in terms of accessing the target treatment area via injection wells. Injection of chemical oxidants alone, or in addition to, an extraction system (e.g., recirculation system) could be used for treatment, potentially providing a more focused treatment area and/or additional hydraulic control.

**Cost:** The relative costs of all ISCO processes are assumed to be moderate. Ozone will require more closely-spaced delivery points than other ISCO processes and may require onsite staging of ozone generation and injection equipment; therefore the relative cost compared to other ISCO processes may be higher over the length of the remedial action.

**Conclusion:** ISCO utilizing ozone will not be retained.

## Persulfate

Injection of persulfate solution for environmental remediation is an emerging technology for in situ oxidation of a wide range of organic compounds. Laboratory testing and limited field testing have shown that persulfate can oxidize a wide range of environmental contaminants including PCE, TCE and petroleum-related compounds, though the field application of activated persulfate does not yet appear to have been optimized. Persulfate has a very strong oxidation potential similar to that of modified Fenton's chemistry, but has the potential to be very persistent similar to permanganate.

Persulfate salts are water-soluble, crystalline solids that, when catalyzed, react to form persulfate radicals ( $\text{SO}_4^{\cdot-}$ ). These radicals are strong oxidants that may react with contaminants as well as non-target compounds such as natural organic matter and other soil species susceptible to oxidation (e.g., NOD). The end product is sulfate, as shown below in Equations 5 and 6; the electron,  $e^-$ , in Equation 6 is a result of the oxidized contaminant.



Activation of persulfate may be accomplished with either heat or a transition metal-based catalyst, such as iron. An iron catalyst can be added with the persulfate solution, although it is possible that background transition metal concentrations could be sufficient for effective oxidation. Persulfate is effective at near-neutral pH, so acidification of the treatment solution or the aquifer is not necessary. In addition, there is no significant heat or off-gassing generated during the oxidation reaction with chlorinated organics.

**Effectiveness:** Activated persulfate is a very recently used oxidant for environmental purposes, although in laboratory studies it has been found to be a rapid and effective treatment for chlorinated organics including PCE. Activated persulfate has the potential as a strong oxidant as well as being relatively persistent within the subsurface. However, given the recent entrance of persulfate into the remediation market (i.e., less than five

years ago) it's application is considered somewhat innovative and has not been rigorously field tested. Alternative techniques for adequately activating persulfate in situ (i.e., liquid or solid peroxides, heat and/or chelated iron catalysis) may be required to refine ISCO using activated persulfate.

**Implementability:** Implementation of ISCO involves two components: introduction of adequate volumes of oxidant and subsurface distribution or target area coverage. Considering the lithology present, ISCO implementation via an injection well system would allow for adequate persulfate injection per location.

Proximity to residences located within the target treatment area must be considered in the location of injection wells and the type of mixing and injection system (e.g., stationary or mobile) to be implemented. Due to space limitations (e.g., highly developed neighborhood) at the site, implementation of any in situ remediation system would be difficult in terms of accessing the target treatment area via injection wells. Injection of chemical oxidants alone, or in addition to, an extraction system (e.g., recirculation system) could be used for treatment, potentially providing a more focused treatment area and/or additional hydraulic control.

**Cost:** The relative costs of all ISCO processes are assumed to be moderate. The costs associated with the activated persulfate (e.g., the combination of persulfate and chelated iron or liquid peroxide) may require licensing or patent fees that would increase the overall cost of materials relative to other oxidants.

**Conclusion:** Although activated persulfate may be effective on PCE, for the purposed of this FS, it will not be retained as modified Fenton's reagent and permanganate appear to be more established technologies.

#### **2.4.6 In Situ Physical/Thermal Treatment**

In situ physical/thermal treatment technologies potentially applicable for this site include air sparging and steam injection. Air sparging is the process of injecting air directly into groundwater to a depth below the desired depth of remediation. Air sparging remediates groundwater by volatilizing contaminants and enhancing biodegradation. As the air bubbles through the groundwater, contaminants are removed from the groundwater by physical contact with the air (i.e., stripping) and are carried up into the vadose zone. Air sparging must then be combined with an SVE system to remove vapors from the vadose zone.

Less mobile contaminants such as semi-volatiles would require the addition of heat to air sparging necessitating steam and/or hot water injection. While VOCs also can be treated by this technology, air sparging alone would be the more cost-effective process for this site.

**Effectiveness:** Air sparging may be effective in volatilizing VOCs from groundwater to the vadose zone. However, an extensive SVE system would have to be implemented to collect and treat vapors migrating to the vadose zone.

**Implementability:** Air sparging and SVE systems could be implemented to capture migrating contaminants through a series of injection and extraction wells within the plume area. However, given the space limitations for well installations across the site, this would be difficult. Additionally, there is concern for operating technologies that mobilize contaminants to the vapor phase when there are residences located above the treatment area as exposure through vapor intrusion could be increased.

**Cost:** The relative cost of installing and operating injection and extraction wells along with their treatment systems is expected to be high.

**Conclusion:** In situ physical/thermal treatment will not be retained.



## **2.5 Development of Alternatives**

### **2.5.1 Alternative 1 – No Additional Action**

The No Additional Action alternative was established by the National Contingency Plan and is used as a baseline to evaluate other alternatives. This alternative is included to fulfill the procedural requirements of 6NYCRR Part 375. Under this alternative, the existing IRM would remain in-place and continue to operate. In addition, individual sub-slab depressurization systems have been installed at 8 of the 12 residences identified by the NYSDEC and NYSDOH as currently or potentially exposed to contaminated soil vapor. The systems collect soil gasses from beneath the residences and vent them to the atmosphere. The ongoing vapor intrusion mitigation program will continue to monitor soil gas levels at adjacent residences and assess the need for additional system sub-slab depressurization installations. Additional system installations will be conducted as necessary in the future to provide mitigation. For the purposes of the FS, it is assumed that three such installations would be performed each year following indoor air sampling during the heating season.

A ROD has been issued for OU1 by NYSDEC. The No Additional Action alternative considers that the provisions of that ROD will be implemented creating a new baseline for the site. New components would be added to the remediation including the following and operate until the remedial objectives for OU1 have been achieved, or until the NYSDEC determines that continued operation is technically impracticable.

1. Six new vapor extraction wells will be installed in the northern yard (parking lot) north of the existing building. A shallow and deep well pair will be installed at two of the three locations. Well/well pairs will be spaced about 80 feet apart based on an 80-foot radius of influence determined during the IRM. This spacing and radius of influence provides coverage for the entire OU1 area.
2. A new SVE treatment system will be installed for the additional extraction wells. The new SVE system will be designed to handle about 2.5 times the amount of

extracted soil gas as the current IRM. The system will include a moisture separator, two blowers at approximately 260 scfm each, and two 1,000-pound carbon vessels. Extraction wells will be connected to the SVE system by underground pipe.

3. Monitoring of the extracted soil vapor will continue to confirm the effectiveness of the remedy.
4. Yearly installation of three sub-slab depressurization systems.

### **2.5.2 Alternative 2A – Groundwater Extraction from Concentrated Plume Area with Above-Ground Water Treatment**

Alternative 2A is a groundwater extraction and treatment alternative that addresses the most contaminated portion of the plume. Alternative 2A would include all components of Alternative 1 and additionally include a groundwater extraction well in the concentrated plume area (PCE concentrations >10,000 ppb) with subsequent above-ground water treatment. Calculations presented in Appendix A document the process followed to determine the optimal location of a single extraction well. A single extraction well is preferred due to the lack of open space for well location, the presence of numerous existing subsurface utilities, and the fact that additional equipment may be required for the treatment facility given multiple wells. Based on the evaluation of a variety of configurations as documented in Appendix A, the lowest extraction rate that would be effective in containing the 10,000 ppb plume is 150 gpm with one well, located approximately 100 feet from the southern limit of the 10,000 ppb area in the vicinity of existing monitoring well MW-24D. Components of this alternative are:

1. Installation of a single groundwater extraction well withdrawing 150 gpm from the water table groundwater located within the concentrated plume area.
2. Construction of a treatment system utilizing the treatment process shown on Figure 2-1 to treat extracted groundwater. The treatment system is anticipated to minimally include: an air stripper for the removal of VOCs and vapor phase carbon units to remove contaminants in off-gas from the air stripper. As mentioned in Section

2.4.4.1, other potential components could include: chemical feed system to prevent scaling of the air stripper, pH adjustment of the effluent water which may be increased by the air stripper, additional treatment for MTBE if the air stripper is not capable of treating to the discharge limitations, and an acid scrubber to remove HCl from the oxidizer discharge.

3. Conveyance of treated water to the local sewer system.
4. Operation and maintenance of the well and treatment system.

The ongoing vapor intrusion mitigation program will continue to monitor soil gas levels at adjacent residences and assess the need for additional system sub-slab depressurization installations. Additional system installations will be conducted as necessary in the future to provide mitigation. For the purposes of the FS, it is assumed that three such installations would be performed each year following indoor air sampling during the heating season.

### **2.5.3 Alternative 2B – Groundwater Extraction from Expanded Plume Area with Above-Ground Water Treatment**

Alternative 2B is a groundwater extraction and treatment alternative that addresses an expanded area of the groundwater plume. Alternative 2B would include all components of Alternative 1 and additionally include groundwater extraction from the plume area characterized by PCE concentrations greater than 1,000 ppb with subsequent above-ground water treatment. Calculations presented in Appendix A document the process followed to determine the optimal location of extraction wells. A minimum number of extraction wells is preferred due to the lack of open space for well locations, the presence of numerous existing subsurface utilities, and the fact that additional equipment (e.g., equalization tanks) may be required for the treatment facility given multiple wells. Based on the evaluation of a variety of configurations as documented in Appendix A, the lowest extraction rate that would be effective in containing the 1,000 ppb plume is 300 gpm with two wells located near the downgradient edge. Components of this alternative are:

1. Installation of two groundwater extraction wells withdrawing 300 gpm from the water table groundwater located within the plume area.
2. Construction of a treatment system utilizing the treatment process shown on Figure 2-1 to treat extracted groundwater. The treatment system is anticipated to minimally include: an air stripper for the removal of VOCs and vapor phase carbon units to remove contaminants in off-gas from the air stripper. As mentioned in Section 2.4.4.1, other potential components could include: chemical feed system to prevent scaling of the air stripper, pH adjustment of the effluent water which may be increased by the air stripper, and additional treatment for MTBE if the air stripper is not capable of treating to the discharge limitations.
3. Conveyance of treated water to the local sewer system.
4. Operation and maintenance of the wells and treatment system.
5. The ongoing vapor intrusion mitigation program will continue to monitor soil gas levels at adjacent residences and assess the need for additional system sub-slab depressurization installations. Additional system installations will be conducted as necessary in the future to provide mitigation. For the purposes of the FS, it is assumed that three such installations would be performed each year following indoor air sampling during the heating season.

#### **2.5.4 Alternative 3A – In Situ Chemical Oxidation Treatment of Concentrated Plume Area**

Alternative 3A is an ISCO alternative that addresses the source area (i.e., groundwater associated with OU1) and the most contaminated portion of the plume (i.e., within the 10 ppm [10,000 ppb] PCE concentration contour extending downgradient from the OU1 boundary). Alternative 3A would include all components of Alternative 1 and additionally include injection of chemical oxidants (modified Fenton's reagent and/or permanganate) into the groundwater to oxidize organic contaminants (e.g., PCE) to non-toxic compounds. Components of this alternative are:

1. Focused injection of chemical oxidants to reduce contaminant mass within the source area (roughly, groundwater associated with OU1) and concentrated plume area. (i.e., within the 10 ppm [10,000 ppb] contour extending downgradient from the OU1 boundary). Injection locations will be selected to best support subsurface distribution and therefore, surface contact between the chemical oxidant and the dissolved phase contaminant mass. A field-scale pilot test would be performed as part of the remedial design prior to remedy implementation to estimate oxidant quantities, injection flow rates, and subsurface distribution parameters. For the purposes of the FS, it is assumed that three ISCO applications utilizing modified Fenton's reagent followed by one ISCO application utilizing permanganate will be required for initial treatment. The initial three injections would provide the highest oxidation power to achieve the greatest initial contaminant destruction and to partially desorb PCE. The final injection of permanganate would provide longer-lasting continuing oxidation to treat zones of contamination not directly contacted with the initial three injections of Fenton's reagent
2. Monitoring of the PCE concentrations throughout the extent of the treatment area.
3. Based upon ISCO applications and performance monitoring, additional ISCO applications may be required to continue treatment of contaminant mass within the saturated zone. As dissolved phase contaminant mass is treated, sorbed and/or residual phase contaminant mass will desorb into the dissolved phase, and therefore may require additional oxidant mass for subsequent treatment. The need for additional ISCO applications will be evaluated based on ongoing performance groundwater monitoring. For the purposes of the FS, it is assumed that two additional permanganate injection events may be required for additional polishing, or finishing treatment.
4. The ongoing vapor intrusion mitigation program will continue to monitor soil gas levels at adjacent residences and assess the need for additional system sub-slab depressurization installations. Additional system installations will be conducted as necessary in the future to provide mitigation. For the purposes of the FS, it is assumed that three such installations would be performed each year following indoor air sampling during the heating season.

### **2.5.5 Alternative 3B – In Situ Chemical Oxidation Treatment of Expanded Plume Area**

Alternative 3B is an ISCO alternative that addresses the source area and the groundwater plume downgradient of the source. Alternative 3B would include all components of Alternative 1 and additionally include injection of chemical oxidants (modified Fenton's reagent and/or permanganate) into the groundwater within a larger portion of the plume (i.e., within the 1 ppm [1,000 ppb] PCE concentration contour) to oxidize organic contaminants (e.g., PCE) to non-toxic compounds, therefore target treatment over the expanded plume area. Components of this alternative are:

1. Focused injection of chemical oxidants to reduce contaminant mass in the source area (i.e., groundwater associated with OU1), the concentrated plume area (i.e., within the 10 ppm [10,000 ppb] contour extending downgradient from the OU1 boundary), and additionally within the expanded plume (i.e., within the 1 ppm [1,000 ppb] PCE concentration contour). Injection locations will be selected to best support subsurface distribution and therefore, surface contact between the chemical oxidant and the dissolved phase contaminant mass. A field-scale pilot test would be performed as part of the remedial design prior to remedy implementation to estimate oxidant quantities, injection flow rates, and subsurface distribution parameters. For the purposes of the FS, it is assumed that three ISCO applications utilizing modified Fenton's reagent followed by one ISCO application utilizing permanganate will be required for initial treatment. The initial three injections would provide the highest oxidation power to achieve the greatest initial contaminant destruction and to partially desorb PCE. The final injection of permanganate would provide longer-lasting continuing oxidation to treat zones of contamination not directly contacted with the initial three injections of Fenton's reagent
2. Monitoring of the PCE concentrations throughout the extent of the treatment area.
3. Based upon ISCO applications and performance monitoring, additional ISCO applications may be required to continue treatment of contaminant mass within the saturated zone. As dissolved phase contaminant mass is treated, sorbed and/or residual phase contaminant mass will desorb into the dissolved phase, and therefore

may require additional oxidant mass for subsequent treatment. The need for additional ISCO applications will be evaluated based on ongoing performance groundwater monitoring. For the purposes of the FS, it is assumed that two additional permanganate injection events may be required for additional polishing, or finishing treatment.

4. The ongoing vapor intrusion mitigation program will continue to monitor soil gas levels at adjacent residences and assess the need for additional system sub-slab depressurization installations. Additional system installations will be conducted as necessary in the future to provide mitigation. For the purposes of the FS, it is assumed that three such installations would be performed each year following indoor air sampling during the heating season.

#### **2.5.6 Alternative 4 - In Situ Chemical Oxidation Treatment of Concentrated Plume Area with Induced Groundwater Gradient**

Alternative 4 would include all components of Alternative 1 and additionally combines a similar ISCO approach as presented in Alternative 3A but coupled with a groundwater extraction well to induce a gradient within the saturated zone. This alternative includes injection of chemical oxidants (modified Fenton's reagent and/or permanganate) at the source area (i.e., groundwater associated with OU1) and a portion of the most contaminated portion of the plume (i.e., a portion of the area within the 10 ppm [10,000 ppb] PCE concentration contour extending downgradient from the OU1 boundary) into the groundwater to oxidize organic contaminants (e.g., PCE) to non-toxic compounds. In addition to the ISCO component, Alternative 4 incorporates an extraction well to generate a groundwater gradient that would promote migration of the injected reagent over a larger portion of the plume, including beneath existing structures where access for injection may not be feasible. Alternative 4 would include all components of Alternative 1 and additionally include:

1. Focused injection of chemical oxidants to reduce contaminant mass in the source area (i.e., groundwater associated with OU1) and portions of the concentrated plume area (i.e., within the 10 ppm [10,000 ppb] contour extending downgradient from the OU1 boundary). Injection locations will be selected to best support subsurface distribution

and therefore, surface contact between the chemical oxidant and the dissolved phase contaminant mass. A field-scale pilot test would be performed as part of the remedial design prior to remedy implementation to estimate oxidant quantities, injection flow rates, and subsurface distribution parameters. For the purposes of the FS, it is assumed that three ISCO applications utilizing modified Fenton's reagent followed by one ISCO application utilizing permanganate will be required for initial treatment. The initial three injections would provide the highest oxidation power to achieve the greatest initial contaminant destruction and to partially desorb PCE. The final injection of permanganate would provide longer-lasting continuing oxidation to treat zones of contamination not directly contacted with the initial three injections of Fenton's reagent.

2. Monitoring of the PCE concentrations throughout the extent of the treatment area.
3. Based upon ISCO applications and performance monitoring, additional ISCO applications may be required to continue treatment of contaminant mass within the saturated zone. As dissolved phase contaminant mass is treated, sorbed and/or residual phase contaminant mass will desorb into the dissolved phase, and therefore may require additional oxidant mass for subsequent treatment. The need for additional ISCO applications will be evaluated based on ongoing performance groundwater monitoring. For the purposes of the FS, it is assumed that two additional permanganate injection events may be required for additional polishing, or finishing treatment.
4. A single groundwater extraction well withdrawing 150 gpm located within the concentrated plume area (i.e., located within the 10 ppm [10,000 ppb] PCE concentration contour) to generate an increased hydraulic gradient in the water table. The increased hydraulic gradient from groundwater flow to the extraction well would potentially increase the area of the plume addressed by the ISCO injection wells, specifically targeting contaminant mass in groundwater located beneath a portion of the existing residences (i.e., along 77<sup>th</sup> Avenue and 78<sup>th</sup> Street).
5. Although groundwater extraction is included principally to generate an hydraulic gradient rather than serve as an extraction and treatment system, the extracted



groundwater will have to be treated. Therefore this alternative includes construction of a treatment system on Edsall Avenue utilizing the treatment process shown on Figure 2-1 to treat extracted groundwater. The treatment system is anticipated to minimally include: an air stripper for the removal of VOCs and vapor phase carbon units to remove contaminants in off-gas from the air stripper. As mentioned in Section 2.4.4.1, other potential components could include: chemical feed system to prevent scaling of the air stripper, pH adjustment of the effluent water which may be increased by the air stripper, additional treatment for MTBE if the air stripper is not capable of treating to the discharge limitations, and an acid scrubber to remove HCl from the oxidizer discharge.

6. Conveyance of treated water to the local combined sanitary/storm sewer system.
7. The ongoing vapor intrusion mitigation program will continue to monitor soil gas levels at adjacent residences and assess the need for additional system sub-slab depressurization installations. Additional system installations will be conducted as necessary in the future to provide mitigation. For the purposes of the FS, it is assumed that three such installations would be performed each year following indoor air sampling during the heating season.

### **3.0 DETAILED DESCRIPTION AND ANALYSIS OF ALTERNATIVES**

This section includes a detailed description, plan view layout, and preliminary cost estimate for each alternative, and an analysis of the alternatives in accordance with the criteria for evaluating alternatives established in 6NYCRR Part 375.

#### **3.1 Description of Evaluation Criteria**

Each of the alternatives is subjected to a detailed analysis with respect to the evaluation criteria outlined in 6 NYCRR Part 375 and described below. This evaluation aids in the selection process for remedial actions in New York State.

##### **Overall Protection of Human Health and the Environment**

This criterion is an overall check to assess whether the alternative meets requirements that are protective of human health and the environment.

##### **Compliance with New York State Standards, Criteria, and Guidance (SCGs)**

This criterion determines how each alternative will meet environmental laws, regulations, and other standards and criteria, including that which NYSDEC has determined to be applicable on a case-specific basis.

##### **Short-term Impacts and Effectiveness**

This criterion assesses the effects of the alternative during the construction and implementation phase with respect to its effect on human health (community and workers) and the environment. The factors that are assessed include protection of the community and workers during remedial action, environmental impacts that result from the remedial action, and time required until the remedial action objectives are achieved.

### **Long-term Effectiveness and Permanence**

This criterion addresses the results of a remedial action in terms of its permanence and the quantity/nature of waste or residuals remaining at the site after remedial action objectives have been met. The primary focus of this evaluation is the extent and effectiveness of the controls that may be required to manage the residuals remaining at the site and the operation and maintenance systems necessary for the remedy to remain effective. Factors that are evaluated include magnitude of remaining risk, adequacy of controls used to manage residual contamination, and the reliability of those controls.

### **Reduction of Toxicity, Mobility and Volume**

This criterion assesses the remedial alternative's use of technologies that permanently reduce toxicity, mobility, and volume (TMV) of contamination as their principal element. NYSDEC gives preference to alternatives that eliminate significant threats at the site through destruction of toxic contaminants, reduction of the total mass of toxic contaminants, irreversible reduction of contaminant mobility, or reduction of the total volume of contaminated media.

### **Implementability**

This criterion addresses the technical and administrative feasibility of implementing the alternative and the availability of various services and materials required during implementation. The evaluation includes the feasibility of construction and operation, the reliability of the technology, the ease of undertaking additional remedial action, monitoring considerations, activities needed to coordinate with regulatory agencies, availability of adequate equipment, services and materials, off-site treatment, and storage and disposal services.

### **Cost**

Capital costs, and operation, maintenance, and monitoring (OM&M) costs are estimated for each alternative and presented on a present worth basis based on a 5% discount rate. Cost

estimates for each remedial alternative are presented in Appendix B and summarized on Table 3-1.

### **Community Acceptance**

Concerns of the State and the community will be addressed after completion of a Proposed Remedial Action Plan (PRAP) that would be prepared and released to the public. Therefore, an evaluation of this criteria is not presented for each alternative within this FS.

## **3.2 Alternative 1 – No Additional Action**

### **3.2.1 Description**

A layout for Alternative 1 is shown on Figure 3-1. The existing IRM would remain in-place and continue to operate using SVE-1, SVE-6S and SVE-6D. In addition, individual sub-slab depressurization systems have been installed at 8 of the 12 residences identified by the NYSDEC and NYSDOH as currently or potentially exposed to contaminated soil vapor. The systems collect soil gasses from beneath the residences and vent them to the atmosphere. The ongoing vapor intrusion mitigation program will continue to monitor soil gas levels at adjacent residences and assess the need for additional system installations.

A ROD has been issued for OU1 by NYSDEC. The No Additional Action Alternative considers that the provisions of that ROD will be implemented creating a new baseline for the site. New components would be added to the remediation and operate until either the remedial objectives for OU1 have been achieved, or until the NYSDEC determines that continued operation is technically impracticable or not feasible. Components include:

1. Six new vapor extraction wells (SVE-7S, SVE-7D, SVE-8S, SVE-8D, SVE-9S, SVE-10S) will be installed in the northern yard (parking lot) north of the existing building. A shallow and deep well pair will be installed at two of the three locations. Well/well pairs will be spaced about 80 feet apart based on an 80-foot radius of

influence determined during the IRM. This spacing and radius of influence provides coverage for the entire OU1 area.

2. A new SVE treatment system will be installed for the six new vapor extraction wells. The new SVE system will be designed to handle about 2.5 times the amount of extracted soil gas as the current IRM. The system will include a moisture separator, two blowers at approximately 260 scfm each, and two 1,000-pound carbon vessels. Extraction wells will be connected to the SVE system by underground pipe.
3. Monitoring of the extracted soil vapor will continue to confirm the effectiveness of the remedy.
4. The ongoing vapor intrusion mitigation program will continue to monitor soil gas levels at adjacent residences and assess the need for additional system sub-slab depressurization installations. Additional system installations will be conducted as necessary in the future to provide mitigation. For the purposes of the FS, it is assumed that three such installations would be performed following indoor air sampling during the heating season.

### **3.2.2 Overall Protection of Human Health and the Environment**

The SVE system will remove residual vadose zone PCE contamination that acts as the source of groundwater contamination. Concentrations of contaminants present within the plume area would be reduced over time by dispersion. Alternative 1 will not provide protection to human health and the environment from contaminants present in groundwater within the plume area.

The ongoing vapor intrusion mitigation program and SVE system at the Kliegman Bros. property will reduce the exposure of VOCs in soil gas to adjacent residents.

### **3.2.3 Compliance with SCGs**

Alternative 1 will not meet SCGs in groundwater within the plume area.

### **3.2.4 Short-Term Impacts and Effectiveness**

There are no short-term impacts to the community, workers, or the environment from the No Additional Action Alternative as it is assumed that construction of the SVE wells and treatment system are complete. Future installations of additional individual sub-slab depressurization systems would be subject to the health and safety plan(s) already in place for such installations and expected potential short-term impacts would be minimal.

### **3.2.5 Long-Term Effectiveness and Permanence**

Alternative 1 would not be effective in reducing the concentrations of contaminants in the groundwater plume that would be reduced over time by dispersion. Residual contamination would continue to pose risks associated with groundwater at the site and remedial action objectives for groundwater would not be met.

RAOs for soil gas will be met with the ongoing vapor intrusion mitigation program and SVE system at the Kliegman Bros. property that will remove VOCs and reduce the exposure of VOCs in soil gas to adjacent residents.

### **3.2.6 Reduction of Toxicity, Mobility, and Volume**

Alternative 1 would not reduce the toxicity, mobility, or volume of groundwater contaminants within the plume.

### **3.2.7 Implementability**

There are limited implementation issues related to the No Additional Action Alternative as it is assumed that SVE components of this alternative are fully implemented and that construction is complete. Sub-slab depressurization systems have already been installed in residences adjacent to the site. Future installations are readily implementable.

### **3.2.8 Cost**

The cost analysis for Alternative 1 is presented in Appendix B. There is no capital cost associated with Alternative 1. It is assumed that three sub-slab depressurization systems will be installed yearly following indoor air sampling during the heating season for 30 years. Table 3-1 presents the annual OM&M cost and total present worth of OM&M costs (based on a 5% discount rate).

### **3.3 Alternative 2A – Groundwater Extraction from Concentrated Plume Area With Above-Ground Water Treatment**

#### **3.3.1 Description**

A conceptual layout of Alternative 2A is shown on Figure 3-2. Alternative 2A would include all components of Alternative 1 and additionally include extraction of groundwater from the concentrated plume area (PCE concentrations >10,000 ppb) with subsequent above-ground treatment. Calculations presented in Appendix A document the process followed to determine the optimal location of a single extraction well. A single extraction well is preferred due to the lack of open space for well locations, the presence of numerous existing subsurface utilities, and the fact that additional equipment may be required for the treatment facility given multiple wells. Based on the evaluation of a variety of configurations as documented in Appendix A, the lowest extraction rate that would be effective in containing the 10,000 ppb plume is 150 gpm with one well located as shown on Figure 3-2. Components of this alternative are:

1. Installation of a single groundwater extraction well withdrawing 150 gpm from the water table groundwater located within the concentrated plume area.
2. A force main to convey extracted groundwater to the treatment system located on Edsall Avenue.
3. Construction of a treatment system to treat extracted groundwater. The treatment system is anticipated to minimally include: an air stripper for the removal of VOCs,

and vapor phase carbon units to remove contaminants in off-gas from the air stripper.

Table 3-2 summarizes the preliminary design criteria for an air stripper that should be able to treat groundwater to the New York City Department of Environmental Protection (NYCDEP) discharge limitations presented in Appendix C. Preliminary modeling by the vendor indicates that MTBE (detected in MW-24D within the concentrated plume area) removal should be feasible without increasing the air flow rate. As mentioned in Section 2.4.4.1, other potential components could include: chemical feed system to prevent scaling of the air stripper, pH adjustment of the effluent water which may be increased by the air stripper, and additional treatment for MTBE if the air stripper is not capable of treating to the discharge limitations,

1. Conveyance of treated water to the local combined sanitary/storm sewer system. A 36" sewer line flows north along 76<sup>th</sup> Street to Edsall Avenue and connects to a 42" sewer line on Cooper Avenue. The NYCDEP sewer map is provided in Appendix C.
2. Operation and maintenance of the extraction well and treatment system.
3. Long-term sampling and analysis of 18 existing monitoring wells.

The ongoing vapor intrusion mitigation program will continue to monitor soil gas levels at adjacent residences and assess the need for additional system sub-slab depressurization installations. Additional system installations will be conducted as necessary in the future to provide mitigation. For the purposes of the FS, it is assumed that three such installations would be performed yearly following indoor air sampling during the heating season.

### **3.3.2 Overall Protection of Human Health and the Environment**

By extracting contaminated groundwater from within the concentrated plume area, Alternative 2A provides protection to human health and the environment. Concentrations of contaminants present within the remaining plume area beyond the 10,000 ppb contour would be reduced over time by dispersion. Long-term groundwater monitoring included with this alternative would aid in the determination of the degree to which remediation is meeting remedial



goals. Remediation would continue until monitoring results indicated an acceptable level of residual risk.

The ongoing vapor intrusion mitigation program and the SVE system at the Kliegman Bros. property will reduce the exposure of VOCs in soil gas to adjacent residents.

### **3.3.3 Compliance with SCGs**

Groundwater extraction from within the concentrated plume would improve groundwater quality in the aquifer. Remediation could continue until groundwater monitoring results indicated that remedial goals had been met. Discharge requirements for treated groundwater to the local sewer system would be SCGs. Air emissions from the groundwater treatment facility would have to meet appropriate SCGs.

### **3.3.4 Short-Term Impacts and Effectiveness**

It is anticipated that construction of the groundwater extraction, treatment and discharge systems would be completed between 6 months to 1 year. Short-term impacts to workers and the community during this time period would not necessarily pose a risk to human health and/or the environment as the majority of drilling and subsurface activities would be performed outside the limits of the source area. Minimal impacts would be present once contaminated groundwater was encountered during drilling of the extraction well.

### **3.3.5 Long-Term Effectiveness and Permanence**

Alternative 2A would be effective in reducing the contaminants in groundwater within the concentrated plume area. Concentrations of contaminants present within the remaining plume area beyond the 10,000 ppb contour would be reduced over time by dispersion. Long-term groundwater monitoring included with this alternative would aid in the determination of the degree to which remediation is meeting remedial goals. Remediation would continue until monitoring results indicated an acceptable level of residual risk.

RAOs for soil gas will be met with the ongoing vapor intrusion mitigation program and the SVE system at the Kliegman Bros. property that will reduce the exposure of VOCs in soil gas to adjacent residents.

### **3.3.6 Reduction of Toxicity, Mobility, and Volume**

Extraction and treatment of groundwater from within the concentrated plume area will reduce the mobility of contaminants present in groundwater within this area. URS estimates there are about 1,100 lb (pounds) of PCE dissolved in the saturated zone to the extent of contamination defined by the 10,000 µg/L isoconcentration line, and another 200 lb in the zone between the 10,000 µg/L and the 1,000 µg/L contours. With groundwater extraction and treatment, residual DNAPL in the saturated zone would only be partially removed. The mass of DNAPL present in the saturated zone can not be calculated. The magnitude of untreated residuals in the untreated downgradient plume would remain at 200 lb. Groundwater treatment will satisfy NYSDEC's preference for treatment and reduce the toxicity of the contaminants.

### **3.3.7 Implementability**

Given the limitations on the amount of open space available for the facilities and the presence of numerous subsurface utilities, many considerations will have to be undertaken to locate the components of this alternative in acceptable areas. Construction of the extraction well, groundwater treatment system, and force main themselves would not be difficult. However, administrative issues such as traffic concerns and citing these in a residential area may make approvals difficult to obtain. Materials and services for construction and operation would be readily available. Regulations regarding construction and operation in a residential area would prevail throughout the remediation period that is expected to be over a long time period (i.e., 30 years).

### **3.3.8 Cost**

The cost analysis for Alternative 2A is presented in Appendix B. Table 3-1 presents the capital cost, annual OM&M cost and total present worth of OM&M costs (based on a 5% discount rate). It is assumed that the systems will operate for 30 years after construction in order to complete remediation.

## **3.4 Alternative 2B –Groundwater Extraction from Expanded Plume Area with Above-Ground Water Treatment**

### **3.4.1 Description**

A conceptual layout for Alternative 2B is shown on Figure 3-3. Alternative 2B would include all components of Alternative 1 and additionally include groundwater extraction from the expanded plume area (PCE concentrations >1,000 ppb) with subsequent above-ground treatment. Calculations presented in Appendix A document the process followed to determine the optimal location of extraction wells. A minimum number of extraction wells is preferred due to the lack of open space for well locations, the presence of numerous existing subsurface utilities, and the fact that additional equipment (e.g., equalization tanks) may be required for the treatment facility given multiple wells. Based on the evaluation of a variety of configurations as documented in Appendix A, the lowest extraction rate that would be effective in containing the 1,000 ppb plume is 300 gpm with two wells located as shown on Figure 3-3. Components of this alternative are:

1. Installation of two groundwater extraction wells withdrawing a total of 300 gpm from the water table groundwater located within the expanded plume area.
2. A force main to connect the wells and convey extracted groundwater to the treatment system located on Edsall Ave.
3. Construction of a treatment system to treat extracted groundwater. The treatment system is anticipated to minimally include: an air stripper for the removal of VOCs, and vapor phase carbon units to remove contaminants in off-gas from the air stripper.

Table 3-2 summarizes the preliminary design criteria for an air stripper that should be able to treat groundwater to the NYCDEP discharge limitations presented in Appendix C. Preliminary modeling from the air stripper vendor indicates that MTBE (detected in MW-24D within the concentrated plume area) removal via air stripping significantly increases the air flow rate required at a groundwater flow rate of 300 gpm. As mentioned in Section 2.4.4.1, other potential components could include: chemical feed system to prevent scaling of the air stripper, pH adjustment of the effluent water which may be increased by the air stripper, additional treatment for MTBE if the air stripper is not capable of treating to the discharge limitations, and an acid scrubber to remove HCl from the oxidizer discharge.

1. Conveyance of treated water to the local combined sanitary/storm sewer system. A 36" sewer line flows north along 76<sup>th</sup> Street to Edsall Ave. and connects to a 42" sewer line on Cooper Avenue. The NYCDEP sewer map is provided in Appendix C.
2. Operation and maintenance of the extraction well and treatment system.
3. Long-term sampling and analysis of 18 existing monitoring wells.

The ongoing vapor intrusion mitigation program will continue to monitor soil gas levels at adjacent residences and assess the need for additional system sub-slab depressurization installations. Additional system installations will be conducted as necessary in the future to provide mitigation. For the purposes of the FS, it is assumed that three such installations would be performed yearly following indoor air sampling during the heating season.

### **3.4.2 Overall Protection of Human Health and the Environment**

By extracting contaminated groundwater from within the expanded plume area, Alternative 2B provides protection to human health and the environment. Concentrations of contaminants present outside the anticipated capture zone would be reduced over time by dispersion. Long-term groundwater monitoring included with this alternative would aid in the determination of the degree to which remediation is meeting remedial goals. Remediation would continue until monitoring results indicated an acceptable level of residual risk.

The ongoing vapor intrusion mitigation program and the SVE system at the Kliegman Bros. property will reduce the exposure of VOCs in soil gas to adjacent residents.

### **3.4.3 Compliance with SCGs**

Groundwater extraction from within the expanded plume would improve groundwater quality in the aquifer. Remediation could continue until groundwater monitoring results indicated that remedial goals had been met. Discharge requirements for treated groundwater to the local sewer system would be SCGs. Air emissions from the groundwater treatment facility would have to meet appropriate SCGs.

### **3.4.4 Short-Term Impacts and Effectiveness**

It is anticipated that construction of the groundwater extraction, treatment and discharge systems would be completed in less than 1 year. Short-term impacts to workers and the community during this time period would not necessarily pose a risk to human health and/or the environment as the majority of drilling and subsurface activities would be performed outside the limits of the source area. Minimal impacts would be present once contaminated groundwater was encountered during drilling of the extraction wells.

### **3.4.5 Long-Term Effectiveness and Permanence**

Alternative 2B would be effective in reducing contaminants in groundwater within the expanded plume area. Concentrations of contaminants outside the anticipated capture zone would be reduced over time by dispersion. Long-term groundwater monitoring included with this alternative would aid in the determination of the degree to which remediation is meeting remedial goals. Remediation would continue until monitoring results indicated an acceptable level of residual risk.

RAOs for soil gas will be met with the ongoing vapor intrusion mitigation program and the SVE system at the Kliegman Bros. property that will reduce the exposure of VOCs in soil gas to adjacent residents.

### **3.4.6 Reduction of Toxicity, Mobility, and Volume**

Extraction and treatment of groundwater from within the expanded plume area will reduce the mobility of contaminants present in groundwater within this area. URS estimates there are about 1,100 lb of PCE dissolved in the saturated zone to the extent of contamination defined by the 10,000 µg/L isoconcentration line, and another 200 lb in the zone between the 10,000 µg/L and the 1,000 µg/L contours. With groundwater extraction and treatment, residual DNAPL in the saturated zone would only be partially removed. The mass of DNAPL present in the saturated zone can not be calculated. The magnitude of untreated residuals in the untreated downgradient plume would be less than 200 lb (i.e., less than for Alternative 2A). Groundwater treatment will satisfy NYSDEC's preference for treatment and reduce the toxicity of the contaminants.

### **3.4.7 Implementability**

Given the limitations on the amount of open space available for the facilities and the presence of numerous subsurface utilities, many considerations will have to be undertaken to locate the components of this alternative in acceptable areas. Construction of the extraction wells, groundwater treatment system, and force mains themselves would not be difficult. However, administrative issues such as traffic concerns and citing these in a residential area may make approvals difficult to obtain. Materials and services for construction and operation would be readily available. Regulations regarding construction and operation in a residential area would prevail throughout the remediation period that is expected to be over a long time period (i.e., 30 years).

### **3.4.8 Cost**

The cost analysis for Alternative 2B is presented in Appendix B. Table 3-1 presents the capital cost, annual OM&M cost and total present worth of OM&M costs (based on a 5% discount rate). It is assumed that the systems will operate for 30 years after construction in order to complete remediation.

## **3.5 Alternative 3A – In Situ Chemical Oxidation Treatment of Concentrated Plume Area**

### **3.5.1 Description**

A conceptual layout for Alternative 3A is shown on Figure 3-4. Alternative 3A would include all components of Alternative 1 and additionally include the use of chemical oxidants to address groundwater contamination in the source area (including groundwater associated with OU1) and within the 10,000 ppb PCE contour (i.e., the concentrated plume area). The selected oxidants will be delivered in four to six injection events implemented over a three-year time period.

For the purposes of the FS, it is assumed that three ISCO applications utilizing modified Fenton's reagent followed by one ISCO application utilizing permanganate will be required for initial treatment. Two additional permanganate injection events may be required for additional polishing, or finishing treatment. For costing purposes, it is assumed these two additional injections would be necessary. The focused treatment area incorporated in Alternative 3A is intended to oxidize contaminants within the source area and concentrated plume, thus reducing the overall contaminant mass within the plume. Bench- and/or field-scale pilot testing will be required to determine the appropriate oxidants and estimate oxidant quantities to be delivered during each injection event. Components of this alternative are:

1. Groundwater and soil samples would be collected for laboratory bench-scale testing to evaluate oxidant demand in addition to the target contaminants (e.g., PCE). Soil

buffering capacity (i.e., the ability of the aquifer to maintain a stable pH) and the potential for precipitate generation and/or metals leaching may also be evaluated.

2. Approximately four injection wells would be installed near groundwater monitoring well MW-02D, in the parking lot north of the Kliegman Bros. property (i.e., north of rail road) for field-scale pilot testing prior to full-scale implementation. The pilot test would evaluate injection flow rates, subsurface distribution, and other implementation parameters.
3. Three existing groundwater monitoring wells (e.g., MW-11D, MW-02D, and MW-10D) would be used to evaluate subsurface distribution and oxidant impact during the pilot test. Up to four rounds of groundwater monitoring would be conducted in the four months following the field-scale pilot test. This information would be used to complete the remedial design for the full-scale implementation.
4. Prior to beginning the implementation of the full-scale portion of this Alternative, a baseline groundwater monitoring event would be performed at the 18 existing area monitoring wells.
5. Approximately 85 injection locations would be installed on the OU1 and concentrated plume areas (Figure 3-4). Approximately 15 locations would be installed on the OU1 property on 15- to 20-foot centers, within the building yard as possible. Approximately 70 locations would be installed within the concentrated area of the plume on 30-foot centers in an effort to achieve adequate subsurface distribution providing surface contact between the injected oxidant and the dissolved phase contaminant mass. Due to the existing residential nature of the site, injection wells would be located in sidewalk areas and, if possible, a few additional spaces (e.g., driveways, etc.) to increase subsurface distribution (Figure 3-4). Each injection well would be constructed using 2-inch PVC piping with 10- to 15-foot length screens positioned across the treatment zone (e.g., between 70 and 100 feet bgs).
6. Each modified Fenton's reagent or permanganate ISCO injection event would be expected to last a few weeks to one month.



8. Following the third modified Fenton's reagent and the planned permanganate injection, two performance monitoring events would be performed four to eight weeks after completion of injection activities to determine contaminant mass reduction in comparison to baseline groundwater concentrations and subsurface distribution of injection oxidant material.
9. If the monitoring events after the default injection events (three Fenton's reagent and one permanganate) show rebound occurs, additional injections of permanganate would be required. Following each of these injections, two performance monitoring events would be performed four to eight weeks after completion of injection activities to determine contaminant mass reduction in comparison to baseline groundwater concentrations and subsurface distribution of injection oxidant material. For costing purposes, two such additional injection events are assumed.
10. Additional groundwater monitoring of the 18 existing monitoring wells would be conducted two times after the final injection event.
11. The ongoing vapor intrusion mitigation program would continue to monitor soil gas levels at adjacent residences and assess the need for additional system sub-slab depressurization installations. Additional system installations would be conducted as necessary in the future to provide mitigation. For the purposes of the FS, it is assumed that three such installations would be performed yearly following indoor air sampling during the heating season.

### **3.5.2 Overall Protection of Human Health and the Environment**

By chemically oxidizing (i.e., treating) the contaminants in groundwater within the source area and concentrated plume area with an injection material demonstrated to be effective by bench- and/or pilot-scale testing, Alternative 3A would provide protection to human health and the environment. Concentrations of contaminants (e.g., PCE) present within the remaining plume area outside the 10,000 ppb (i.e., 10 ppm) PCE concentration contour would be reduced over time by dispersion. Groundwater monitoring included with this alternative would aid in the

determination of the degree to which remediation is meeting remedial goals. Remediation may then be continued until monitoring results indicated an acceptable level of residual risk.

The ongoing vapor intrusion mitigation program and the SVE system at the Kliegman Bros. property will reduce the exposure of VOCs in soil gas to adjacent residents.

### **3.5.3 Compliance with SCGs**

Chemical oxidation within the source area and concentrated plume would improve groundwater quality regarding organic contaminants (i.e., PCE) within the aquifer.

### **3.5.4 Short-Term Impacts and Effectiveness**

It is anticipated that implementation of this alternative would require about 3 years from well installation/initial injection through performance monitoring following the full-scale implementation. Bench- and field-scale pilot testing is expected to be performed during the design phase, including up to four rounds of performance monitoring following the pilot test. The estimated implementation timeframe for the initial baseline groundwater monitoring event, three modified Fenton's reagent injection events, three permanganate injection events, and 14 performance monitoring events is approximately 3 years with each ISCO injection event is expected to last a few weeks to one month, and each groundwater monitoring event to last approximately one week.

During ISCO injection events, site vehicles and equipment will be temporarily stored along the Kliegman Bros. property and/or parked/staged along city streets. Access to the north parking lot will be required for implementation of the pilot test and baseline and performance groundwater monitoring activities. Access to the Kliegman Bros. property yard will be required for baseline and performance groundwater monitoring activities and implementation of the pilot test and full-scale implementation. Other short-term impacts during the implementation of the field-scale pilot test and full-scale implementation are expected to be minimal.

Short-term impacts to workers and the community during this time period would be mitigated through a site-specific health and safety plan (HASP). Intrusive activities (e.g., drilling) would be performed within the limits of the source area and concentrated plume (i.e., within the 10,000 ppb [10 ppm] PCE concentration contour); however, impacts would be mitigated with personal protective equipment (PPE) and other measures under the guidance of a site-specific HASP. Additional health and safety considerations to the community would have to be addressed as drilling may be conducted on residential property/properties. The risk from the materials required for the chemical injection is limited; safety and handling and storage requirement for chemical oxidants will be included in the site-specific HASP.

### **3.5.5 Long-Term Effectiveness and Permanence**

Alternative 3A would be effective in reducing the concentrations of contaminants (e.g., PCE) in groundwater within the source area and concentrated plume area. Concentrations of contaminants outside the anticipated treatment zone would be reduced over time by dispersion. Groundwater monitoring included with this alternative would aid in the determination of the degree to which remediation is meeting remedial goals. Remediation may then be continued until monitoring results indicated an acceptable level of residual risk.

If zones of DNAPL exist (this is likely based on observed groundwater concentrations), as dissolved phase contaminant mass is treated, residual or sorbed phase DNAPL will transfer to the dissolved phase. Due to the existing dissolved phase PCE concentrations, following the first two to three ISCO applications the mass transfer of DNAPL to the dissolved phase may occur after the delivered oxidant volume has been expended. Therefore, performance monitoring will be used to evaluate the level of overall contaminant mass removal compared to baseline PCE concentrations. Additional ISCO events will be implemented as needed based upon this evaluation of overall contaminant mass removal in comparison to site remedial goals.

RAOs for soil gas will be met with the ongoing vapor intrusion mitigation program and SVE system at the Kliegman Bros. property that will reduce the exposure of VOCs in soil gas to adjacent residents.

### **3.5.6 Reduction of Toxicity, Mobility, and Volume**

Treatment utilizing ISCO within the source area and concentrated plume area will reduce the toxicity of contaminants present in groundwater within this area. This alternative will satisfy NYSDEC's preference for treatment. URS estimates there are about 1,100 lb of PCE dissolved in the saturated zone to the extent of contamination defined by the 10,000 µg/L isoconcentration line, and another 200 lb in the zone between the 10,000 µg/L and the 1,000 µg/L contours. However, the mass near the source is likely much higher depending on the extent to which residual DNAPL is present. Based on the amount of PCE removed by the SVE IRM, there were tens of thousands of kilograms of PCE present in the vadose zone, suggesting the possibility of high DNAPL mass in the saturated zone as well. Assuming that ISCO destroys 95% of the PCE present, approximately 55 lb of dissolved PCE would remain within the 10,000 µg/L isoconcentration line and an additional 200 lb or so would remain dissolved in the groundwater outside this contour. The remaining PCE would not be uniformly distributed, but would be present in localized areas where oxidant had not penetrated, such as localized low permeability zones or areas unreachable due to the presence of buildings and other limitations of the injection pattern. Outside the source area, wherever the injected oxidant reaches, PCE concentrations are expected to be reduced to levels near or below the SCG value. In the source area, where residual DNAPL may be present, concentrations may be above the SCG value, even after the additional follow-on injections to address rebound.

### **3.5.7 Implementability**

Construction of the individual injection wells would not be difficult. However, the magnitude of the effort may be noticeable to the residents of the neighborhood. Given the limitations of the amount of open space available for the facilities, the active nature of the business at the Kliegman Bros. property, and the presence of numerous subsurface utilities, locating the injection wells in an effective and properly spaced grid pattern will be challenging. Materials and services for construction and operation would be readily available. Regulations regarding construction and operation in a residential area would prevail throughout the remediation considering that the on-site implementation (i.e., time required for installation of injection wells associated with pilot test and full-scale activities).

### **3.5.8 Cost**

The cost analysis for Alternative 3A is presented in Appendix B. Table 3-1 presents the capital cost, annual OM&M cost and total present worth of OM&M costs (based on a 5% discount rate). Although the injection events will occur over the course of 3 years, the costs for all injection events are considered capital costs.

## **3.6 Alternative 3B – In Situ Chemical Oxidation Treatment of Expanded Plume Area**

### **3.6.1 Description**

A conceptual layout for Alternative 3B is shown on Figure 3-5. Alternative 3B would include all components of Alternatives 1 and 3A, and additionally include the use of chemical oxidants to address groundwater contamination within the within the expanded plume (i.e., within the 1 ppm [1,000 ppb] PCE concentration contour). The selected oxidants will be delivered in up to six injection events implemented over a 3-year time period. The overall treatment timeframe for Alternatives 3A and 3B are expected to be the same; however, Alternative 3B will be completed in a similar amount of time by increasing the number of field personnel and injection equipment for full-scale implementation.

For the purposes of the FS, it is assumed that three ISCO applications utilizing modified Fenton's reagent followed by one ISCO application utilizing permanganate would be required for initial treatment. Two additional permanganate injection events may be required for additional polishing, or finishing treatment. The treatment area incorporated in Alternative 3B is intended to oxidize contaminants within the source area (including groundwater associated with OU1), the concentrated plume area (i.e., within the 10 ppm [10,000 ppb] contour extending downgradient from the OU1 boundary), and within the expanded plume (i.e., within the 1 ppm [1,000 ppb] PCE concentration contour), thus reducing the overall contaminant mass within the plume. Bench- and/or field-scale pilot testing would be required to determine the appropriate oxidants and estimate oxidant quantities to be delivered during each injection event. Components of this alternative are:

1. Groundwater and soil samples would be collected for laboratory bench-scale testing to evaluate oxidant demand in addition to the target contaminants (e.g., PCE). Soil buffering capacity (i.e., the ability of the aquifer to maintain a stable pH) and the potential for precipitate generation and/or metals leaching may also be evaluated.
2. Approximately four injection wells would be installed near groundwater monitoring well MW-02D, in the parking lot north of the Kliegman Bros. property (i.e., north of rail road) for field-scale pilot testing prior to full-scale implementation. The pilot test would evaluate injection flow rates, subsurface distribution, and other implementation parameters.
3. Three existing groundwater monitoring wells (e.g., MW-11D, MW-02D, and MW-10D) would be used to evaluate subsurface distribution and oxidant impact during the pilot test. Up to four rounds of groundwater monitoring would be conducted in the four months following the field-scale pilot test. This information would be used to complete the remedial design for the full-scale implementation.
4. Prior to beginning the implementation of the full-scale portion of this Alternative, a baseline groundwater monitoring event would be performed at the 18 existing area monitoring wells.
5. Approximately 155 injection locations would be installed on the OU1, concentrated, and expanded plume areas (Figure 3-5). Approximately 15 locations would be installed on the OU1 property on 15- to 20-foot centers, within the Kliegman Bros. property yard, as possible. In an effort to achieve adequate subsurface distribution providing surface contact between the injected oxidant and the dissolved phase contaminant mass, approximately 70 locations would be installed within the concentrated area of the plume on 30-foot centers, and approximately 70 locations would be installed within the expanded portion of the plume on 60-foot centers. Due to the existing residential nature of the site, injection wells would be located in sidewalk areas and, if possible, a few additional spaces (e.g., driveways, etc.) to increase subsurface distribution (Figure 3-5). Each injection well would be constructed using 2-inch PVC piping with 10- to 15-foot length screens positioned across the treatment zone (e.g., between 70 and 100 feet bgs).

6. Each modified Fenton's reagent or permanganate ISCO injection event is expected to last a few weeks to one month.
7. Following the first two modified Fenton's reagent injection events, one performance monitoring event would be performed four to eight weeks after completion of injection activities to determine contaminant mass reduction in comparison to baseline groundwater concentrations and subsurface distribution of the injected oxidant material (i.e., oxidant impact).
12. Following the third modified Fenton's reagent and the planned permanganate injection, two performance monitoring events would be performed four to eight weeks after completion of injection activities to determine contaminant mass reduction in comparison to baseline groundwater concentrations and subsurface distribution of injection oxidant material.
13. If the monitoring events after the default injection events (three modified Fenton's reagent and one permanganate) show rebound occurs, additional injections of permanganate would be required. Following each of these injections, two performance monitoring events would be performed four to eight weeks after completion of injection activities to determine contaminant mass reduction in comparison to baseline groundwater concentrations and subsurface distribution of injection oxidant material. For costing purposes, two such additional injection events are assumed.
14. Additional groundwater monitoring of the 18 existing monitoring wells would be conducted two times following the completion of ISCO injections.
15. The ongoing vapor intrusion mitigation program would continue to monitor soil gas levels at adjacent residences and assess the need for additional system sub-slab depressurization installations. Additional system installations would be conducted as necessary in the future to provide mitigation. For the purposes of the FS, it is assumed that three such installations would be performed yearly following indoor air sampling during the heating season.

### **3.6.2 Overall Protection of Human Health and the Environment**

By chemically oxidizing (i.e., treating) the contaminants in groundwater within the source area and expanded plume area with an injection material demonstrated to be effective by the bench- and/or pilot-scale testing, Alternative 3B would provide protection to human health and the environment. Concentrations of contaminants (e.g., PCE) present in the area outside the plume would be reduced over time by dispersion. Groundwater monitoring included with this alternative would aid in the determination of the degree to which remediation is meeting remedial goals. Remediation may then be continued until monitoring results indicated an acceptable level of residual risk.

The ongoing vapor intrusion mitigation program and the SVE system at the Kliegman Bros. property will reduce the exposure of VOCs in soil gas to adjacent residents.

### **3.6.3 Compliance with SCGs**

Chemical oxidation within the source area and expanded plume would improve groundwater quality regarding organic contaminants (e.g., PCE) in the aquifer.

### **3.6.4 Short-Term Impacts and Effectiveness**

It is anticipated that implementation of this alternative would require about 3 years from well installation/initial injection through performance monitoring following the full-scale implementation. Bench- and field-scale pilot testing is expected to be performed during the design phase, including up to four rounds of performance monitoring following the pilot test. The estimated implementation timeframe for the initial baseline groundwater monitoring event, three modified Fenton's reagent injection events, three permanganate injection events, and 14 performance monitoring events is approximately 3 years with each ISCO injection event is expected to last a few weeks to one month, and each groundwater monitoring event to last approximately one week.



During ISCO injection events, site vehicles and equipment will be temporarily stored along the Kliegman Bros. property and/or parked/staged along city streets. Access to the north parking lot will be required for implementation of the pilot test and baseline and performance groundwater monitoring activities. Access to the Kliegman Bros. property yard will be required for baseline and performance groundwater monitoring activities and implementation of the pilot test and full-scale implementation. Other short-term impacts during the implementation of the field-scale pilot test and full-scale implementation are expected to be minimal, although slightly more in comparison to Alternative 3A.

Short-term impacts to workers and the community during this time period would be mitigated through a site-specific health and safety plan (HASP). Intrusive activities (e.g., drilling) would be performed within the limits of the source area, concentrated plume and expanded plume (i.e., within the 10,000 and 1,000 ppb [10 and 1 ppm] PCE concentration contours); however, impacts would be mitigated with personal protective equipment (PPE) and other measures under the guidance of a site-specific HASP. Additional health and safety considerations to the community would have to be addressed as drilling may be conducted on residential property/properties. The risk from the materials required for the chemical injection is limited; safety and handling and storage requirement for chemical oxidants will be included in the site-specific HASP.

### **3.6.5 Long-Term Effectiveness and Permanence**

Alternative 3B would be effective in reducing the concentrations of contaminants in groundwater within the source, concentrated plume, and expanded plume areas. Concentrations of contaminants (e.g., PCE) outside the anticipated treatment zone would be reduced over time by dispersion. Groundwater monitoring included with this alternative would aid in the determination of the degree to which remediation is meeting remedial goals. Remediation may then be continued until monitoring results indicated an acceptable level of residual risk.

If zones of DNAPL exist (this is likely based on observed groundwater concentrations), as dissolved phase contaminant mass is treated, residual or sorbed phase DNAPL will transfer to

the dissolved phase. Due to the existing dissolved phase PCE concentrations, following the first two to three ISCO applications the mass transfer of DNAPL to the dissolved phase may occur after the delivered oxidant volume has been expended. Therefore, performance monitoring will be used to evaluate the level of overall contaminant mass removal compared to baseline PCE concentrations. Additional ISCO events will be implemented as needed based upon this evaluation of overall contaminant mass removal in comparison to site remedial goals.

RAOs for soil gas will be met with the ongoing vapor intrusion mitigation program and SVE system at the Kliegman Bros. property that will remove VOCs and reduce the exposure of VOCs in soil gas to adjacent residents.

### **3.6.6 Reduction of Toxicity, Mobility, and Volume**

In situ chemical oxidation within the source, concentrated plume, and expanded plume area will reduce the toxicity of contaminants present in groundwater within these areas. URS estimates there are about 1,100 lb of PCE dissolved in the saturated zone to the extent of contamination defined by the 10,000 µg/L isoconcentration line, and another 200 lb in the zone between the 10,000 µg/L and the 1,000 µg/L contours. However, the mass near the source is likely much higher depending on the extent to which residual DNAPL is present. Assuming that ISCO destroys 95% of the PCE present, approximately 65 lb of dissolved PCE would remain. The remaining PCE would not be uniformly distributed, but would be present in localized areas where oxidant had not penetrated, such as localized low permeability zones or areas unreachable due to the presence of buildings and other limitations on the injection pattern. Outside the source area, wherever the injected oxidant reaches, PCE concentrations are expected to be reduced to levels near or below the SCG value. In the source area, where residual DNAPL may be present, concentrations may be above the SCG value, even after the additional follow-on injections to address rebound. This alternative will satisfy NYSDEC's preference for treatment.

### **3.6.7 Implementability**

Construction of the individual injection wells would not be difficult. However, the magnitude of the effort may be noticeable to the residents of the neighborhood. Given the limitations of the amount of open space available for the facilities, the active nature of the business at the Kliegman Bros. property, and the presence of numerous subsurface utilities, locating the injection wells in an effective and properly-spaced grid pattern will be challenging. Materials and services for construction and operation would be readily available. Regulations regarding construction and operation in a residential area would prevail throughout the remediation considering that the on-site implementation (i.e., time required for installation of injection wells associated with pilot test and full-scale activities).

### **3.6.8 Cost**

The cost analysis for Alternative 3B is presented in Appendix B. Table 3-1 presents the capital cost, annual OM&M cost and total present worth of OM&M costs (based on a 5% discount rate). Although the injection events will occur over the course of 3 years, the costs for all injection events are considered capital costs.

## **3.7 Alternative 4 - In Situ Chemical Oxidation Treatment of Concentrated Plume Area with Induced Groundwater Gradient**

### **3.7.1 Description**

A conceptual layout for Alternative 4 is shown on Figure 3-6. Alternative 4 would include all components of Alternative 1 and additionally combines a similar ISCO approach presented in Alternative 3A with a groundwater extraction well to induce a gradient within the saturated zone. This alternative includes the use of chemical oxidants to address groundwater contamination in the source area (including groundwater associated with OU1) and within the concentrated plume area (i.e., within the 10,000 ppb [10 ppm] PCE concentration contour). The selected oxidants will be delivered in up to six injection events implemented over a 3-year time

period. In addition to the ISCO component, Alternative 4 incorporates an extraction well to generate a groundwater gradient that would promote migration of the injected reagent over a larger portion of the plume, including beneath existing structures where access for injection may not be feasible.

For the purposes of the FS, it is assumed that three ISCO applications utilizing modified Fenton's reagent followed by one ISCO application utilizing permanganate will be required for initial treatment. Two additional permanganate injection events may be required for additional polishing, or finishing treatment. The focused treatment area incorporated in Alternative 4 is intended to oxidize contaminants within the source area and concentrated plume, thus reducing the overall contaminant mass within the plume. Bench- and/or field-scale pilot testing will be required to determine the appropriate oxidants and estimate oxidant quantities to be delivered during each injection event. Components of this alternative are:

1. Groundwater and soil samples would be collected for laboratory bench-scale testing to evaluate oxidant demand in addition to the target contaminants (e.g., PCE). Soil buffering capacity (i.e., the ability of the aquifer to maintain a stable pH) and the potential for precipitate generation and/or metals leaching may also be evaluated.
2. Approximately four injection wells would be installed near groundwater monitoring well MW-02D, in the parking lot north of the Kliegman Bros. property (i.e., north of rail road) for field-scale pilot testing prior to full-scale implementation. The pilot test would evaluate injection flow rates, subsurface distribution, and other implementation parameters.
3. Three existing groundwater monitoring wells (e.g., MW-11D, MW-02D, and MW-10D) would be used to evaluate subsurface distribution and oxidant impact during the pilot test. Up to four rounds of groundwater monitoring would be conducted in the four months following the field-scale pilot test. This information would be used to complete the remedial design for the full-scale implementation.

4. Prior to beginning the implementation of the full-scale portion of this Alternative, a baseline groundwater monitoring event would be performed at the 18 existing area monitoring wells.
5. Approximately 60 injection locations would be installed on the OU1 and within the concentrated plume areas (Figure 3-6). Approximately 15 locations would be installed on the OU1 property on 15- to 20-foot centers, within the building yard as possible. Approximately 45 locations would be installed within the concentrated area of the plume on 30-foot centers in an effort to achieve adequate subsurface distribution providing surface contact between the injected oxidant and the dissolved phase contaminant mass. In addition, injection wells would be located to support the migration of delivered oxidant from the injection well through the aquifer under existing structures (e.g., residential properties). Due to the existing residential nature of the site, injection wells would be located in sidewalk areas and, if possible, a few additional spaces (e.g., driveways, etc.) to increase subsurface distribution (Figure 3-6). Each injection well will be constructed using 2-inch PVC piping with 10- to 15-foot length screens positioned across the treatment zone (e.g., between 70 and 100 feet bgs).
6. Each modified Fenton's reagent or permanganate ISCO injection event is expected to last a few weeks to one month.
7. Following the first two modified Fenton's reagent injection events, one performance monitoring event would be performed four to eight weeks after completion of injection activities to determine contaminant mass reduction in comparison to baseline groundwater concentrations and subsurface distribution of the injected oxidant material (i.e., oxidant impact).
8. Following the third modified Fenton's reagent and the planned permanganate injection, two performance monitoring events would be performed four to eight weeks after completion of injection activities to determine contaminant mass reduction in comparison to baseline groundwater concentrations and subsurface distribution of injection oxidant material.

9. If the monitoring events after the default injection events (three modified Fenton's reagent and one permanganate) show rebound occurs, additional injections of permanganate would be required. Following each of these injections, two performance monitoring events would be performed four to eight weeks after completion of injection activities to determine contaminant mass reduction in comparison to baseline groundwater concentrations and subsurface distribution of injection oxidant material. For costing purposes, two such additional injection events are assumed.
10. Additional groundwater monitoring of the 18 existing monitoring wells would be conducted two times following the completion of ISCO injection.
11. The ongoing vapor intrusion mitigation program will continue to monitor soil gas levels at adjacent residences and assess the need for additional system sub-slab depressurization installations. Additional system installations will be conducted as necessary in the future to provide mitigation. For the purposes of the FS, it is assumed that three such installations would be performed yearly following indoor air sampling during the heating season.
12. A groundwater extraction well in the concentrated plume area (i.e., within the 10,000 ppb [10 ppm] PCE concentration contour) to generate an increased hydraulic gradient in the water table. The increased hydraulic gradient from groundwater flow to the extraction well would increase the area of the plume addressed by the limited access for injection well installation available due to the residential nature of the area. Calculations presented in Appendix A document the process to determine the optimal location of a single extraction well. A single extraction well is preferred due to the lack of open space for well location, the presence of numerous existing subsurface utilities, and the fact that additional equipment may be required for the treatment facility given multiple wells. Based on the evaluation of a variety of configurations as documented in Appendix A, the lowest extraction rate that would be effective in containing the 10,000 ppb plume is 150 gpm with one well located as shown on Figure 3-6.

13. Although groundwater extraction is included principally to generate an hydraulic gradient rather than serve as an extraction and treatment system, the extracted groundwater will have to be treated. Therefore the alternative includes construction of a treatment system on Edsall Ave. to treat extracted groundwater. The treatment system is anticipated to minimally include: an air stripper for the removal of VOCs and vapor phase carbon units to remove contaminants in off-gas from the air stripper.
14. Conveyance of treated water to the local combined sanitary/storm sewer system. A 36" sewer line flows north along 76<sup>th</sup> Street to Edsall Ave. and connects to a 42" sewer line on Cooper Avenue. The NYCDEP sewer map is provided in Appendix C.
15. Operation and maintenance of the extraction well and treatment system for a period of 3 years (i.e. throughout the period of ISCO treatment).
16. The ongoing vapor intrusion mitigation program will continue to monitor soil gas levels at adjacent residences and assess the need for additional system sub-slab depressurization installations. Additional system installations will be conducted as necessary in the future to provide mitigation. For the purposes of the FS, it is assumed that three such installations would be performed yearly following indoor air sampling during the heating season.

### **3.7.2 Overall Protection of Human Health and the Environment**

Alternative 4 provides protection to human health and the environment by treating the contaminants in groundwater (e.g., PCE) via chemical oxidation with an injection material demonstrated to be effective. The increased hydraulic gradient from groundwater flow to the extraction well would increase the contact area and thus the effectiveness of the ISCO process. Contaminants mass (e.g., PCE) present within the remaining plume area beyond the 10,000 ppb contour would be reduced over time by dispersion. Groundwater monitoring included with this alternative would aid in the determination of the degree to which remediation is meeting remedial goals.

The ongoing vapor intrusion mitigation program and the SVE system at the Kliegman Bros. property will remove VOCs and reduce the exposure of VOCs in soil gas to adjacent residents.

### **3.7.3 Compliance with SCGs**

Chemical oxidation and groundwater extraction from within the source area and the concentrated plume would improve groundwater quality regarding organic contaminants (e.g., PCE) in the aquifer. Discharge requirements to the local sewer system for treated groundwater would be SCGs. Air emissions from the groundwater treatment facility would have to meet appropriate SCGs.

### **3.7.4 Short-Term Impacts and Effectiveness**

It is anticipated that implementation of this alternative would require about 3 years from well installation/initial injection through performance monitoring following the full-scale implementation. Bench- and field-scale pilot testing is expected to be performed during the design phase, including up to four rounds of performance monitoring following the pilot test. The estimated implementation timeframe for the initial baseline groundwater monitoring event, three modified Fenton's reagent injection events, three permanganate injection events, and 14 performance monitoring events is approximately 3 years with each ISCO injection event is expected to last a few weeks to one month, and each groundwater monitoring event to last approximately one week.

During ISCO injection events, site vehicles and equipment will be temporarily stored along the Kliegman Bros. property and/or parked/staged along city streets. Access to the north parking lot will be required for implementation of the pilot test and baseline and performance groundwater monitoring activities. Access to the Kliegman Bros. property yard will be required for baseline and performance groundwater monitoring activities and implementation of the pilot test and full-scale implementation. Installation of the extraction system and construction of the treatment system on Edsall Avenue is anticipated to be completed in several weeks to one month



and will increase equipment staging along Edsall Avenue and 76<sup>th</sup> Street during system construction and installation activities. Other short-term impacts during the implementation of the field-scale pilot test and full-scale implementation are expected to be minimal.

Short-term impacts to workers and the community during this time period would be mitigated through a site-specific health and safety plan (HASP). Intrusive activities (e.g., drilling) would be performed within the limits of the source area and concentrated plume (i.e., within the 10,000 ppb [10 ppm] PCE concentration contour); however, impacts would be mitigated with personal protective equipment (PPE) and other measures under the guidance of a site-specific HASP. Additional health and safety considerations to the community would have to be addressed as drilling may be conducted on residential property/properties. The risk from the materials required for the chemical injection is limited; safety and handling and storage requirement for chemical oxidants will be included in the site-specific HASP.

### **3.7.5 Long-Term Effectiveness and Permanence**

Alternative 4 would be effective in reducing the concentrations of contaminants (e.g., PCE) in groundwater within the source area and concentrated plume area. The increased hydraulic gradient from groundwater flow to the extraction well would increase the contact area and support additional contact of the delivered oxidant with contaminant mass located below existing structures (i.e., residential properties) where surface access is limited. Concentrations of contaminants present outside the anticipated ISCO treatment and extraction capture zone would be reduced over time by dispersion. Groundwater monitoring included with this alternative would aid in the determination of the degree to which remediation is meeting remedial goals. Remediation may then be continued until monitoring results indicate an acceptable level of residual risk.

If zones of DNAPL exist (this is likely based on observed groundwater concentrations), as dissolved phase contaminant mass is treated, residual or sorbed phase DNAPL will transfer to the dissolved phase. Due to the existing dissolved phase PCE concentrations, following the first two to three ISCO applications the mass transfer of DNAPL to the dissolved phase may occur

after the delivered oxidant volume has been expended. Therefore, performance monitoring will be used to evaluate the level of overall contaminant mass removal compared to baseline PCE concentrations. Additional ISCO events will be implemented as needed based upon this evaluation of overall contaminant mass removal in comparison to site remedial goals.

RAOs for soil gas will be met with the ongoing vapor intrusion mitigation program and SVE system at the Kliegman Bros. property that will remove VOCs and reduce the exposure of VOCs in soil gas to adjacent residents.

### **3.7.6 Reduction of Toxicity, Mobility, and Volume**

Treatment utilizing ISCO within the source area and extraction and treatment of groundwater within the concentrated plume area will reduce the toxicity of contaminants present in groundwater within this area. This alternative will satisfy NYSDEC's preference for treatment. URS estimates there are about 1,100 lb of dissolved PCE in the saturated zone to the extent of contamination defined by the 10,000 µg/L isoconcentration line. This mass is likely much higher depending on the extent to which residual DNAPL is present in the saturated zone. Based on the amount of PCE removed by the SVE IRM there were tens of thousands of kilograms of PCE present in the vadose zone, suggesting the possibility of high DNAPL mass in the saturated zone as well. Because of the induced groundwater gradient, more dissolved PCE would be treated with this alternative compared to Alternatives 3A and 3B. Therefore, assuming that ISCO destroys 98% of the PCE present, approximately 25 lb of dissolved PCE would remain within the 10,000 µg/L isoconcentration line, and an additional 200 lb or so would remain dissolved in the groundwater outside this contour. The remaining PCE would not be uniformly distributed, but would be present in localized areas where oxidant had not penetrated, such as localized low permeability zones or areas unreachable due to the presence of buildings and other limitations on the injection pattern. Outside the source area, wherever the injected oxidant reaches, PCE concentrations are expected to be reduced to levels near or below the SCG value. In the source area, where residual DNAPL may be present, concentrations may be above the SCG value, even after the additional follow-on injections to address rebound.

### **3.7.7 Implementability**

Construction of the individual injection or extraction wells, groundwater treatment system, and force main are not anticipated to be difficult. The magnitude of the effort may be noticeable to the residents of the neighborhood. Given the limitations on the amount of open space available for the facilities, the active nature of the business at the Kliegman Bros. property, and the presence of numerous subsurface utilities, many considerations will have to be undertaken to locate the components of this alternative in acceptable and effective areas. Locating the injection wells in an effective and properly-spaced grid pattern will be challenging. For the groundwater extraction component, administrative issues such as traffic concerns and citing for the extraction well, force main, and groundwater treatment system housing in a residential area may make approvals difficult to obtain.

Materials and services for construction and operation would be readily available. Regulations regarding construction and operation in a residential area would prevail throughout the remediation considering that the on-site implementation (i.e., time required for installation of injection wells associated with pilot test and full-scale activities) is expected to be implemented over a short time period (i.e., about 3 years).

### **3.7.8 Cost**

The cost analysis for Alternative 4 is presented in Appendix B. Table 3-1 presents the capital cost, annual OM&M cost and total present worth of OM&M costs (based on a 5% discount rate). Although the injection events will occur over the course of 3 years, the costs for all injection events are considered capital costs. It is assumed that the extraction well and groundwater treatment system will operate for 3 years during ISCO implementation.

## **3.8 Summary**

The detailed analysis of alternatives is summarized in Table 3-3.

## **4.0 COMPARATIVE ANALYSIS OF ALTERNATIVES**

### **4.1 Overall Protection of Human Health and the Environment**

Alternatives 3A, 3B, and 4 potentially provide the greatest protection to human health by addressing the highest concentrations of the plume, with injection wells spaced across the source area (including groundwater associated with OU1) and concentrated plume (i.e., within the 10,000 ppb [10 ppm] PCE concentration contour). Alternative 4 includes the potential for increased effectiveness by enhancing the hydraulic gradient and increasing the contact (i.e., subsurface distribution) of the delivered chemical oxidants to groundwater beneath the residential buildings where direct injection is inaccessible. The enhanced hydraulic gradient included in Alternative 4 increases the ability and potential effectiveness of ISCO treatment in the highest concentration portion of the plume, thus potentially will treat the greatest amount of contaminant mass. Alternative 3B addresses the largest portion of the plume and includes injection at the source area, concentrated plume and within the expanded plume (i.e., within the 1 ppm [1,000 ppb] PCE concentration contour). Alternatives 3A, 3B, and 4 all include a minimum of four ISCO applications and provide more protection than Alternatives 2A and 2B due to the reduction in toxicity of contaminants through the ISCO process.

Alternative 1 provides limited protection. Concentrations of contaminants present within non-remediated areas of the plume would be reduced over time by dispersion. Groundwater monitoring included in all alternatives would aid in the determination of the degree to which remediation is meeting remedial goals. Remediation could then be continued until monitoring results indicated an acceptable level of residual risk.

The ongoing vapor intrusion mitigation program and the SVE system at the Kliegman Bros. property will reduce the exposure of VOCs in soil gas to adjacent residents for all alternatives.

## **4.2 Compliance with SCGs**

Because Alternative 4 uses an induced groundwater gradient to draw injected oxidants through the plume, it results in the greatest reduction in contaminant concentrations and improvement in groundwater quality. Alternatives 3A and 3B improve groundwater quality over Alternative 1, and in a more rapid time frame than Alternatives 2A and 2B. Alternatives 2A and 2B include considerations relating to groundwater discharge and air emissions SCGs and require a longer time period for remediation than Alternatives 3A, 3B, and 4.

## **4.3 Short-Term Impacts and Effectiveness**

As no construction is included with Alternative 1, it presents the shortest implementation time frame and fewest short-term impacts. Short-term impacts to workers, the community, and the environment and additional health and safety considerations for Alternatives 2A, 2B, 3A, 3B, and 4 would have to be addressed as drilling is included within the source area.

Construction for all alternatives is anticipated to be less than 1 year. ISCO for Alternatives 3A, 3B, and 4 would take place over about 3 years. The groundwater extraction and treatment for Alternative 4 would be performed during the 3 years of ISCO treatment. In contrast, groundwater extraction, treatment and monitoring for Alternatives 2A and 2B would continue over an anticipated 30-year period.

## **4.4 Long-term Effectiveness and Permanence**

Alternatives 3A, 3B and 4 would be effective in oxidizing contaminants and reducing groundwater contaminant concentrations. Alternatives 3A, 3A, and 4 would impact the source and concentrated plume areas; Alternatives 2B and 3B would impact the source area and expanded plume area. Concentrations of contaminants present outside the capture zones and treatment areas would be reduced over time by dispersion. Groundwater monitoring included with the alternatives would aid in the determination of the degree to which remediation is meeting

remedial goals. Remediation for all alternatives could then be continued until monitoring results indicated an acceptable level of residual risk.

RAOs for soil gas will be met under all alternatives with the ongoing vapor intrusion mitigation program and SVE system at the Kliegman Bros. property that will reduce the exposure of VOCs in soil gas to adjacent residents.

#### **4.5 Reduction of Toxicity, Mobility, and Volume**

All alternatives except Alternative 1 satisfy NYSDEC's preference for treatment to reduce toxicity and mobility, although to varying degrees. Alternatives 2A and 2B, and to some extent 4, reduce the mobility of contaminants in groundwater through extraction. Alternatives 3A and 3B provide a significant reduction in toxicity through PCE destruction by oxidation in the source and concentrated areas (3A), and the source, concentrated and expanded plume areas (3B). Because Alternative 3B treats a larger area, there is a greater amount of contaminant destruction. Based on the dissolved concentrations (and assuming 95% treatment), 3B would destroy about 1,200 lb of PCE while 3A would destroy about 1,000 lb. However, the relative difference would be much less if the amount of DNAPL PCE present in the source area were known. It is known that the SVE IRM removed tens of thousands of kilograms of PCE present in the vadose zone. This suggests that DNAPL PCE may be present in the saturated zone to the extent of thousands of pounds as well. Both 3A and 3B would treat this DNAPL equally effectively, reducing the significance of the estimated additional 200 lb destruction potentially achievable with 3B compared to 3A.

Alternative 4 provides the greatest potential reduction in toxicity through treatment of contaminants by incorporating ISCO in the source area and concentrated areas of the plume with an enhanced hydraulic gradient, allowing for increased subsurface distribution beneath residential structures where injection is inaccessible.

#### **4.6 Implementability**

Alternative 1 would be the easiest to implement. Alternatives 2A, 2B and 4 would be difficult to implement given the limitations of the amount of open space available for the facilities and the presence of numerous subsurface utilities which may be impacted especially during installation of the force main. Alternatives 3A, 3B, and 4 pose similar implementation challenges in implementing an injection well system in an effective and properly-spaced grid pattern within the source area and residential area. Of these, Alternative 3B poses the greatest challenge due to the increased number of injection wells. The magnitude of the effort may be noticeable to some residents of the neighborhood. Materials and services for construction and operation would be readily available for all alternatives. Regulations regarding construction and operation in a residential area would prevail throughout the remediation which is expected to be over a shorter time frame for Alternatives 3A and 3B, and a longer time period for Alternative 4, and longest time period for Alternatives 2A and 2B.

#### **4.7 Cost**

The cost analysis for all alternatives is presented in Appendix B. Table 3-1 presents the capital cost, annual OM&M cost and total present worth of OM&M costs (based on a 5% discount rate).

## **5.0 RECOMMENDED REMEDIAL ALTERNATIVE**

Alternative 1 is not recommended because while this alternative would meet RAOs for soil gas, it provides limited protection to human health and the environment, does not satisfy SCGs, and does not satisfy the RAOs for groundwater. It would leave contaminants in place in groundwater that would act as a continuing source to groundwater migrating offsite.

All alternatives are equally effective and provide protection with regard to soil vapors with the ongoing vapor intrusion mitigation program. Sub-slab depressurization systems will be installed as needed per the results of air monitoring efforts and an evaluation of the existing building conditions (e.g., positive pressure heating, ventilation and/or air conditioning systems).

Alternatives 3A, 3B, and 4 are more effective and provide more protection than Alternatives 2A and 2B due to the reduction in toxicity of contaminants from the ISCO process. Further, Alternatives 3A, 3B, and 4 improve groundwater quality in a more rapid time frame than Alternatives 2A and 2B. Therefore, Alternatives 3A, 3B, and 4 are preferred over Alternatives 2A and 2B.

Alternative 4 has the potential to be more effective than Alternatives 3A or 3B because the creation of a hydraulic gradient may increase the movement of the chemicals applied in situ and result in a greater volume of treated groundwater.

Compared to Alternatives 3A and 3B, Alternative 4 has difficulties involving short-term effectiveness and implementability. A groundwater extraction well and a force main to the proposed location of the groundwater treatment facility would require construction of the force main through the residential neighborhood. Also, there are limited locations for the proposed treatment facility.

Alternatives 3A, 3B and 4 all provide remediation within the source and concentrated plume areas. Alternative 3B additionally provides remediation within the remaining plume area.



Concentrations of contaminants outside the treatment zones for each alternative would be reduced over time by dispersion. Alternative 3B treats a larger area than Alternatives 3A or 4, and there would therefore be a greater amount of contaminant destruction. Based on the dissolved concentrations (and assuming 95% treatment), 3B would destroy about 1,200 pounds of PCE currently in the groundwater while 3A would destroy about 1,000 pounds. However, the majority of the contaminant mass resides in the source and concentrated plume areas, areas that would be addressed by Alternatives 3A and 4. It is known that the SVE IRM has removed tens of thousands of pounds of PCE present in the vadose zone. This suggests that nonaqueous phase PCE may be present in the saturated zone to the extent of thousands of pounds as well. Both 3A and 3B would treat this source area equally effectively, reducing the significance of the estimated additional 200-pound destruction potentially achievable with 3B compared to 3A.

The additional injections proposed in Alternative 3B provide limited overall benefit due to the lower concentrations present outside the source and concentrated plume areas. The additional injection area included in Alternative 3B increases impacts to the community during construction and ISCO implementation due to the increased number of injection wells distributed throughout the residential neighborhood. This results in much larger short-term impacts when compared to Alternative 3A.

The cost analysis for all alternatives is presented in Table 3-1, which details the capital cost, annual OM&M cost and total present worth of OM&M costs for each alternative (based on a 5% discount rate). With the exception of Alternative 3B, the costs of the alternatives that meet the threshold criteria do not vary greatly. Alternative 2A and Alternative 2B have similar costs, and Alternative 3A and 4 are somewhat more expensive. Alternative 3B is significantly more expensive than any other alternative.

On the basis of the rationale outlined in this section, In Situ Chemical Oxidation Treatment of the Concentrated Plume Area with Induced Groundwater Gradient (Alternative 4) is recommended. However, as detailed above, the density of the surrounding land use may ultimately cause installation of the extraction well, force main, and treatment facility included in Alternative 4 to be infeasible. If this is the case, then NYSDEC may elect to implement

Alternative 3A - In Situ Chemical Oxidation Treatment of the Concentrated Plume Area. The feasibility determination will be made during the remedial design process.

The estimated present worth cost to implement Alternative 4 is \$ 7,600,000. The cost to construct the remedy is estimated to be \$ 7,300,000, the estimated average annual costs for system operation (three years total) is \$21,000, and the estimated average annual costs for monitoring (five years total) is \$43,000. Note the groundwater extraction and treatment costs for Alt. 4 are considered a capital cost since they would be of a short duration compared to a long term pump and treat approach. The present worth estimate includes sampling and construction costs associated with the ongoing vapor mitigation program.

The estimated present worth cost to implement Alternative 3A is \$ 8,000,000. The cost to construct the remedy is estimated to be \$ 7,700,000, the estimated average annual costs for system operation (three years total) is \$21,000, and the estimated average annual costs for monitoring (five years total) is \$43,000. The present worth estimate includes sampling and construction costs associated with the ongoing vapor mitigation program.

# **TABLES**

**TABLE 1-1  
SUMMARY OF PCE CONCENTRATIONS (ppb) IN GROUNDWATER SAMPLES**

	2001	October 2002	April 2003	December 2003	June 2005
MW-01		2,600	NS	NS	5,300
MW-01S		1,100	610	NS	320
MW-02D		9,500	15,000	NS	2,600
MW-03D		25,000	22,000	NS	43,000
MW-04D		49,000	69,000	45,000	75,000
MW-05D		17,000	15,000	15,000	31,000
MW-06S		NS	260	NS	200
MW-07D		2,700	1,100	NS	1,200
MW-08S		ND	6	NS	ND
MW-09S		ND	1	NS	ND
MW-10D			55,000	NS	NS
MW-11D			3,500	5,900	920
MW-14D			75,000	74,000	40,000
MW-15D			400	NS	310
MW-16D			350	NS	350
MW-17D					8,400
MW-18D					5,700
MW-19D					2,300
MW-20D					370
MW-21D					300
MW-22D					190
MW-23D					3,400
MW-24D					21,000
MW-10H			180 @ ~100' 24,800 @ 72' 75 @ 88' 11 @ 103' 540 @ 118' ND @ 132' 16 @ 148'		NS NS @ ~100'
MW-12H			240 @ ~100' 51,200 @ 72' 3,790 @ 88' 51 @ 108' 16 @ 118'		ND @ ~100'
MW-13H			4 @ ~100' 809 @ 72' ND @ 88' 1 @ 102'		ND @ ~100'
SVE2	45,000 @ 70' 2,200 @ 96'				
SVE3	30,000 @ 70' 2,800 @ 96'				
SVE4	1,200 @ 70' 1,200 @ 96'				
SVE5	22,000 @ 14'				

**NS – Not Sampled      ND – Not Detected**

**TABLE 2-1  
TECHNOLOGY SCREENING SUMMARY  
KLIEGMAN BROTHERS SITE OU2  
QUEENS COUNTY, NEW YORK**

MEDIA	GENERAL RESPONSE ACTION	REMEDIAL TECHNOLOGY TYPE	PROCESS OPTION	EFFECTIVENESS	IMPLEMENTABILITY	RELATIVE COST	RETAINED
All Media	No Additional Action	Continue with IRM	SVE within property	Effective	Already implemented	Low	NA
		Implement OU1 ROD remediation	Additional SVE wells and treatment system	Effective	Readily implementable	Low – Moderate	NA
		Ongoing vapor intrusion mitigation program	Sub-slab depressurization at individual residences	Effective	Already implemented	Low	NA
Soil Gas	Exposure Point Mitigation	Vapor intrusion mitigation unit	Sub-slab depressurization at individual residences	Effective	Readily implementable	Low	Y
Groundwater	Containment	Vertical Cutoff Walls	Downgradient slurry walls, grout curtains, sheet pile, geomembranes	Effective	Difficult due to depth and areal extent of plume	Moderate - High	N
		Permeable Reactor Barrier Wall	Vertical wall downgradient of plume reacts with containments	Potentially effective for PCE	Difficult due to depth, areal extent of plume, and lack of hydraulic gradient	Moderate - High	N
		Hydraulic Controls	Downgradient collection trench	Potentially effective	Difficult due to depth and areal extent of plume	High	N
			Injection Wells - vertical injection of clean water into upgradient wells	Injection of unamended water may create radial and/or downward contaminant migration; amended water combined with in situ treatment may be effective	Implementable but location(s) must minimize impacts to residences	Low – Moderate	Y
			Extraction Wells - vertical extraction wells within plume	Effective when combined with groundwater treatment	Implementable, but location(s) must minimize impacts to residences. Must be combined with groundwater treatment	Low - Moderate	Y
	Treatment	Above-Ground Treatment	Treatment facility designed and constructed for this site	A facility designed specifically for site contaminants and flow rate would be effective.	Space limitations and flow rate make implementation difficult	Moderate – High	Y
			Off-site treatment facility	Effective at an appropriate facility	Flow rate may limit the number of facilities willing to accept extracted water	High	N
		In-well Treatment System	Reactor utilizing catalytic reductive dehalogenation within extraction well	Effective on PCE at low flow rates	Implementable with space limitation considerations	Moderate	N
		In Situ Biological Treatment	Reductive dechlorination	Unknown effectiveness on PCE concentrations	Implementable with space limitation considerations	Moderate – High	N
		In Situ Chemical Treatment	Modified Fenton's reagent	Potentially effective	Implementable with space limitation considerations	Moderate	Y
			Permanganate	Potentially effective	Implementable with space limitation considerations	Moderate	Y
			Ozone	Potentially effective	Implementable with space limitation considerations	Moderate	N
			Persulfate	Potentially effective	Implementable with space limitation considerations	Moderate	N
		In Situ Physical/Thermal Treatment	Air Sparging	Effective when combined with SVE	Difficult to implement due to space limitations	High	N

NA - Not Applicable

**Table 3-1**

**SUMMARY OF ESTIMATED COSTS  
KLIEGMAN BROTHERS OU2**

<u>Cost Component</u>	<u>Alternative 1</u>	<u>Alternative 2A</u>	<u>Alternative 2B</u>	<u>Alternative 3A</u>	<u>Alternative 3B</u>	<u>Alternative 4</u>
<b><u>Capital Costs</u></b>						
Capital Costs	\$0	\$1,218,000	\$1,062,000	\$7,690,000	\$13,658,000	\$7,272,000
<b><u>Annual OM&amp;M Costs</u></b>						
Annual System Operation Cost	\$21,000	\$283,000	\$296,000	\$21,000	\$21,000	\$21,000
Annual Monitoring Cost	\$10,000	\$43,000	\$43,000	\$43,000	\$43,000	\$43,000
<b><u>Present Worth OM&amp;M Costs</u></b>						
Present Worth System Operation Cost	\$323,000	\$4,354,000	\$4,527,500	\$93,200	\$93,200	\$94,400
Present Worth Annual Monitoring Cost	\$154,000	\$667,000	\$688,000	\$189,000	\$189,000	\$190,000
Present Worth OM&M Cost	\$477,000	\$5,021,000	\$5,215,500	\$282,200	\$282,200	\$284,400
Years of System Operation	30	30	30	3	3	3
Years of Monitoring	30	30	30	5	5	5
<b><u>Total Present Worth Cost</u></b>	<b>\$477,000</b>	<b>\$6,239,000</b>	<b>\$6,278,000</b>	<b>\$7,972,000</b>	<b>\$13,940,000</b>	<b>\$7,557,000</b>

Notes:

- 1) 2A/2B: 30 years of operation with 6 cycles each 3 years of groundwater pump and treat followed by 2 years no pump and treat
- 2) 5% discount rate used to determine Present Worth
- 3) The alternatives are as follows:

Alternative 1 - No Additional Action

Alternative 2A - Groundwater Extraction from Concentrated Plume Area with Above-Ground Water Treatment

Alternative 2B - Groundwater Extraction from Entire Plume Area with Above-Ground Water Treatment

Alternative 3A - In Situ Chemical Oxidation Treatment of Concentrated Plume Area

Alternative 3B - In Situ Chemical Oxidation Treatment of Entire Plume Area

Alternative 4 - In Situ Chemical Oxidation Treatment of Concentrated Plume Area with Induced Groundwater Gradient

**TABLE 3-2**  
**KLIEGMAN BROTHERS FS**  
**SUMMARY OF AIR STRIPPING REQUIREMENTS**

<b>Water Flow Rate (gpm)</b>	<b>Air Flow Rate Without MTBE Treatment (scfm)</b>	<b>Air Flow Rate With MTBE Treatment (scfm)</b>
150	1800	1800
300	2400	3600

NOTE: This table is representative of the modeling provided by one particular vendor of air stripping equipment. Other manufacturers may indicate different results. Modeling is based on the latest results for monitoring well location MW-24D.

**TABLE 3-3  
EVALUATION OF ALTERNATIVES**

<b>CRITERIA</b>	<b>Alternative 1: No Additional Action</b>	<b>Alternative 2A: Groundwater Extraction from Concentrated Plume Area with Above-Ground Water Treatment</b>	<b>Alternative 2B: Groundwater Extraction from Entire Plume Area with Above- Ground Water Treatment</b>	<b>Alternative 3A: In Situ Chemical Oxidation Treatment of Concentrated Plume Area</b>	<b>Alternative 3B: In Situ Chemical Oxidation Treatment of Entire Plume Area</b>	<b>Alternative 4: In Situ Chemical Oxidation Treatment of Concentrated Plume Area with Induced Ground- water Gradient</b>
<b>OVERALL PROTECTIVENESS</b>						
Protect Human Health and Environment	No reduction in contamination of soil or groundwater. SVI mitigation activities reduce exposure from vapors.	Most contaminated portion of GW plume treated over time. SVI mitigation activities reduce exposure from vapors.	Most of GW plume treated over time. SVI mitigation activities reduce exposure from vapors.	Most contaminated portion of GW plume treated. SVI mitigation activities reduce exposure from vapors.	Most of GW plume treated. SVI mitigation activities reduce exposure from vapors.	Most contaminated portion of GW plume treated. SVI mitigation activities reduce exposure from vapors.
<b>COMPLIANCE WITH SCGS</b>						
Soil and Groundwater Cleanup Criteria	Does not meet groundwater SCGs.	PCE in groundwater within treatment area gradually decreases towards SCGs.	PCE in groundwater within treatment area gradually decreases towards SCGs.	PCE in groundwater within treatment area decreases towards SCGs.	PCE in groundwater within treatment area decreases towards SCGs.	PCE in groundwater within treatment area decreases towards SCGs.
<b>SHORT-TERM IMPACTS AND EFFECTIVENESS</b>						
Community and Worker Protection	No impacts to community or workers.	Health and safety measures during implementation would be protective against short-term risks from volatiles.	Health and safety measures during implementation would be protective against short-term risks from volatiles.	Health and safety measures during implementation would be protective against short-term risks from volatiles and from oxidation agents.	Health and safety measures during implementation would be protective against short-term risks from volatiles and from oxidation agents.	Health and safety measures during implementation would be protective against short-term risks from volatiles and from oxidation agents.



**TABLE 3-3 (Continued)**

<b>CRITERIA</b>	<b>Alternative 1: No Additional Action</b>	<b>Alternative 2A: Groundwater Extraction from Concentrated Plume Area with Above-Ground Water Treatment</b>	<b>Alternative 2B: Groundwater Extraction from Entire Plume Area with Above- Ground Water Treatment</b>	<b>Alternative 3A: In Situ Chemical Oxidation Treatment of Concentrated Plume Area</b>	<b>Alternative 3B: In Situ Chemical Oxidation Treatment of Entire Plume Area</b>	<b>Alternative 4: In Situ Chemical Oxidation Treatment of Concentrated Plume Area with Induced Ground- water Gradient</b>
Environmental Impacts	Current conditions continue to exist.	Contaminant levels in groundwater reduced.	Contaminant levels in groundwater reduced.	Contaminant levels in groundwater reduced.	Contaminant levels in groundwater reduced.	Contaminant levels in groundwater reduced.
Time Until Action is Complete	Not applicable.	Remediation will continue for decades.	Remediation will continue for decades.	Oxidation to require about three years. Monitoring of downgradient plume to continue for decades.	Oxidation to require about three years. Monitoring of downgradient plume to continue for decades.	Oxidation to require about three years. Monitoring of downgradient plume to continue for decades.
<b>LONG-TERM EFFECTIVENESS AND PERMANENCE</b>						
Magnitude of Residual Risk	Remains at current levels. Vapor exposure risks mitigated with SSD systems.	Groundwater to remain above 1 mg/L outside of treatment area, but no current groundwater use. Vapor exposure risks mitigated with SSD systems.	Groundwater to remain below 1 mg/L outside of treatment area, but no current groundwater use. Vapor exposure risks mitigated with SSD systems.	Groundwater to remain above 1 mg/L outside of treatment area, but no current groundwater use. Vapor exposure risks mitigated with SSD systems.	Groundwater to remain below 1 mg/L outside of treatment area, but no current groundwater use. Vapor exposure risks mitigated with SSD systems.	Groundwater to remain above 1 mg/L outside of treatment area, but no current groundwater use. Vapor exposure risks mitigated with SSD systems.
Adequacy and Reliability of Controls	SSD systems subject to OM&M program.	Periodic sampling of groundwater. SSD systems subject to OM&M program.	Periodic sampling of groundwater. SSD systems subject to OM&M program.	Periodic sampling of groundwater. SSD systems subject to OM&M program.	Periodic sampling of groundwater. SSD systems subject to OM&M program.	Periodic sampling of groundwater. SSD systems subject to OM&M program.

**TABLE 3-3 (Continued)**

<b>CRITERIA</b>	<b>Alternative 1: No Additional Action</b>	<b>Alternative 2A: Groundwater Extraction from Concentrated Plume Area with Above-Ground Water Treatment</b>	<b>Alternative 2B: Groundwater Extraction from Entire Plume Area with Above- Ground Water Treatment</b>	<b>Alternative 3A: In Situ Chemical Oxidation Treatment of Concentrated Plume Area</b>	<b>Alternative 3B: In Situ Chemical Oxidation Treatment of Entire Plume Area</b>	<b>Alternative 4: In Situ Chemical Oxidation Treatment of Concentrated Plume Area with Induced Ground- water Gradient</b>
<b>REDUCTION OF TOXICITY, MOBILITY, OR VOLUME (TMV)</b>						
Treatment Process(es) Used	None	Groundwater contamination treated with above-ground treatment such as air stripping	Groundwater contamination treated with above-ground treatment such as air stripping	Groundwater and soil contamination treated in situ by oxidation.	Groundwater and soil contamination treated in situ by oxidation.	Groundwater and soil contamination treated in situ by oxidation. Extracted groundwater treated with above-ground treatment.
Reduction of TMV by Treatment	None	Treatment reduces VOC toxicity and reduces migration.	Treatment reduces VOC toxicity and reduces migration.	Treatment reduces VOC toxicity through destruction.	Treatment reduces VOC toxicity through destruction.	Treatment reduces VOC toxicity through destruction and reduces migration.
Types and Quantity of Residuals Remaining After Treatment	NA	No residuals after regeneration of vapor phase carbon. Untreated down-gradient plume on order of 90 kg PCE remains.	No residuals after regeneration of vapor phase carbon. Magnitude of untreated residual downgradient plume contaminants lower than Alt 2A.	Some limited residuals will remain in zone that is treated due to DNAPL on order of 25 kg PCE. Untreated down-gradient plume on order of 90 kg PCE remains.	Some limited residuals, on order of 30 kg PCE will remain in zone that is treated due to DNAPL. Magnitude of untreated residual downgradient plume contaminants lower than Alt 3A.	Some limited residuals, on order of 10 kg PCE, will remain in zone that is treated due to DNAPL. Untreated downgradient plume on order of 90 kg PCE remains.

**TABLE 3-3 (Continued)**

<b>CRITERIA</b>	<b>Alternative 1: No Additional Action</b>	<b>Alternative 2A: Groundwater Extraction from Concentrated Plume Area with Above-Ground Water Treatment</b>	<b>Alternative 2B: Groundwater Extraction from Entire Plume Area with Above- Ground Water Treatment</b>	<b>Alternative 3A: In Situ Chemical Oxidation Treatment of Concentrated Plume Area</b>	<b>Alternative 3B: In Situ Chemical Oxidation Treatment of Entire Plume Area</b>	<b>Alternative 4: In Situ Chemical Oxidation Treatment of Concentrated Plume Area with Induced Ground- water Gradient</b>
Statutory Preference For Treatment	Does not satisfy.	Satisfies preference for treatment.	Satisfies preference for treatment.	Satisfies preference for treatment.	Satisfies preference for treatment.	Satisfies preference for treatment.
<b>IMPLEMENTABILITY</b>						
Ability to Construct and Operate	SSD systems readily constructible.	Dearth of available space for treatment limits implementability. SSD systems readily constructible.	Dearth of available space for treatment limits implementability. SSD systems readily constructible.	Access to streets required for oxidant injection. SSD systems readily constructible.	Access to streets required for oxidant injection. SSD systems readily constructible.	Access to streets required for oxidant injection. Dearth of available space for treatment limits implementability. SSD systems readily constructible.
Ease of Undertaking Additional Action if Needed	NA	Duration of treatment is open-ended.	Duration of treatment is open-ended.	Injection wells installed for oxidation will remain in place allowing additional injections if necessary.	Injection wells installed for oxidation will remain in place allowing additional injections if necessary.	Injection wells installed for oxidation will remain in place allowing additional injections if necessary.
Ability to Monitor Effectiveness	SSD systems subject to OM&M program.	Groundwater monitoring readily implemented.	Groundwater monitoring readily implemented.	Groundwater monitoring readily implemented.	Groundwater monitoring readily implemented.	Groundwater monitoring readily implemented.

**TABLE 3-3 (Continued)**

<b>CRITERIA</b>	<b>Alternative 1: No Additional Action</b>	<b>Alternative 2A: Groundwater Extraction from Concentrated Plume Area with Above-Ground Water Treatment</b>	<b>Alternative 2B: Groundwater Extraction from Entire Plume Area with Above- Ground Water Treatment</b>	<b>Alternative 3A: In Situ Chemical Oxidation Treatment of Concentrated Plume Area</b>	<b>Alternative 3B: In Situ Chemical Oxidation Treatment of Entire Plume Area</b>	<b>Alternative 4: In Situ Chemical Oxidation Treatment of Concentrated Plume Area with Induced Ground- water Gradient</b>
Ability to Obtain Approvals and Coordinate with Other Agencies	NA	Need to obtain discharge permit with NYSDEP. Street opening permits required.	Need to obtain discharge permit with NYSDEP. Street opening permits required.	Street opening permits required.	Street opening permits required.	Need to obtain discharge permit with NYSDEP. Street opening permits required.
Availability of Equipment, Specialists and Materials	SSD system installers readily available.	Mitigation and Remediation contractors readily available.	Mitigation and Remediation contractors readily available.	Mitigation and Remediation contractors readily available.	Mitigation and Remediation contractors readily available.	Mitigation and Remediation contractors readily available.
<b>CAPITAL COST</b>	<b>\$0</b>	<b>\$1,218,000</b>	<b>\$1,062,000</b>	<b>\$7,690,000</b>	<b>\$13,658,000</b>	<b>\$7,272,000</b>
<b>Total Present Worth</b>	<b>\$477,000</b>	<b>\$6,239,000</b>	<b>\$6,148,000</b>	<b>\$7,972,000</b>	<b>\$13,940,000</b>	<b>\$7,557,000</b>

## **FIGURES**

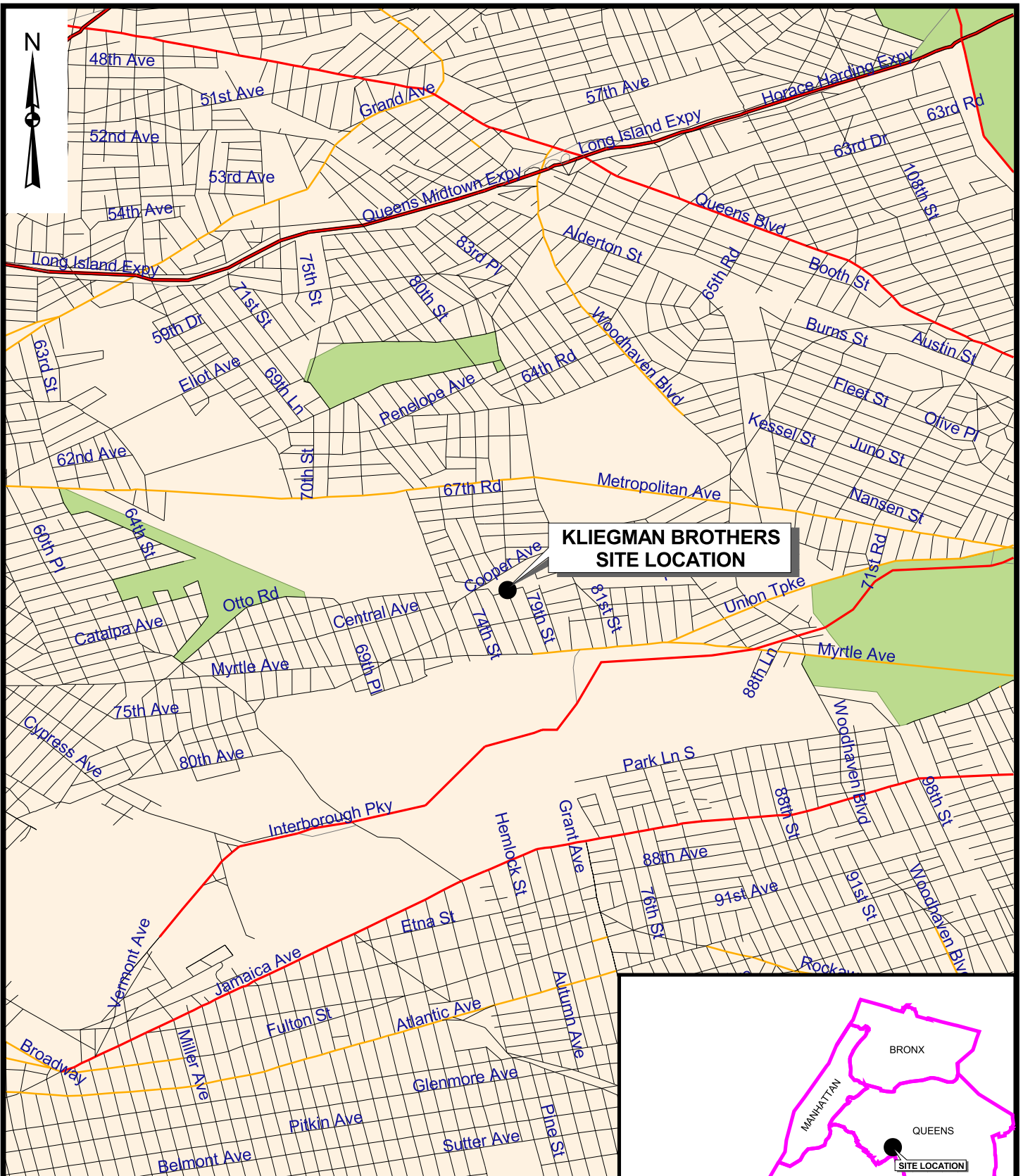

N:\1171964\000001\BIGIS\site.apr SITE LOCATION  
10/7/2005



KIEGMAN BROTHERS  
SITE LOCATION MAP

FIGURE 1-1





N:\11171964\000000\GIS\ArcMap\SITE\_PLAN.mxd Date: 07/26/2006

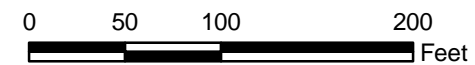

KLEGMAN BROTHERS  
SITE PLAN



FIGURE 1-2

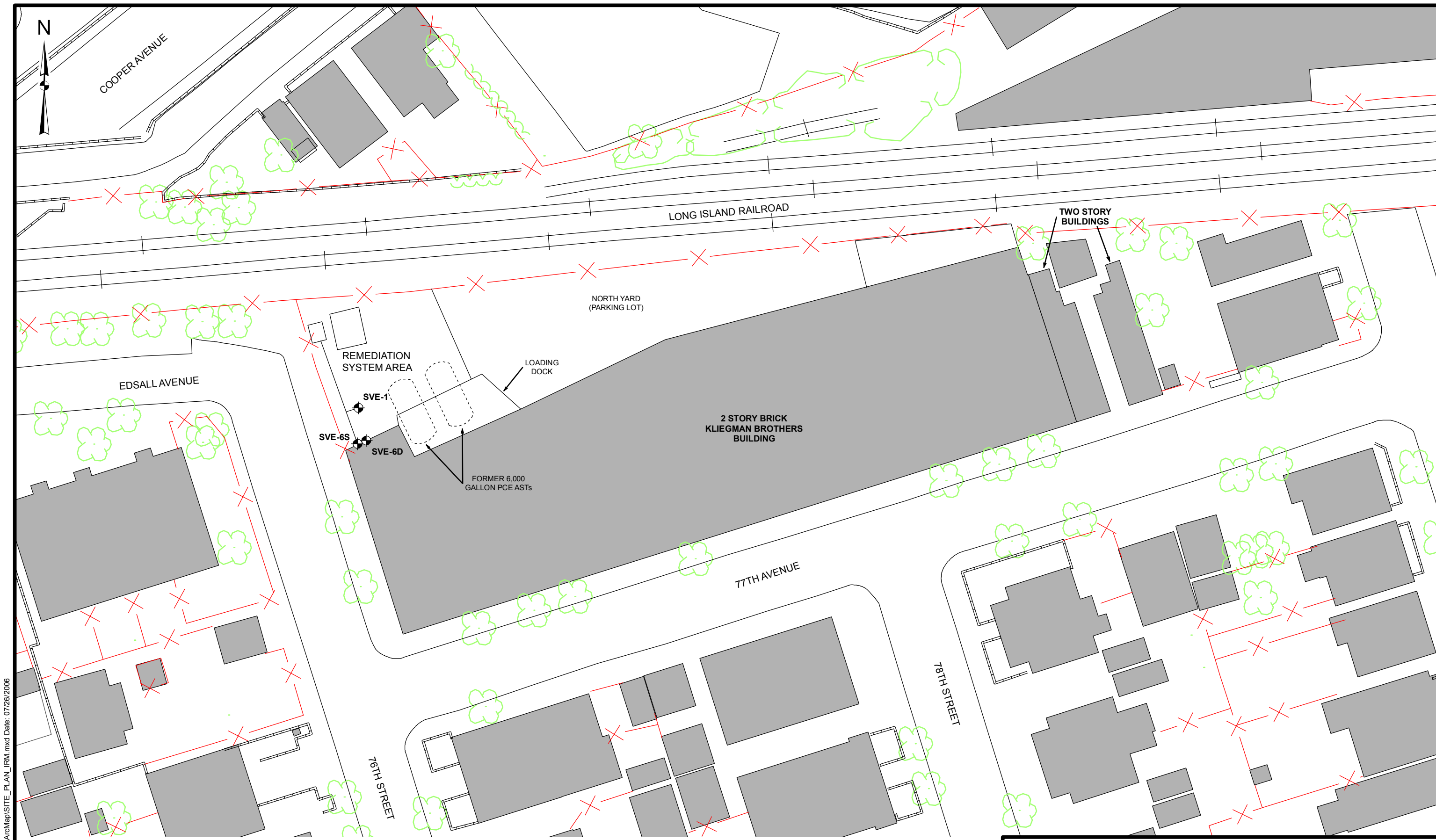

COOPER AVENUE

LONG ISLAND RAILROAD

EDSALL AVENUE

REMEDIATION SYSTEM AREA

LOADING DOCK

NORTH YARD (PARKING LOT)

SVE-1

SVE-6S

SVE-6D

FORMER 6,000 GALLON PCE ASTs

2 STORY BRICK KIEGMAN BROTHERS BUILDING

TWO STORY BUILDINGS

77TH AVENUE

76TH STREET

78TH STREET

**Legend**

⊕ Soil Vapor Extraction Well Location

NOTES:  
S - Indicates Shallow Well  
D - Indicates Deep Well

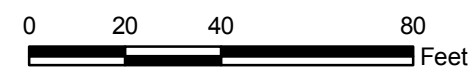

**KIEGMAN BROTHERS  
IRM SITE PLAN**



FIGURE 1-3

N:\1171964\000000\GIS\MapSite\_PLAN\_IRM.mxd Date: 07/26/2006





**Legend**

- ◆ Sampling Location and Soil Vapor Extraction Well Location
- ⊕ Monitoring Well Location
- 1,000 — Tetrachloroethene Isoconcentration Contour

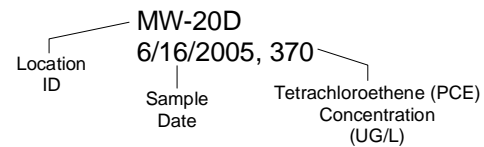

NOTES:  
NS - Not Sampled  
ND - Not Detected

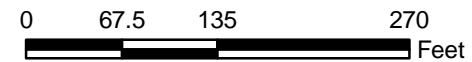

**KLIEGMAN BROTHERS  
PCE CONCENTRATIONS IN SHALLOW GROUNDWATER**



FIGURE 1-4





**SVE-2**  
6/1/2001, 2,200  
6/2005, NS

**MW-10H**  
4/30/2003, 180  
6/2005, NS

**SVE-4**  
6/1/2001, 1,200  
6/2005, NS

**MW-13H**  
4/29/2003, 4  
6/16/2005, ND

**SVE-3**  
6/1/2001, 2,800  
6/2005, NS

**MW-12H**  
4/29/2003, 240  
6/16/2005, ND

**Legend**

- ◆ Sampling Location and Soil Vapor Extraction Well Location
- ⊕ Monitoring Well Location

MW-12H  
4/29/2003, 240

Location ID      Sample Date      Tetrachloroethene (PCE) Concentration (UG/L)

NOTES:  
NS - Not Sampled  
ND - Not Detected

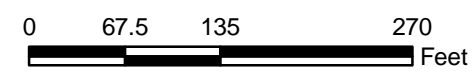

**KLIEGMAN BROTHERS  
PCE CONCENTRATIONS IN DEEP GROUNDWATER**



FIGURE 1-5

N:\1171964\000000\GIS\ArcMap\ChemicalPCE\_DeepGW.mxd Date: 08/01/2006

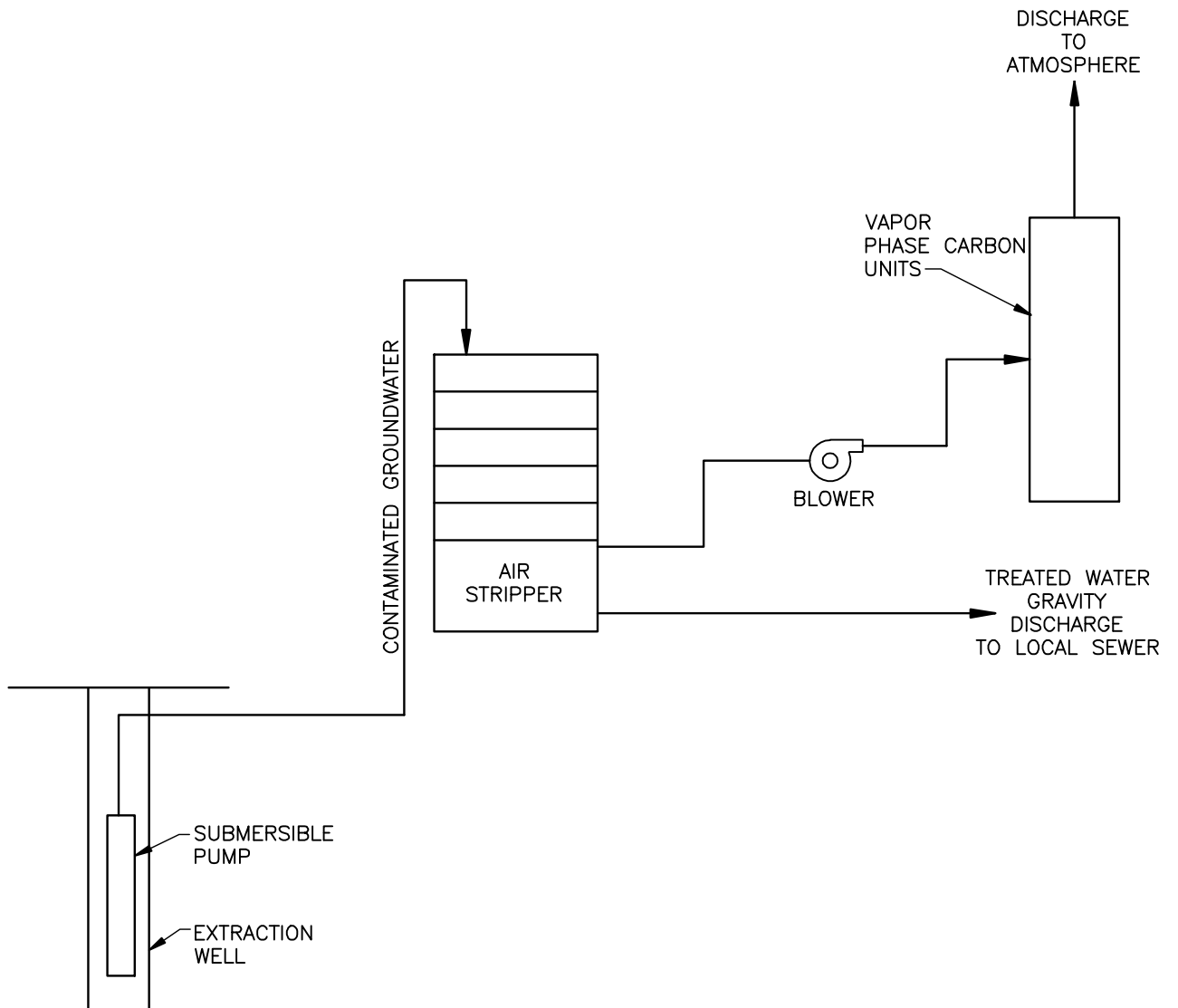





**Legend**

- ◆ OUI Soil Vapor Extraction Well Location
- Monitoring Well Location for Long Term Sampling & Analysis
- ⊕ Soil Vapor Extraction Well Location Currently in Use for IRM
- - - Proposed Underground Pipe
- - - 1,000 Tetrachloroethene Isoconcentration Contour

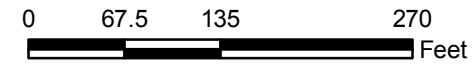

KLIEGMAN BROTHERS  
LAYOUT FOR ALTERNATIVE 1



FIGURE 3-1





**Legend**

- Proposed Extraction Well Alternative 2A
- Monitoring Well Location for Long Term Sampling & Analysis
- ⊕ Soil Vapor Extraction Well Location Currently in Use for IRM
- Proposed Force Main
- - - 1,000 Tetrachloroethene Isoconcentration Contour
- - - 10,000 Tetrachloroethene Isoconcentration Contour

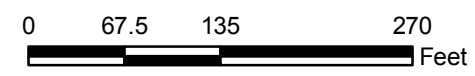

KLIEGMAN BROTHERS  
CONCEPTUAL LAYOUT FOR ALTERNATIVE 2A



FIGURE 3-2

N:\11171964\000000\GIS\Map\ALTERNATIVE\_2A.mxd Date: 10/26/2006





**Legend**

- Proposed Extraction Well Alternative 2B
- Monitoring Well Location for Long Term Sampling & Analysis
- ⊕ Soil Vapor Extraction Well Location Currently in Use for IRM
- Proposed Force Main
- - - 1,000 Tetrachloroethene Isoconcentration Contour

Proposed Extraction Wells Alternative 2B

Proposed Treatment Facility for Alternatives 2A & 2B

PROPERTY BOUNDARY

FORMER 6,000 GALLON PCE ASTs

SCHOOL 119

SCHOOL 119

KLIEGMAN BROTHERS  
CONCEPTUAL LAYOUT FOR ALTERNATIVE 2B







FIGURE 3-3

N:\11171964\000000\GIS\Map\ALTERNATIVE\_2B.mxd Date: 10/26/2006





**Legend**

-  Proposed Injection Well Location  
30-Foot Spacing
-  Monitoring Well Location for  
Long Term Sampling & Analysis
-  Soil Vapor Extraction Well  
Location Currently in Use for IRM
-  1,000 Tetrachloroethene  
Isoconcentration Contour

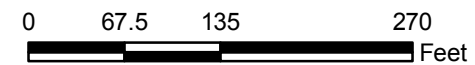

KLIEGMAN BROTHERS  
CONCEPTUAL LAYOUT FOR ALTERNATIVE 3A







FIGURE 3-4





**Legend**

-  Proposed Injection Well Location  
30-Foot Spacing
-  Proposed Injection Well Location  
60-Foot Spacing
-  Monitoring Well Location for  
Long Term Sampling & Analysis
-  Soil Vapor Extraction Well  
Location Currently in Use for IRM
-  1,000 Tetrachloroethene  
Isoconcentration Contour

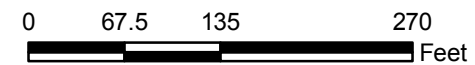

KLEGMAN BROTHERS  
CONCEPTUAL LAYOUT FOR ALTERNATIVE 3B









FIGURE 3-5





**Legend**

-  Proposed Injection Well Location
-  Proposed Extraction Well Alternative 4
-  Monitoring Well Location for Long Term Sampling & Analysis
-  Sampling Location and Soil Vapor Extraction Well Location
-  Proposed Force Main
-  1,000 Tetrachloroethene Isoconcentration Contour
-  10,000 Tetrachloroethene Isoconcentration Contour

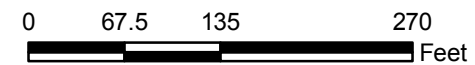

KLIEGMAN BROTHERS  
CONCEPTUAL LAYOUT FOR ALTERNATIVE 4



FIGURE 3-6

# **APPENDICES**

**APPENDIX A**  
**GROUNDWATER CALCULATIONS**

**CALCULATION COVER SHEET**

Client: NYSDEC Project Name: Kliegman Bros

Project / Calculation Number: 111 74 770

Title: Hydraulic Containment of the Dissolved-Phase PCE Contamination - Part I

Total number of pages (including cover sheet): 36 (35 + cover)

Total number of computer runs: 0

Prepared by: Marek Ostrowski

Date: Sep 21, 2006

Checked by: Amy Monti

Date: Sep 22, 2006

Description and Purpose: To evaluate the feasibility of controlling the dissolved-phase contamination by means of hydraulic containment. Following parameters are discussed:  
\* Number of extraction wells, \* Well locations, \* Well penetration depth,  
\* Well diameter, \* Extraction rate.

Design bases / references / assumptions: Theory of wells in uniform flow is used. Aquifer thickness and hydraulic conductivity estimated based on literature sources. Local hydraulic gradient is not well defined, the regional value is used.

Remarks / conclusions: See Section 7 SUMMARY for details. Containment appears to be feasible. For wells placed at Kliegman property, rates of 1,000 and 2,000 gpm would be required for the 10,000-ppb and 1,000-ppb plumes, respectively. This could be reduced to 100 and 200 gpm (10,000-ppb and 1,000-ppb plumes, respectively) if wells were placed near downgradient edges of plumes. Uncertainties exist regarding magnitude and direction of hydraulic gradient, aquifer thickness and hydraulic conductivity.

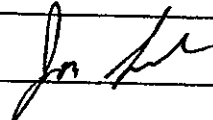
Calculation Approved by:  10/2/06  
Project Manager / Date

Revision No: Description of Revisions Approved by:  
\_\_\_\_\_  
\_\_\_\_\_  
\_\_\_\_\_ Project Manager / Date

URS

PAGE 1 OF 35

JOB NO. 111 74 770

MADE BY: *mo* DATE: *8/21/06*  
CHKD. BY: *AMM* DATE: *9/22/06*

PROJECT: NYSDEC, Kliegman Bros. Site

SUBJECT: Hydraulic Containment of the Dissolved-Phase PCE Contamination - Part 1

## 1. PURPOSE

The purpose of this calculation is to investigate the feasibility of using hydraulic containment to control dissolved PCE contamination identified at the Kliegman Brothers site. Two plumes are considered, with boundaries defined by the 1,000-ppb and 10,000-ppb isoconcentration lines, respectively. The following issues are discussed:

- Number of extraction wells
- Well locations
- Well penetration depth
- Well diameter
- Extraction rate

## 2. GENERAL

Information about the site is based on reference 1. The site is located in the City of New York, Queens County, in a densely populated urban/commercial setting (Figure 1-1 of this FS report, reproduced on page 14). The upper-most unit is the unconfined Upper Glacial aquifer, with the water table located approximately 70 feet below ground surface, although a perched water zone has been identified approximately 10 to 15 feet below ground surface in the eastern part of the site. The overall thickness of the water-bearing zone is not known. Wells were drilled to the maximum depth of approximately 150 ft. Hydraulic conductivity of the water-bearing zone deposits, as measured using slug tests, is very high, on the order of  $10^{-2}$  to  $10^{-1}$  cm/s. In the perched zone, the hydraulic conductivity appears to be much lower. The hydraulic gradient in the water-bearing zone is very low, to the point where the identification of the local flow direction across the site is not feasible with existing data.

A plume of dissolved contamination has been identified. The extent of the plume of PCE is shown on Figure 1-4 of this FS report, also reproduced page 15 of this calculation. There is an area of approximately 400 by 600 ft, where concentrations of PCE area greater than 10,000 micrograms per liter. The area with concentrations greater than 1,000 micrograms per liter is approximately 800 by 1,200 ft. Note that the 1,000-ppb area is well defined only to the west.

MADE BY: *hw*DATE: *8/21/06*CHKD. BY: *AmM*DATE: *9/22/06*

PROJECT: NYSDEC, Kliegman Bros. Site

SUBJECT: Hydraulic Containment of the Dissolved-Phase PCE Contamination - Part 1

Because of the low hydraulic gradients, it is difficult to determine the local flow direction. The shape of the plume - elongated in the north-south direction - appears to indicate the southerly flow. Also, the regional flow direction is to the south (reference 2).

### 3. METHODOLOGY

Ground water flowing through the designated containment area is to be captured by means of ground water extraction wells. The total extraction rate required to create a capture zone around that area will be calculated using the approximation of a well placed in the uniform flow of ground water. Terms used in this methodology are listed below in alphabetical order:

- d - Downgradient extent of the capture zone, [m]
- $H_0$  - Undisturbed saturated thickness, [m]
- $h_w$  - Saturated thickness at well face, [m]
- i - Hydraulic gradient, [-]
- K - Hydraulic conductivity, [m/s]
- Q - Required total extraction rate, [m<sup>3</sup>/s]
- $Q_w$  - Extraction rate of a single well, [m<sup>3</sup>/s]
- R - Well's radius of influence, [m]
- $r_w$  - Radius of the well, [m]
- $s_w$  - Drawdown in the well, [m]
- T - Aquifer's transmissivity, [m<sup>2</sup>/s]
- W - Width of the capture zone in the direction perpendicular to the flow, at the line passing through the well, [m]

The lateral extent of the capture at the line passing through the well can be estimated as (reference 3, Figure 12):

$$W = Q_w / 2 T i$$

The downgradient extent of the capture zone of a single well, at the line parallel to the flow and passing through the well, can be calculated as (reference 3, Figure 12):

$$d = Q_w / 2\pi T i$$

MADE BY: *mo*DATE: *9/21/06*CHKD. BY: *AMM*DATE: *9/22/06*

PROJECT: NYSDEC, Kliegman Bros. Site

SUBJECT: Hydraulic Containment of the Dissolved-Phase PCE Contamination - Part 1

The lateral and sidegradient dimensions ("W" and "d", respectively) of the capture zone of a single well can be compared to the dimensions of capture zone required to achieve the containment of the plume. When the size of the capture zone of a single well is not sufficient, several wells must be used.

Note that the overall sidegradient dimension of the capture zone of a system of wells ( $W_{total}$ ) is a linear function of the total extraction rate; and therefore, the linear function of the number "N" of wells in operation (reference 3, Table 5).

$$W_{total} = N W = N (Q_w / 2 T i)$$

Therefore, knowing the required total width of the capture zone, the necessary number of wells can be calculated:

$$N = W_{total} / (Q_w / 2 T i)$$

The corresponding total extraction rate "Q" is:

$$Q = N Q_w$$

The downgradient extent of the capture zone for the system of wells located along the line perpendicular to the flow direction is the same for one well and two wells, if the wells are spaced at optimum distance to maximize the width of capture zone. This extent increases by a factor of 1.5 if three wells are used (reference 3, Table 5).

$$d_{one\ well} = Q_w / 2\pi T i$$

$$d_{two\ wells} = Q_w / 2\pi T i$$

$$d_{three\ wells} = (3/2) (Q_w / 2\pi T i)$$

Therefore, when wells are spaced to maximize the width of capture zone, unlike in the case of the lateral dimension (width), increasing the number of wells and the extraction rate does not necessarily produce a corresponding increase in the downgradient reach of the capture zone. The above does not apply when wells are spaced closer than the optimum distance for maximizing the width, where downgradient extent does increase with the increase in number of wells and total extraction rate.

MADE BY: *mo* DATE: *9/21/06*  
CHKD. BY: *AMM* DATE: *9/22/06*PROJECT: NYSDEC, Kliegman Bros. Site  
SUBJECT: Hydraulic Containment of the Dissolved-Phase PCE Contamination - Part 1

The extraction rate of a given well pumping from an unconfined aquifer can be related to the drawdown in that well as (reference 4, Equations 8-23 and 8-12):

$$H_0^2 - h_w^2 = (Q_w / \pi K) \ln(R/r_w)$$

$$R = 575 S_w (H_0 K)^{1/2}$$

$$S_w = H_0 - h_w$$

$$Q_w = (H_0^2 - h_w^2) \pi K / \ln[575 (H_0 - h_w) (H_0 K)^{1/2} / r_w]$$

However, wells are not fully efficient. Only some fraction "f" of the well drawdown  $s_w = H_0 - h_w$  is the "effective" drawdown, affecting the aquifer. The rest is used up by well losses. The extraction rate corrected for the presence of well losses is:

$$s_{w-eff} = f s_w = f (H_0 - h_w)$$

$$h_{w-eff} = H_0 - s_{w-eff} = H_0 - f s_w =$$

$$= H_0 - f (H_0 - h_w) = (1 - f) H_0 + f h_w$$

$$Q_w = (H_0^2 - h_{w-eff}^2) \pi K / \ln[575 (H_0 - h_{w-eff}) (H_0 K)^{1/2} / r_w]$$

Well capacity is the maximum extraction rate that can be achieved by a well. It corresponds to the maximum drawdown that can be developed in that well, i.e. the minimum saturated thickness that can be achieved in the well.

$$h_{w-eff-min} = (1 - f) H_0 + f h_{w-min}$$

$$Q_{w-max} = (H_0^2 - h_{w-eff-min}^2) \pi K / \ln[575 (H_0 - h_{w-eff-min}) (H_0 K)^{1/2} / r_w]$$

When the capture zone developed by a well pumping at, or below, its capacity is sufficient to create the required containment, only one well is needed. Otherwise, wells must be added to increase the extraction and the size of the capture zone.



PROJECT: NYSDEC, Kliegman Bros. Site

SUBJECT: Hydraulic Containment of the Dissolved-Phase PCE Contamination - Part 1**4. PARAMETERS****Thickness of saturated zone -  $H_0$** 

Local data on aquifer depth are not available as the borings did not reach clay. Based on reference 5, the Gardiners Clay occurs at the elevation of approximately -150 ft in the study area. Water table occurs at an elevation of approximately +20 ft (reference 2). Therefore, the thickness of the water-bearing zone is approximately 170 ft. Use 200 ft.

$$H_0 = 200 \text{ ft} = 60 \text{ m}$$

**Hydraulic conductivity -  $K$** 

Based on Table 1 of reference 6, hydraulic conductivity of the Upper Glacial aquifer is 20-80 ft/d or 200-300 ft/d, depending on the type of deposits. At the site, slug tests indicated very high conductivities, so the upper end values are more likely. Use:

$$K = 1 \cdot 10^{-1} \text{ cm/s} = 1 \cdot 10^{-3} \text{ m/s} = 283 \text{ ft/d}$$

**Hydraulic gradient -  $i$** 

Local gradient is very low, and it has not been well defined. Use regional gradient, based on the gradient in the Upper Glacial aquifer (reference 2).

$$i \approx 10 \text{ ft} / 10,000 \text{ ft} = 0.001$$

**Well radius -  $r_w$** 

The required extraction rate per well is expected to be high, based on the high hydraulic conductivity of the water-bearing zone. Use 10-inch wells.

$$r_w = 5 \text{ in} = 0.13 \text{ m}$$

**Minimum saturated thickness at well -  $h_{w-\text{min}}$** 

Assume that at least 85% of the saturated zone has to remain in saturation.

$$h_{w-\text{min}} = 0.85 * H_0 = 0.85 * 60 = 51 \text{ m}$$

**Well efficiency -  $f$** 

Assume that the efficiency of the extraction wells will be 30%.

$$f = 0.30$$

MADE BY: *MO* DATE: *8/21/06*CHKD. BY: *AMM* DATE: *9/22/06*

PROJECT: NYSDEC, Kliegman Bros. Site

SUBJECT: Hydraulic Containment of the Dissolved-Phase PCE Contamination - Part 1

## 5. CALCULATIONS

### Summary of parameters:

$H_0 = 60 \text{ m}$   
 $K = 0.001 \text{ m/s}$   
 $T = H_0 K = 60 * 0.001 = 0.06 \text{ m}^2/\text{s}$   
 $i = 0.001$   
 $r_w = 0.13 \text{ m}$   
 $h_{w-\text{min}} = 51 \text{ m}$   
 $f = 0.30$

### Calculate:

Calculations are performed by first developing the relationship between the well extraction rate and the size of the capture zone. Then, the extraction rate and corresponding capture zone size are evaluated with respect to the size of the plume and containment coverage.

Calculations of the extraction rate and dimensions of capture zone are performed in a spreadsheet table on page 12. An example calculation is provided below. Saturated thickness at the extraction well for the example calculation is 56.4 m.

$$h_w = 56.4 \text{ m } (H_0 = 60 \text{ m} > h_w = 56.4 \text{ m} > h_{w-\text{min}} = 51 \text{ m})$$

The effective saturated thickness at well is:

$$h_{w-\text{eff}} = (1 - f) H_0 + f h_w = (1 - 0.3) * 60 + 0.3 * 56.4 = 58.92 \text{ m}$$

Calculate the extraction rate:

$$Q_w = (H_0^2 - h_{w-\text{eff}}^2) \pi K / \ln[575(H_0 - h_{w-\text{eff}}) (H_0 K)^{1/2} / r_w]$$

$$\begin{aligned}
 Q_w &= (60^2 - 58.92^2) * \pi * 0.001 / \\
 &\quad \ln[575 * (60 - 58.92) (60 * 0.001)^{1/2} / 0.13] = \\
 &= 128.43 * \pi * 0.001 / \ln[575 * 1.08 * 0.245 / 0.13] = \\
 &= 0.403 / \ln(1,170.3) = 0.403 / 7.07 = 0.057 \text{ m}^3/\text{s}
 \end{aligned}$$

(905 gpm)

URS

PAGE 7 OF 35

JOB NO. 111 74 770

MADE BY: AB  
CHKD. BY: AMM

DATE: 9/21/06  
DATE: 9/22/06

PROJECT: NYSDEC, Kliegman Bros. Site

SUBJECT: Hydraulic Containment of the Dissolved-Phase PCE Contamination - Part 1

The lateral extent of the capture zone is:

$$W = Q_w / 2 T i$$

$$W = 0.057 / 2 * 0.06 * 0.001$$

$$W = 475 \text{ m (1,560 ft)}$$

The downgradient extent of the capture zone is:

$$d = Q_w / 2\pi T i$$

$$d = 0.0057 / 2 * \pi * 0.06 * 0.001$$

$$d = 151 \text{ m (500 ft)}$$

The extraction rate and the dimensions of capture zone are the same as those in the spreadsheet table.

The plots of capture zone dimensions as a function of the extraction rate is shown on page 13 of this calculation.

## 6. ANALYSIS

### The 1,000-ppb Area

The Kliegman Bros. property is located approximately 900 ft north from the farthest location of the 1,000-ppb isoconcentration line (see page 15). The most likely direction of ground water flow is to the south. Assume a target downgradient extent of 1,000 ft. A well placed on the property could create a capture zone with the downgradient extent of 1,000 ft - this would require an extraction rate of approximately 2,000 gpm (see plot on page 13). The aquifer should be able to provide this rate without major problems.

With the flow of  $Q = 2,000$  gpm (4.5 cfs), assuming an  $L = 100$ -ft long submerged screen, open screen area of  $f_{op} = 10\%$  and the maximum allowable velocity through the screen of  $v = 0.1$  ft/s, the required well diameter is:

$$D = Q / \pi L f v = 4.5 / \pi * 100 * 0.10 * 0.10 = 1.4 \text{ ft (17 in)}$$

Either a very large diameter well, or several standard wells would be required.

URS

PAGE 8 OF 35

JOB NO. 111 74 770

MADE BY: *mo* DATE: *8/21/06*  
CHKD. BY: *AMM* DATE: *9/22/06*

PROJECT: NYSDEC, Kliegman Bros. Site  
SUBJECT: Hydraulic Containment of the Dissolved-Phase PCE Contamination - Part 1

Note that the lateral extent of the capture zone associated with the extraction of 2,000 gpm is much greater than the width of the plume - approximately 3,100 ft (page 13) vs. the plume width approximately 800 ft (page 15). Therefore, the lateral containment of the plume is feasible.

Moreover, at the extraction rate of 2,000 gpm, the direction of ground water flow does not matter, as every dimension of the plume is less than the lateral extent of the capture zone (plume is approximately 1,200 by 800 ft, lateral extent is approximately 3,100 ft).

The lateral width of the 1,000-ppb area is approximately 800 ft (page 15), say 1,000 ft for the purpose of this calculation. The 1,000-ft wide capture zone can be created by extracting approximately 600 gpm (page 13). This is the lowest extraction rate where the 1,000-ppb area can be contained. At that extraction rate, the downgradient extent of the capture zone is approximately 300 ft (page 13). Therefore, the most efficient containment of the 1,000-ppb area would require well, or wells, placed within 300 ft of the downgradient extent of the plume. However, this would work only for the southerly flow direction.

#### The 10,000-ppb Area

The farthest distance from the property to the 10,000-ppb isoconcentration line is approximately 600 ft (page 15). From the plot on page 13, the extraction rate required to create the downgradient capture zone encompassing the 10,000-ppb line (i.e. 600 ft downgradient from the well), with the well or wells located at the Kliegman property, is approximately 1,000 gpm. The lateral extent of the capture zone associated with the extraction of 1,000 gpm is approximately 1,800 ft (page 13), which is greater than the lateral dimension of both the 10,000- and 1,000-ppb areas.

With the flow of  $Q = 1,000$  gpm (2.2 cfs), assuming the same parameters as those used before for the 2,000-gpm well:

$$D = Q / \pi L f v = 2.2 / \pi * 100 * 0.10 * 0.10 = 0.7 \text{ ft (8.4 in)}$$

A 10- to 12-in diameter well would be sufficient.

URS

PAGE 9 OF 35

JOB NO. 111 74 770

MADE BY: *mo* DATE: *8/21/06*  
CHKD. BY: *AMM* DATE: *9/22/06*

PROJECT: NYSDEC, Kliegman Bros. Site

SUBJECT: Hydraulic Containment of the Dissolved-Phase PCE Contamination - Part 1

The lateral dimension of the 10,000-ppb area is approximately 400 ft, assuming southerly flow (page 15). In order to contain it, extraction rate of approximately 200 gpm would be required (page 13). This is the lowest extraction rate that would produce containment. The downgradient extent of the capture zone associated with that extraction, and therefore, the distance from the well to the leading edge of the plume, is approximately 150 ft (page 13).

#### Overall Performance

As indicated earlier, the local flow direction is not well defined. Considering that, it would be informative to reiterate extraction requirements for well(s) located at the site, and able to provide hydraulic containment regardless of the flow direction.

For the 1,000-ppb area, a 2,000-gpm extraction rate would be required. The downgradient reach of capture zone is approximately 1,000 ft, the lateral extent is approximately 3,100 ft.

For the 10,000-ppb plume, the 1,000-gpm extraction provides a 600-ft downgradient extent of capture zone, and a 1,800-ft lateral extent.

In both cases, plume dimensions are lower than the dimensions of capture zones regardless of the flow direction.

Reduction in extraction rates could be accomplished by using wells placed near the leading edges of the plumes and targeting only the upper zone of the aquifer, where the dissolved contamination appears to be concentrated. Partially penetrating wells could be employed for that purpose. However, those wells would be effective only if placed in strategic locations near the downgradient edges of contaminated areas. Therefore, the local flow direction would have to be better defined.

Assuming a 50-ft deep containment zone, and the same gradient and conductivity as those employed in the previous calculations, the optimized extraction rates can be estimated as follows:

MADE BY: *pho* DATE: *8/21/06*  
 CHKD. BY: *AMM* DATE: *9/22/06*

PROJECT: NYSDEC, Kliegman Bros. Site  
 SUBJECT: Hydraulic Containment of the Dissolved-Phase PCE Contamination - Part 1

- For the 1,000-ppb area, largest dimension of 1,200 ft

$$W = Q_w / 2 T i \rightarrow Q_w = W 2 T i$$

$$Q_w = 1,200 * 2 * (50 * 283) * 0.001 =$$

$$= 34,000 \text{ ft}^3/\text{d} = 180 \text{ gpm}$$

- For the 10,000-ppb area, largest dimension of 600 ft

$$Q_w = 600 * 2 * (50 * 283) * 0.001 =$$

$$= 17,000 \text{ ft}^3/\text{d} = 90 \text{ gpm}$$

It appears that, depending on the area that must be contained and the selected depth of containment, extraction rate on the order of few hundred gallons per minute could be used. This; however, would require a good understanding of the local flow directions and placement of several wells in strategic locations near the downgradient edges of the plumes.

## 7. SUMMARY

In summary, a 1,000-gpm or a 2,000-gpm system would be required to contain the 10,000-ppb and 1,000-ppb plumes, respectively, by means of extracting ground water from the Kliegman Bros. property. Relatively large-diameter, deep wells, either fully penetrating or penetrating most of the aquifer thickness, would be required. These systems would perform well regardless of the flow direction.

Reduction of the extraction rates to approximately 100 to 200 gallons per minute could be accomplished by targeting only the top part of the aquifer with partially penetrating wells and by locating wells near the downgradient edges of the plumes. To fully evaluate that option, a better definition of the local flow direction would be required. Based on current data, it appears that the local flow direction may be variable. If that were confirmed, designing a low extraction rate system that would maintain the containment at all times may be difficult. In addition, the downgradient edges of the 1,000-ppb and 10,000-ppb plumes are located in residential areas. It is not clear whether wells can be installed in locations that would be required for the optimized system.

URS

PAGE 11 OF 35

JOB NO. 111 74 770

MADE BY: *mo*  
CHKD. BY: *AMM*

DATE: *3/21/06*  
DATE: *4/22/06*

PROJECT: NYSDEC, Kliegman Bros. Site

SUBJECT: Hydraulic Containment of the Dissolved-Phase PCE Contamination - Part 1

## 8. REFERENCES

1. Remedial Investigation Report  
Kliegmand Bros. Site  
URS Corporation Group Consultants, Final February 2004
2. Water-Table and Potentiometric-Surface Altitudes of the  
Upper glacial, Magothy, and Lloyd Aquifers on Long  
Island, New York, in March-April 200, with a Summary of  
Hydrogeologic Conditions  
U.S. Geological Survey  
Water-Resources Investigations Report 01-4165
3. Groundwater Contamination  
Optimal Capture and Containment  
S.M. Gorelick, R.A. Freeze, D. Donohue, J.F. Keely  
Lewis Publishers, 1993
4. Hydraulics of Groundwater  
J. Bear  
McGraw-Hill, 1979
5. Hydrologic Framework of Long Island, New York  
D.A. Smolensky, H.T. Buxton, P.K. Shernoff  
U.S. Geological Survey, 1989
6. Simulation of Ground-Water Flow and Pumpage in Kings  
and Queens Counties, Long Island, New York  
U.S. Geological Survey  
Water-Resources Investigations Report 98-4071

Calculates extent of capture zone based on theory of wells in uniform flow.  
 Wells extract from an unconfined aquifer.

pg 12  
 0.35

$$h_{w\text{-eff}} = (1 - f) H_0 + f h_w$$

$$Q_w = (H_0^2 - h_{w\text{-eff}}^2) \pi K / \ln[575 (H_0 - h_{w\text{-eff}}) (H_0 K)^{1/2} / r_w]$$

$$W = Q_w / 2 T i$$

$$d = Q_w / 2 \pi T i$$

Where:

f - well efficiency, [-]

H<sub>0</sub> - undisturbed saturated thickness, [m]

h<sub>w</sub> - saturated thickness in extraction well, [m]

h<sub>w-eff</sub> - effective saturated thickness at extraction well, [m]

i - hydraulic gradient, [-]

K - hydraulic conductivity, [m]

Q<sub>w</sub> - extraction rate, [m<sup>3</sup>/s]

r<sub>w</sub> - radius of extraction well, [m]

T - transmissivity of aquifer, [m<sup>2</sup>/s]

Data:

saturated thickness	H <sub>0</sub> =	60.0 m/s	
hydraulic conductivity	K =	1.0E-01 cm/s =	0.001 m/s
hydraulic gradient	i =	0.001	
well radius	r <sub>w</sub> =	0.13 m	
well efficiency	f =	0.3	
minimum sat. thick. at well	h <sub>w-min</sub> =	51.0 m	

number	saturated thickness in well h <sub>w</sub> [m]	effective saturated thickness at well h <sub>w-eff</sub> [m]	extraction rate Q <sub>w</sub> [m <sup>3</sup> /s]	dimensions of capture zone		extraction rate Q <sub>w</sub> [gpm]	dimensions of capture zone	
				lateral W [m]	downgr. d [m]		lateral W [ft]	downgr. d [ft]
1	59.55	59.87	0.0102	85.0	27.0	162	279	89
2	59.10	59.73	0.0179	149.0	47.4	283	489	156
3	58.65	59.60	0.0250	208.4	66.3	396	684	218
4	58.20	59.46	0.0318	265.1	84.4	504	869	277
5	57.75	59.33	0.0384	319.7	101.8	608	1,049	334
6	57.30	59.19	0.0448	372.9	118.7	709	1,223	389
7	56.85	59.06	0.0510	424.9	135.3	808	1,394	444
8	56.40	58.92	0.0571	475.9	151.5	905	1,561	497
9	55.95	58.79	0.0631	526.0	167.4	1,000	1,725	549
10	55.50	58.65	0.0690	575.4	183.2	1,094	1,887	601
11	55.05	58.52	0.0749	624.0	198.6	1,186	2,047	652
12	54.60	58.38	0.0807	672.1	213.9	1,277	2,204	702
13	54.15	58.25	0.0863	719.6	229.0	1,368	2,360	751
14	53.70	58.11	0.0920	766.5	244.0	1,457	2,514	800
15	53.25	57.98	0.0976	812.9	258.8	1,545	2,666	849
16	52.80	57.84	0.1031	858.9	273.4	1,633	2,817	897
17	52.35	57.71	0.1085	904.5	287.9	1,719	2,967	944
18	51.90	57.57	0.1140	949.7	302.3	1,805	3,115	992
19	51.45	57.44	0.1193	994.5	316.5	1,890	3,262	1,038
20	51.00	57.30	0.1247	1,038.9	330.7	1,975	3,408	1,085

EXAMPLE  
 ← CALC.



### Kliegman Bros. Lateral and Downgradient Extent of Capture Zone as a Function of Extraction Rate

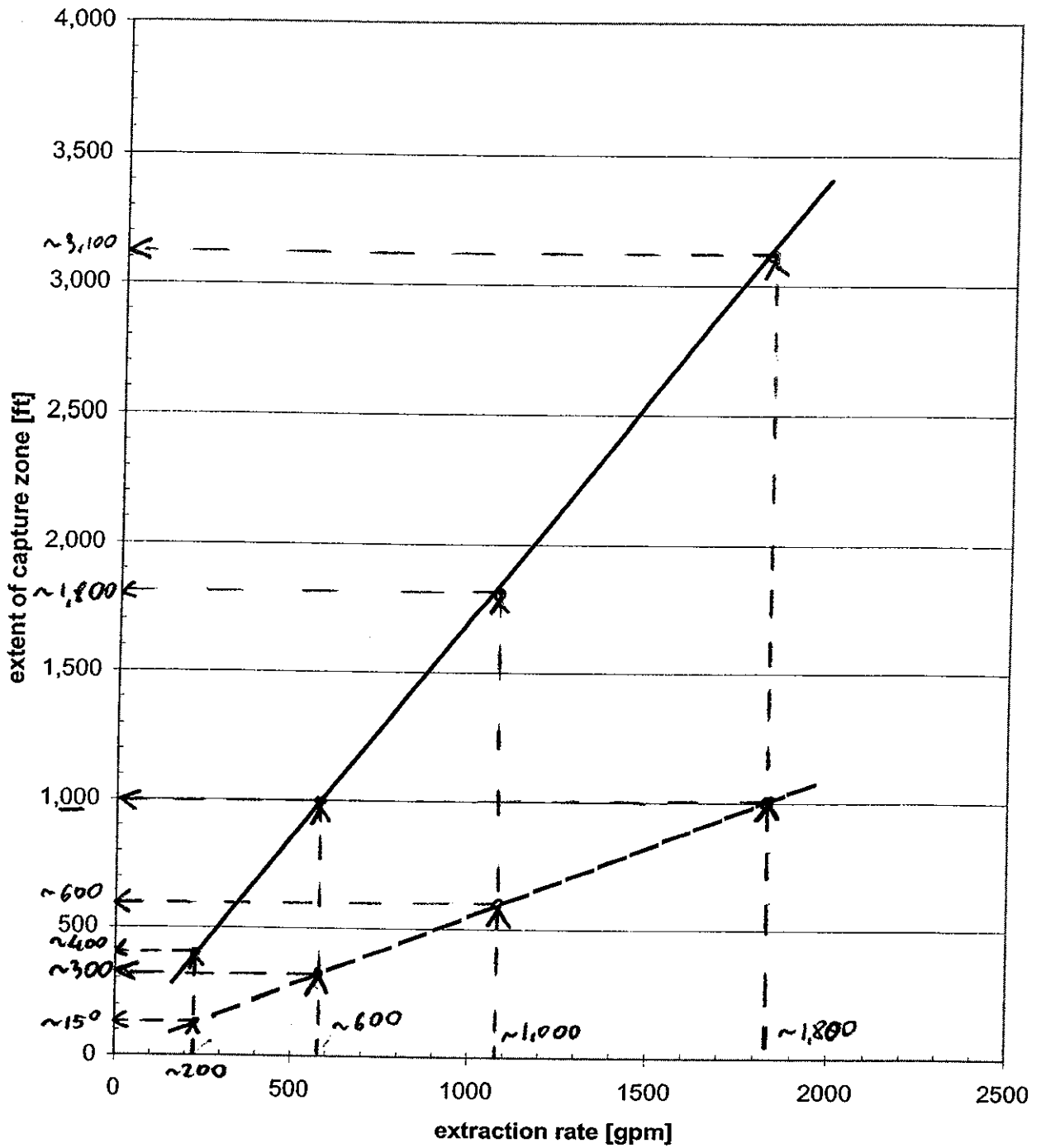

— lateral    - - downgradient

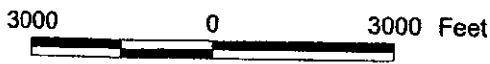
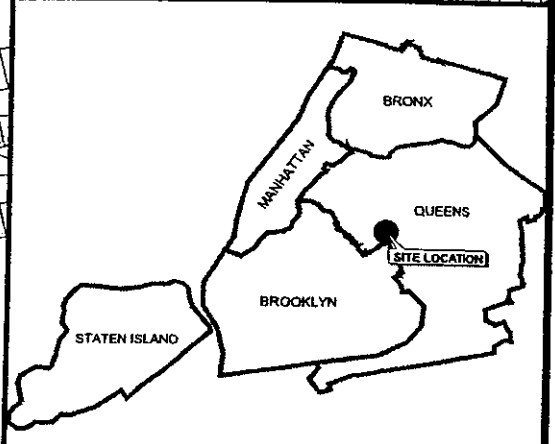
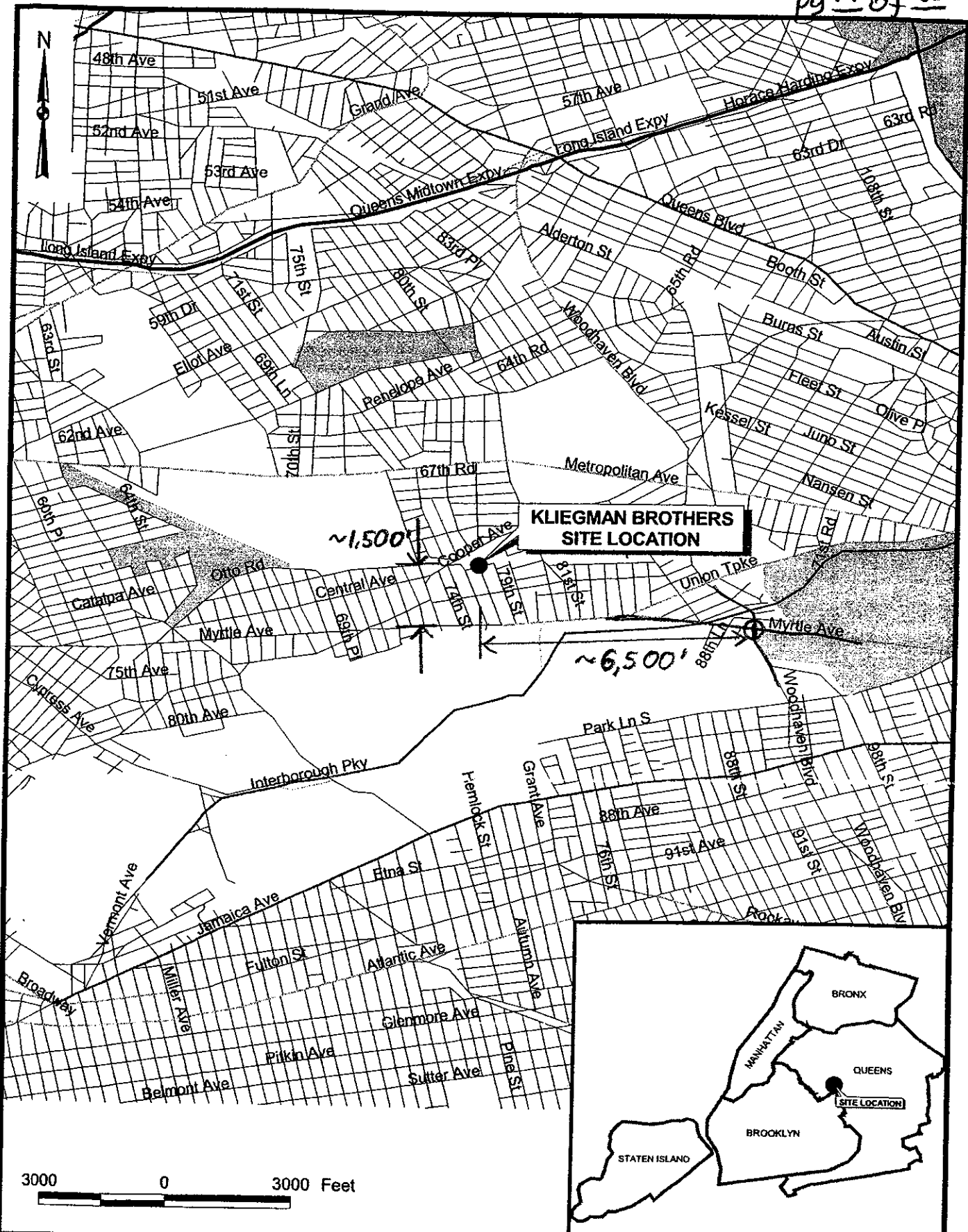

N:\11171964\_000000\B\GIS\site.apr SITE LOCATION  
 7/22/2005

**URS**

KIEGMAN BROTHERS  
SITE LOCATION MAP

FIGURE 1-1



**REMEDIAL INVESTIGATION REPORT**

**KLIEGMAN BROS. SITE  
SITE #2-41-031  
GLENDALE, NEW YORK**

**Prepared For:**

**NYS DEPARTMENT OF ENVIRONMENTAL CONSERVATION  
DIVISION OF ENVIRONMENTAL REMEDIATION  
WORK ASSIGNMENT D003825-37**

Reference 1

**FINAL**

**Prepared By:**

**URS CORPORATION GROUP CONSULTANTS  
640 ELLICOTT STREET  
BUFFALO, NEW YORK 14203**

**FEBRUARY 2004**

ps 17  
of 35

### **3.0 PHYSICAL CHARACTERISTICS OF THE STUDY AREA**

#### **3.1 Surface Features**

The primary surface feature at the site is a two-story brick building occupying 26,000 square feet. North of the building there is a paved parking area/storage yard. The site is located in Queens County within the Atlantic Coastal Lowland physiographic province. The topography of Queens County is the result of late Wisconsin stage glaciation. The east-west trending Harbor Hill terminal moraine ridge is located less than one mile south of the site. The grade at the site is generally flat with an elevation of approximately 100 feet above mean sea level (msl).

#### **3.2 Demography and Land Use**

Land uses near the site include limited industrial, general industrial, residential, neighborhood business, general business residential, and business.

#### **3.3 Soils**

Soils in the vicinity of the site have been mapped as urban lands which are characterized as miscellaneous areas greater than 80 percent covered by asphalt, concrete, buildings, or impervious structures (USDA-SCS, 1990).

#### **3.4 Surface Water Hydrology**

##### **3.4.1 Site Drainage**

The grade at the site is generally flat except for the Cooper Avenue underpass under the Long Island Public Railroad tracks northwest of the site. No surface water exists in the general vicinity of the site. Surface drainage is predominantly overland flow to nearby storm drains.

#### **3.5 Geology and Hydrogeology**

The hydrogeology and geology in the site vicinity were studied as part of this RI. Information obtained from other studies conducted near the site and from various literature

sources also were used to help characterize the hydrogeology. The following subsections summarize the regional and site-specific geology and hydrogeology.

### 3.5.1 Geology

#### 3.5.1.1 Regional Geology

The stratigraphy of Queens County consists of Upper Cretaceous and Pleistocene sands, gravels, and clays which overlie southeasterly sloping bedrock. Bedrock in Queens County consists of Precambrian age, crystalline, igneous and metamorphic rocks which outcrop in northwestern Queens County, dip steeply to the southeast at a gradient of 40 to 80 feet per mile and is expected to occur at approximately 500 feet below grade at the site.

The Cretaceous sediments directly overlying bedrock are divided into the Raritan and overlying Magothy formations. The Raritan formation is composed of the Lloyd sand member and a clay member. The Magothy formation consists of a great thickness of alternating fine sands, clays, silts, and some coarse beds of sand and gravel (USGS, 1992).

The Pleistocene deposits are divided into three units: the Jameco gravel, the Gardiners clay, and Upper Pleistocene glacial drift deposits. The oldest fluvial deposit, the Jameco gravel, is separated from the Upper Pleistocene drift by the Gardiners clay.

#### 3.5.1.2 Site Geology

The site-specific geology was obtained from boring logs from previous subsurface investigations at the site and activities performed during this investigation. In general, beneath a fill layer (concrete or asphalt underlain by reworked native materials) of variable thickness (up to two feet), brown loose to dense, fine to coarse silty sand to sandy silt with localized sandy clay seams was observed to depths of approximately 10 feet bgs. This was underlain by brown loose to dense, fine to coarse sand with variable amounts of fine to coarse gravel to depths of 148 feet bgs. This unit appears to correlate to the Upper Pleistocene glacial deposits and the more recent Holocene deposits. Beneath the eastern portion of the site a brown silty clay layer, with variable

amounts of sand was penetrated in borings MW-01S, MW-06S, MW-07D/MW-13H, MW-16D. At some areas the layer could be described as an interbedded silty clay and silty fine sand. It was not present in MW-10H. The silty clay layer occurs at approximately 10-15 feet bgs and is approximately five feet thick until it appears to pinch out in the vicinity of MW-04D. A wet clayey sandy silt was observed there but at much less thickness than elsewhere on the site. As part of the FRI conducted by Enviroscience, a clay to silty clay layer was present in the upper 10 to 15 feet of overburden. In general, the clayey seams were typically 2- to 3- feet thick interstratified with sands and silt. The clay seams were identified in borings EB-3, EB-4, SVE-2, SVE-4 and SVE-5 (Figure 1-3). Perched groundwater is observed above the silty clay layer where it was encountered. Figure 2-2 depicts the locations of cross-sections A-A' and B-B' which are shown in Figures 3-1 and 3-2, respectively.

### 3.5.2 Hydrogeology

#### 3.5.2.1 Regional Hydrogeology

There are six major hydrogeologic units identified in the vicinity of the site. They are in ascending order: 1) the Lloyd aquifer; 2) the Raritan confining unit; 3) the Magothy aquifer; 4) the Jameco aquifer; 5) the Gardiners Clay; and 6) the upper glacial (i.e., Pleistocene) deposits. As part of the remedial investigation field activities, only the upper glacial deposits were penetrated. However, in general, the aquifers are laterally extensive and yield significant quantities of water. The most permeable units are the sands and gravels. The two clayey units represent confining units with vertical hydraulic conductivities of 0.001 ft/day (USGS, 1995). These are several orders of magnitude less than the sands and gravels. Where present, the confining units restrict groundwater movement between the aquifers. Bedrock underlying the area is of low hydraulic conductivity with yields of only a few gallons per minute. The Lloyd aquifer reportedly yields as much as 1,600 gpm with rates more typically less than 1,000 gpm. The hydraulic conductivity of the Jameco-Magothy aquifer is estimated to range from 60 ft/day to 90 ft/day (USGS, 1995). Well yields are reported to be as high as 1,500 gpm. The upper glacial aquifer consists of sand and gravel beds deposited south of the terminal moraine. These deposits are capable of yielding large quantities of water. These soils were penetrated as part of the drilling program. Horizontal hydraulic conductivities have been estimated as high as 270

ft/day. Wells yields reportedly are as high as 1,500 gpm. Water in the upper glacial aquifer is under unconfined conditions but may be confined locally between beds of clay and silt (USGS, 1995). The regional groundwater flow direction is south to south-southwest.

### 3.5.2.2 Site Hydrogeology

The regional groundwater table occurs at the site at approximately 70 feet bgs within the upper glacial aquifer. However, perched groundwater was observed in several wells above the clay layer in the eastern portion of the site. Measurements of groundwater elevations were used to develop groundwater contour maps and generally determine the site-specific direction of groundwater flow in the perched groundwater zone, the water table aquifer, and the deeper groundwater zone approximately 30- to 40-feet below the water table. The data are summarized in Table 3-1. Perched water is present in the eastern portion of the site at depths of 10-12 feet bgs. Water is perched on top of a silty clay layer of varying thickness, dipping slightly to the west and pinching out at a point east of well MW-04D. Figures 3-3 and 3-4 shows groundwater elevations and flow direction on April 29-30, 2003 and on December 16, 2003, respectively. The groundwater flow direction in the perched water zone is towards the southwest at a gentle gradient. The flow direction in the perched zone was somewhat variable on other dates measured, possibly due to local fluctuations in the perched zone. The data on April 29-30 and December 16, 2003 appear to be most reliable.

In the shallow regional groundwater zone, groundwater measurements indicate that the flow direction varies. Figures 3-5 through 3-8 show groundwater elevations and flow direction on October 15, 2002, March 12, 2003, April 29-30, 2003, and December 16, 2003. On October 15, 2002, groundwater flow direction was northerly at a very gentle horizontal hydraulic gradient. On March 12, 2003, the groundwater flow direction was northerly at a very gentle horizontal hydraulic gradient. The April 29-30, 2003 and December 16, 2003 figures have additional data from the wells installed during the second field effort. These show that while the gradient defined by the first phase wells (MW-02D, MW-03D, MW-04D, MW-05D, and MW-07D) points north, when taking into account all the wells, the overall groundwater flow direction was generally towards the south at a very gentle horizontal hydraulic gradient, with a curious local depression identified at MW-02). The local depression at MW-02 accounted for the



pg 21  
of 35

apparent northward gradient observed with only the first phase wells in the ground. In general, the groundwater flow direction in the shallow groundwater zone was determined to be variable, possibly due to the very gentle horizontal hydraulic gradients and seasonal fluctuations in the water table.

In the deeper groundwater zone (approximately 30- to 40-feet below the water table), the groundwater flow direction appears to be towards the southeast on April 29-30, 2003 (see Figure 3-9). However, the well screens in the deeper bedrock zone are at different depths, and as a result, the actual direction of groundwater flow cannot be determined with certainty. The horizontal hydraulic gradient was nearly flat.

There is little to no discernible vertical hydraulic gradient observed at the paired deep and shallow groundwater wells.

Hydraulic conductivity of the aquifer was estimated by conducting slug tests. Tests were performed by inserting (falling head test) or removing (rising head test) a stainless-steel slug of known volume and recording the rate of recovery of the water level in the well. The slug test data was analyzed using the methods of Bouwer and Rice (1976) and/or Bouwer (1989). Appendix E summarizes the hydraulic conductivity and presents the raw data.

The hydraulic conductivity ranged from greater than  $1.85 \times 10^{-1}$  in centimeters per second (cm/sec) in MW-02 to  $1.45 \times 10^{-4}$  cm/sec in MW-01. The data from several slug tests were not measurable due to a very fast recharge rate. The average hydraulic conductivity for the site is approximately  $5 \times 10^{-2}$  cm/sec. The overall average conductivity is actually much higher because the data from several slug tests were not measurable due to a very fast recharge rate. In general, measured hydraulic conductivity values were one to two orders of magnitude higher in the water-table wells compared to wells monitoring the perched groundwater.

In cooperation with  
New York City Department of Environmental Protection  
Suffolk County Department of Health Services  
Suffolk County Water Authority

Pg 22 of 15

# Water-Table and Potentiometric-Surface Altitudes of the Upper Glacial, Magothy, and Lloyd Aquifers on Long Island, New York, in March-April 2000, with a Summary of Hydrogeologic Conditions

Water-Resources Investigations Report 01-4165

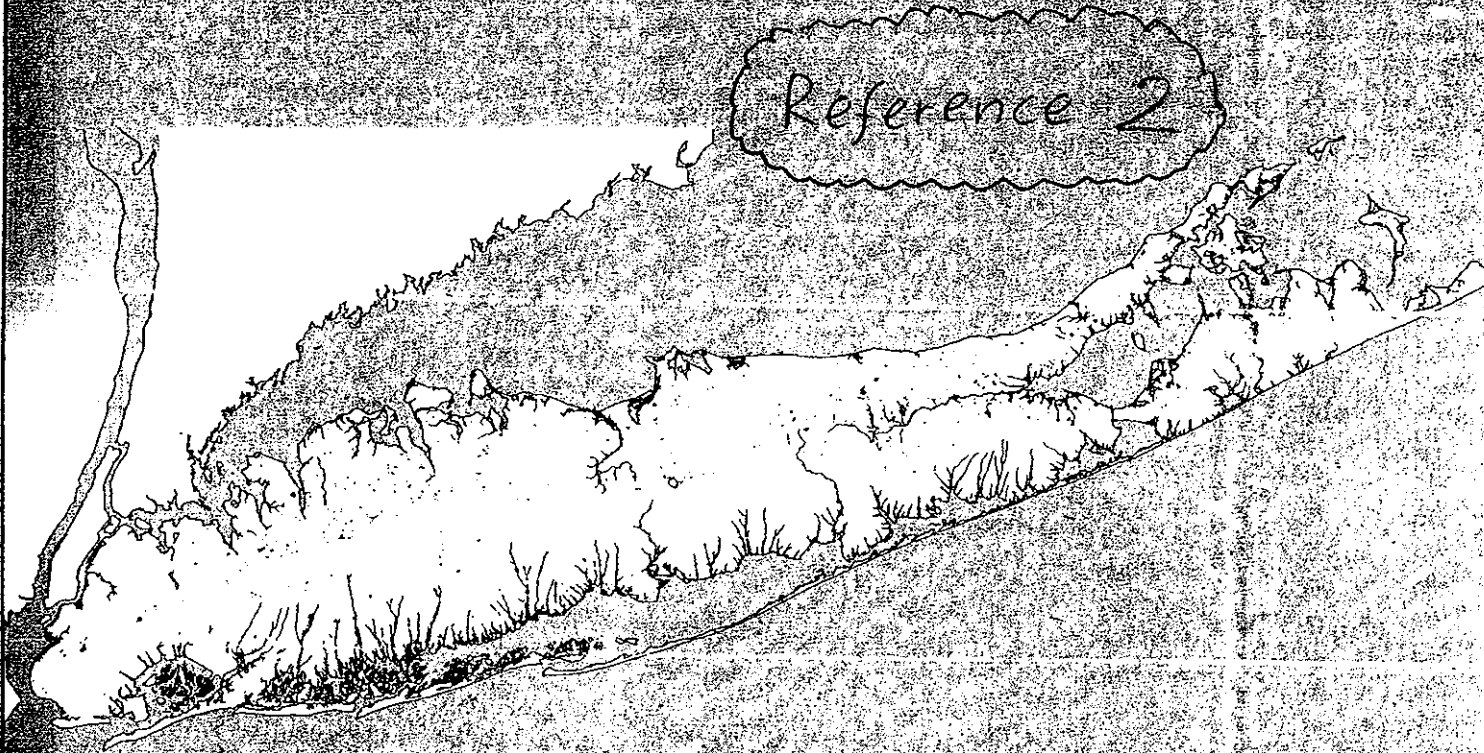

40°  
52'  
30"

pg 23  
of 35

Gradient

$$i = \frac{20-10}{10,000} =$$

$$= \frac{10}{10,000} =$$

$$= 0.001$$

45'

37'  
30"

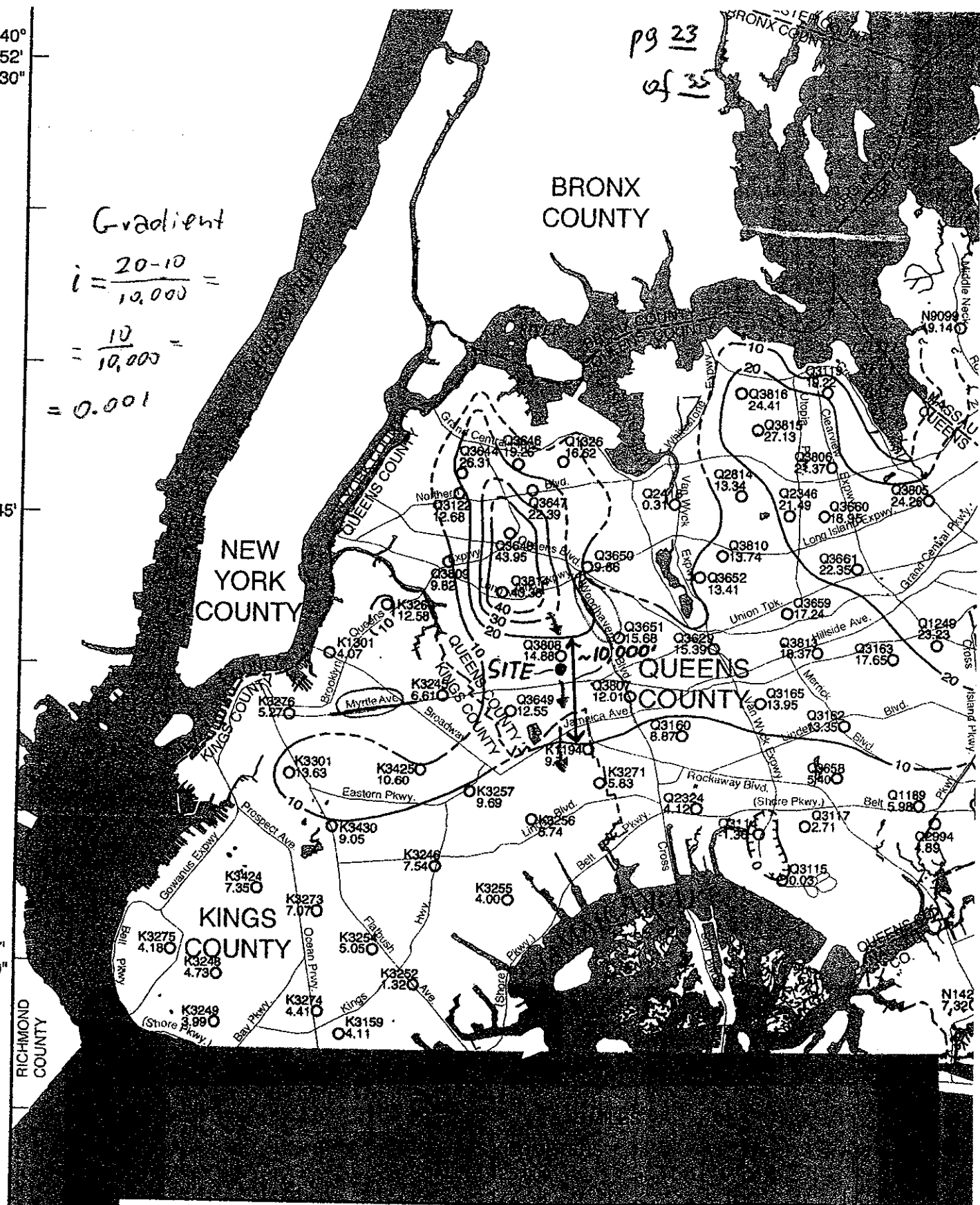

**WATER TABLE OF THE UPPER GLACIAL AQUIFER  
WESTERN LONG ISLAND, NEW YORK, IN MARCH-APRIL 2000**

Base digitized  
and New York  
July 1990

By  
Ronald Busciolano  
2001

C

pg 24

of 35

# Groundwater Contamination

Optimal Capture  
and Containment

Reference 3

Steven M. Gorelick

R. Allan Freeze

David Donohue

Joseph F. Keely



**LEWIS PUBLISHERS**

Boca Raton Ann Arbor London Tokyo

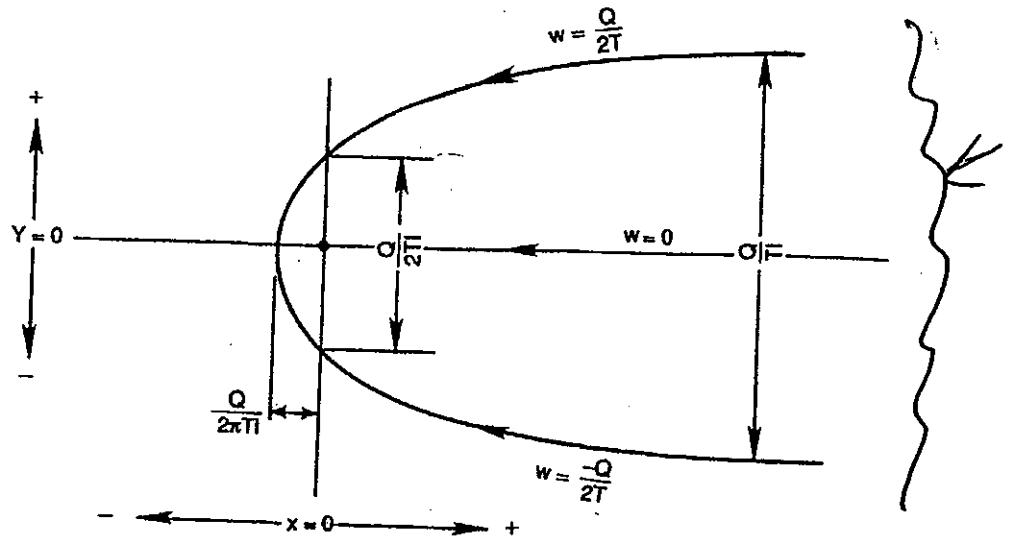

Figure 12. Equation for the dividing streamlines separating the capture zone of a single well from the rest of an aquifer.

and no flow tubes (or contaminants) can slip between the extraction wells. For two or three equally spaced wells, located along a line perpendicular to the regional gradient, and all pumping at the same rate, Javandel and Tsang provide the recommended spacings listed in the right-hand column of Table 5.

The design methodology for a one-, two-, or three-well extraction system using Table 5 involves a trial-and-error procedure with a set of alternative well networks. One tries to identify the lowest cost network that will meet the following specifications, given measured values for aquifer transmissivity,  $T$ , and regional hydraulic gradient,  $I$ :

1. The capture-zone geometry, as indicated by the values given in Table 5 for the distance between dividing streamlines, must be adequate to encompass the known boundaries of the contaminant plume.
2. The pumping rate,  $Q$ , to be applied at each of the wells, must not create drawdowns in excess of any constraints on the available drawdown at the wells.
3. The distances between the wells must be equal to or less than the recommended distances given in Table 5.

It must be emphasized that use of Table 5 to design remedial well networks will *not* lead to an optimal design. The limitations on the analytical solutions on which the table is based are too severe. It will provide a design that works for a pre-specified number of wells, all on a

Table 5. Parameters for Design of Remedial Well Fields Based on Javandel and Tsang (1986) Capture-Zone Theory. For multiple-well systems, Q is the constant pumping rate applied to each well.

Number of Wells	Distance Between Dividing Streamlines at Line of Wells	Distance Between Dividing Streamlines Far Upstream From Wells	Downstream Distance to Stagnation Point at Center Point of Capture Zone	Recommended Distance Between Each Pair of Extraction Wells
1	$\frac{Q}{2Tl}$	$\frac{Q}{Tl}$	$\frac{Q}{2\pi Tl}$	—
2	$\frac{Q}{Tl}$	$\frac{2Q}{Tl}$	$\frac{Q}{2\pi Tl}$	$\frac{Q}{\pi Tl}$
3	$\frac{3Q}{2Tl}$	$\frac{3Q}{Tl}$	$\frac{3Q}{4\pi Tl}$	$\frac{3\sqrt{2}Q}{\pi Tl}$

pg 27

of 35

**McGRAW-HILL  
BOOK COMPANY**

New York  
St. Louis  
San Francisco  
Auckland  
Bogotá  
Hamburg  
London  
Madrid  
Mexico  
Montreal  
New Delhi  
Panama  
Paris  
São Paulo  
Singapore  
Sydney  
Tokyo  
Toronto

Reference 4

**JACOB BEAR**

*Department of Civil Engineering  
Technion—Israel Institute of Technology  
Haifa  
Israel*

River

s and

# Hydraulics of Groundwater

3-17)

3-18)

m in  
ever,

R

rate  
veen  
ntial

-19)

lary

-20)

ace.  
ches  
dif-  
ted)

irge

ral,  
the

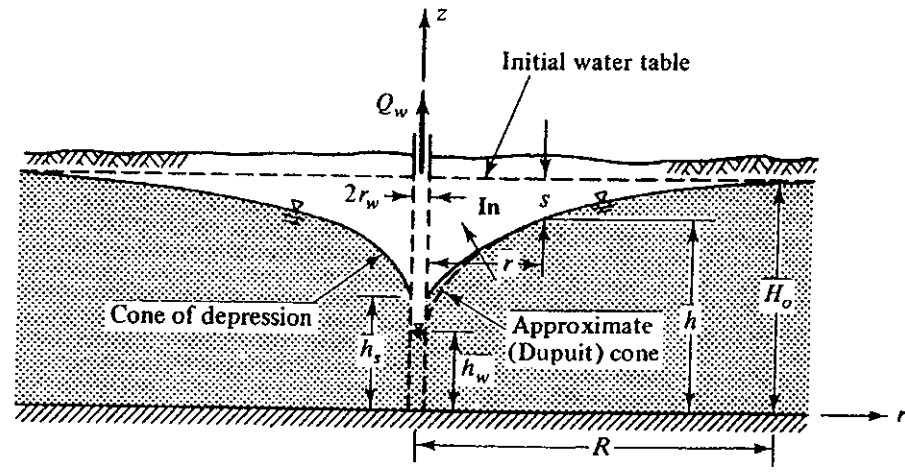

Figure 8-6 Radial flow to a well in a phreatic aquifer.

height of the phreatic surface,  $h$ , in the form of an equation which is solvable by iteration. His potential function is obtained by assuming that a certain fictitious flow exists in the region above the phreatic surface and below the horizontal plane at  $z = H_0$ , such that the boundary conditions on the phreatic surface are satisfied also by the potential of this flow.

Numerical methods have also been often applied to the solution of the problem as stated by (8-19) and (8-20).

By using the *Dupuit assumptions*, an easily integrable linear continuity equation can be derived. The results are accurate enough for distances  $r > 1.5h$  from a well. In this approach, the seepage face is neglected. Hansen (1949) gives graphs of  $Q/Kr_w^2$  as a function of  $h_s/r_w$  and  $h_w/r_w$  (Fig. 8-7). Boulton (1951) suggests

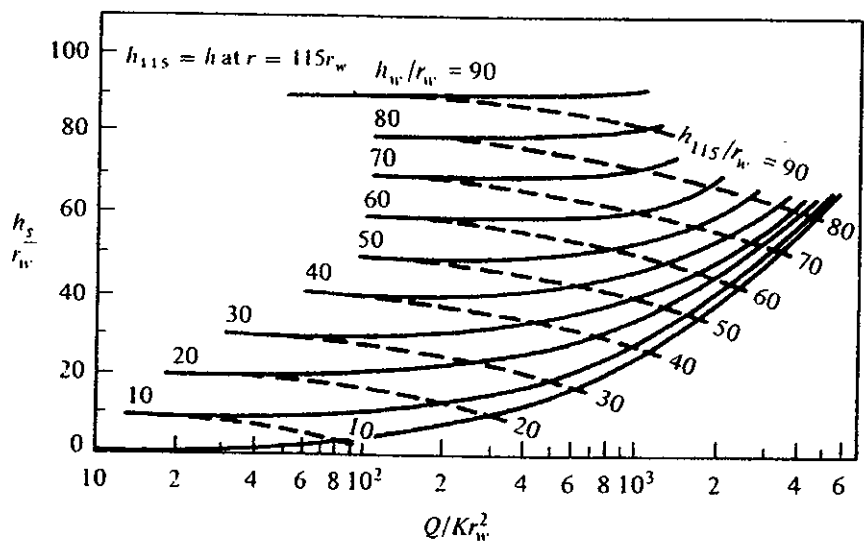

Figure 8-7 Discharge of a well in a phreatic aquifer (Hansen, 1949).



By integrating (8-1) from  $r_w$  to  $R$ , we obtain

$$s_w = H - h_w = \phi(R) - \phi(r_w) = (Q_w/2\pi T) \ln(R/r_w) \quad (8-4)$$

Between any two distances  $r_1$  and  $r_2 (> r_1)$ , we obtain

$$\phi(r_2) - \phi(r_1) = s(r_1) - s(r_2) = (Q_w/2\pi T) \ln(r_2/r_1) \quad (8-5)$$

Equation (8-5) is called the Thiem equation (Thiem, 1906).

Between any two distances  $r$  and  $R$ , we obtain

$$s(r) = \phi(R) - \phi(r) = (Q_w/2\pi T) \ln(R/r) \quad (8-6)$$

By dividing (8-3) by (8-4), we obtain

$$\phi(r) - h_w = (H - h_w) \frac{\ln(r/r_w)}{\ln(R/r_w)} \quad (8-7)$$

showing that the shape of the curve  $\phi = \phi(r)$ , given  $h_w$  and  $H$  at  $r_w$  and  $R$ , respectively, is independent of  $Q_w$  and  $T$ .

The distance  $R$  in (8-4), (8-6), and (8-7), where the drawdown is zero, is called the *radius of influence of the well*. Since we have established above that steady flow cannot prevail in an infinite aquifer, the distance  $R$  should be interpreted as a parameter which indicates the distance beyond which the drawdown is negligible, or unobservable. In general, this parameter has to be estimated from past experience. Fortunately,  $R$  appears in (8-6) in the form of  $\ln R$  so that even a large error in estimating  $R$  does not appreciably affect the drawdown determined by (8-6). The same observation is true also for another parameter—the radius of the well  $r_w$  (Sec. 8-1).

Various attempts have been made to relate the radius of influence,  $R$ , to well, aquifer, and flow parameters in both steady and unsteady flow in confined and phreatic aquifers. Some relationships are purely empirical, others are semi-empirical. For example (Bear, Zaslavsky, and Irmay, 1968).

Semi-empirical formulas are

$$\text{Lembke (1886, 1887):} \quad R = H(K/2N)^{1/2}, \quad (8-8)$$

$$\text{Weber (Schultze, 1924):} \quad R = 2.45 (HKt/n_e)^{1/2}, \quad (8-9)$$

$$\text{Kusakin (Aravin and Numerov, 1953):} \quad R = 1.9 (HKt/n_e)^{1/2} \quad (8-10)$$

Empirical formulas are

$$\text{Siehardt (Chertousov, 1962):} \quad R = 3000s_w K^{1/2}, \quad (8-11)$$

$$\text{Kusakin (Chertousov, 1949):} \quad R = 575s_w (HK)^{1/2} \quad (8-12)$$

where  $R$ ,  $s_w$  (= drawdown in pumping well), and  $H$  are in meters and  $K$  in meters per second.

In phreatic aquifers (Sec. 8-3)  $N$ ,  $H$ , and  $n_e$  represent accretion from precipitation, the initial thickness of the saturated layer, and the specific yield (or effective porosity) of the aquifer, respectively. In confined aquifers,  $H$  and  $n_e$  have to be

the relationship

$$h_s - h_w \approx (H_0 - h_w) - 3.75Q_w/2\pi KH_0 \quad (8-21)$$

where 3.75 is replaced by 3.5 if  $r_w/H_0$  is of the order 0.25.

Consider a cylinder of radius  $r$  around the well. For the considered steady flow, the Dupuit assumptions lead to

$$Q_w = 2\pi rhq_r = 2\pi rhKdh/dr = 2\pi rK\partial(h^2/2)/\partial r \quad (8-22)$$

where  $q_r$  is the specific discharge in the radial direction. Integrating between  $h = h_w$  at  $r = r_w$  and  $h = H_0$  at  $r = R$ , we obtain

$$H_0^2 - h_w^2 = \frac{Q_w}{\pi K} \ln(R/r_w) \quad (8-23)$$

In this integration, we have completely neglected the seepage face and made  $h_s$  identical to  $h_w$ . By integrating from some distance  $r$  to the external boundary at  $R$ , we obtain

$$H_0^2 - h^2 = \frac{Q_w}{\pi K} \ln(R/r) \quad (8-24)$$

Dividing (8-24) by (8-23) gives

$$H_0^2 - h^2 = (H_0^2 - h_w^2) \frac{\ln(R/r)}{\ln(R/r_w)} \quad (8-25)$$

The dashed curve in Fig. 8-6 gives the phreatic surface elevations,  $h = h(r)$ , as expressed by (8-25). It is interesting to note that neither  $Q_w$  nor  $K$  appear in (8-25). From (8-24), it follows that as  $r \rightarrow \infty$ ,  $h \rightarrow \infty$ , which is obviously impossible. This means that *steady flow is impossible in an infinite aquifer*. The equation is, therefore, valid only in the vicinity of the well.

Equation (8-23) is known as the *Dupuit-Forchheimer well discharge formula*. It is an exact solution of the continuity equation (in polar coordinates) based on the Dupuit assumptions

$$\partial Q/\partial r = 0 = \partial(2\pi rhK\partial h/\partial r)/\partial r = \partial(\pi K r \partial h^2/\partial r)/\partial r \quad (8-26)$$

or

$$\partial^2(h^2)/\partial r^2 + (1/r)\partial(h^2)/\partial r = 0 \quad (8-27)$$

which is linear in  $h^2$ .

Equation (8-24) may also be written as

$$H_0 - h = \frac{1}{(H_0 + h)} \frac{Q_w}{\pi K} \ln(R/r) \quad (8-28)$$

For a thick aquifer and small drawdown,  $(H_0 - h) \ll H_0$ ,  $H_0 + h \approx 2H_0$ , and (8-24) may be approximated by

$$s = \frac{Q_w}{\pi K(H_0 + h)} \ln \frac{R}{r} \quad \text{or} \quad s = \frac{Q_w}{2\pi T} \ln \frac{R}{r} \quad (8-29)$$

DEPARTMENT OF THE INTERIOR  
U.S. GEOLOGICAL SURVEY

**HYDROLOGIC FRAMEWORK OF LONG ISLAND, NEW YORK**

**By D.A. Smolensky, H.T. Buxton, and P.K. Shernoff**

Prepared in cooperation with the  
NEW YORK CITY DEPARTMENT OF ENVIRONMENTAL PROTECTION,  
NASSAU COUNTY DEPARTMENT OF PUBLIC WORKS,  
SUFFOLK COUNTY WATER AUTHORITY and DEPARTMENT OF HEALTH SERVICES

Reference 5



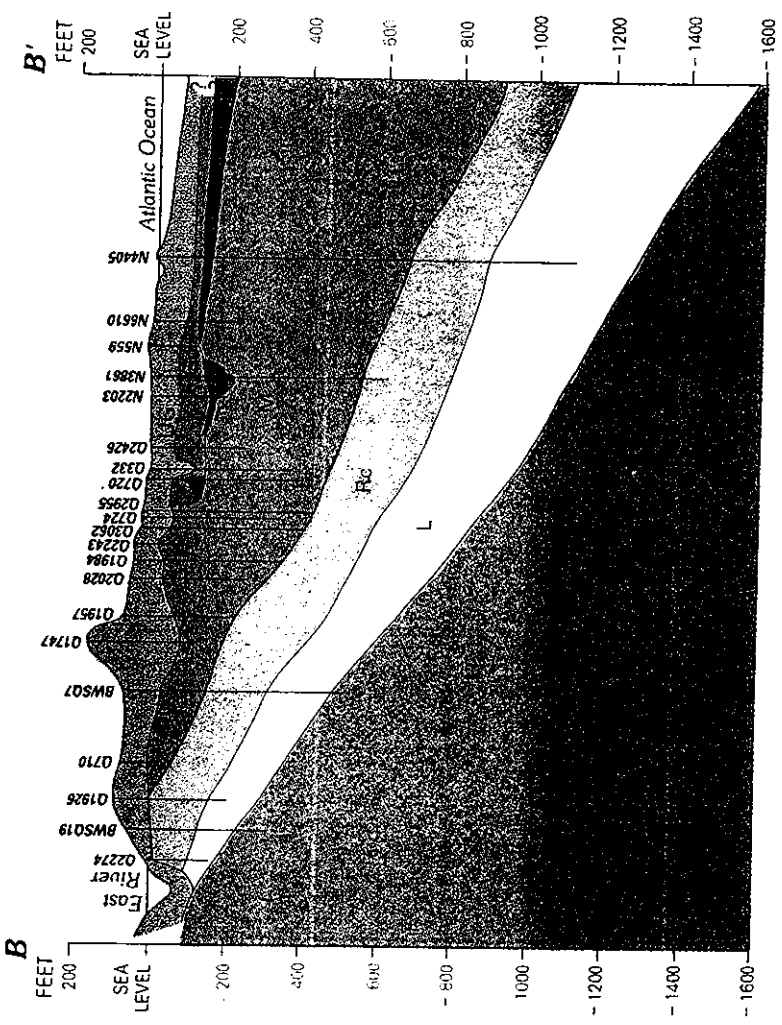
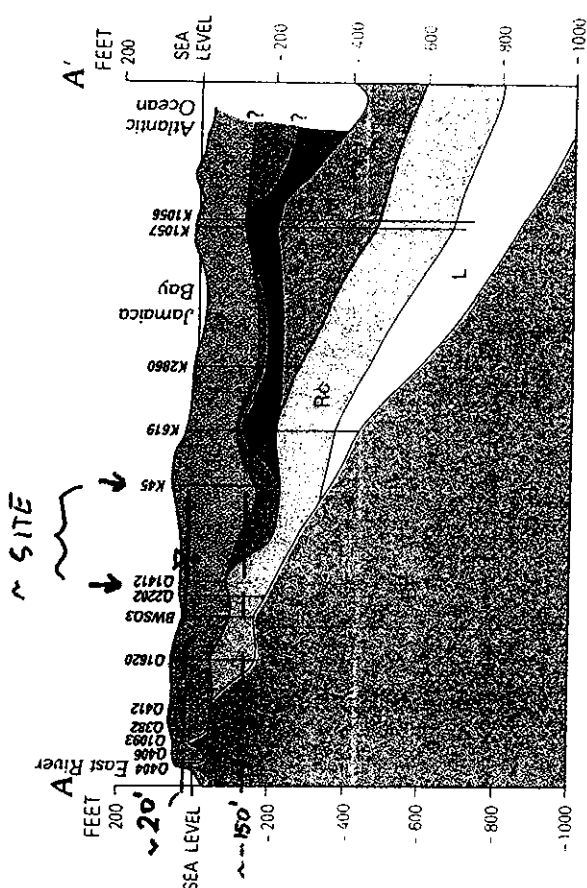

UG - Upper Glacial aquifer  
 Gc - Gardiners Clay  
 J - Jameco aquifer  
 M - Magothy aquifer  
 Rc - Raritan Clay

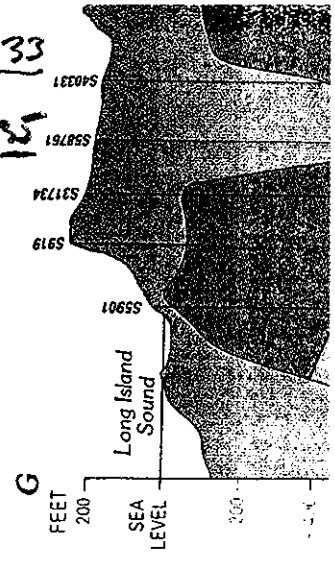
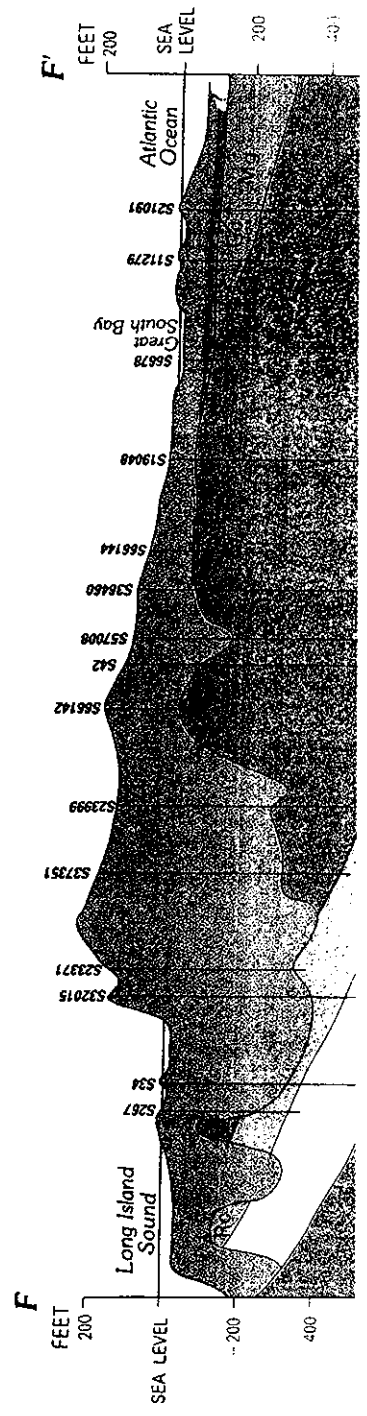

pg 33  
 of 15

# Simulation of Ground-Water Flow and Pumpage in Kings and Queens Counties, Long Island, New York

By Paul E. Misut and Jack Monti, Jr.

---

U.S. GEOLOGICAL SURVEY  
Water-Resources Investigations Report 98-4071

Reference 6

Prepared in cooperation with  
NEW YORK CITY DEPARTMENT OF  
ENVIRONMENTAL PROTECTION



Coram, New York  
1999

pg 35  
of 35

**Table 1. Hydrologic units underlying Kings and Queens Counties, N.Y., and their water-bearing properties as represented by the Long Island regional model**

[gal/min, gallons per minute; ft, feet; ft/d, feet per day. Modified from Doriski and Wilde-Katz, 1983. Modeled hydraulic properties from Buxton and Smolensky, in press]

System	Series	Age	Stratigraphic unit (hydrologic unit names are in parentheses)	Approximate range in thick- ness (feet)	Character	Water-bearing properties, modeled hydraulic conductivity, and anisotropy	
QUATERNARY	Holocene	Post glacial	Holocene (recent) deposits (upper glacial aquifer)	0-40	Beach sand and gravel and dune sand, tan to white; black, brown, and gray bay-bottom deposits of clay and silt; artificial fill. Beach and dune deposits are mostly stratified and well sorted. Fill includes earth and rocks, concrete fragments, ashes, rubbish, and hydraulic fill.	Sandy beds of moderate to high permeability beneath barrier beaches, locally yield fresh or salty water from shallow depths. Clayey and silty beds beneath bays retard salt-water encroachment and confine underlying aquifers.	
			Upper Pleistocene deposits (upper glacial aquifer)	0-300	Till composed of clay, sand, gravel, and boulders, forms Harbor Hill and Ronkonkoma terminal moraines. Outwash consisting mainly of brown fine to coarse sand and gravel, stratified. Interbedded with clays.	Till is poorly permeable. Sand and gravel part of outwash highly permeable; yields of individual wells are as much as 1,700 gal/min. Specific capacities of wells as much as 109 gal/min per foot of drawdown. Water fresh except near shorelines. Horizontal hydraulic conductivity: 20-80 ft/d (moraine), 200-300 ft/d (outwash). Horizontal to vertical anisotropy is 10:1. Specific yield is 0.25 (moraine), 0.3 (outwash).	
	Pleistocene	Wisconsinan		unconformity	0-40	Clay and silt, gray and grayish green; some lenses of sand and gravel. Contains shells, foraminifera, and peat. Altitude of top of unit about 20 ft below sea level. Interbedded with outwash in southern part of area.	Relatively impermeable confining unit. Retards saltwater encroachment in shallow depths. Confines water in underlying outwash deposits when present.
				Sangamon interglaciation	Gardiners Clay	0-150	Clay and silt, grayish-green; some lenses of sand and gravel. Contains lignitic material, shells, glauconite, foraminifera, and diatoms. Interglacial deposit. Altitude of surface 50 ft or more below sea level.
	Illinoian(?)	unconformity	Jameco Gravel (Jameco aquifer)		0-200	Sand, coarse, granule to cobble gravel, generally dark brown and dark gray. A stream deposit in a valley cut in Matawan Group-Magothy Formation undifferentiated deposits. Buried valley of ancestral Hudson River.	Highly permeable. Yields as much as 1,500 gal/min to individual wells. Specific capacities as high as 135 gal/min per foot of drawdown. Contains water under artesian pressure. Water commonly has high iron content and is salty near shoreline. Horizontal hydraulic conductivity is 200-300 ft/d. Horizontal to vertical anisotropy is 10:1. Specific storage is $1 \times 10^{-6}$ per ft.

**CALCULATION COVER SHEET**

Client: NYSDEC Project Name: Kliegman Bros

Project / Calculation Number: 111 74 770

Title: Hydraulic Containment of the Dissolved-Phase PCE Contamination - Part 2

Total number of pages (including cover sheet): 11 (10 + cover)

Total number of computer runs: 0

Prepared by: Marek Ostrowski

Date: 8/22/06

Checked by: Amy Mont

Date: 9/22/06

Description and Purpose: To present options for locations of extraction wells  
and corresponding extraction rates and dimensions of capture zones.

\_\_\_\_\_  
\_\_\_\_\_  
\_\_\_\_\_

Design bases / references / assumptions: Method developed in Part 1 calculation.

\_\_\_\_\_  
\_\_\_\_\_  
\_\_\_\_\_

Remarks / conclusions: See Summary, Section 5, and plots on pages 8, 9 and 10.

\_\_\_\_\_  
\_\_\_\_\_  
\_\_\_\_\_

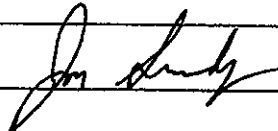
Calculation Approved by:  10/2/06  
Project Manager / Date

Revision No:	Description of Revisions	Approved by:
_____	_____	_____
_____	_____	_____
_____	_____	_____

Project Manager / Date



URS

PAGE 1 OF 10

JOB NO. 111 74 770

MADE BY: *MW*  
CHKD. BY: *AMM*

DATE: *8/22/06*  
DATE: *9/22/06*

PROJECT: NYSDEC, Kliegman Bros. Site

SUBJECT: Hydraulic Containment of the Dissolved-Phase PCE Contamination - Part 2

## 1. PURPOSE

In the calculation entitled *Hydraulic Containment of the Dissolved-Phase PCE Contamination - Part 1*, a relationship was developed between the extraction rate of containment well(s) and the dimensions of the capture zone intended to control the plume identified at the Kliegman Brothers site. In this Part 2 of the calculation, several actual locations for the extraction well(s) will be selected, and the extraction rates required to control the plume will be estimated. Corresponding capture zones will be presented graphically.

## 2. GENERAL

See calculation *Hydraulic Containment of the Dissolved-Phase PCE Contamination - Part 1* for the description of the problem and the development of the method defining capture zones. Two targets for hydraulic containment are containment areas enclosed by 1,000-ppb and 10,000-ppb isoconcentration lines.

## 3. METHODOLOGY

Plot on page 13 of the *Hydraulic Containment of the Dissolved-Phase PCE Contamination - Part 1* shows the relationship between the extraction rate and the lateral and downgradient dimensions of the capture zone. The plot is reproduced here on page 7.

In this calculation, the first step is to select locations of the containment well. The second step is to determine the downgradient distance from the well to the limit of the area to be contained (note: the distance is increased by 100 feet for the purpose of this calculation to provide a safety factor). This distance determines the minimum extraction rate that will achieve containment. Determination of this minimum extraction rate from the plot on page 7 is the third step of the process. In the fourth step, the lateral extent of the capture zone is determined based on the extraction rate established in step three. Finally, the well location and the capture zone are sketched on the map of the site.

URS

PAGE 2 OF 10

JOB NO. 111 74 770

MADE BY: MO DATE: 9/22/06

CHKD. BY: AMM DATE: 9/22/06

PROJECT: NYSDEC, Kliegman Bros. Site

SUBJECT: Hydraulic Containment of the Dissolved-Phase PCE Contamination - Part 2

When the location of the well that will contain the plume at the lowest possible extraction rate is to be determined, the lateral dimension of the capture zone is determined first, based on the plume width near the leading edge. From that, the downgradient extent of the capture zone is calculated, which determines the well location.

In this calculation it is assumed that 1,000 gpm is the upper limit of well capacity. Even though the aquifer should be able to provide higher flows to the well, turbulent losses at the well screen associated with these flow rates could be large. This may limit the actual well capacities. Therefore, if greater extraction rates greater than 1,000 gpm are needed, multiple wells are assumed.

#### 4. CALCULATIONS

Well located at Kliegman property, containing the 1,000-ppb area

From the site map on page 8, the distance between the well and the downgradient limit of the 1,000-ppb area is approximately 900 ft. Use 1,000 ft. The extraction rate required to develop the downgradient extent of capture zone of 1,000 ft is 1,800 gpm (from the plot on page 7 of this calculation). The lateral extent of capture zone for the 1,800-gp extraction rate is 3,100 ft (plot on page 7).

Note that an extraction rate of 1,800 gpm is very high, and it may be not practical for a single well. Here, two wells are assumed, placed in close proximity.

- Two wells
- Wells at Kliegman Bros. property
- Total extraction rate 1,800 gpm
- Downgradient extent of capture zone of 1,000 ft
- Lateral extent of 3,100 ft
- See sketch on page 8

URS

PAGE 3 OF 10

JOB NO. 111 74 770

MADE BY: MO DATE: 9/22/06  
CHKD. BY: AMM DATE: 9/22/06

PROJECT: NYSDEC, Kliegman Bros. Site

SUBJECT: Hydraulic Containment of the Dissolved-Phase PCE Contamination - Part 2

Well located at Kliegman property, containing the 10,000-ppb area

From the site map on page 8, the distance between the well and the downgradient limit of the 10,000-ppb area is approximately 550 ft. Use 650 ft. The extraction rate required to develop the downgradient extent of capture zone of 650 ft is 1,200 gpm (from the plot on page 7 of this calculation). The lateral extent of capture zone for the 1,200-gp extraction rate is 2,000 ft (plot on page 7).

Note that an extraction rate of 1,200 gpm is very high, and it may be not practical for a single well. Here, two wells are assumed, placed in close proximity.

- Two wells
- Wells at Kliegman Bros. property
- Total extraction rate 1,200 gpm
- Downgradient extent of capture zone of 650 ft
- Lateral extent of 2,000 ft
- See sketch on page 8

#### Well location near Edsall Ave

This location is effectively the same with respect to the downgradient extent of capture zone as the location at the Kliegman property. Therefore, the same extraction rates are required. Because lateral extent of capture zones at those extraction rates is far greater than required, the fact that the Edsall Ave location is shifted laterally from the Kliegman location does not affect the analysis. Capture zones are essentially the same as those for the Kliegman location.

#### Well located near existing monitoring well MW-14D, containing the 1,000-ppb area

From the site map on page 9, the distance between the well and the downgradient limit of the 10,000-ppb area is approximately 700 ft. Use 800 ft. The extraction rate required to develop the downgradient extent of capture zone of 800 ft is 1,450 gpm (from the plot on page 7 of this calculation). The lateral extent of capture zone for the 1,450-gp extraction rate is 2,500 ft (plot on page 7).

URS

PAGE 4 OF 10

JOB NO. 111 74 770

MADE BY: Mo DATE: 9/22/06  
CHKD. BY: AMM DATE: 9/22/06

PROJECT: NYSDEC, Kliegman Bros. Site

SUBJECT: Hydraulic Containment of the Dissolved-Phase PCE Contamination - Part 2

Note that an extraction rate of 1,450 gpm is very high, and it may be not practical for a single well. Here, two wells are assumed, placed in close proximity.

- Two wells
- Wells near existing well MW-14D
- Total extraction rate 1,450 gpm
- Downgradient extent of capture zone of 800 ft
- Lateral extent of 2,500 ft
- See sketch on page 9

Well located near existing monitoring well MW-14D, containing the 10,000-ppb area

From the site map on page 9, the distance between the well and the downgradient limit of the 10,000-ppb area is approximately 250 ft. Use 350 ft. The extraction rate required to develop the downgradient extent of capture zone of 350 ft is 600 gpm (from the plot on page 7 of this calculation). The lateral extent of capture zone for the 600-gpm extraction rate is 1,000 ft (plot on page 7).

- One well
- Well near existing well MW-14D
- Extraction rate 600 gpm
- Downgradient extent of capture zone of 350 ft
- Lateral extent of 1,000 ft
- See sketch on page 9

Lowest extraction rate containing the 1,000-ppb area

From the site map on page 10, lateral dimension of the 1,000-ppb area near the leading edge is approximately 550 ft. Use 650 ft. The extraction rate required to develop the lateral extent of capture zone of 650 ft is 400 gpm (from the plot on page 7 of this calculation). The downgradient extent of capture zone for the 400-gp extraction rate is 200 ft (plot on page 7). Therefore, this well must be placed less than 200 ft from the leading edge. Say, 100 ft.

URS

PAGE 5 OF 10

JOB NO. 111 74 770

MADE BY: mo DATE: 8/22/06

CHKD. BY: AMM DATE: 9/22/06

PROJECT: NYSDEC, Kliegman Bros. Site

SUBJECT: Hydraulic Containment of the Dissolved-Phase PCE Contamination - Part 2

- One well
- Well location shown on page 10
- Extraction rate 400 gpm
- Downgradient extent of capture zone of 200 ft
- Lateral extent of 650 ft

#### Lowest extraction rate containing the 10,000-ppb area

From the site map on page 10, lateral dimension of the 10,000-ppb area near the leading edge is approximately 300 ft. Use 400 ft. The extraction rate required to develop the lateral extent of capture zone of 400 ft is 250 gpm (from the plot on page 7 of this calculation). The downgradient extent of capture zone for the 250-gp extraction rate is 150 ft (plot on page 7). Therefore, this well must be placed less than 150 ft from the leading edge. Say, 100 ft.

- One well
- Well location shown on page 10
- Extraction rate 250 gpm
- Downgradient extent of capture zone of 150 ft
- Lateral extent of 400 ft

## 5. SUMMARY

When extraction wells are located at the Kliegman Bros. Property, or at Edsall Ave, the total extraction rate required to contain the 1,000-ppb area is 1,800 gpm. Two wells would likely be required to obtain this extraction rate. When the 10,000-ppb area needs to be contained, two wells would be required, extracting total of 1,200 gpm.

When extraction wells are located near the existing well MW-14D, the total extraction rate required to contain the 1,000-ppb area is 1,450 gpm. Two wells would likely be required to obtain this extraction rate. When the 10,000-ppb area needs to be contained, one well would be required, extracting 600 gpm.

URS

PAGE 6 OF 10

JOB NO. 111 74 770

MADE BY: *mo* DATE: *8/22/06*

CHKD. BY: *AMM* DATE: *9/22/06*

PROJECT: NYSDEC, Kliegman Bros. Site

SUBJECT: Hydraulic Containment of the Dissolved-Phase PCE Contamination - Part 2

The lowest extraction rate that would be effective in containing the 1,000-ppb plume is 400 gpm. One well, located approximately 100 ft from the southern limit of the 1,000-ppb area would be required. Similarly, one well would be required to develop the lowest extraction rate effective in containing the 10,000-ppb area. The extraction rate of the well would be 250 gpm. The well would have to be located approximately 100 ft from the southern limit of the 10,000-ppb area.

Note that the above calculations pertain to wells that are fully penetrating, or penetrating a significant fraction of the saturated thickness of the aquifer, so that they intercept the flow from the entire saturated thickness. The lowest effective extraction rates of 400 gpm and 250 gpm, respectively for the 1,000-ppb and 10,000-ppb areas, could be decreased by using partially penetrating wells, placed close to the leading edge of the plume. In Part 1 of the hydraulic containment calculation, these lowest effective rates were preliminarily estimated at approximately 200 gpm and 100 gpm, respectively for the 1,000-ppb and 10,000-ppb areas. This option will be investigated in more detail in a subsequent calculation.

Kliegman Bros.  
 Lateral and Downgradient Extent of Capture Zone as a Function of  
 Extraction Rate

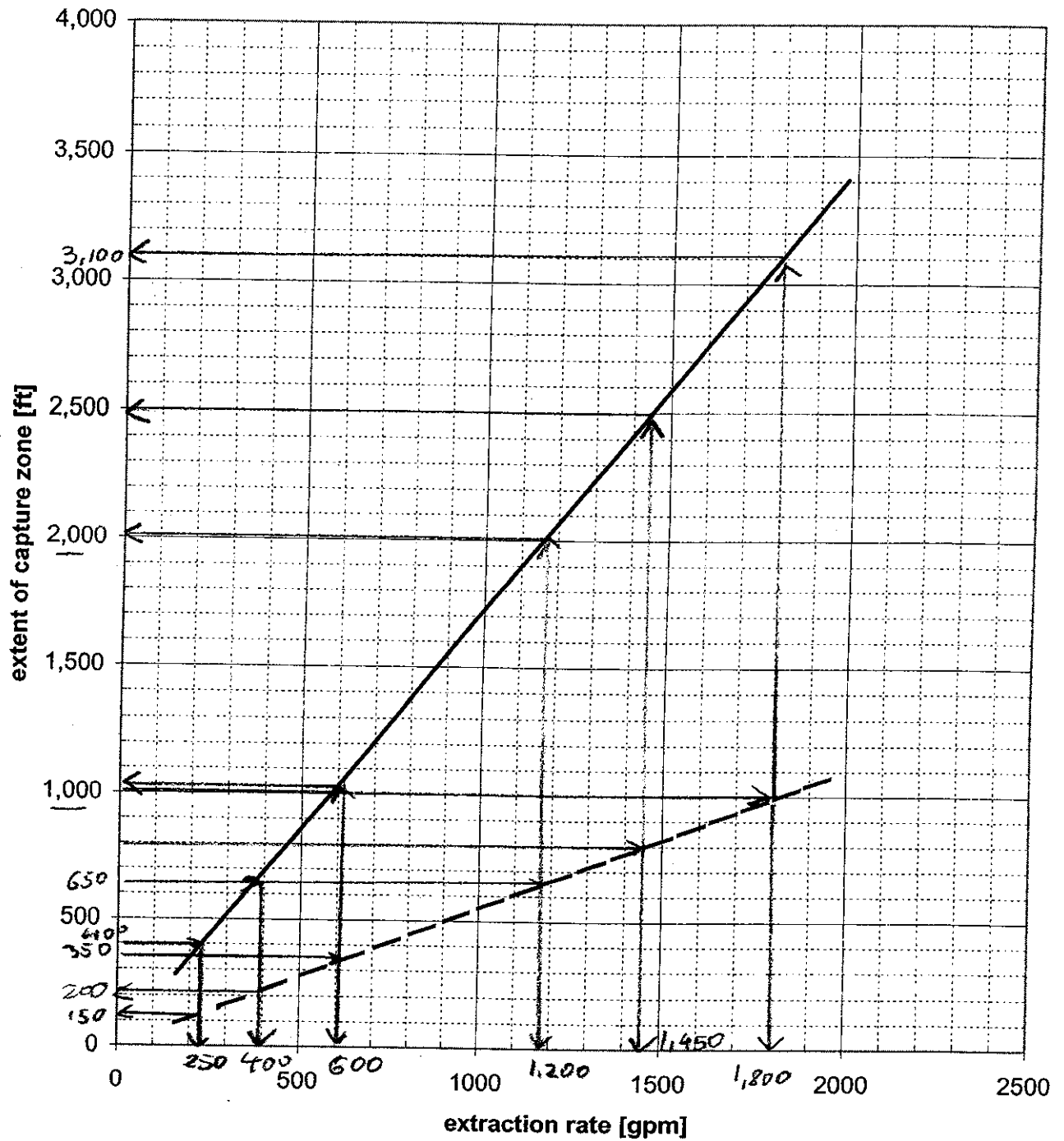

— lateral - - downgradient

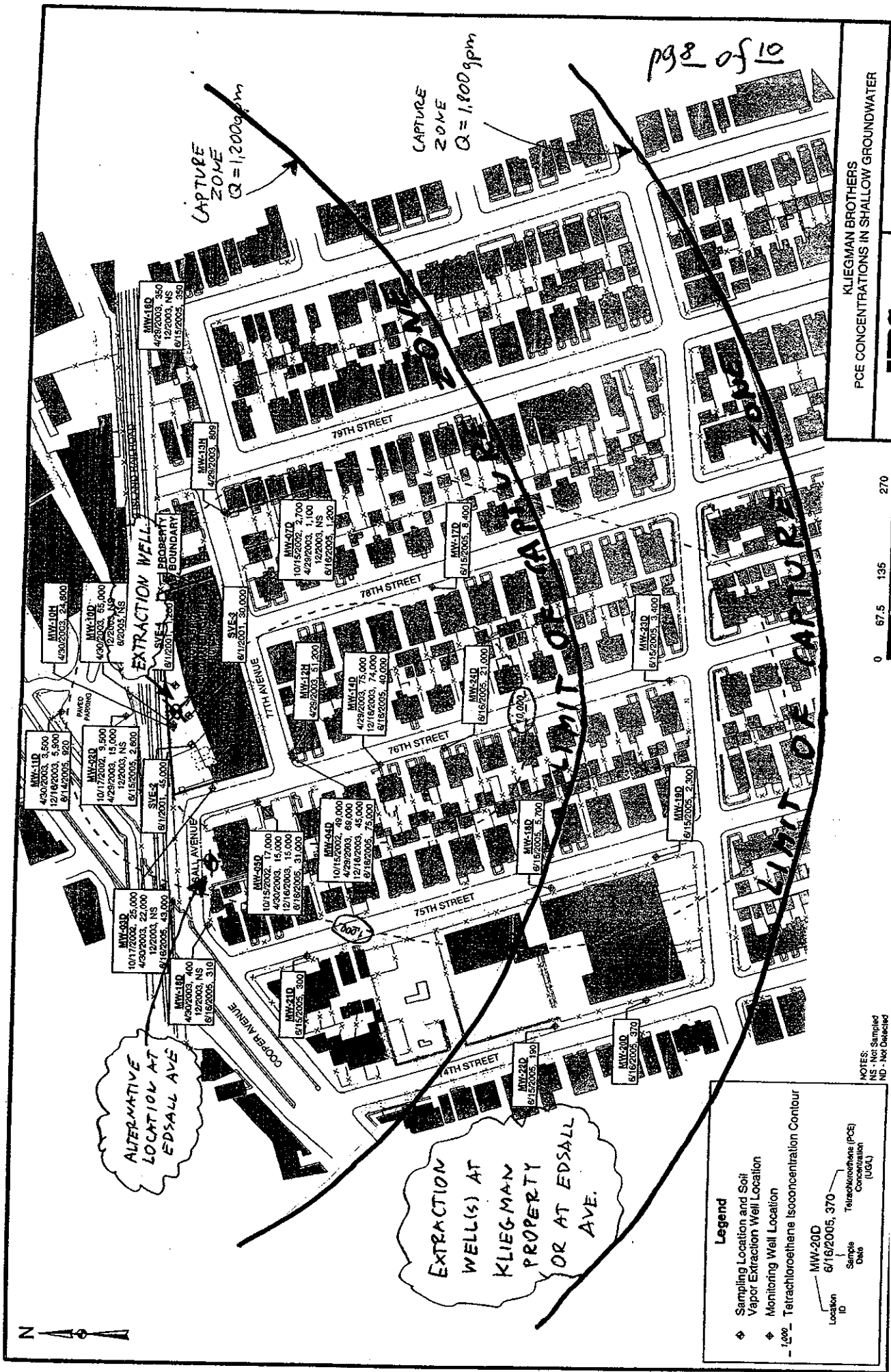

0 67.5 135 270

**Legend**

- ◆ Sampling Location and Soil Vapor Extraction Well Location
- ◆ Monitoring Well Location
- 100- Tetrachloroethane Isoconcentration Contour

Location ID      MW-200  
 Sample Date      8/16/2005, 370  
 Tetrachloroethane (PCE) Concentration (UG/L)

NOTES:  
 NS - Not Sampled  
 ND - Not Detected

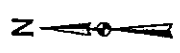





67.5 135 270

**Legend**

- ◆ Sampling Location and Soil Vapor Extraction Well Location
- ◆ Monitoring Well Location
- 7.00- Tetrachloroethene isochlorous Contour

Location ID	Sample Date	Tetrachloroethene (PCE) Concentration (UG/L)
MW-20D	6/16/2005, 370	

NOTES:  
NS - Not Sampled  
ND - Not Detected

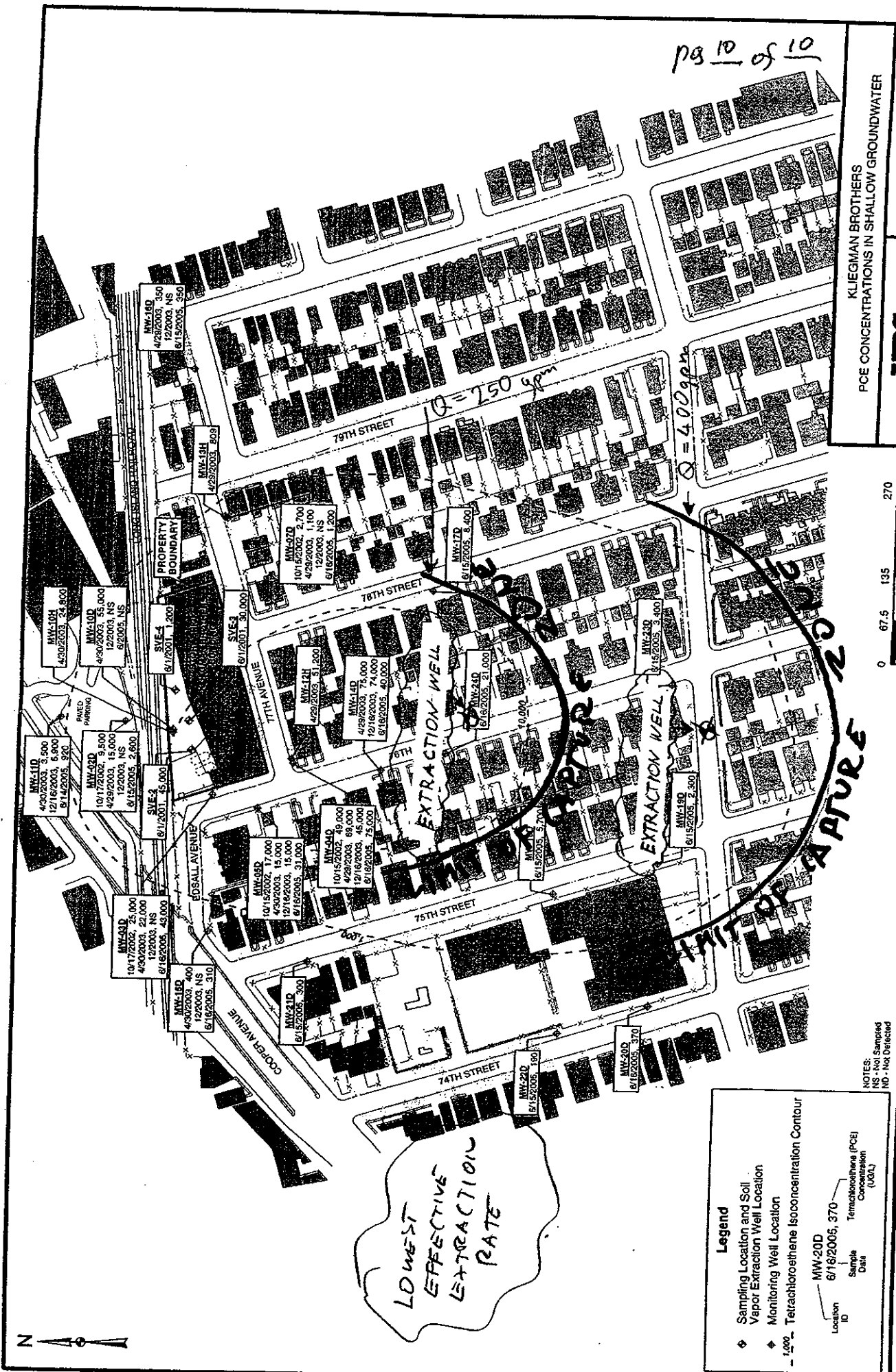

**Legend**

- ◆ Sampling Location and Soil Vapor Extraction Well Location
- ◆ Monitoring Well Location
- - - 1,000 - Tetraachloroethene Isoconcentration Contour

Location ID: MW-20D  
 Sample Date: 8/16/2005, 370  
 Tetraachloroethene (PCE) Concentration (UG/L)

NOTES:  
NS - Not Sampled  
ND - Not Detected

URS

77 Goodell Street  
Buffalo, New York 14203

(716) 856-5636

# CALCULATION COVER SHEET

Client: NYSDEC Project Name: Kliegman Bros

Project / Calculation Number: 111 74 770

Title: Hydraulic Containment of the Dissolved-Phase PCE Contamination - Part 3

Total number of pages (including cover sheet): 36 (35 + cover)

Total number of computer runs: 0

Prepared by: Marek Ostrowski

Date: Oct 4, 2006

Checked by: ROBERT PIUREK

Date: 10/4/06

Description and Purpose: To evaluate the feasibility of controlling the dissolved-phase contamination by means of hydraulic containment, using shallow, partially-penetrating extraction wells.

Design bases / references / assumptions: Theory of wells in uniform flow is used. Aquifer thickness assumed to be infinite. Local hydraulic gradient is not well defined, the regional value is used.

Remarks / conclusions: See Section 7 SUMMARY for details. See page 7 for well locations.  
To contain the 10,000-ppb are, one well is sufficient, extracting 150 gpm.  
To contain the 1,000-ppb are, two wells are required, each extracting 150 gpm (total 300 gpm).  
Wells would have to placed approximately 100 ft from the downgradient limit of areas that must be contained.

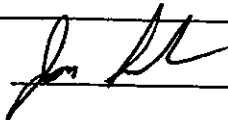
Calculation Approved by:  10/5/06  
Project Manager / Date

Revision No:	Description of Revisions	Approved by:
_____	_____	_____
_____	_____	_____
_____	_____	_____

Project Manager / Date

MADE BY: *pro* DATE: 10/4/06  
CHKD BY: *RSP* DATE: 10/4/06

PROJECT: NYSDEC, Kliegman Bros. Site

SUBJECT: Hydraulic Containment of the Dissolved-Phase PCE Contamination -- Part 3

## 1. PURPOSE

Part 1 and Part 2 of this series of calculations describe the possible strategies for containing the plume of dissolved PCE contamination identified at the Kliegman Bros. site. Both Part 1 and Part 2 emphasize fully penetrating extraction wells, only briefly mentioning the partially penetrating wells. In this Part 3 of the calculation, partially penetrating wells are discussed in more detail. The purpose of this calculation is to evaluate locations and extraction rates of partially penetrating wells for the purpose of containing the plume.

## 2. GENERAL

Site features and extent of contamination are described in *Hydraulic Containment of the Dissolved-Phase PCE Contamination -- Part 1*. Hydraulic containment is investigated for two target areas: an area encompassed within the 1,000-ppb isoconcentration line, and an area encompassed within the 10,000-ppb isoconcentration line. Shallow partially penetrating extraction wells are considered.

## 3. METHOD

The assessment is performed utilizing the approach of capture zones of wells placed in the uniform flow of ground water, as described in reference 1.

Terms used in calculations are defined below:

A -	Anisotropy factor ( $K_{\text{vert}}/K$ ), [-]
b -	Thickness of aquifer, [L]
d -	Depth from water table to top of screen, [L]
I -	Regional hydraulic gradient, [-]
K -	Horizontal hydraulic conductivity, [L/T]
L -	Length of screen, [L]
Q (or $Q_w$ ) -	Well extraction rate, [L <sup>3</sup> /T]
$s_w$ -	Drawdown at the face of extraction well, [L]
$X_{\text{cap}}$ -	Downgradient extent of well capture zone, [L]
$\eta$ -	Effective porosity of aquifer
$\theta$ -	Counterclockwise angle between positive x axis and flow direction, [-]

The velocity field created within the aquifer by the combination of the uniform flow and a group of M pumping wells is described by equations 17a through 17c of reference 1. In this calculation, the capture zones are investigated at the aquifer surface; therefore,  $z = 0$  and only the first two equations are relevant. Only the surface extent of capture zone is of interest because the dissolved-phase contamination is believed to be very shallow within most of the plume (less than top 30 ft of the saturated thickness). All wells are assumed to be shallow, straddling the water table; therefore  $d_i = 0$ . The saturated thickness of the aquifer is approximately 200 ft, the wells are assumed to penetrate only on the order of 10% of that thickness. Therefore, the system is approximated as wells in an infinitely thick aquifer. This is conservative, as creating a given size capture zone in an infinitely thick aquifer requires a higher flow than creating the same capture zone in a finite-thickness aquifer. For an infinitely thick aquifer,  $n = 0$  (one real well and one image well reflected around the upper boundary).

MADE BY: *mo*  
CHKD BY: *RSP*DATE: 10/4/06  
DATE: 10/4/06

PROJECT: NYSDEC, Kliegman Bros. Site

SUBJECT: Hydraulic Containment of the Dissolved-Phase PCE Contamination - Part 3

Equations 17a and 17b are simplified to reflect this situation (see pages ~~17~~ <sup>20 22</sup> to ~~18~~). The resulting velocity field at the aquifer surface is:

$$v_x = \frac{KI}{\eta} \cos \theta - \frac{1}{2\pi\sqrt{A}\eta} \sum_{i=1}^M \frac{Q_i(x-x_i)}{\sqrt{(x-x_i)^2 + (y-y_i)^2 + \frac{L^2}{A}[(x-x_i)^2 + (y-y_i)^2]}}$$

$$v_y = \frac{KI}{\eta} \sin \theta - \frac{1}{2\pi\sqrt{A}\eta} \sum_{i=1}^M \frac{Q_i(y-y_i)}{\sqrt{(x-x_i)^2 + (y-y_i)^2 + \frac{L^2}{A}[(x-x_i)^2 + (y-y_i)^2]}}$$

Capture zones are delineated by tracking particles inserted in this velocity field. The same numerical tracking method is used as is outlined in reference 1, page 635. A spreadsheet table is used to perform the calculations. The spreadsheet is verified using two approaches.

First, it is noted that the location of the stagnation point created by pumping from a single well can be calculated analytically. See pages ~~16~~ <sup>16</sup> to ~~18~~.

$$X_{cap} = \sqrt{\frac{-\frac{L^2}{A} + \sqrt{\left(\frac{L^2}{A}\right)^2 + \left(\frac{Q_w}{\pi KI \sqrt{A}}\right)^2}}{2}}$$

For a given set of aquifer/well parameters, the location  $X_{cap}$  of the stagnation point is calculated as specified above. Then, the capture zone is plotted using the spreadsheet. The location of stagnation point obtained from the plot is compared to the calculated location  $X_{cap}$ . The two locations should be the same. This is the case - see page ~~22~~ <sup>23</sup>.

Second, it is noted that for a single zero-penetration well (i.e. a point sink) in an isotropic aquifer, the half-width of the capture zone at the line of well can be calculated analytically. See equation 23 of reference 1.

$$r = \sqrt{\frac{Q}{\pi KI}}$$

The location of the stagnation point  $X_{cap}$  can also be calculated analytically, as shown above. Therefore, the capture zone of a zero-penetration well can be defined by two points, both calculated analytically. For a given set of aquifer/well parameters, the half-width "r" and the stagnation point " $X_{cap}$ " are thus calculated. Then, for the same set of parameters, the spreadsheet is used to plot the capture zone. The half-width and the stagnation point of the plotted capture zone are compared to the calculated values. See page ~~13~~ <sup>24</sup>. Both sets of values match. Note that the penetration of 1 foot was used in the spreadsheet table to approximate a zero-penetration well.

MADE BY: *MV* DATE: *10/4/06*  
CHKD BY: *RBP* DATE: *10/4/06*PROJECT: NYSDEC, Kliegman Bros. Site  
SUBJECT: Hydraulic Containment of the Dissolved-Phase PCE Contamination – Part 3

The two types of verification presented above apply to a single well. The spreadsheet, however, is constructed to handle up to seven wells. The workings of the superposition are verified on pages 12 and 14. First, the capture zone of a single well is plotted (page 12). Second, all seven wells are placed at the same location as the single well, and the sum of their discharges is made to be equal to the discharge of the single well. The capture zone of this system is plotted on page 14. If the superposition works correctly, the two capture zones on pages 12 and 14 should be identical, as they are.

An extraction rate of a well placed in an infinitely thick aquifer as a function of the well drawdown is derived on pages 18 to 19, using methods presented in reference 1.

$$Q_w = \frac{s_w 4\pi KL}{\ln \frac{\sqrt{r_w^2 + \frac{L^2}{A} + \frac{L}{\sqrt{A}}}}{\sqrt{r_w^2 + \frac{L^2}{A} - \frac{L}{\sqrt{A}}}}}$$

#### 4. PARAMETERS

The same parameters are used as those utilized in Parts 1 and 2 of this series of calculations. Only the thickness of the aquifer – approximately 200 ft – is not used, as in this calculation the aquifer is assumed to be of infinite vertical extent.

##### Aquifer Properties (K, A, I)

From page 5 of the Part 1 calculation:

$$K = 283 \text{ ft/d } (1 \cdot 10^{-1} \text{ cm/s})$$

$$I = 0.001$$

Based on Table 1 of reference 6 from the Part 1 calculation, the typical anisotropy of the aquifer  $K_{\text{horizontal}}/K_{\text{vertical}}$  is 10:1. From that:

$$A = K_{\text{vertical}}/K_{\text{horizontal}} = 1/10 = 0.1$$

However, the size of the capture zone is strongly influenced by this parameter. As “A” increases, the lateral extent of the capture zone decreases. The lateral extent of capture zone is lowest for an isotropic aquifer. Here, in addition to  $A = 0.1$ , the case of an isotropic aquifer is investigated.

Case 1:  $A = 0.1$

Case 2:  $A = 1.0$

MADE BY: *mo* DATE: 10/4/06  
CHKD BY: *RC* DATE: 10/4/06PROJECT: NYSDEC, Kliegman Bros. Site  
SUBJECT: Hydraulic Containment of the Dissolved-Phase PCE Contamination - Part 3**Well Properties (d, L, r<sub>w</sub>)**

Wells are assumed to straddle the water table; therefore,  $d = 0$ . The well penetration depth is assumed to be  $P = 30$  ft. The submerged screen length at the face of the well is equal to the difference between the penetration depth and well drawdown:

$$L = P - s_w$$

The submerged screen length is variable. It depends on the drawdown developed at the face of the well.

The wells are assumed to be 10-inch diameter:

$$r_w = 10 / 2 = 5 \text{ in}$$

Assume that the depth of water column inside the well must remain at the value of at least 15 ft. This is to accommodate the pump. Based on the  $L_{in-min} = 15$  ft minimum saturated screen length inside the well, well radius of 5 in (0.42 ft), screen open area fraction of  $f_{op} = 0.1$  and the maximum allowable flow velocity  $v = 0.1$  ft/s, the maximum allowable flow rate for this well is:

$$Q_{max} = 2 \pi r_w L_{in} f_{op} v = 2 \pi (0.42) (15) (0.1) (0.1) = 0.4 \text{ ft}^3/\text{s} = 180 \text{ gpm}$$

Assume well efficiency of  $f = 30\%$ . Therefore, the " $L_{in}$ " saturated screen length inside the well indicates that the saturated screen length at the well face is as follows:

$$L_{in} = P - s_w / 0.3 \Rightarrow s_w = 0.3 (P - L_{in})$$

$$L = P - s_w \Rightarrow L = P - 0.3 (P - L_{in}) = 0.7 P + 0.3 L_{in}$$

The condition  $L_{in-min} = 15$  ft defines the maximum drawdown that can be developed at the well face, and the minimum saturated thickness at the well face:

$$s_{w-max} = 0.3 (P - L_{in-min}) = 0.3 (30 - 15) = 4.5 \text{ ft}$$

$$L_{min} = 0.7 P + 0.3 L_{in-min} = 0.7 * 30 + 0.3 * 15 = 25.5 \text{ ft}$$

**Containment area**

Required lateral extents of capture zones are the same as those used in Part 2 for the case of the lowest effective extraction rate (pages 4 and 5 of Part 2 calculation).

$$W_{1,000\text{-ppb}} = 650 \text{ ft}$$

$$W_{10,000\text{-ppb}} = 400 \text{ ft}$$

MADE BY: *AMS* DATE: *10/4/06*  
CHKD BY: *RBA* DATE: *10/4/06*PROJECT: NYSDEC, Kliegman Bros. Site  
SUBJECT: Hydraulic Containment of the Dissolved-Phase PCE Contamination - Part 3

## 5. CALCULATIONS

The highest extraction rate that can be developed by a well corresponds to the highest well drawdown.

$$Q_{w-\max} = \frac{s_{w-\max} 4\pi K L_{\min}}{\ln \frac{\sqrt{r_w^2 + \frac{L_{\min}^2}{A} + \frac{L_{\min}}{\sqrt{A}}}}{\sqrt{r_w^2 + \frac{L_{\min}^2}{A} - \frac{L_{\min}}{\sqrt{A}}}}} = \frac{4.5 \cdot 4\pi \cdot 283 \cdot 25.5}{\ln \frac{\sqrt{0.42^2 + \frac{25.5^2}{0.1} + \frac{25.5}{\sqrt{0.1}}}}{\sqrt{0.42^2 + \frac{25.5^2}{0.1} - \frac{25.5}{\sqrt{0.1}}}}}$$

$$Q_{w-\max} = 408,083 / \ln(161.28/0.0010938) = 34,000 \text{ ft}^3/\text{d} = 180 \text{ gpm}$$

The highest extraction rate that can be obtained from the well (180 gpm) is approximately the same as the highest extraction rate that can be handled by a 15-ft submerged screen (180 gpm). For the purpose of this calculation, assume that the maximum extraction rate from the well that will actually be utilized is 150 gpm.

### Containment of the 10,000-ppb area

The extent of capture zone for a single well extracting  $Q = 150$  gpm in an anisotropic aquifer ( $A = 0.1$ , Case 1) is shown on page 9. Extent of capture zone for  $Q = 150$  gpm and an isotropic aquifer ( $A = 1.0$ , Case 2) is shown on page 11. Results are as follows:

$$\text{Case 1 } Q = 150 \text{ gpm, } A = 0.1 \Rightarrow W_{\text{capture-}A=0.1} = 630 \text{ ft}$$

$$\text{Case 2 } Q = 150 \text{ gpm, } A = 1.0 \Rightarrow W_{\text{capture-}A=1} = 360 \text{ ft}$$

For the anticipated value of aquifer anisotropy of  $A = 0.1$ , the capture zone width of 630 ft at the 150-gpm extraction rate would be sufficient to create a capture zone around the 10,000-ppb area, whose width is 400 ft.

In the conservative case of an isotropic aquifer, the width of the capture zone of a 150-gpm well would be approximately 360 ft, which is 10% less than the required width of 400 ft. This would make the 150-gpm extraction rate only marginally effective. However, a fully isotropic condition in the Upper Glacial aquifer is very unlikely.

A single well extracting 150 gpm appears to be capable of developing the lateral extent of the capture zone of between approximately 360 and 630 ft. The required extent to contain the 10,000-ppb area is 400 ft. The 360-ft capture zone occurs for the isotropic condition, which is much less likely to occur than the anisotropic condition. Therefore, the overall assessment is that a single extraction well pumping at 150 gpm would be sufficient to contain the 10,000-ppb area. The well should be placed approximately 100 ft from the downgradient limit of the 10,000-ppb area.

### Containment of the 1,000-ppb area

For the anticipated value of aquifer anisotropy of  $A = 0.1$ , a single well extracting 150 gpm would create a 630-ft wide capture zone. This is shown on page 9. The required width of containment for the 1,000-ppb area is 650 ft. This would make the single well only marginally effective at the expected anisotropy condition.



MADE BY: *hno* DATE: *10/4/06*  
CHKD BY: *ROR* DATE: *10/4/06*PROJECT: NYSDEC, Kliegman Bros. Site  
SUBJECT: Hydraulic Containment of the Dissolved-Phase PCE Contamination - Part 3

Two wells, each extracting a 150-gpm rate (300-gpm total), in the case of an anisotropic aquifer ( $A = 0.1$ ) would create a 980-ft wide capture zone (page ~~RR~~<sup>13</sup>). This is sufficient to contain the 650-ft wide area of the 1,000-ppb concentration. The same two wells would create a 650-ft capture zone for the conservative case of the isotropic aquifer ( $A = 1$ , page ~~RR~~<sup>15</sup>).

$$\text{Case 1 } Q = 300 \text{ gpm, } A = 0.1 \Rightarrow W_{\text{capture-}A=0.1} = 980 \text{ ft}$$

$$\text{Case 2 } Q = 300 \text{ gpm, } A = 1.0 \Rightarrow W_{\text{capture-}A=1} = 650 \text{ ft}$$

The overall assessment is that two extraction wells, each pumping at 150 gpm (300-gpm total), would be sufficient to contain the 1,000-ppb area. The spacing between the wells is approximately 280 ft. The wells should be placed approximately 100 ft from the downgradient limits of the 1,000-ppb area.

## 6. SUMMARY

One partially-penetrating well, extracting 150-gpm, should be sufficient to create a capture zone required to contain the 10,000-ppb area of the dissolved PCE plume. The well would have to penetrate approximately 30 ft into the water table. Well drawdown would be approximately 5 ft. The well would have to be located within approximately 100 ft from the downgradient limit of the 10,000-ppb area (see page ~~RR~~<sup>7</sup>).

Two such wells should be sufficient to create a capture zone required to contain the 1,000-ppb area of the dissolved PCE plume. The total extraction rate would be 300 gpm (150 gpm each well). The wells would have to be located within approximately 100 ft from the downgradient limit of the 10,000-ppb area (see page ~~RR~~<sup>7</sup>). 1,000

## 7. REFERENCES

1. Determining 3D Capture Zones in Homogeneous Anisotropic Aquifers  
D. Schafer  
Ground Water, July-August 1996



This spreadsheet calculates pathlines of partickles inserted at the surface of the aquifer (z = 0) where several wells are extracting ground water. Conditions are:

- \* homogenous, anisotropic aquifer (K - horiz conductivity, K<sub>z</sub> - vertical cond)
- \* aquifer of infinite thickness (b = infinity)
- \* uniform hydraulic gradient (i - hydraulic gradient, theta - angle between positive x-axis and flow direction, measured counterclockwise)
- \* seven extraction wells (Q<sub>i</sub> - extraction rates, L<sub>i</sub> - penetration depths)
- \* wells straddle the aquifer surface (d<sub>i</sub> = 0)
- \* wells located at points (x<sub>i</sub>, y<sub>i</sub>)
- \* numerical parametrs: n<sub>eff</sub> - dummy aquifer porosity, del l - distance which a partickle is allowed to move in one time step, x<sub>start</sub> & y<sub>start</sub> - initial position of a particle

Velocities calculated per "Determining Capture Zones in Homogeneous, Anisotropic Aquifers", Ground Water, July-August 1996, Vol. 34, No. 4.

$$v_x = (K i / n_{eff}) \cos(\theta) - [1 / 2 \text{PI} \text{SQRT}(A) n_{eff}] \text{EPS} \{Q_i (x - x_i) / [F(x,y)G(x,y)]\}$$

$$v_y = (K i / n_{eff}) \sin(\theta) - [1 / 2 \text{PI} \text{SQRT}(A) n_{eff}] \text{EPS} \{Q_i (y - y_i) / [F(x,y)G(x,y)]\}$$

$$v_z = 0 \text{ (pathlines on the surface of the aquifer)}$$

$$F(x,y) = \text{SQRT}\{(x-x_i)^2 + (y-y_i)^2 + L_i^2/A\}$$

$$G(x,y) = (x-x_i)^2 + (y-y_i)^2$$

- 1) Assume initial position (x,y)
- 2) Calculate velocities v<sub>x</sub> and v<sub>y</sub> at (x,y)
- 3) Calculate the trial position:
 
$$x_t = x + (\text{del } l) [v_x / \text{SQRT}(v_x^2 + v_y^2)]$$

$$y_t = y + (\text{del } l) [v_y / \text{SQRT}(v_x^2 + v_y^2)]$$
- 4) Calculate velociites v<sub>xt</sub> and v<sub>yt</sub> at trial position (x<sub>t</sub>,y<sub>t</sub>)
- 5) Calculate final position:
 
$$x_f = x + (\text{del } l) \{(v_x + v_{xt}) / \text{SQRT}[(v_x + v_{xt})^2 + (v_y + v_{yt})^2]\}$$

$$y_f = y + (\text{del } l) \{(v_y + v_{yt}) / \text{SQRT}[(v_x + v_{xt})^2 + (v_y + v_{yt})^2]\}$$

**Wells:**

Well #	Well ID	Q <sub>i</sub> [gpm]	L <sub>i</sub> [ft <sup>3</sup> /d]	x <sub>i</sub> [ft]	y <sub>i</sub> [ft]
1	EW-01	150	28,873	25.5	0

**Aquifer:**

K = 1.0E-01 cm/sec = 283.46 ft/d  
 A = K<sub>z</sub>/K = 0.1 ← *Case 1, 10,000 ppb area*  
 n<sub>eff</sub> = 0.15  
 i = 0.001  
 phi = 0 deg = 0 rad

**Numerical:**

pathline #	X <sub>start</sub>	Y <sub>start</sub>	del l
1	-500	418	0.6
2	-500	419	0.6
3	-500	-418	0.6
4	-500	-419	0.6

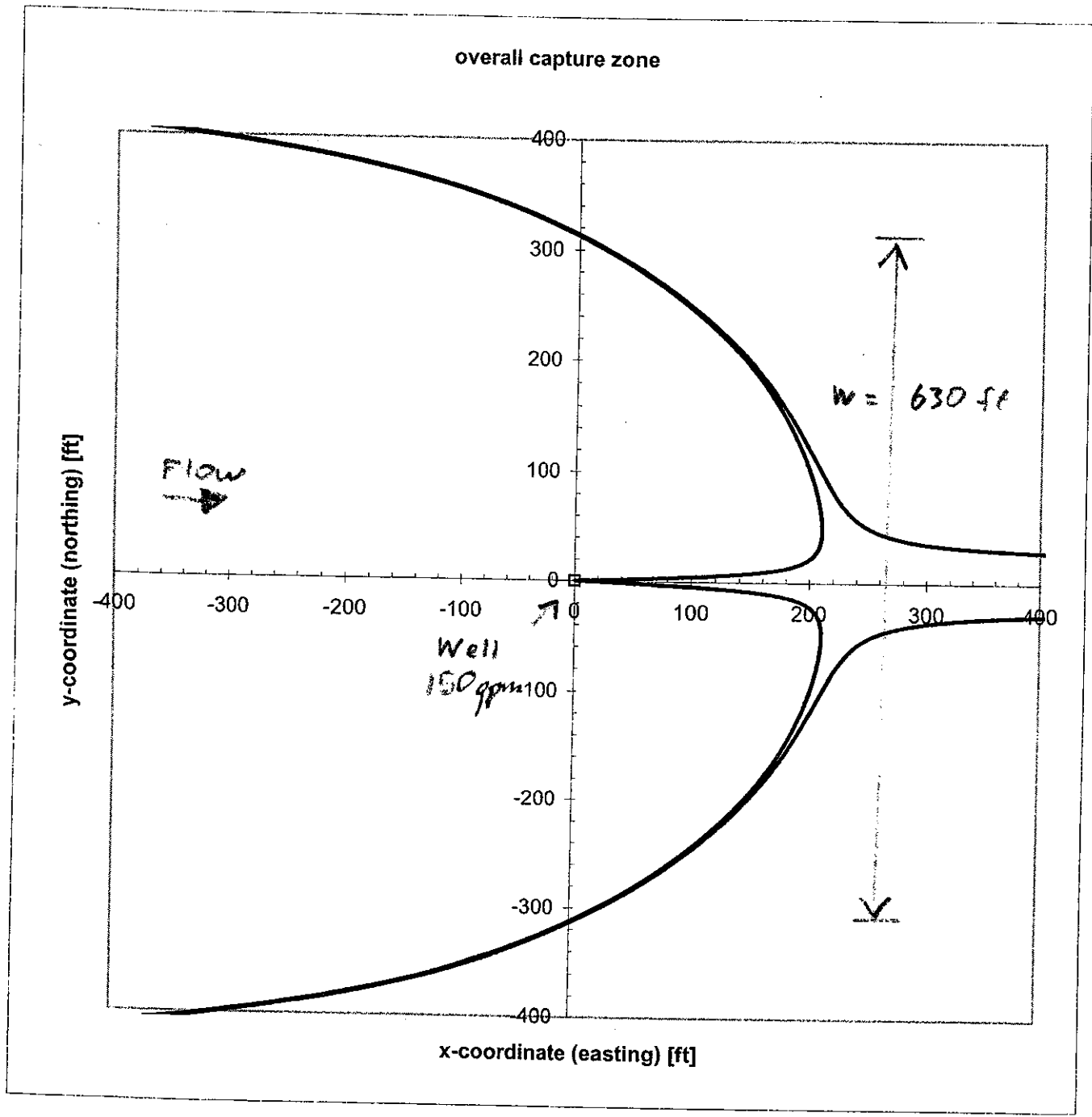

Case 1, 10,000-ppb area  
Required lateral extent  
of capture zone

$$W_{10,000\text{-ppb}} = 400 \text{ ft}$$

This spreadsheet calculates pathlines of parttkles inserted at the surface of the aquifer (z = 0) where several wells are extracting ground water. Conditions are:

- \* homogenous, anisotropic aquifer (K - horiz conductivity, K<sub>z</sub> - vertical cond)
- \* aquifer of infinite thickness (b = infinity)
- \* uniform hydraulic gradient (i - hydraulic gradient, theta - angle between positive x-axis and flow direction, measured counterclockwise)
- \* seven extraction wells (Q<sub>i</sub> - extraction rates, L<sub>i</sub> - penetration depths)
- \* wells straddle the aquifer surface (d<sub>i</sub> = 0)
- \* wells located at points (x<sub>i</sub>, y<sub>i</sub>)
- \* numerical parametrs: n<sub>eff</sub> - dummy aquifer porosity, del l - distance which a parttkle is allowed to move in one time step, x<sub>start</sub> & y<sub>start</sub> - initial position of a particle

Velocities calculated per "Determining Capture Zones in Homogeneous, Anisotropic Aquifers", Ground Water, July-August 1996, Vol. 34, No. 4.

$$v_x = (K i / n_{eff}) \cos(\theta) - [1 / 2 \text{PI} \text{SQRT}(A) n_{eff}] \text{EPS} \{Q_i (x - x_i) / [F(x,y)G(x,y)]\}$$

$$v_y = (K i / n_{eff}) \sin(\theta) - [1 / 2 \text{PI} \text{SQRT}(A) n_{eff}] \text{EPS} \{Q_i (y - y_i) / [F(x,y)G(x,y)]\}$$

v<sub>z</sub> = 0 (pathlines on the surface of the aquifer)

$$F(x,y) = \text{SQRT}\{(x-x_i)^2 + (y-y_i)^2 + L_i^2/A\}$$

$$G(x,y) = (x-x_i)^2 + (y-y_i)^2$$

- 1) Assume initial position (x,y)
- 2) Calculate velocities v<sub>x</sub> and v<sub>y</sub> at (x,y)
- 3) Calculate the trial position:
  - x<sub>t</sub> = x + (del l) [v<sub>x</sub> / SQRT(v<sub>x</sub><sup>2</sup> + v<sub>y</sub><sup>2</sup>)]
  - y<sub>t</sub> = y + (del l) [v<sub>y</sub> / SQRT(v<sub>x</sub><sup>2</sup> + v<sub>y</sub><sup>2</sup>)]
- 4) Calculate velociites v<sub>xt</sub> and v<sub>yt</sub> at trial position (x<sub>t</sub>,y<sub>t</sub>)
- 5) Calculate final position:
  - x<sub>f</sub> = x + (del l) {(v<sub>x</sub> + v<sub>xt</sub>) / SQRT[(v<sub>x</sub> + v<sub>xt</sub>)<sup>2</sup> + (v<sub>y</sub> + v<sub>yt</sub>)<sup>2</sup>]}
  - y<sub>f</sub> = y + (del l) {(v<sub>y</sub> + v<sub>yt</sub>) / SQRT[(v<sub>x</sub> + v<sub>xt</sub>)<sup>2</sup> + (v<sub>y</sub> + v<sub>yt</sub>)<sup>2</sup>]}

**Wells:**

Well #	Well ID	Q <sub>i</sub> [gpm]	L <sub>i</sub> [ft <sup>3</sup> /d]	x <sub>i</sub> [ft]	y <sub>i</sub> [ft]
1	EW-01	150	28,873	25.5	0

**Aquifer:**

K = 1.0E-01 cm/sec = 283.46 ft/d  
 A = K<sub>z</sub>/K = 1  
 n<sub>eff</sub> = 0.15  
 i = 0.001  
 phi = 0 deg = 0 rad

*Case 2, 10,000-ppb area*

**Numerical:**

pathline #	x <sub>start</sub>	y <sub>start</sub>	del l
1	-500	245	0.5
2	-500	247	0.5
3	-500	-245	0.5
4	-500	-247	0.5

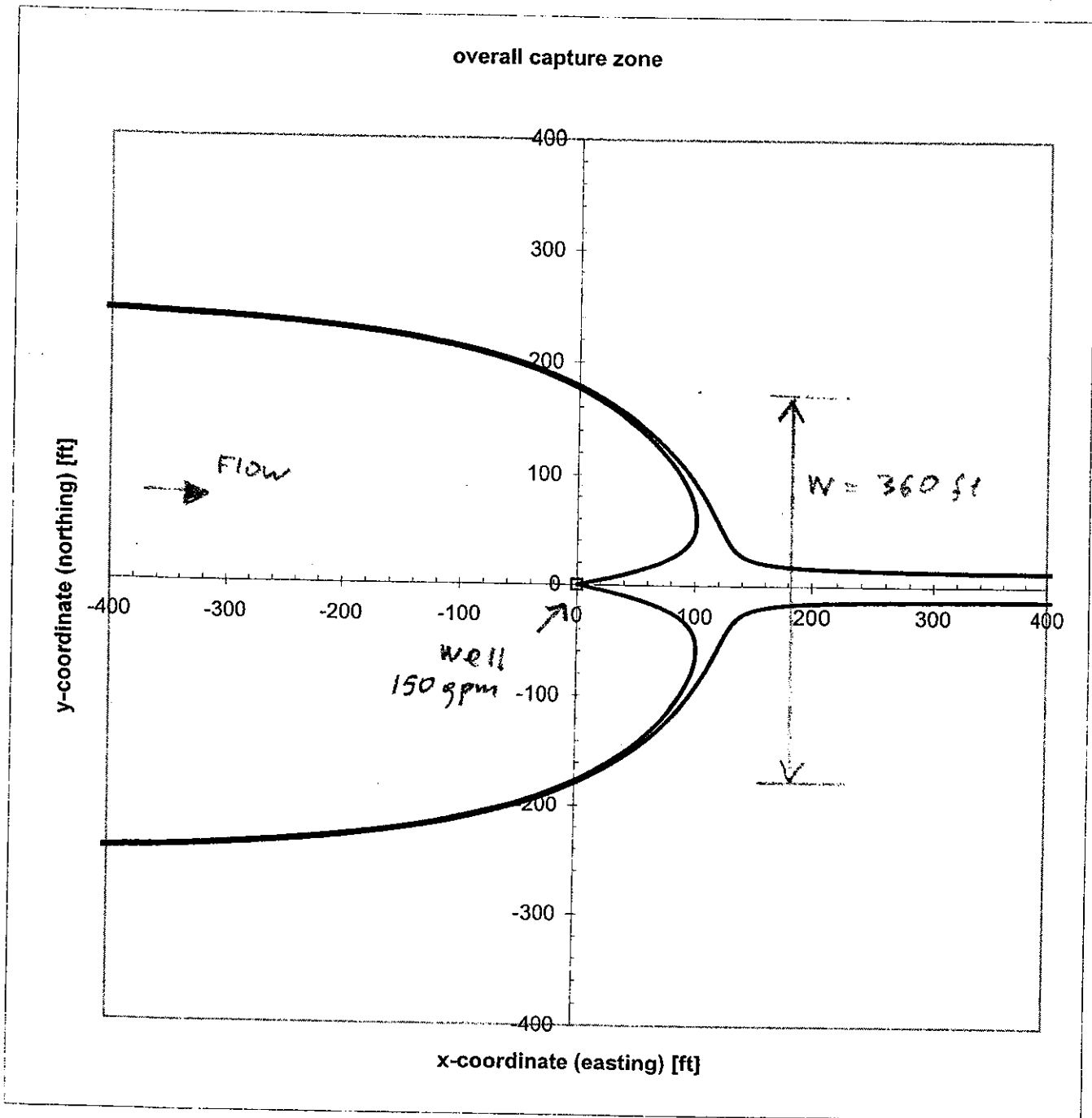

Case 2, 10,000-ppb area

Required lateral extent  
of capture zone

10,000-ppb = 400 ft

This spreadsheet calculates pathlines of partickles inserted at the surface of the aquifer (z = 0) where several wells are extracting ground water. Conditions are:

- \* homogenous, anisotropic aquifer (K - horiz conductivity, K<sub>z</sub> - vertical cond)
- \* aquifer of infinite thickness (b = infinity)
- \* uniform hydraulic gradient (i - hydraulic gradient, theta - angle between positive x-axis and flow direction, measured counterclockwise)
- \* seven extraction wells (Q<sub>i</sub> - extraction rates, L<sub>i</sub> - penetration depths)
- \* wells straddle the aquifer surface (d<sub>i</sub> = 0)
- \* wells located at points (x<sub>i</sub>, y<sub>i</sub>)
- \* numerical parametrs: n<sub>eff</sub> - dummy aquifer porosity, del l - distance which a partickle is allowed to move in one time step, x<sub>start</sub> & y<sub>start</sub> - initial position of a particle

Velocities calculated per "Determining Capture Zones in Homogeneous, Anisotropic Aquifers", Ground Water, July-August 1996, Vol. 34, No. 4.

$$v_x = (K i / n_{eff}) \cos(\theta) - [1 / 2 \text{PI} \text{SQRT}(A) n_{eff}] \text{EPS} \{Q_i (x - x_i) / [F(x,y)G(x,y)]\}$$

$$v_y = (K i / n_{eff}) \sin(\theta) - [1 / 2 \text{PI} \text{SQRT}(A) n_{eff}] \text{EPS} \{Q_i (y - y_i) / [F(x,y)G(x,y)]\}$$

$$v_z = 0 \text{ (pathlines on the surface of the aquifer)}$$

$$F(x,y) = \text{SQRT}\{(x-x_i)^2 + (y-y_i)^2 + L_i^2/A\}$$

$$G(x,y) = (x-x_i)^2 + (y-y_i)^2$$

- 1) Assume initial position (x,y)
- 2) Calculate velocities v<sub>x</sub> and v<sub>y</sub> at (x,y)
- 3) Calculate the trial position:
  - x<sub>t</sub> = x + (del l) [v<sub>x</sub> / SQRT(v<sub>x</sub><sup>2</sup> + v<sub>y</sub><sup>2</sup>)]
  - y<sub>t</sub> = y + (del l) [v<sub>y</sub> / SQRT(v<sub>x</sub><sup>2</sup> + v<sub>y</sub><sup>2</sup>)]
- 4) Calculate velociites v<sub>xt</sub> and v<sub>yt</sub> at trial position (x<sub>t</sub>,y<sub>t</sub>)
- 5) Calculate final position:
  - x<sub>f</sub> = x + (del l) [(v<sub>x</sub> + v<sub>xt</sub>) / SQRT[(v<sub>x</sub> + v<sub>xt</sub>)<sup>2</sup> + (v<sub>y</sub> + v<sub>yt</sub>)<sup>2</sup>]]
  - y<sub>f</sub> = y + (del l) [(v<sub>y</sub> + v<sub>yt</sub>) / SQRT[(v<sub>x</sub> + v<sub>xt</sub>)<sup>2</sup> + (v<sub>y</sub> + v<sub>yt</sub>)<sup>2</sup>]]

**Wells:**

Well #	Well ID	Q <sub>i</sub> [gpm]	L <sub>i</sub> [ft <sup>3</sup> /d]	L <sub>i</sub> [ft]	x <sub>i</sub> [ft]	y <sub>i</sub> [ft]
1	EW-01	150	28,873	25.5	0	140
2	EW-02	150	28,873	25.5	0	-140

**Aquifer:**

K = 1.0E-01 cm/sec = 283.46 ft/d  
 A = K<sub>z</sub>/K = 0.1 ← *Case 1, 1,000-ppb area*  
 n<sub>eff</sub> = 0.15  
 i = 0.001  
 phi = 0 deg = 0 rad

**Numerical:**

pathline #	x <sub>start</sub>	y <sub>start</sub>	del l
1	-500	620	0.6
2	-500	621.5	0.6
3	-500	-620	0.6
4	-500	-621.5	0.6

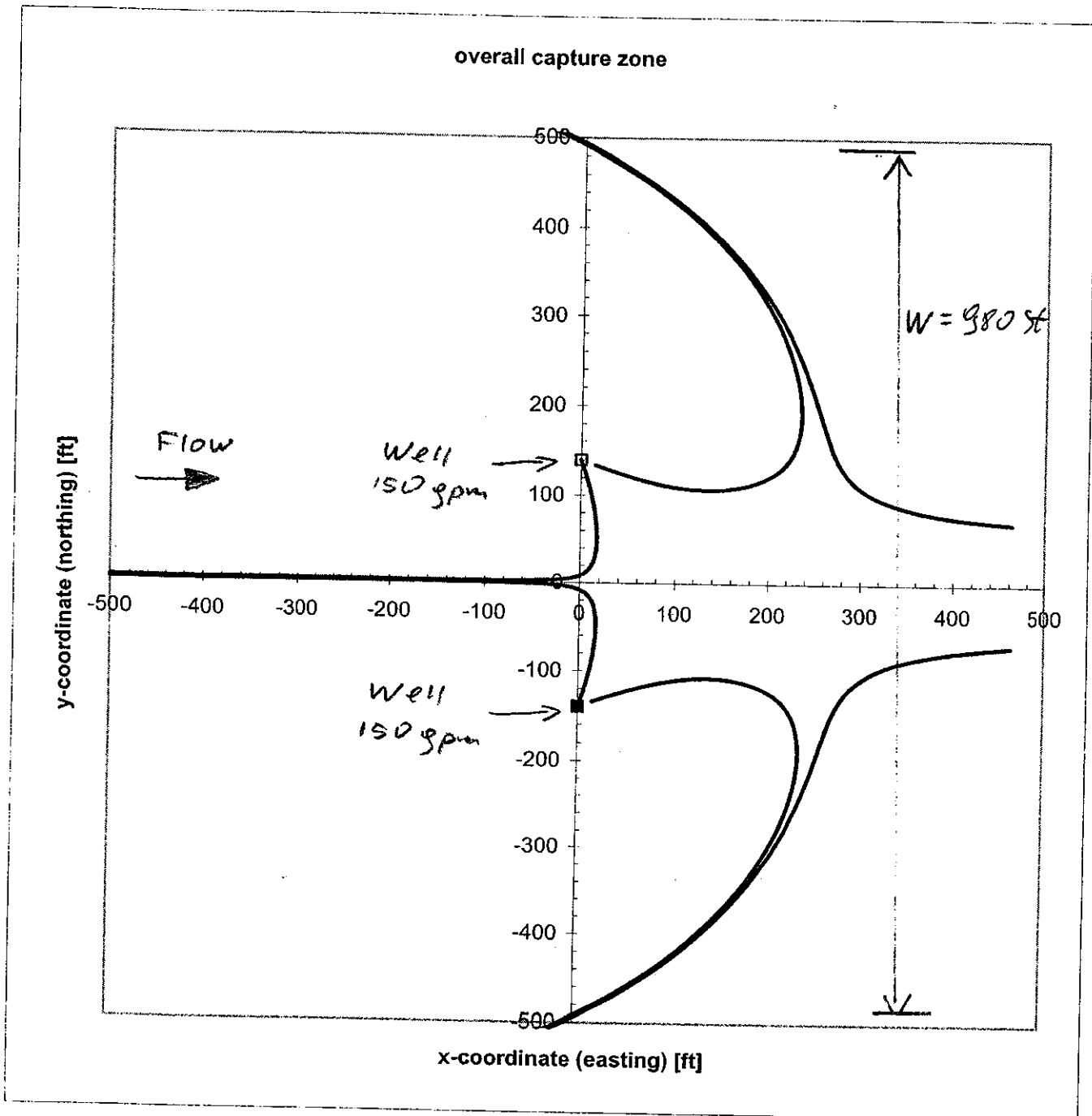

Case I, 1,000-ppb area

Required lateral extent  
of capture zone

$$W_{1,000-ppb} = 650 \text{ ft}$$



This spreadsheet calculates pathlines of particles inserted at the surface of the aquifer (z = 0) where several wells are extracting ground water. Conditions are:

- \* homogenous, anisotropic aquifer (K - horiz conductivity, K<sub>z</sub> - vertical cond)
- \* aquifer of infinite thickness (b = infinity)
- \* uniform hydraulic gradient (i - hydraulic gradient, theta - angle between positive x-axis and flow direction, measured counterclockwise)
- \* seven extraction wells (Q<sub>i</sub> - extraction rates, L<sub>i</sub> - penetration depths)
- \* wells straddle the aquifer surface (d<sub>i</sub> = 0)
- \* wells located at points (x<sub>i</sub>, y<sub>i</sub>)
- \* numerical parametrs: n<sub>eff</sub> - dummy aquifer porosity, del l - distance which a particle is allowed to move in one time step, x<sub>start</sub> & y<sub>start</sub> - initial position of a particle

Velocities calculated per "Determining Capture Zones in Homogeneous, Anisotropic Aquifers", Ground Water, July-August 1996, Vol. 34, No. 4.

$$v_x = (K i / n_{eff}) \cos(\theta) - [1 / 2 \text{PI} \text{SQRT}(A) n_{eff}] \text{EPS} \{Q_i (x - x_i) / [F(x,y)G(x,y)]\}$$

$$v_y = (K i / n_{eff}) \sin(\theta) - [1 / 2 \text{PI} \text{SQRT}(A) n_{eff}] \text{EPS} \{Q_i (y - y_i) / [F(x,y)G(x,y)]\}$$

v<sub>z</sub> = 0 (pathlines on the surface of the aquifer)

$$F(x,y) = \text{SQRT}\{(x-x_i)^2 + (y-y_i)^2 + L_i^2/A\}$$

$$G(x,y) = (x-x_i)^2 + (y-y_i)^2$$

- 1) Assume initial position (x,y)
- 2) Calculate velocities v<sub>x</sub> and v<sub>y</sub> at (x,y)
- 3) Calculate the trial position:
  - x<sub>t</sub> = x + (del l) [v<sub>x</sub> / SQRT(v<sub>x</sub><sup>2</sup> + v<sub>y</sub><sup>2</sup>)]
  - y<sub>t</sub> = y + (del l) [v<sub>y</sub> / SQRT(v<sub>x</sub><sup>2</sup> + v<sub>y</sub><sup>2</sup>)]
- 4) Calculate velocities v<sub>xt</sub> and v<sub>yt</sub> at trial position (x<sub>t</sub>, y<sub>t</sub>)
- 5) Calculate final position:
  - x<sub>f</sub> = x + (del l) [(v<sub>x</sub> + v<sub>xt</sub>) / SQRT[(v<sub>x</sub> + v<sub>xt</sub>)<sup>2</sup> + (v<sub>y</sub> + v<sub>yt</sub>)<sup>2</sup>]]
  - y<sub>f</sub> = y + (del l) [(v<sub>y</sub> + v<sub>yt</sub>) / SQRT[(v<sub>x</sub> + v<sub>xt</sub>)<sup>2</sup> + (v<sub>y</sub> + v<sub>yt</sub>)<sup>2</sup>]]

**Wells:**

Well #	Well ID	Q <sub>i</sub> [gpm]	L <sub>i</sub> [ft <sup>3</sup> /d]	x <sub>i</sub> [ft]	y <sub>i</sub> [ft]
1	EW-01	150	28,873	25.5	0
2	EW-02	150	28,873	25.5	-140

**Aquifer:**

K = 1.0E-01 cm/sec = 283.46 ft/d  
 A = K<sub>z</sub>/K = 1 ← Case 2, 1,000-ppb area  
 n<sub>eff</sub> = 0.15  
 i = 0.001  
 phi = 0 deg = 0 rad

**Numerical:**

pathline #	x <sub>start</sub>	y <sub>start</sub>	del l
1	-500	410	0.6
2	-500	415	0.6
3	-500	-410	0.6
4	-500	-415	0.6

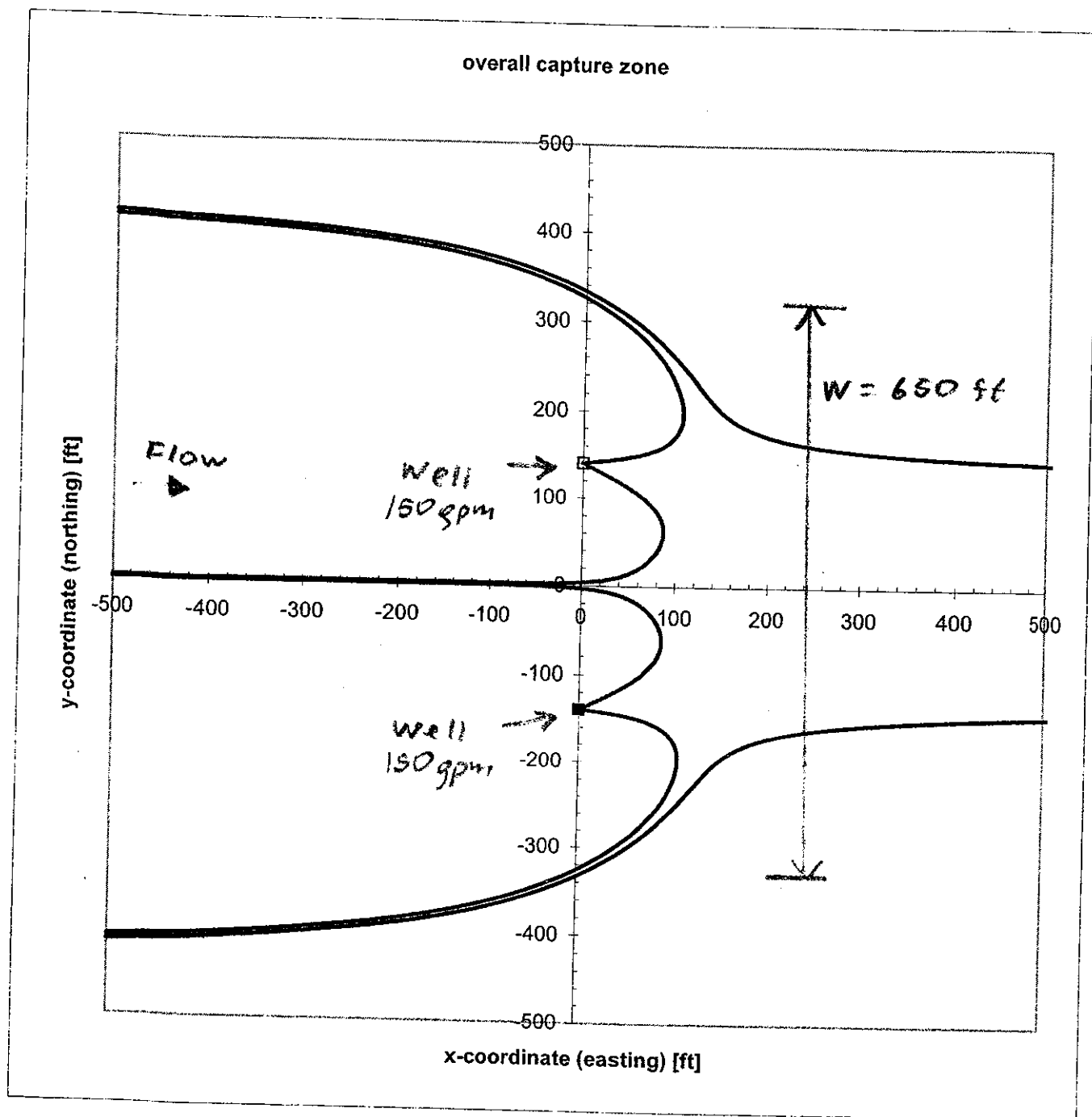

Case 2, 1,000-ppb area

Required lateral extent  
of capture zone

$$W_{1,000-ppb} = 650 \text{ ft}$$

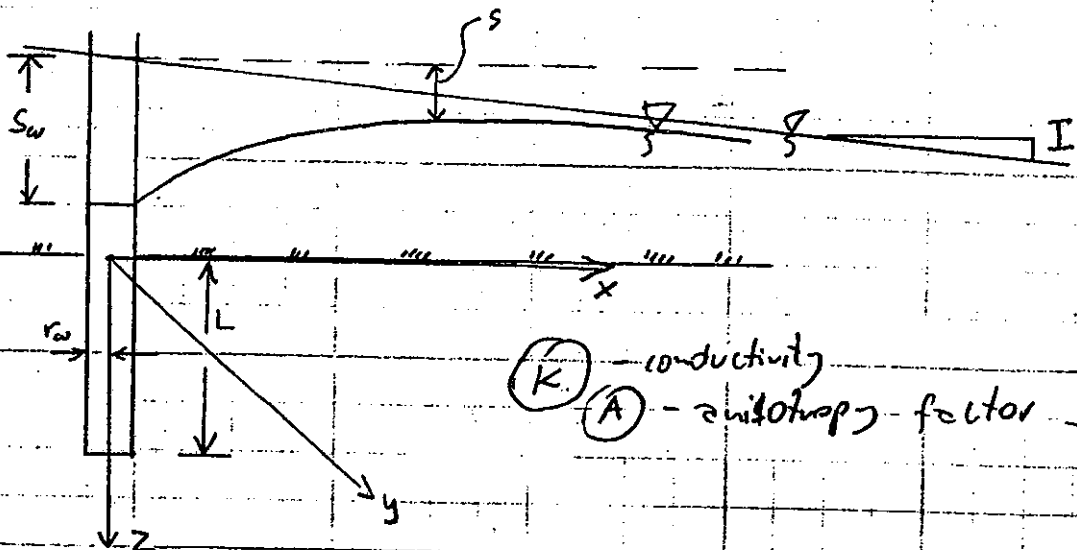

For an infinitely thick aquifer, gradient in the x direction and well starting at the top; for  $z = 0$  (equation 16 of reference 1)

$$s(x,y) = Ix + \frac{Q_w}{4\pi K L} \ln \frac{\sqrt{x^2 + y^2 + \frac{L^2}{A}} + \frac{L}{\sqrt{A}}}{\sqrt{x^2 + y^2 + \frac{L^2}{A}} - \frac{L}{\sqrt{A}}} \quad (1)$$

Eq. 16 with:

$$\frac{ds}{dx} = I + \frac{Q_w}{4\pi K L} \left[ \frac{\frac{x}{\sqrt{x^2 + y^2 + \frac{L^2}{A}} - \frac{L}{\sqrt{A}}}}{\sqrt{x^2 + y^2 + \frac{L^2}{A}} + \frac{L}{\sqrt{A}}} \right]$$

$n=0$   
 $M=1$   
 $\theta=0 \rightarrow \cos \theta = 1$   
 $\rightarrow \sin \theta = 0$   
 $d=0$   
 $x_i = y_i = 0$   
 $z=0$

$$= I + \frac{Q_w}{4\pi K L} \frac{\left( \frac{x}{\sqrt{x^2 + y^2 + \frac{L^2}{A}} - \frac{L}{\sqrt{A}}} \right)}{\left( \sqrt{x^2 + y^2 + \frac{L^2}{A}} + \frac{L}{\sqrt{A}} \right)} \times \frac{\left( \sqrt{x^2 + y^2 + \frac{L^2}{A}} - \frac{L}{\sqrt{A}} \right)}{\left( \sqrt{x^2 + y^2 + \frac{L^2}{A}} - \frac{L}{\sqrt{A}} \right)^2 \sqrt{x^2 + y^2 + \frac{L^2}{A}}}$$

Job YUSDEC KLEEMAN

Project No. 111 74 770

Sheet 2 of 4

Description

Computed by MW

Date 5/22/02

Location of Inflection Point

Checked by RBP

Date 10/4/06

Reference

$$= I + \frac{Q_w}{4\pi K \sqrt{A}} \frac{x \cdot (-2 \frac{x}{A})}{\left(\sqrt{x^2 + y^2 + \frac{L^2}{A}} + \frac{L}{\sqrt{A}}\right) \left(\sqrt{x^2 + y^2 + \frac{L^2}{A}} - \frac{L}{\sqrt{A}}\right) \sqrt{x^2 + y^2 + \frac{L^2}{A}}}$$

$$= I - \frac{Q_w}{2\pi K \sqrt{A}} \frac{x}{\left(x^2 + y^2 + \frac{L^2}{A} - \frac{L^2}{A}\right) \sqrt{x^2 + y^2 + \frac{L^2}{A}}} =$$

$$= I - \frac{Q_w}{2\pi K \sqrt{A}} \frac{x}{(x^2 + y^2) \sqrt{x^2 + y^2 + \frac{L^2}{A}}}$$

$$\frac{ds}{dx} \Big|_{y=0} = I - \frac{Q_w}{2\pi K \sqrt{A}} \frac{x}{x^2 \sqrt{x^2 + \frac{L^2}{A}}}$$

For  $x > 0$ :

$$\frac{ds}{dx} \Big|_{y=0} = I - \frac{Q_w}{2\pi K \sqrt{A}} \frac{1}{x \sqrt{x^2 + \frac{L^2}{A}}}$$

Inflection point:

$$\frac{ds}{dx} = 0 \Rightarrow I - \frac{Q_w}{2\pi K \sqrt{A}} \frac{1}{x \sqrt{x^2 + \frac{L^2}{A}}} = 0$$

$$x \sqrt{x^2 + \frac{L^2}{A}} = \frac{Q_w}{2\pi K \sqrt{A} I}$$

$$x^2 \left(x^2 + \frac{L^2}{A}\right) = \left(\frac{Q_w}{2\pi K \sqrt{A} I}\right)^2$$

Job MISSOEL KLIEMAN BROS.

Project No. 111 74 770

Sheet 3 of 4

Description

Computed by lwo

Date 5/28/02

Location of inflection point

Checked by RBP

Date 10/4/06

Reference

Substitute  $x = \sqrt{t} \Rightarrow x^2 = t$

$$t^2 + \frac{L^2}{A}t - \left(\frac{Q_w}{2\pi KVA_i}\right)^2 = 0$$

$$\Delta = \left(\frac{L^2}{A}\right)^2 + 4\left(\frac{Q_w}{2\pi KVA_i}\right)^2 = \left(\frac{L^2}{A}\right)^2 + \left(\frac{Q_w}{\pi KVA_i}\right)^2$$

$$t_1 = \frac{-\frac{L^2}{A} - \sqrt{\Delta}}{2} < 0$$

$$t_2 = \frac{-\frac{L^2}{A} + \sqrt{\Delta}}{2} > 0 \quad \text{OK}$$

$$x = \sqrt{t_2} = \sqrt{\frac{-\frac{L^2}{A} + \sqrt{\Delta}}{2}}$$

$$x_{infl} = \sqrt{\frac{-\frac{L^2}{A} + \sqrt{\left(\frac{L^2}{A}\right)^2 + \left(\frac{Q_w}{\pi KVA_i}\right)^2}}{2}}$$

Relate  $Q_w$  to well drawdown  $s_w$

- IF drawdown remains above aquifer top

$$L = \text{const} \neq f(s_w)$$

- IF drawdown is below aquifer top (unconfined aquifer)

$$L = f(s_w) = P - s_w \quad \text{P - well penetration at static conditions}$$

Job \_\_\_\_\_

Project No. 111 74 770

Sheet 4 of 4

Description Location of inflection point

Computed by wo

Date 5/28/07

Checked by RBP

Date 10/4/06

Reference

~~IF drawdown is below aquifer top (or in unconf. aquifer)~~

$$k = f(s_w) = P - s_w$$

~~$P$  - penetration of well at static conditions~~

$$Q_w = \frac{s_w 4\pi k (P - s_w)}{\ln \frac{\sqrt{r_w^2 + \frac{(P - s_w)^2}{A}} + \frac{(P - s_w)}{\sqrt{A}}}{\sqrt{r_w^2 + \frac{(P - s_w)^2}{A}} - \frac{(P - s_w)}{\sqrt{A}}}}$$

From (1) on sheet 1, and for well face

$$x^2 + y^2 = r_w^2$$

i.e.  $x$  - small  $\Rightarrow$   $x$  is negligible  
 $s = s_w$

$$s_w = \frac{Q_w}{4\pi k L} \ln \frac{\sqrt{r_w^2 + \frac{L^2}{A}} + \frac{L}{\sqrt{A}}}{\sqrt{r_w^2 + \frac{L^2}{A}} - \frac{L}{\sqrt{A}}}$$

$$Q_w = \frac{s_w 4\pi k L}{\ln \frac{\sqrt{r_w^2 + \frac{L^2}{A}} + \frac{L}{\sqrt{A}}}{\sqrt{r_w^2 + \frac{L^2}{A}} - \frac{L}{\sqrt{A}}}}$$

Reference 1, equation 17a. Substitute:

- $h = 0$  - aquifer of infinite thickness
- $d_i = 0$  - wells straddling the water table
- $z = 0$  - pathlines on aquifer surface

$$v_x = \frac{KI \cos \theta}{\eta} + \sum_{i=1}^M \frac{Q_i (x-x_i)}{4\pi L_i \eta}$$

$$\left\{ \frac{1}{\sqrt{(x-x_i)^2 + (y-y_i)^2 + \frac{L_i^2}{A}} \left( \sqrt{(x-x_i)^2 + (y-y_i)^2 + \frac{L_i^2}{A}} + \frac{L_i}{\sqrt{A}} \right)} \right.$$

$$\left. - \frac{1}{\sqrt{(x-x_i)^2 + (y-y_i)^2} \sqrt{(x-x_i)^2 + (y-y_i)^2}} \right\} \quad \textcircled{1}$$

$$+ \frac{1}{\sqrt{(x-x_i)^2 + (y-y_i)^2} \sqrt{(x-x_i)^2 + (y-y_i)^2}} \quad \textcircled{2}$$

$$\left. \frac{1}{\sqrt{(x-x_i)^2 + (y-y_i)^2 + \frac{L_i^2}{A}} \left( \sqrt{(x-x_i)^2 + (y-y_i)^2 + \frac{L_i^2}{A}} - \frac{L_i}{\sqrt{A}} \right)} \right\}$$

① and ② cancel out,  $\frac{1}{\sqrt{(x-x_i)^2 + (y-y_i)^2 + \frac{L_i^2}{A}}}$  can be factored out.

$$V_x = \frac{KI}{\eta} \cos \theta + \sum_{i=1}^M \frac{Q_i (x-x_i)}{4\pi L_i \eta} \cdot \frac{1}{\sqrt{(x-x_i)^2 + (y-y_i)^2 + \frac{L_i^2}{A}}}$$

$$\left\{ \frac{1}{\sqrt{(x-x_i)^2 + (y-y_i)^2 + \frac{L_i^2}{A}} + \frac{L_i}{\sqrt{A}}} - \frac{1}{\sqrt{(x-x_i)^2 + (y-y_i)^2 + \frac{L_i^2}{A}} - \frac{L_i}{\sqrt{A}}} \right\}$$

Term in the brackets can be expanded using the common denominator

$$\left\{ \right\} = \frac{\sqrt{(x-x_i)^2 + (y-y_i)^2 + \frac{L_i^2}{A}} - \frac{L_i}{\sqrt{A}} - \left( \sqrt{(x-x_i)^2 + (y-y_i)^2 + \frac{L_i^2}{A}} + \frac{L_i}{\sqrt{A}} \right)}{(x-x_i)^2 + (y-y_i)^2 + \frac{L_i^2}{A} - \frac{L_i^2}{A}}$$

$$= \frac{\sqrt{(x-x_i)^2 + (y-y_i)^2 + \frac{L_i^2}{A}} - \frac{L_i}{\sqrt{A}} - \sqrt{(x-x_i)^2 + (y-y_i)^2 + \frac{L_i^2}{A}} - \frac{L_i}{\sqrt{A}}}{(x-x_i)^2 + (y-y_i)^2}$$

$$= \frac{-2 \frac{L_i}{\sqrt{A}}}{(x-x_i)^2 + (y-y_i)^2}$$

From this

$$V_x = \frac{KI}{\eta} \cos \theta + \sum_{i=1}^M \frac{Q_i (x-x_i)}{2\pi L_i \eta} \cdot \frac{1}{\sqrt{(x-x_i)^2 + (y-y_i)^2 + \frac{L_i^2}{A}}} - \frac{2 \frac{L_i}{\sqrt{A}}}{(x-x_i)^2 + (y-y_i)^2}$$

$$V_x = \frac{KI}{\eta} \cos \theta - \sum \frac{Q_i (x-x_i)}{2\pi \eta \sqrt{A}} \cdot \frac{1}{\sqrt{(x-x_i)^2 + (y-y_i)^2 + \frac{L_i^2}{A}} [(x-x_i)^2 + (y-y_i)^2]}$$



$$V_x = \frac{KI}{\eta} \cos \theta - \frac{1}{2\pi VA \eta} \sum_{i=1}^M \frac{Q_i (x - x_i)}{\sqrt{(x - x_i)^2 + (y - y_i)^2 + \frac{L_i^2}{A}} \left[ (x - x_i)^2 + (y - y_i)^2 \right]}$$

Analogically, from equation 17b

$$V_y = \frac{KI}{\eta} \sin \theta - \frac{1}{2\pi VA \eta} \sum_{i=1}^M \frac{Q_i (y - y_i)}{\sqrt{(x - x_i)^2 + (y - y_i)^2 + \frac{L_i^2}{A}} \left[ (x - x_i)^2 + (y - y_i)^2 \right]}$$

Substituting  $h=0$ ,  $d_i=0$  and  $z=0$  to equation 17c

$$V_z = \sum_{i=1}^M \frac{Q_i VA}{4\pi L_i \eta} \left\{ \frac{1}{\sqrt{(x - x_i)^2 + (y - y_i)^2 + \frac{L_i^2}{A}}} - \frac{1}{\sqrt{(x - x_i)^2 + (y - y_i)^2}} \right\}$$

$$- \frac{1}{\sqrt{(x - x_i)^2 + (y - y_i)^2 + \frac{L_i^2}{A}}} + \frac{1}{\sqrt{(x - x_i)^2 + (y - y_i)^2}}$$

$$\left. \frac{1}{\sqrt{(x - x_i)^2 + (y - y_i)^2 + \frac{L_i^2}{A}}} \right\}$$

$$V_z = \sum_{i=1}^M \frac{Q_i VA}{4\pi L_i \eta} \cdot 0$$

$$V_z = 0$$

# Verification of Spreadsheet

Capture zone plotted using spreadsheet table

One well, located at (0,0), pumping 92.68 gpm

$K = 8 \times 10^{-2} \text{ cm/s} = 226.77 \text{ ft/d}$   
 $A = K_2/K = 0.01$   
 $I = 0.0010$   
 $Q = 92.68 \text{ gpm} = 17,839.75 \frac{\text{ft}^3}{\text{d}}$   
 $L = 14.86 \text{ ft}$

Arbitrary set of parameters used for verification

Calculated stagnation point

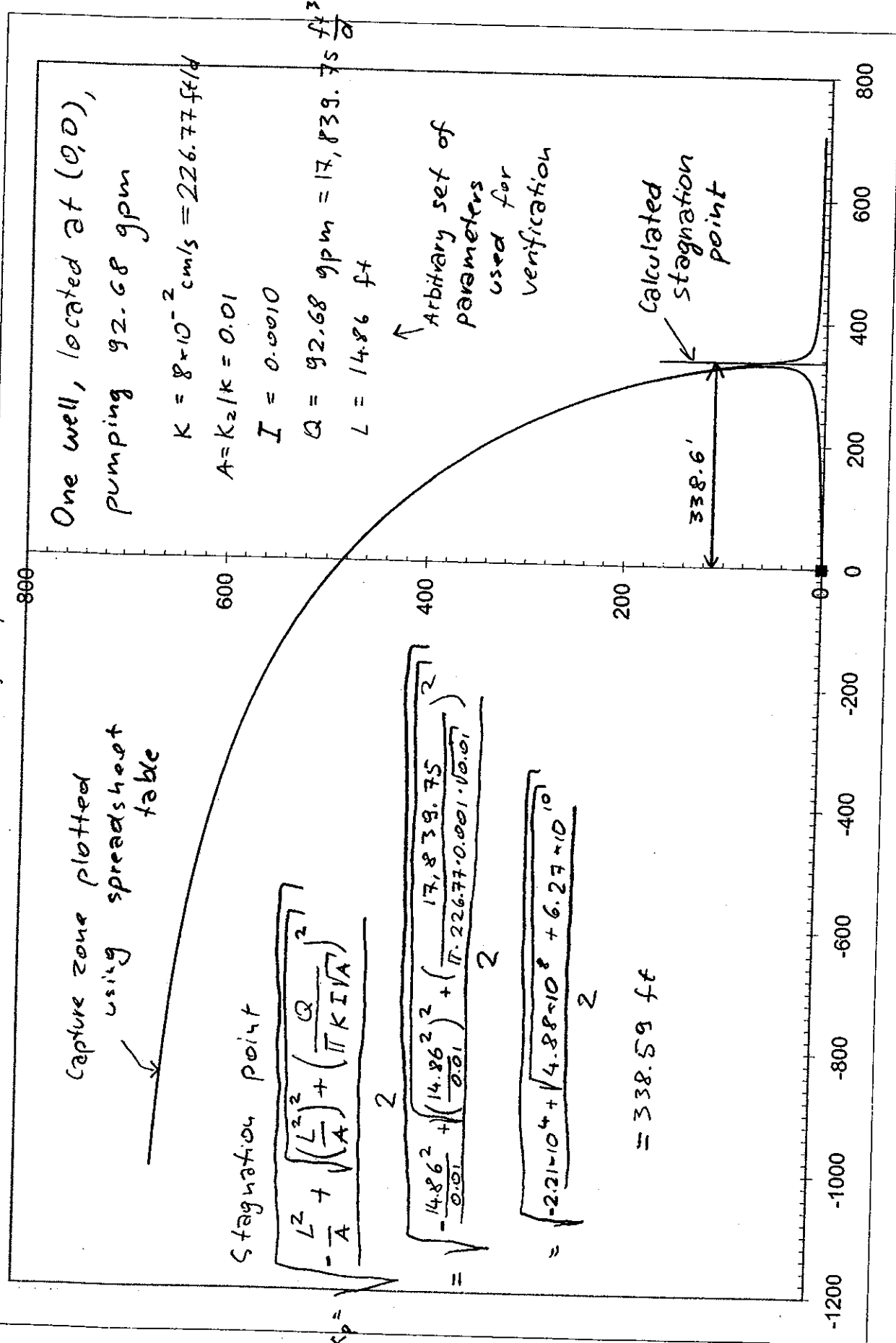

Stagnation point

$$-\frac{L^2}{A} + \sqrt{\left(\frac{L^2}{A}\right)^2 + \left(\frac{Q}{\pi K I \sqrt{A}}\right)^2}$$

$$= \sqrt{\frac{-14.86^2}{0.01} + \left(\frac{17,839.75}{\pi \cdot 226.77 \cdot 0.001 \cdot \sqrt{0.01}}\right)^2}$$

$$= \sqrt{-2.21 \times 10^4 + \sqrt{4.88 \times 10^8 + 6.27 \times 10^{10}}}$$

$$= 338.59 \text{ ft}$$

# Verification of Spreadsheet

• Half-width

$$r = \sqrt{\frac{Q}{\pi K I}} = \sqrt{\frac{17,839.75}{\pi \cdot 226.77 \cdot 0.0010}} = 158.24 \text{ ft}$$

Capture zone plotted using spreadsheet table

Zero-penetration well at (0,0), pumping 92.68 gpm

$$K = 8 \times 10^{-2} \text{ cm/s} = 226.77 \text{ ft/d}$$

$$A = Kz/K = 1$$

$$I = 0.0010$$

$$Q = 92.68 \text{ gpm} = 17,839.75 \frac{\text{ft}^3}{\text{d}}$$

$$L = 1 \text{ ft}$$

• Stagnation point

$$x_p = \sqrt{\frac{-\frac{L^2}{A} + \sqrt{\left(\frac{L^2}{A}\right)^2 + \left(\frac{Q}{\pi K I A}\right)^2}}{2}}$$

$$x_p = \sqrt{\frac{-\frac{1^2}{1} + \sqrt{\left(\frac{1^2}{1}\right)^2 + \left(\frac{17,839.75}{\pi \cdot 226.77 \cdot 0.001 \cdot \pi}\right)^2}}{2}}$$

$$= \sqrt{\frac{-1 + \sqrt{1 + 6.27 \times 10^8}}{2}} = 111.89 \text{ ft}$$

Calculated half-width of capture zone

158.2'

111.9'

Calculated Stagnation point

Arbitrary set of parameters used for verification

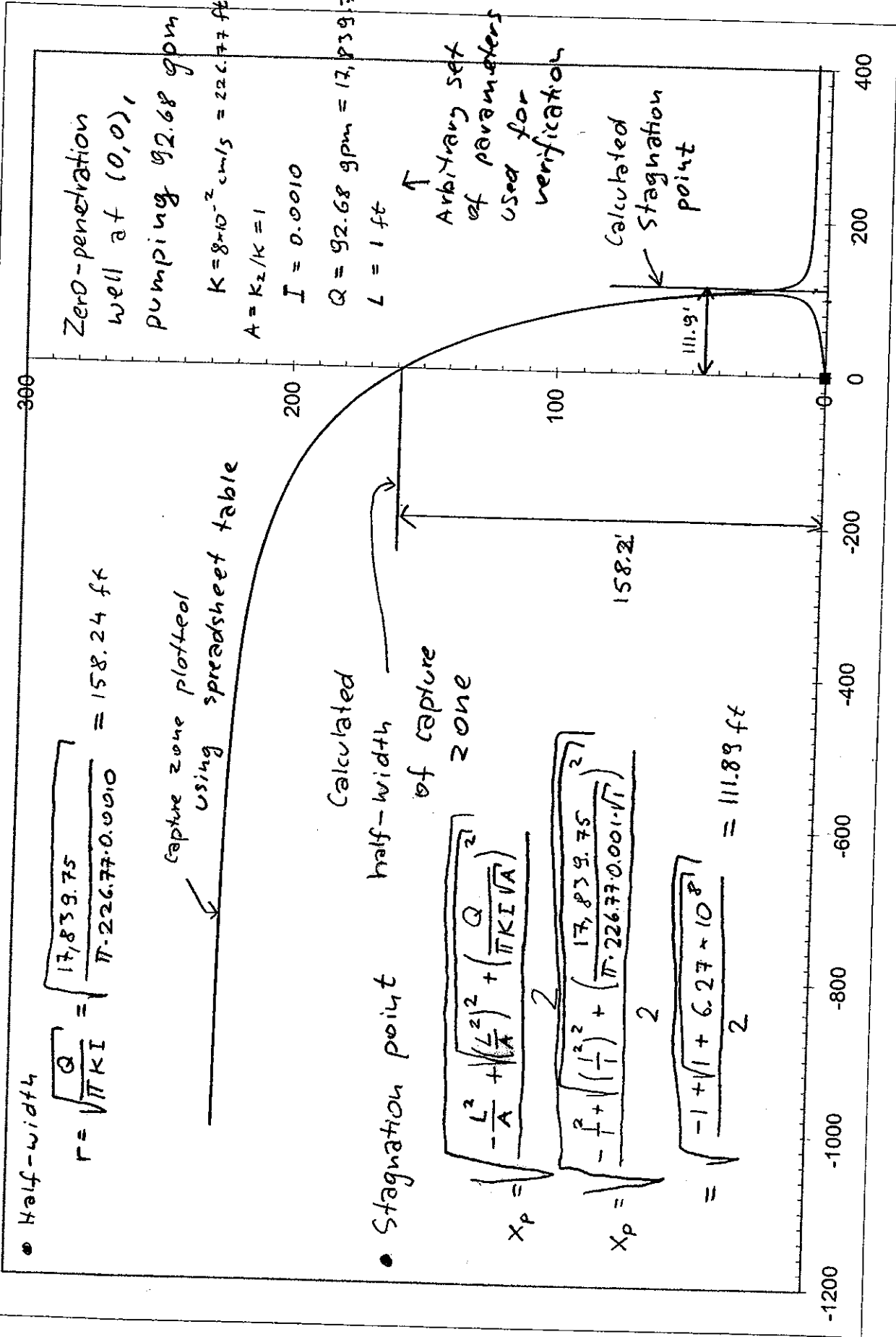

# Verification of Spreadsheet

capture zone plotted using spreadsheet table

Note: The effect of seven wells located at origin and pumping total of 92.68 gpm is the same as the effect of a single well located at origin and pumping 92.68 gpm. Capture zones here and on page 23 should be the same. They are.

Seven wells, all located at (0,0), pumping total of 92.68 gpm

$$k = 8 \times 10^{-2} \text{ cm/s}$$

$$A = k_2/k = 0.01$$

$$I = 0.0010$$

$$Q = 92.68 \text{ gpm (total)}$$

$$L = 14.86 \text{ ft (each well)}$$

↑  
Arbitrary set of parameters used for verification

Calculated stagnation point

338.6'

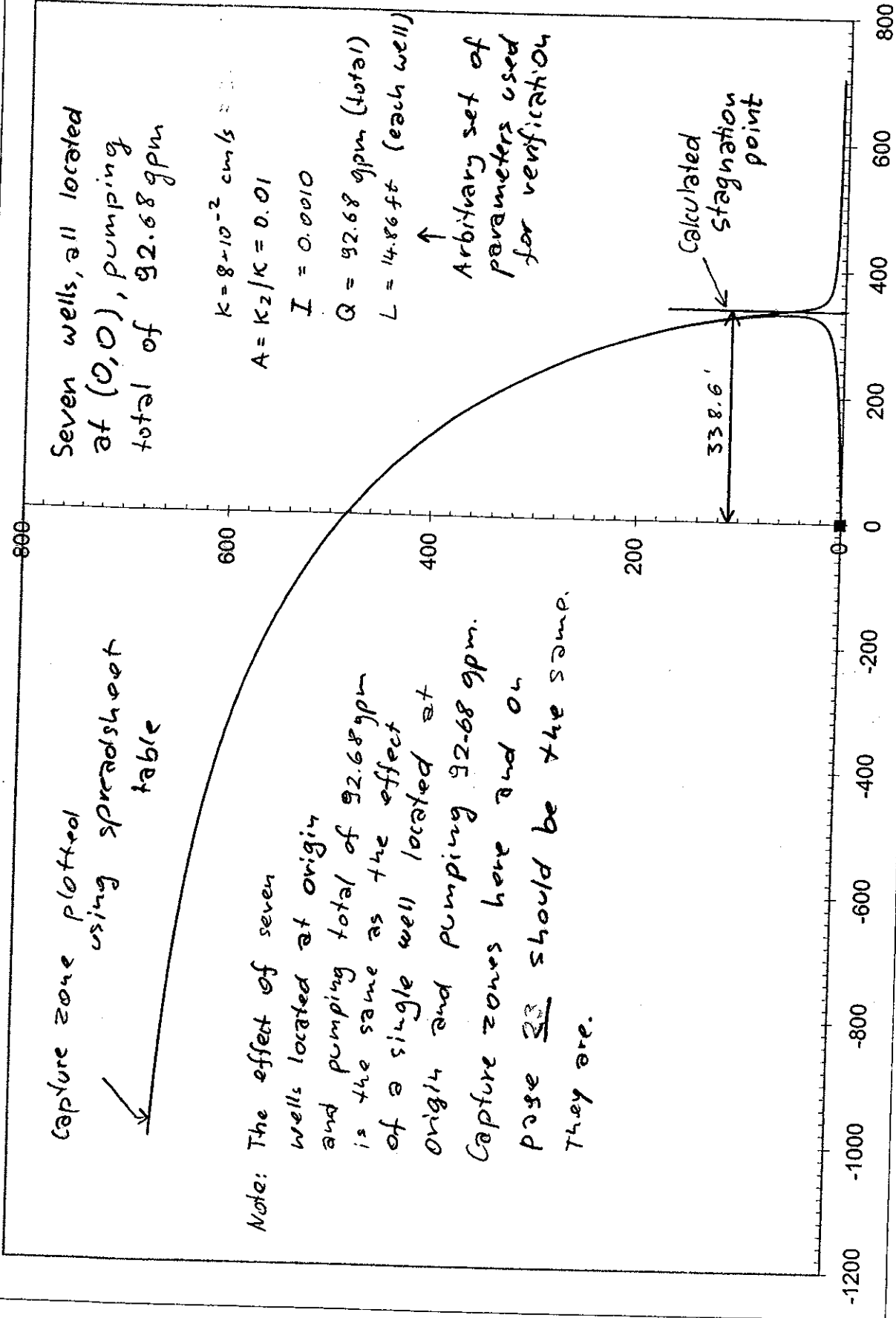

# Anisotropic Aquifers

by David C. Schafer<sup>a</sup>

pg 26

of 35

## Abstract

A method is presented for determining steady-state capture zones in three dimensions around horizontal drains and vertical wells in homogeneous, anisotropic aquifers in a uniform flow field. Equations are presented for determining drawdown and velocity vector components in three dimensions around drains and wells. Using these equations, a second-order Runge-Kutta particle tracking algorithm is applied to trace streamlines in three dimensions. By tracking a large number of particles, it is possible to determine areas where capture occurs and areas where particles escape capture. The resulting 3D capture zones are diagrammed as both 2D (section view) plots and 3D plots.

## Introduction

In designing remediation systems for contamination plumes, hydraulic analysis is required to determine appropriate flow rates and locations of extraction wells or trenches to achieve hydraulic containment of the contaminants. Determining capture zones in two dimensions is well understood and relatively straightforward (Javandel and Tsang, 1986). Simple, analytical equations can be used, for instance, to calculate discharge rates necessary to achieve hydraulic containment. Alternatively, several easy-to-use, analytical flow models are readily available to calculate and diagram capture zones for proposed recovery systems.

A limitation of 2D solutions, however, is the assumption that the capture zone fully penetrates the aquifer. Although this assumption might be valid for relatively thin aquifers, it could be inappropriate for thick aquifers in which the contaminant plume penetrates just a fraction of the aquifer thickness. In such systems, treating the problem as two-dimensional leads to unnecessarily high extraction rates, as well as expensive remediation system treatment and operating costs.

When a thick aquifer becomes contaminated, dissolved contaminants often exist only in the upper portions of the aquifer. Under these circumstances, the most economical hydraulic containment system is often one that captures only the shallow (contaminated) ground water, allowing deeper, clean water to pass beneath the extraction system. For these installations, existing 2D equations and flow models are not adequate for accurately describing capture zones and required flow rates and a 3D approach is required.

## Methods

3D capture zone analysis is accomplished by tracing streamlines in three dimensions. Streamlines are traced from a large number of different starting points and a determination is made for each starting point as to whether or not the streamline reaches the extraction system or passes on downgradient. By tracking a sufficient number of particles, it is possible to deter-

mine those areas where capture is occurring and those areas where particles are escaping capture.

Before particle tracking can be accomplished, it is first necessary to determine hydraulic head (or drawdown) in three dimensions around the extraction system. After the drawdown in three dimensions is known, it is possible to determine the extraction-induced gradients in three dimensions by differentiating the drawdown with respect to  $x$ ,  $y$ , and  $z$ . Finally, velocities in the  $x$ ,  $y$ , and  $z$  directions can be computed from these gradients. After this three-dimensional velocity field has been determined, a standard numerical integration technique is used to calculate the paths that particles would take moving through that field. If a particle path leads to the extraction system, the particle is assumed to have been captured, whereas a particle that bypasses the extraction system by a sufficient distance is assumed to have escaped.

In performing the analysis, it is most convenient to examine the capture zone "one slice at a time." The typical procedure is to fix a specific  $x$  coordinate and determine in section view the profile of the capture zone in a plane passing through that  $x$  coordinate and oriented perpendicular to the  $x$  axis. By repeating this process for a number of  $x$  coordinates, it is possible to gain an understanding of what the capture zone looks like in three dimensions.

At each  $x$  location, the calculated capture zone profile can be compared with the known position of the contaminant plume to judge whether complete plume capture will occur.

## Theory

### Drawdown Around a Point Sink

Drawdown around a line sink feature such as a horizontal drain or vertical well can be determined by representing the feature as an infinite number of point sinks, each with an infinitesimal discharge such that their combined discharge equals that of the drain or well. The drawdown for each point sink is determined and the cumulative drawdown is obtained by integrating along the length of the line sink. The first step is to determine the steady-state drawdown around a point sink in a homogeneous, anisotropic, infinitely thick aquifer. In this analysis, anisotropy is considered in the vertical direction because the horizontal deposition of most sediments tends to produce greater hydraulic conductivity in the horizontal direction (paral-

<sup>a</sup> Geraghty & Miller, Inc., 105 Fifth Avenue South, Suite 350, Minneapolis, Minnesota 55401.

Received December 1994, revised June 1995, accepted June 1995.

l to the bedding planes) and lower hydraulic conductivity in the vertical direction (perpendicular to the bedding planes).

Consider an anisotropic aquifer having horizontal hydraulic conductivity,  $K$ , and vertical hydraulic conductivity,  $K_z$ , with the anisotropy ratio,  $A$ , defined as  $K_z/K$ . According to Harr (1962) and Strack (1989), the anisotropic system can be transformed to an equivalent isotropic one by stretching the vertical  $z$  axis by the square root of the anisotropy ratio and assigning an isotropic hydraulic conductivity equal to  $K(A)^{1/2}$ . Thus, in the transformed system, indicated by the asterisk,

$$z^* = \frac{z}{(A)^{1/2}} \quad (1a)$$

$$K^* = K(A)^{1/2} \quad (1b)$$

In the isotropic aquifer, the point sink drawdown equation for steady-state conditions can be obtained from Darcy's law. Assuming an infinitely thick aquifer, flow toward point  $(x_p, y_p, z_p^*)$  through a spherical shell of radius  $r_D$  and thickness  $-dr$  ( $dr$  is taken to be negative, i.e.,  $r_D$  is decreasing from infinity to zero) is, according to Darcy's law

$$Q = K^* \left( \frac{-ds}{dr_D} \right) 4\pi r_D^2 \quad (2)$$

In this equation,  $Q$  is flow rate, and  $s$  represents drawdown. Rearranging terms gives

$$-ds = \frac{Q}{4\pi K^*} \frac{dr_D}{r_D^2} \quad (3)$$

Integrating from infinity to  $r$  yields

$$-[s(r) - s(\infty)] = \frac{Q}{4\pi K^*} \left[ -\left( \frac{1}{r} - \frac{1}{\infty} \right) \right] \quad (4)$$

and, because the drawdown at infinity is zero,

$$s = \frac{Q}{4\pi K^* r} \quad (5)$$

At a point  $(x, y, z^*)$  located a distance  $r$  from  $(x_p, y_p, z_p^*)$ , we have

$$s = \frac{Q}{4\pi K^*} \frac{1}{[(x - x_p)^2 + (y - y_p)^2 + (z^* - z_p^*)^2]^{1/2}} \quad (6)$$

Finally, in terms of the anisotropic aquifer,

$$s = \frac{Q}{4\pi K(A)^{1/2}} \frac{1}{[(x - x_p)^2 + (y - y_p)^2 + ((z - z_p)/A)]^{1/2}} \quad \dots (7)$$

### Horizontal Drain

Ground-water extraction is frequently accomplished by pumping from shallow, horizontal trenches or drains constructed across the front of contaminant plumes. In addition horizontal wells are becoming popular for capturing contaminants because they can be used effectively to "skim" broad shallow plumes at the tops of thick aquifers. Special equations are required to calculate capture zones around these horizontal pumping features.

Figure 1 shows a horizontal drain of length  $L$  located at a depth  $d$  below the top of an aquifer of thickness  $b$ , centered at  $x = y = 0$  and oriented parallel to the  $y$  axis. Because the aquifer is bounded at the top and bottom, the theory of images is used to transform it to an infinitely thick aquifer. Figure 2 shows images obtained by repeatedly reflecting the actual drain and subsequent image drains across the upper and lower aquifer boundaries. The resulting pattern of image drains is symmetric about both the upper and lower boundaries, thus assuring a no-flow condition at each boundary.

The drawdown around a drain is calculated by integrating the point sink equation. For a drain such as that shown in Figure 1 but at an arbitrary elevation,  $Z$ , the infinitesimal flow to a segment of length  $dy_D$  at position  $y_D$  is

$$dq = (Q/L) dy_D \quad (8)$$

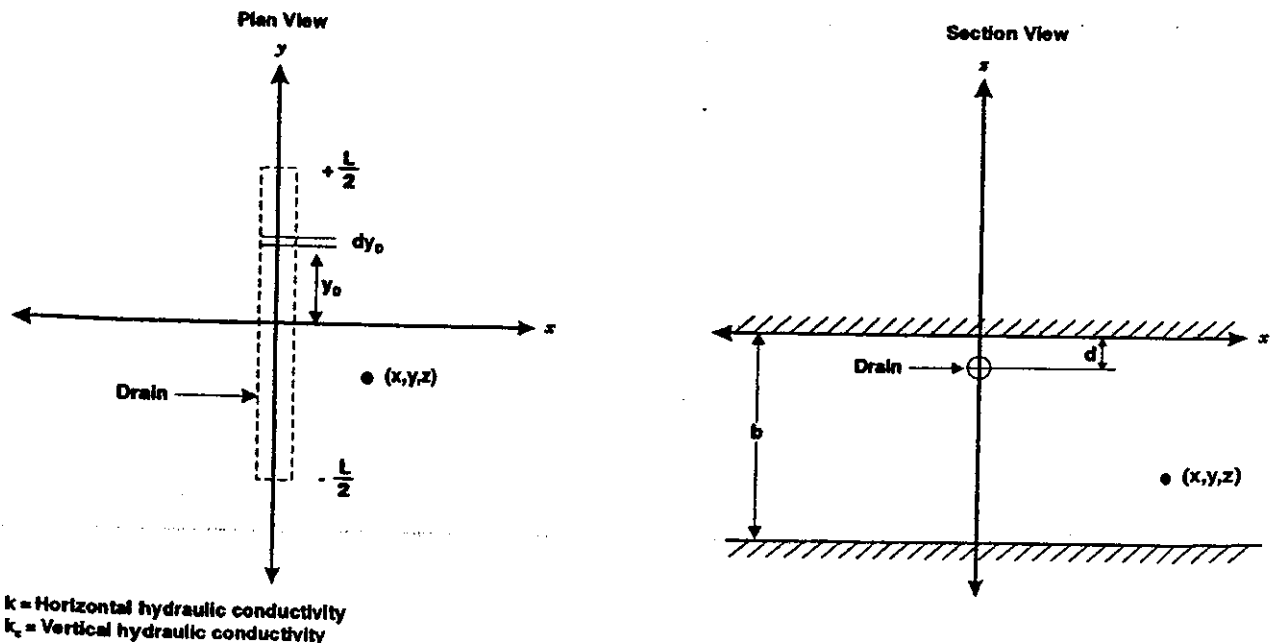

$k$  = Horizontal hydraulic conductivity  
 $k_z$  = Vertical hydraulic conductivity

Fig. 1. Plan and section views of horizontal drain.

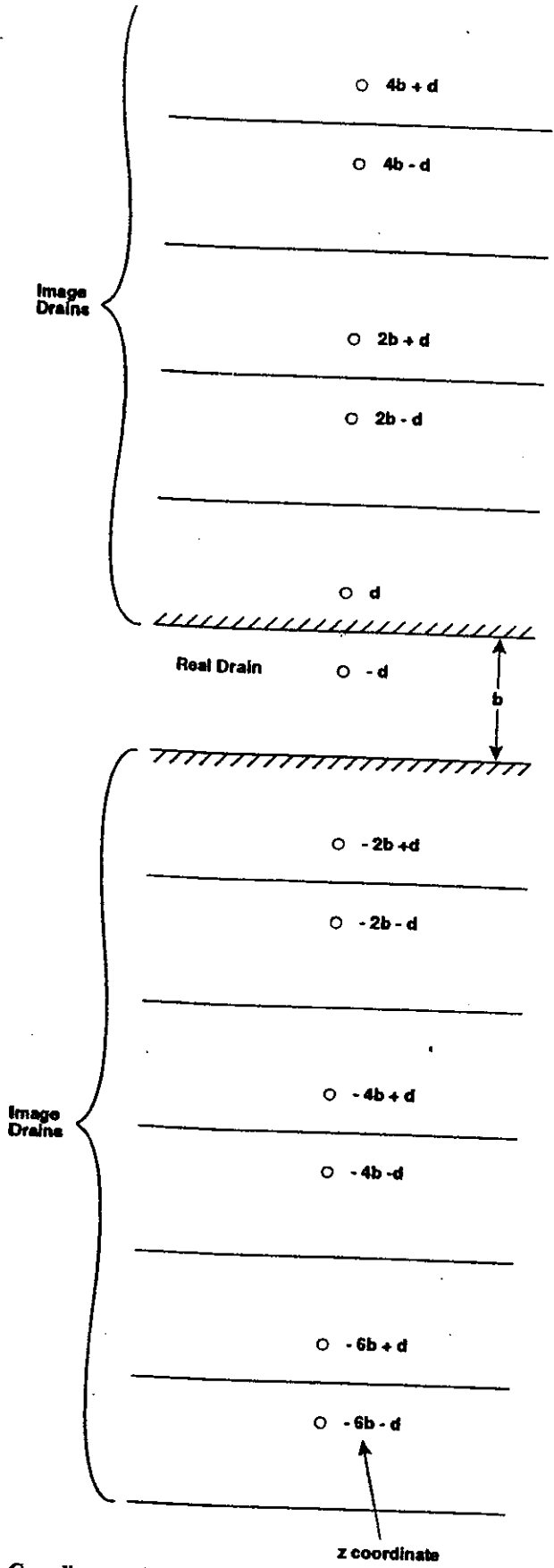

Fig. 2. Coordinates of real drain and image drains.

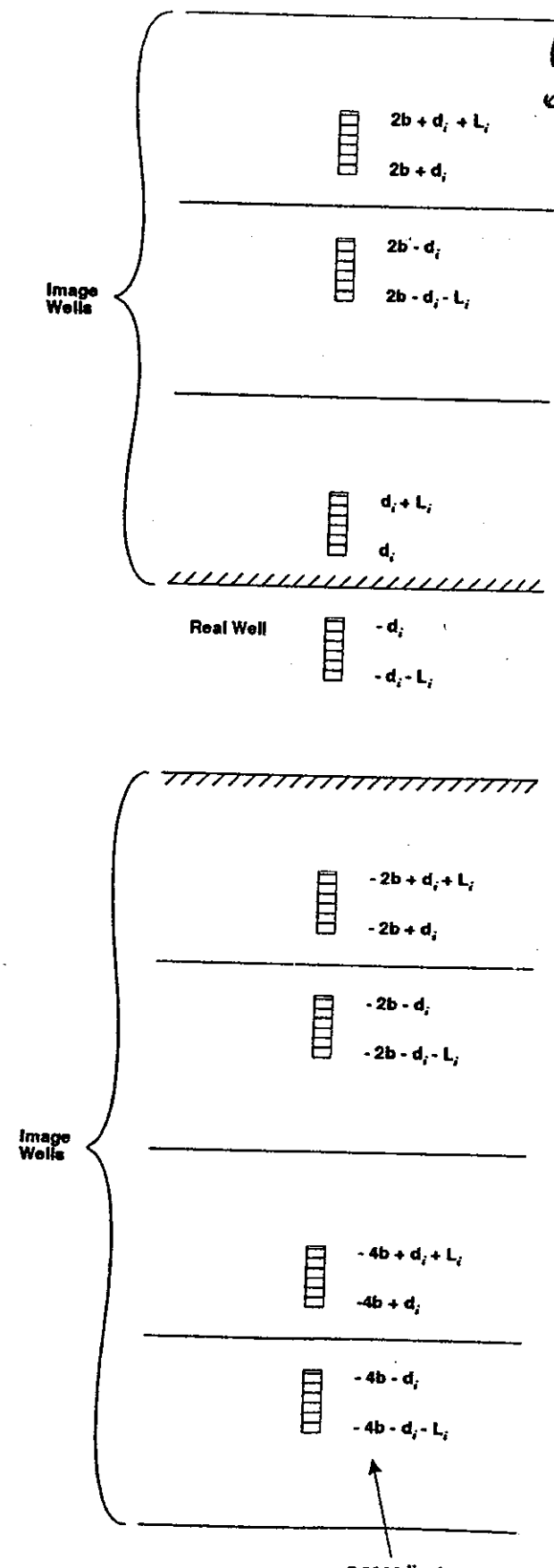
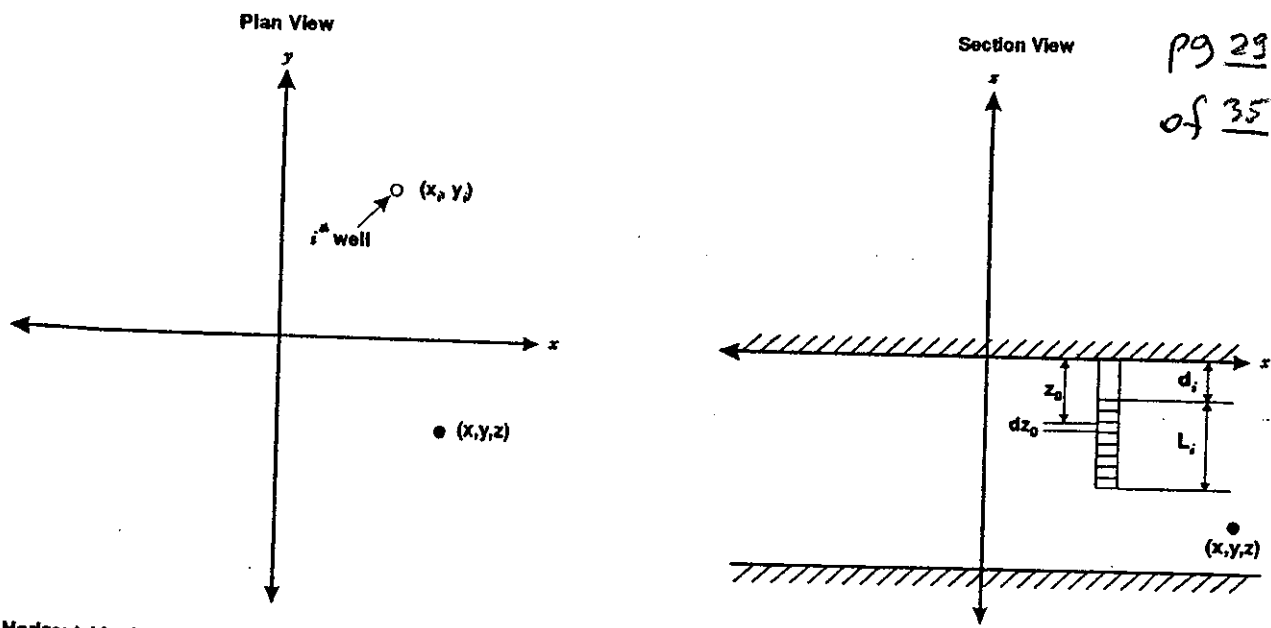

Fig. 4. Intake coordinates of real well and image wells.

**Vertical Wells**

The equation for drawdown around a system of partially penetrating extraction wells can be derived in the same manner as the one for the horizontal drain. Analysis of flow to vertical, partially penetrating wells has been treated by others for both water flow (Philip and Walter, 1992) and air flow in the vadose zone (Shan, Falta, and Javandel, 1992).



$k$  = Horizontal hydraulic conductivity  
 $k_v$  = Vertical hydraulic conductivity

Fig. 3. Plan and section views of partially penetrating well.

Figure 3 shows the intake for the  $i^{\text{th}}$  extraction well (of a multiple well system), located at  $(x_i, y_i)$ , pumped at rate  $Q_i$ , and open to the aquifer between  $d_i$  and  $d_i + L_i$  below the top of the aquifer. Using the point sink equation, the infinitesimal drawdown at point  $(x, y, z)$  caused by flow to a well segment of length  $dz_D$  at position  $z_D$  is

$$ds = \frac{(Q_i/L_i)}{4\pi K(A)^{1/2}} \frac{dz_D}{[(x-x_i)^2 + (y-y_i)^2 + ((z-z_D)^2/A)]^{1/2}} \quad (14)$$

For a well open to the aquifer between the arbitrary depths of  $Z_1$  (bottom) and  $Z_2$  (top), the total drawdown is obtained by integrating equation (14) from  $Z_1$  to  $Z_2$  as follows:

$$s = \frac{Q_i}{4\pi K L_i (A)^{1/2}} \int_{Z_1}^{Z_2} \frac{dz}{[(x-x_i)^2 + (y-y_i)^2 + \frac{(z-z_D)^2}{A}]^{1/2}}$$

$$= \frac{Q_i}{4\pi K L_i} \ln \frac{[(x-x_i)^2 + (y-y_i)^2 + \frac{(z-Z_1)^2}{A}]^{1/2} + \frac{z-Z_1}{(A)^{1/2}}}{[(x-x_i)^2 + (y-y_i)^2 + \frac{(z-Z_2)^2}{A}]^{1/2} + \frac{z-Z_2}{(A)^{1/2}}} \quad (15)$$

Figure 4 shows image wells incorporated to simulate the upper and lower aquifer boundaries, along with the  $z$  coordinates of the tops and bottoms of the intake sections for each well. These coordinates are substituted into equation (15) for each image. For a system of  $M$  extraction wells, the principle of superposition is applied by adding together drawdown components for all wells in the extraction system and all of their images. Finally, the hydraulic gradient term is incorporated, yielding

$$s = I_x \cos\theta + I_y \sin\theta + \sum_{i=1}^M \frac{Q_i}{4\pi K L_i} \sum_{n=-\infty}^{\infty} \left[ \ln \frac{[(x-x_i)^2 + (y-y_i)^2 + \frac{(z-2nb+d_i+L_i)^2}{A}]^{1/2} + \frac{z-2nb+d_i+L_i}{(A)^{1/2}}}{[(x-x_i)^2 + (y-y_i)^2 + \frac{(z-2nb+d_i)^2}{A}]^{1/2} + \frac{z-2nb+d_i}{(A)^{1/2}}} \right.$$

$$\left. + \ln \frac{[(x-x_i)^2 + (y-y_i)^2 + \frac{(z-2nb-d_i)^2}{A}]^{1/2} + \frac{z-2nb-d_i}{(A)^{1/2}}}{[(x-x_i)^2 + (y-y_i)^2 + \frac{(z-2nb-d_i-L_i)^2}{A}]^{1/2} + \frac{z-2nb-d_i-L_i}{(A)^{1/2}}} \right] \quad (16)$$



Summarizing the terms in this equation:  $s$  = distance of the water level at  $(x, y, z)$  below the static water level measured at the origin of the coordinate system;  $I$  = magnitude of the regional gradient;  $\theta$  = gradient direction, measured from the positive  $x$  axis;  $Q_i$  = flow rate of the  $i$ th well;  $K$  = horizontal hydraulic conductivity;  $A = K_z/K$  ( $K_z$  = vertical hydraulic conductivity);  $x, y, z$  = coordinates of point where  $s$  is computed;  $b$  = aquifer thickness;  $M$  = number of wells;  $x_i, y_i$  = coordinates of  $i$ th well;  $d_i$  = distance from top of aquifer to top of intake in  $i$ th well; and  $L_i$  = length of intake in  $i$ th well.

The terms corresponding to  $n = 0$  represent the real extraction well and one image reflected across the top of the aquifer. Terms corresponding to negative values of  $n$  represent image pairs below the aquifer, whereas terms corresponding to positive values of  $n$  represent image pairs above the aquifer.

As before, particle velocity vector components are computed by differentiating  $s$  with respect to  $x, y,$  and  $z$  and substituting into equations (12a), (12b), and (12c), yielding the following:

$$v_x = \frac{KI}{\eta} \cos\theta + \sum_{i=1}^M \frac{Q_i(x-x_i)}{4\pi L_i \eta} \cdot \sum_{n=-\infty}^{\infty} \left[ \frac{1}{\left[ (x-x_i)^2 + (y-y_i)^2 + \frac{(z-2nb+d_i+L_i)^2}{A} \right]^{1/2} \left( \left[ (x-x_i)^2 + (y-y_i)^2 + \frac{(z-2nb+d_i+L_i)^2}{A} \right]^{1/2} + \frac{z-2nb+d_i+L_i}{(A)^{1/2}} \right)} - \frac{1}{\left[ (x-x_i)^2 + (y-y_i)^2 + \frac{(z-2nb+d_i)^2}{A} \right]^{1/2} \left( \left[ (x-x_i)^2 + (y-y_i)^2 + \frac{(z-2nb+d_i)^2}{A} \right]^{1/2} + \frac{z-2nb+d_i}{(A)^{1/2}} \right)} + \frac{1}{\left[ (x-x_i)^2 + (y-y_i)^2 + \frac{(z-2nb-d_i)^2}{A} \right]^{1/2} \left( \left[ (x-x_i)^2 + (y-y_i)^2 + \frac{(z-2nb-d_i)^2}{A} \right]^{1/2} + \frac{z-2nb-d_i}{(A)^{1/2}} \right)} - \frac{1}{\left[ (x-x_i)^2 + (y-y_i)^2 + \frac{(z-2nb-d_i-L_i)^2}{A} \right]^{1/2} \left( \left[ (x-x_i)^2 + (y-y_i)^2 + \frac{(z-2nb-d_i-L_i)^2}{A} \right]^{1/2} + \frac{z-2nb-d_i-L_i}{(A)^{1/2}} \right)} \right] \dots (17a)$$

$$v_y = \frac{KI}{\eta} \sin\theta + \sum_{i=1}^M \frac{Q_i(y-y_i)}{4\pi L_i \eta} \cdot \sum_{n=-\infty}^{\infty} \left[ \frac{1}{\left[ (x-x_i)^2 + (y-y_i)^2 + \frac{(z-2nb+d_i+L_i)^2}{A} \right]^{1/2} \left( \left[ (x-x_i)^2 + (y-y_i)^2 + \frac{(z-2nb+d_i+L_i)^2}{A} \right]^{1/2} + \frac{z-2nb+d_i+L_i}{(A)^{1/2}} \right)} - \frac{1}{\left[ (x-x_i)^2 + (y-y_i)^2 + \frac{(z-2nb+d_i)^2}{A} \right]^{1/2} \left( \left[ (x-x_i)^2 + (y-y_i)^2 + \frac{(z-2nb+d_i)^2}{A} \right]^{1/2} + \frac{z-2nb+d_i}{(A)^{1/2}} \right)} + \frac{1}{\left[ (x-x_i)^2 + (y-y_i)^2 + \frac{(z-2nb-d_i)^2}{A} \right]^{1/2} \left( \left[ (x-x_i)^2 + (y-y_i)^2 + \frac{(z-2nb-d_i)^2}{A} \right]^{1/2} + \frac{z-2nb-d_i}{(A)^{1/2}} \right)} - \frac{1}{\left[ (x-x_i)^2 + (y-y_i)^2 + \frac{(z-2nb-d_i-L_i)^2}{A} \right]^{1/2} \left( \left[ (x-x_i)^2 + (y-y_i)^2 + \frac{(z-2nb-d_i-L_i)^2}{A} \right]^{1/2} + \frac{z-2nb-d_i-L_i}{(A)^{1/2}} \right)} \right] \dots (17b)$$

$$v_z = \sum_{i=1}^M \frac{Q_i(A)^{1/2}}{4\pi L_i \eta} \sum_{n=-\infty}^{\infty}$$

$$\left[ \frac{1}{\left[ (x-x_i)^2 + (y-y_i)^2 + \frac{(z-2nb+d_i+L_i)^2}{A} \right]^{1/2}} - \frac{1}{\left[ (x-x_i)^2 + (y-y_i)^2 + \frac{(z-2nb+d_i)^2}{A} \right]^{1/2}} + \frac{1}{\left[ (x-x_i)^2 + (y-y_i)^2 + \frac{(z-2nb-d_i)^2}{A} \right]^{1/2}} - \frac{1}{\left[ (x-x_i)^2 + (y-y_i)^2 + \frac{(z-2nb-d_i-L_i)^2}{A} \right]^{1/2}} \right] \quad (17)$$

As with the drain equation, the infinite sum is truncated, summing over  $n$  from  $-N$  to  $N$ , where  $N$  is selected based upon desired accuracy. Again, as  $N$  increases,  $s$  goes to infinity, but the velocity components converge.

### Particle Tracking

Numerical integration techniques can be applied to trace particle paths in three dimensions by using the velocity vector equations. Starting with a particle at a known point  $(x, y, z)$ , the velocities  $(v_x, v_y, v_z)$  are computed and the particle is moved to a new position. Using the coordinates of the new position, a new value for the velocity vector is computed and the particle is moved again. This process is continued until the particle either passes downgradient or is captured by the extraction system.

A second-order Runge-Kutta numerical integration method described by Strack (1989) provides an effective means of tracking particles in three dimensions. Using this two-step procedure to track a particle located at  $(x, y, z)$ , first a *trial estimate* is made of the projected new position  $(x_t, y_t, z_t)$ , and then a second calculation is performed to determine a *final position*  $(x_f, y_f, z_f)$ . The procedure works as follows.

The coordinates of the trial position  $(x_t, y_t, z_t)$  are calculated using the following equations:

$$x_t = x + \Delta l \frac{v_x}{[v_x^2 + v_y^2 + v_z^2]^{1/2}} \quad (18a)$$

$$y_t = y + \Delta l \frac{v_y}{[v_x^2 + v_y^2 + v_z^2]^{1/2}} \quad (18b)$$

$$z_t = z + \Delta l \frac{v_z}{[v_x^2 + v_y^2 + v_z^2]^{1/2}} \quad (18c)$$

In these equations,  $\Delta l$  is a predetermined incremental step length. This is the distance the particle moves in each step of the calculation. Satisfactory results are usually obtained when the step length is less than one percent of the scale of the problem being investigated (such as the plume size or the length of the streamline). For typical problem solving, a step length of 1 to 5 feet is used.

New particle velocities,  $v_{xt}$ ,  $v_{yt}$ , and  $v_{zt}$  are then computed for the trial position  $(x_t, y_t, z_t)$  and a final position  $(x_f, y_f, z_f)$  is obtained using the following equations:

$$x_f = x + \Delta l \frac{v_x + v_{xt}}{[(v_x + v_{xt})^2 + (v_y + v_{yt})^2 + (v_z + v_{zt})^2]^{1/2}} \quad (19a)$$

$$y_f = y + \Delta l \frac{v_y + v_{yt}}{[(v_x + v_{xt})^2 + (v_y + v_{yt})^2 + (v_z + v_{zt})^2]^{1/2}} \quad (19b)$$

$$z_f = z + \Delta l \frac{v_z + v_{zt}}{[(v_x + v_{xt})^2 + (v_y + v_{yt})^2 + (v_z + v_{zt})^2]^{1/2}} \quad (19c)$$

The final position  $(x_f, y_f, z_f)$  is a distance,  $\Delta l$ , from the initial position  $(x, y, z)$ . The entire calculation process is repeated, then using  $(x_f, y_f, z_f)$  as the starting point and the particle is stepped again. By repeating this process dozens or hundreds of times for a given particle, it is possible to determine its entire path and whether it escapes or is captured. By examining many particles in this manner, it is possible to determine areas where capture occurs, as well as areas outside the capture zone.

### Calculations

Calculations of drawdown, velocity, and particle tracking described above were performed for drains and wells to illustrate the efficacy of this method. The solution was coded in Fortran 77. The procedure was to track a family of particles starting from the same  $x$  coordinate, i.e., particles in a single vertical plane perpendicular to the  $x$  axis, and determine their travel paths in three dimensions.

For each particle, a determination was made as to whether or not capture occurred. For those particles that were captured, the starting coordinates were saved to an output file for subsequent plotting. The output file was imported to a spreadsheet and a section view plot of the capture zone profile was made. By repeating this procedure for other  $x$  coordinates, it was possible to obtain capture zone information at several locations along the plume.

One approach involved tracking uniformly spaced particles covering a rectangular area of specified dimensions perpendicular to the  $x$  axis. The resulting output, when plotted, showed the profile of the capture zone as a solid, shaded area. This "gridding" approach was computationally intensive, because a large number of particles were tracked.

Another approach (used in the examples presented below) reduced run time by searching for points near the outer boundary of the capture profile and calculated the coordinates of just the outermost captured points. Run time was reduced because far fewer interior points were tracked. The output file, when plotted, traced the outer boundary of the capture zone profile in section view perpendicular to the  $x$  axis. The tracing algorithm sometimes did not perform well for complicated capture zone

18 31

2 35

profiles that can form around multiple well systems. In these instances, gridding should be used instead of tracing.

## Results

Example capture zones were computed for an idealized aquifer having a hydraulic conductivity of 10 ft/day and a uniform gradient of 0.01 in the positive x direction. Initial calculations were made for a 200-foot long drain 5 feet below the top of the aquifer, running parallel to the y axis as shown in Figure 1.

Results of the calculations are diagrammed in Figure 5. The graph in the upper left shows the cross-sectional outline of the capture zone around the drain assuming a flow rate of 5 gpm and isotropic conditions. The capture zone outline is shown at an x coordinate value of zero, that is, in a plane passing through the drain perpendicular to the x axis. It is clear that the discharge rate of 5 gpm would be adequate for recovering a contamination plume extending about 20 feet below the top of the aquifer.

The graph in the upper right shows the capture zone for the same flow rate and anisotropy ratio, but for several different x coordinate values. The downgradient limit of capture extended just beyond 13 feet and the cross-sectional area of capture increased steadily in the upgradient direction.

The graph in the lower left shows the capture zone profile at  $x = 0$  for flow rates of 2, 5, and 10 gpm. Note that at a flow rate of 2 gpm, the capture zone no longer extended to the top of the aquifer.

The graph in the lower right shows the effects of anisotropy ratio on the shape of the capture zone. As the anisotropy became more severe, the capture zone became shallower and wider.

Figure 6 shows the results of capture zone calculations for three vertical wells located along the y axis, completed to a depth of 25 feet, and spaced 75 feet apart. The graph in the upper left shows the capture zone for a flow rate of 3 gpm per well and isotropic conditions. The capture zone corresponds to an x coordinate of zero, that is, the plane passing through the wells, perpendicular to the x axis. Clearly this pumping scheme would not be adequate for plume capture because there were distinct gaps between the capture zones for each well.

The graph in the upper right shows additional capture zone profiles for other x coordinate values. The downgradient limit of capture extended a little past 25 feet and the gaps in the capture system extended upgradient.

The lower left graph shows how the capture zone profile changed with increasing discharge rate. At flow rates of 6 gpm

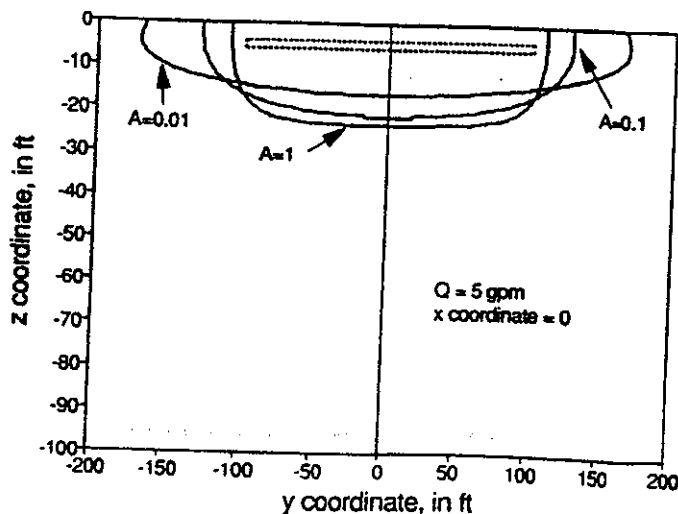
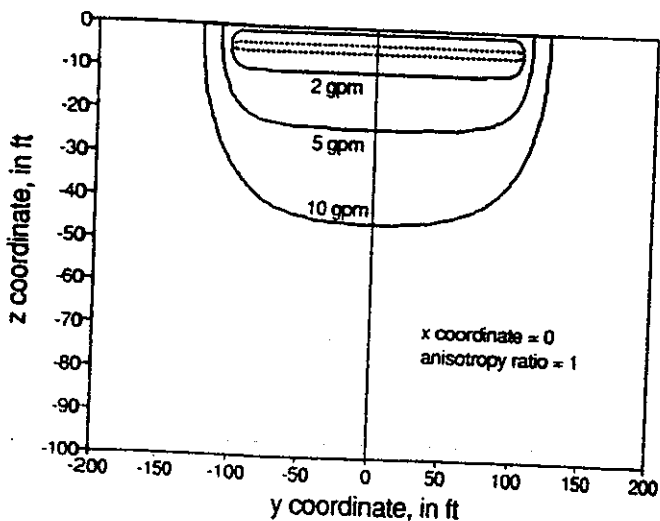
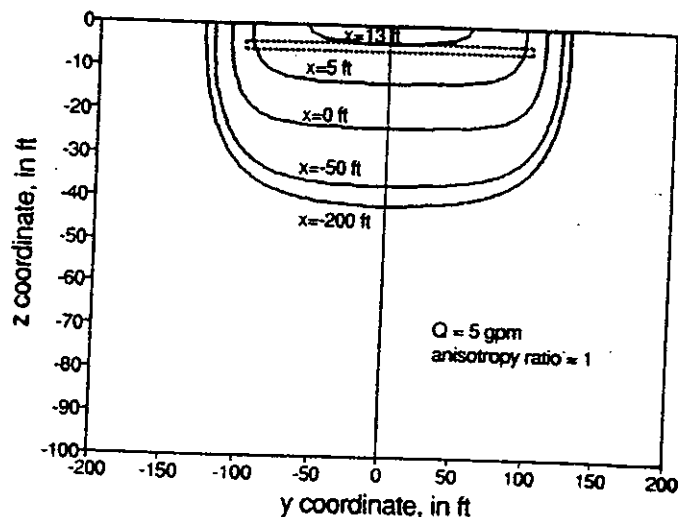
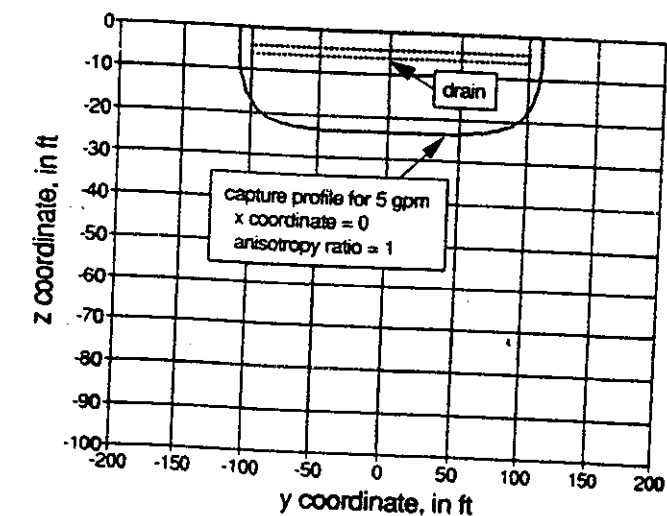

Fig. 5. Capture zone profiles around horizontal drain.

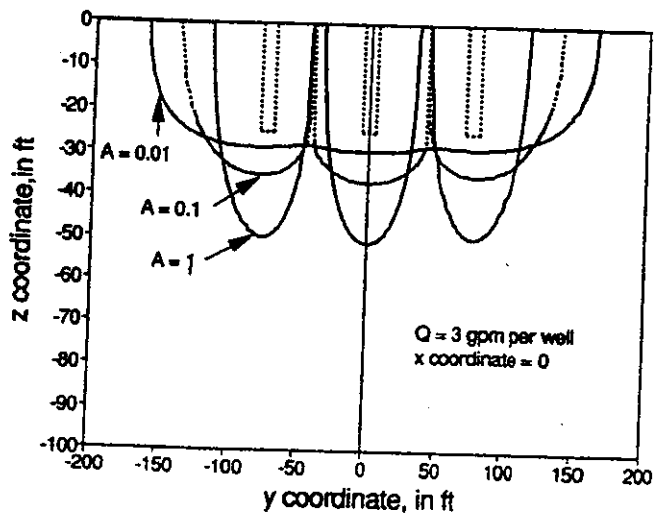
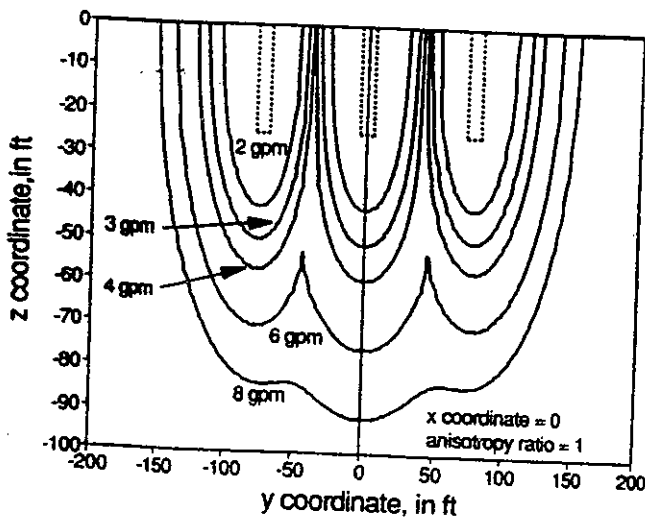
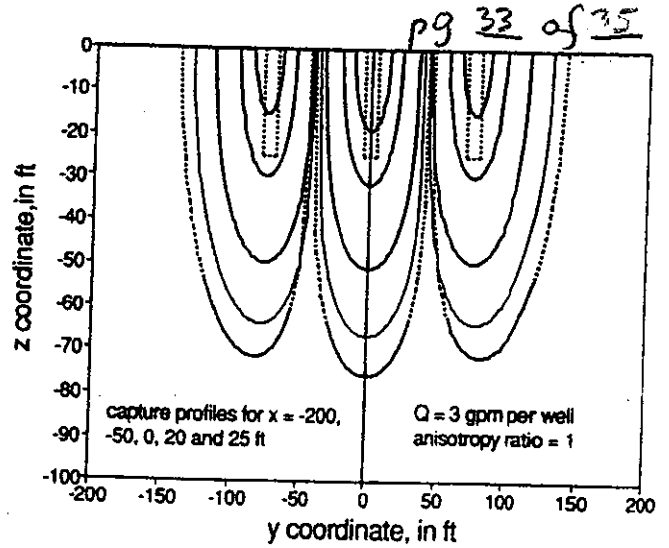
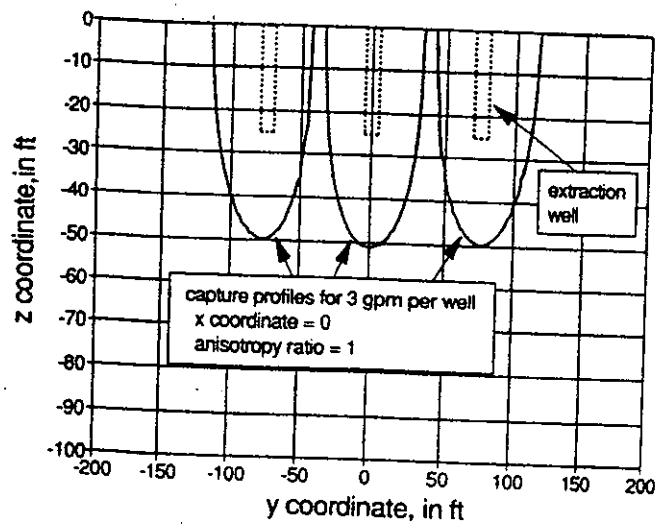

Fig. 6. Capture zone profiles around multiple partially penetrating extraction wells.

per well and greater, the leaks in the capture zone were eliminated.

The lower right graph again shows that increasingly severe anisotropy ratio caused the capture zones to widen. Note that for an anisotropy ratio of 0.01, the leaks vanished.

As a check on the accuracy of this calculation method, it was used to compute capture zones that could be verified with simple analytical equations so that the results could be compared. First, capture zones were calculated for a fully penetrating well assuming a hydraulic conductivity of 10 ft/day, an aquifer thickness of 80 feet, a gradient of 0.01, and a discharge rate of 10 gpm (1,925 ft<sup>3</sup>/day). The applicable analytical equation is as follows (Javandel and Tsang, 1986):

$$W_0 = \frac{Q}{2KI} \quad (20)$$

where  $W_0$  = capture width at the well, in ft;  $Q$  = discharge, in ft<sup>3</sup>/day;  $K$  = hydraulic conductivity, in ft/day;  $b$  = aquifer thickness, in ft; and  $I$  = hydraulic gradient. Using this equation, the expected capture width at the well is 120.3 feet, and thus should extend from  $y = -60.15$  ft to  $y = 60.15$  ft.

The left-hand graph in Figure 7 shows the capture zone prediction using the 3D method for assigned values of  $N$  of 2 and

10, where  $N$  represents the truncation of the summation term in equations (17a), (17b), and (17c). The calculated capture zone corresponding to  $N = 2$  (solid line) underpredicted the capture zone by a few tenths of a foot. The predicted capture zone for  $N = 10$  (dashed line) was highly accurate, predicting capture for points within 60.1 feet of the well and demonstrating noncapture for points 60.2 feet and farther from the well.

A second check was made on the 3D method by comparing its output to the expected capture zone around a point sink placed at the top of an infinitely thick aquifer. For isotropic conditions, the expected capture zone would be a half circle of area  $a$  where

$$a = \frac{1}{2} \pi r^2 \quad (21)$$

where  $r$  = radius of the semicircle of capture. With the point sink at the origin of the coordinate system, the capture zone profile in the  $y, z$  plane ( $x = 0$ ) would satisfy the following equation:

$$Q = 2KIa \quad (22)$$

Combining equations (21) and (22), the expected radius of the semicircular capture profile is

$$r = \left[ \frac{Q}{\pi KI} \right]^{1/2} \quad (23)$$

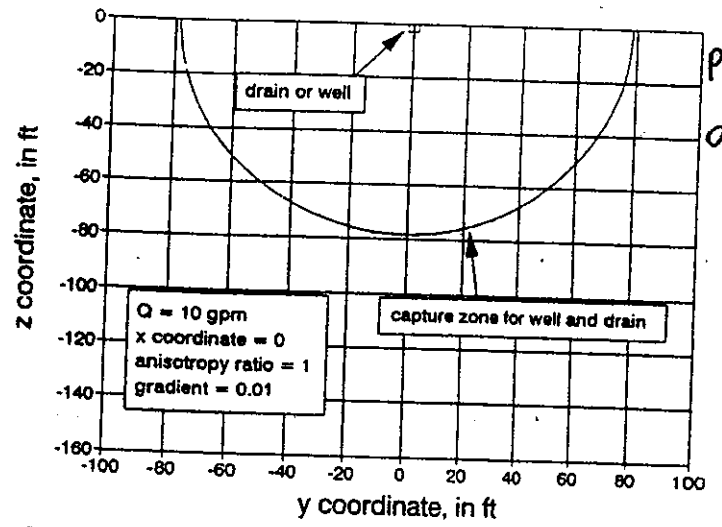
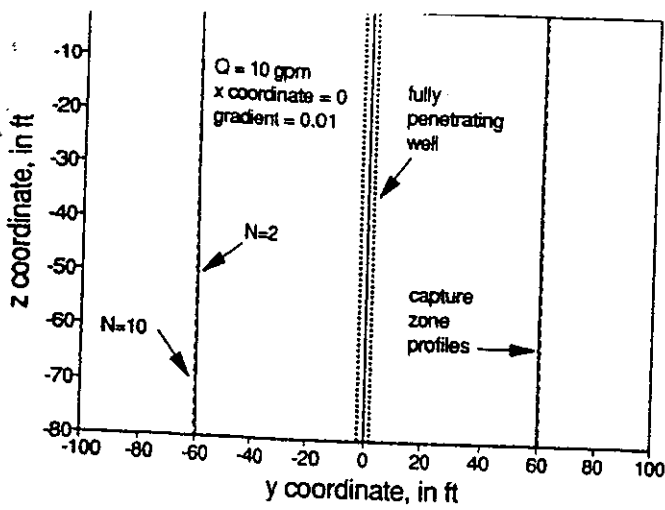

Fig. 7. Capture zone profiles for fully penetrating well (left) and well or drain of negligible length (right).

By using the same flow rate, hydraulic conductivity, and hydraulic gradient as in the previous example, the calculated value of  $r$  was 78.28 feet.

3D capture zone profiles were computed for these assumed conditions for a 1-foot long drain centered at the origin and a 1-foot deep well located at the origin. Calculations were performed by assigning  $N=0$  in equations (13a), (13b), (13c), (17a), (17b), and (17c), effectively truncating the infinite sum to a single term. This is mathematically equivalent to assuming that the aquifer is infinitely deep. The right-hand graph in Figure 7 shows plots of the capture zone for the short drain, the capture zone for the short well, and a semicircle of radius 78.28 feet. The three plots coincide, demonstrating the accuracy of the 3D method.

The section views of the capture zones shown above are generally the most useful presentation for determining exact

dimensions of capture zones and establishing rigorous comparison to known plume dimensions. Occasionally, however, it is helpful to be able to visualize what the capture zone looks like using a three-dimensional plot. This is accomplished by computing the capture profile for a large number of  $x$  coordinate values and plotting them simultaneously using appropriate software. Figure 8 shows such a 3D plot for the capture zone of a single partially penetrating pumped well. By viewing the capture zone from the front, from the side, and at an angle, it is possible to get a clearer understanding of the area of contribution to the extraction system.

Figure 9 shows another 3D plot of the capture zone for a three-well system. This 3D plot was computed using the same inputs as those used for the 6 gpm graph shown in the lower left portion of Figure 6. Figure 9 provides a better overall under-

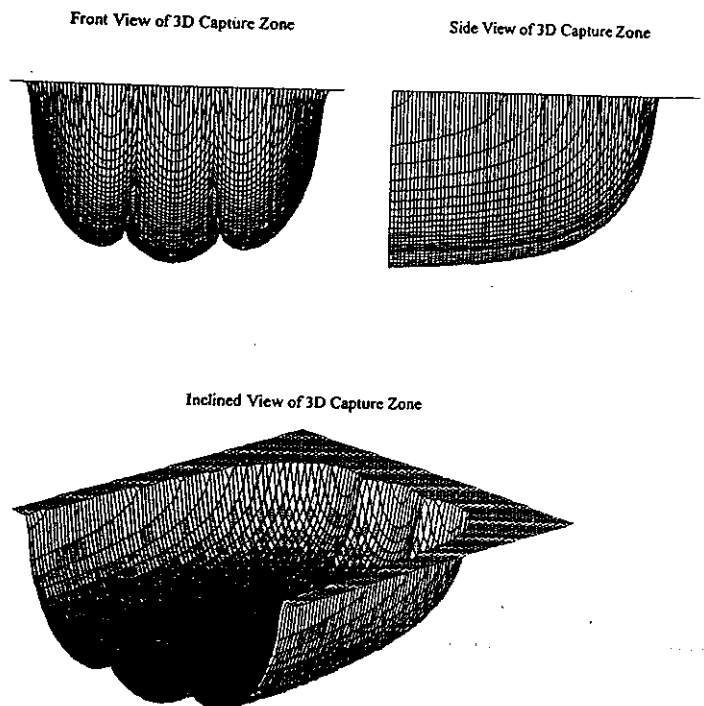
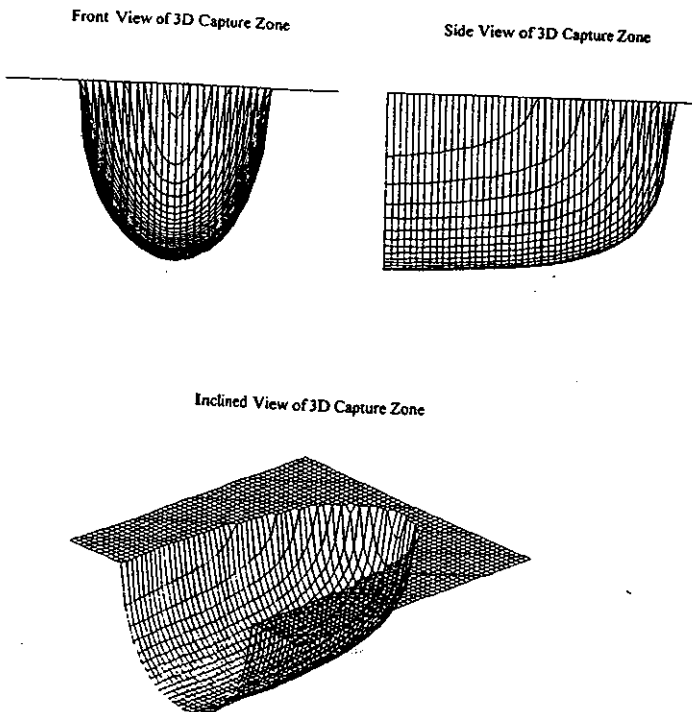

Fig. 8. 3D capture zone around a single partially penetrating well.

Fig. 9. 3D capture zone around a three-well extraction system.

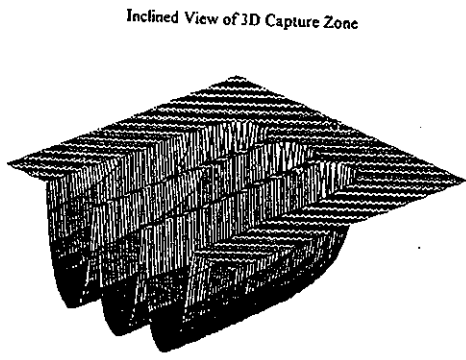
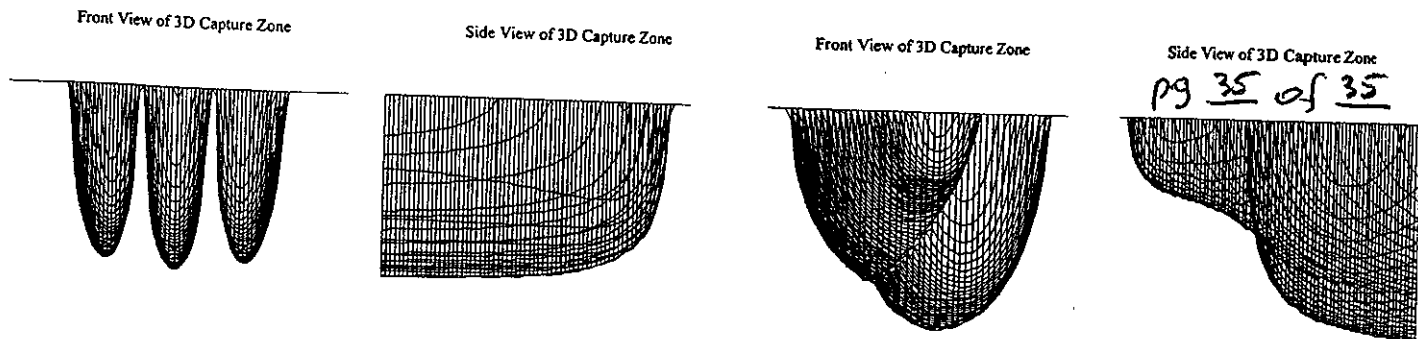

Fig. 10. 3D capture zone showing leaks between wells.

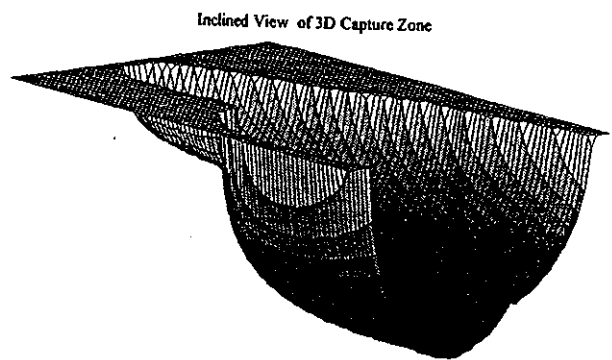

Fig. 11. 3D capture zone for two-well extraction system.

standing of the nature of the shape of the capture zone, whereas Figure 6 is more useful for determining specific dimensions.

Figure 10 shows the same three-well system but at a discharge rate of 3 gpm per well. Leaks in the capture zone are clearly evident. This 3D plot was computed with the same inputs as those used for the 3-gpm graphs shown in the left portion of Figure 6.

Figure 11 shows the 3D capture zone calculated for a two-well recovery system at a site in Southern California. The extraction system consisted of a 1-gpm well located 300 feet downgradient (and slightly cross gradient) from a 5-gpm well. The figure shows that the downgradient lobe of capture is smaller than the upgradient portion of the capture zone because of the difference in the flow rates of the two wells.

**Conclusions**

The method presented for determining capture zones in three dimensions is useful for guiding the design, placement, and operation of extraction systems for contaminant plumes that partially penetrate thick aquifers. 2D solutions assume the capture zones to be fully penetrating, and thus overestimate the

quantity of flow necessary to achieve capture. 3D flow models on the other hand, are expensive to implement and suffer some loss of accuracy because the thick aquifer must be subdivided into a small number of discrete layers. Furthermore, depending on the grid spacing used, numerical 3D models can lack the sensitivity required to detect small leaks between components of the extraction system.

The 3D method described here provides an exact solution for determining 3D capture zones around wells and drains in homogeneous, anisotropic aquifers in a uniform flow field.

**References**

Harr, M. E. 1962. Groundwater and Seepage. McGraw-Hill Book Company, New York.  
 Javandel, Iraj and Chin-Fu Tsang. 1986. Capture-zone type curves: A tool for aquifer cleanup. Ground Water. v. 24, no. 5.  
 Philip, Ross D. and Gary R. Walter. 1992. Prediction of flow and hydraulic head fields for vertical circulation wells. Ground Water. v. 30, no. 5.  
 Shan, Chao, Ronald W. Falta, and Iraj Javandel. 1992. Analytical solutions for steady state gas flow to a soil vapor extraction well. Water Resources Research. v. 28, no. 4.  
 Strack, Otto D. L. 1989. Groundwater Mechanics. Prentice Hall, Englewood Cliffs, NJ.

CALCULATION COVER SHEET

Client: NYSDEC Project Name: Kliegman OU2

Project/Calculation Number: \_\_\_\_\_

Title: Estimate of PCE mass in plume

Total Number of Pages (including cover sheet): 7

Total Number of Computer Runs: 1

Prepared by: Jon Sundquist Date: \_\_\_\_\_

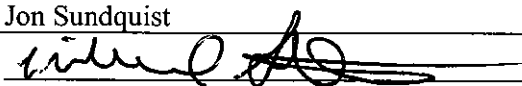
Checked by:  Date: 9/17/07

Description and Purpose:  
Estimate amount of PCE in the Plume

Design Basis/References/Assumptions  
Shallow Groundwater Well Concentrations  
Assumes 2-meter depth of plume.

Remarks/Conclusions/Results:  
About 500 kg in the 10-ppm contour, up to about 600 kg out to 1-ppm contour

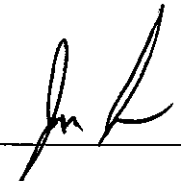
Calculation Approved by:  9/18/07  
Project Manager/Date

Revision No.:	Description of Revision:	Approved by:
_____	_____	_____
_____	_____	_____
_____	_____	_____

Project Manager/Date

Job Kliegman OU2 Feasibility Study  
 Description Estimate of PCE Mass in Plume

Project No. 11174770  
 Computed by Jon Sundquist  
 Checked by \_\_\_\_\_

Page 1 of 6  
 Sheet \_\_\_\_\_ of \_\_\_\_\_  
 Date \_\_\_\_\_  
 Date \_\_\_\_\_

Reference

Objective: Estimate Mass of PCE in Kliegman Plume, including mass between the 1 mg/L and 10 mg/L contours.

References: GW results in project database

### Calculations:

Plume is 3D, but interpolating using GRASS among 3D points available (see Figure 1) gives misleading results because there just aren't enough points. Specifically, there are no bounding points below or even on periphery to provide sufficient differentiation.

So instead, look at just the water Table concentrations and interpolate on a 2D basis, then assume depth.

The Water Table well data (latest available). There are 7 wells with elevation of 82 feet on Table 1.

That was interpolated in GRASS. A 3D view of the interpolated surface, cropped/masked to the 1,000 ug/L is shown on Figure 2 (note, where the interpolation assigned negative values to portions of the plume north of the site, a value of 1,000 ug/L was assigned to those areas.)

The concentration of the interpolated surface was outputted into discrete  $\sim 10 \text{ m}^2$  squares, the distribution of concentrations of these squares is shown on figure 3.

cont'd →



The average concentration of these squares (calculated by spreadsheet) is 12,984 ug/L

With an area of ~ 64,000 m<sup>2</sup>

and an assumed depth of plume of 2 meters  
and an assumed porosity of 30%

Total dissolved mass is

$$(0.30) \left( \frac{12,984 \text{ ug}}{\text{L}} \right) (64,000 \text{ m}^2) (2 \text{ m depth}) \left( \frac{1000 \text{ L}}{\text{m}^3} \right) \left( \frac{\text{Kg}}{10^6 \text{ ug}} \right) \approx 500 \text{ Kg}$$

However, my gut feeling is the distribution underestimates the source area mass because high concentrations are deeper here, and there may be some DNAPL that is not accounted for by the dissolved phase concentrations.

(note, for comparison, 17,700 kg have been recovered by SVE from this zone)

Now estimate between 1,000 ug/L and 10,000 ug/L.

Assume: concentration in this zone is geometric average of 1,000 and 10,000 ug/L  
depth of plume is 2 meters

area of 10,000 isocountour is ~ 16,400 m<sup>2</sup>, porosity = 0.30

so annulus between the two is: 47,600 m<sup>2</sup>

$$\text{Mass is: } \left( \frac{\sqrt{10,000 \times 1,000} \text{ ug}}{\text{L}} \right) (47,600 \text{ m}^2) (2 \text{ m}) \left( \frac{1000 \text{ L}}{\text{m}^3} \right) \left( \frac{\text{Kg}}{10^6 \text{ ug}} \right) (0.3) = 40 \text{ Kg}$$

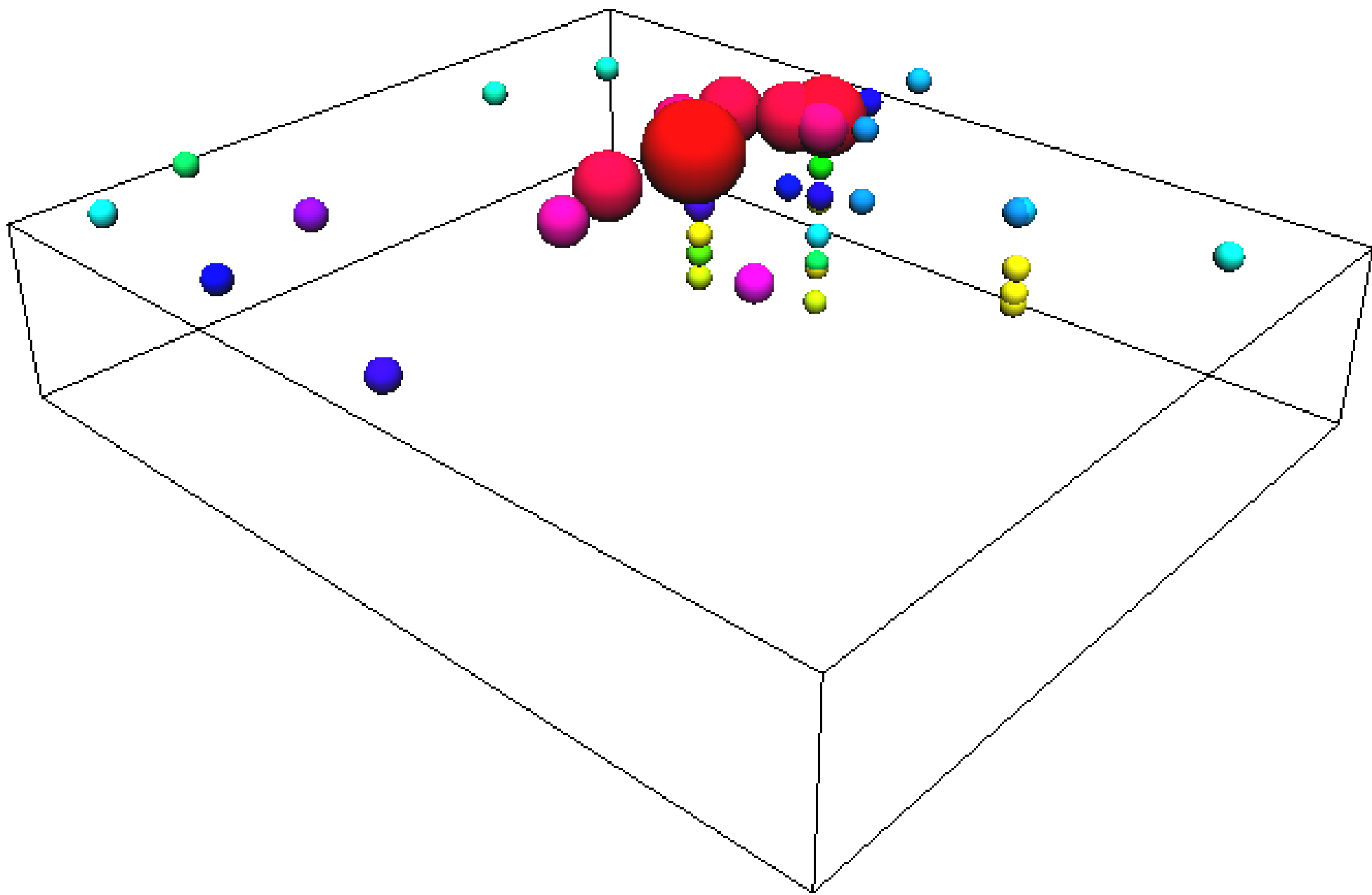

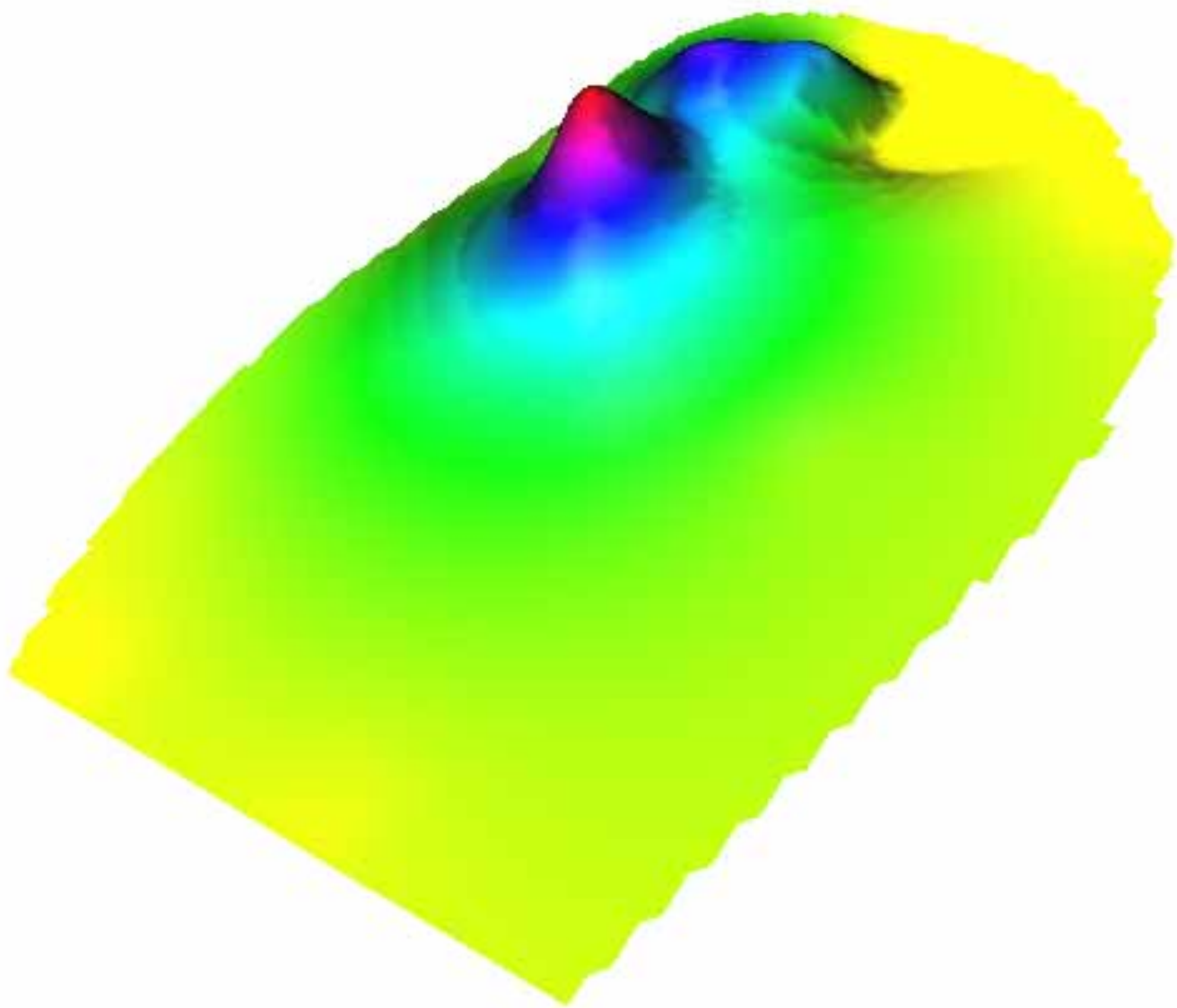

Figure 3

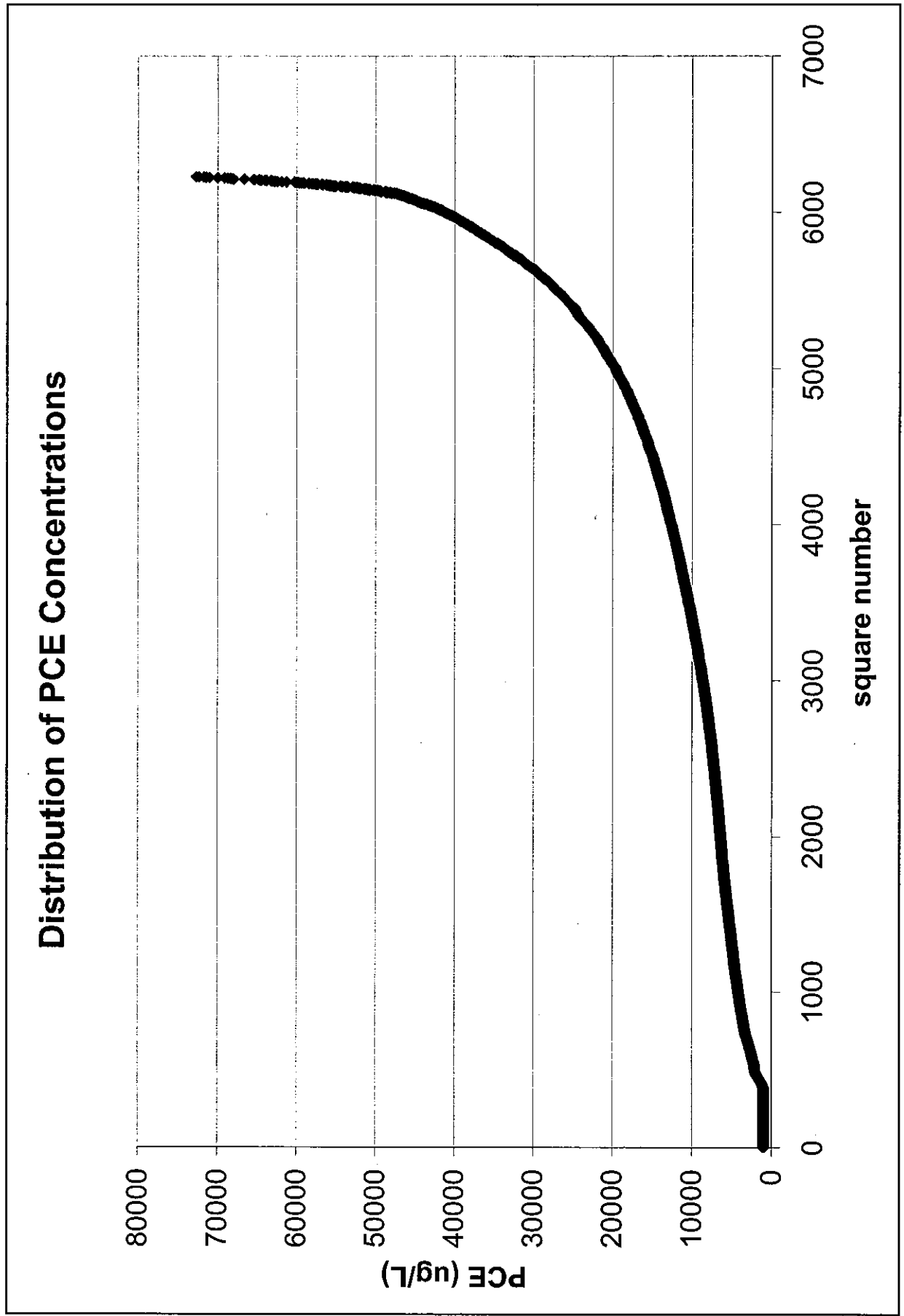

Table 1 - Latest GW wells, their coordinates, screen elevations, PCE concentrations, and names.

1019259	196889.3	82	2600 MW-02D
1019146	196749.4	82	43000 MW-03D
1019197	196622.7	82	75000 MW-04D
1019127	196677.5	82	17000 MW-05D
1019127	196677.5	82	31000 MW-05D
1019580	196739.6	82	1200 MW-07D
1019247	196815.1	82	55000 MW-10D
1019242	196814.8	82	24800 MW-10H
1019264	196990.7	82	920 MW-11D
1019205	196625.9	82	51200 MW-12H
1019583	196744.3	82	809 MW-13H
1019189	196483.6	82	40000 MW-14D
1018929	196750.2	82	310 MW-15D
1019808	196798.9	82	350 MW-16D
1019472	196411.9	82	8400 MW-17D
1018998	196205.5	82	5700 MW-18D
1019049	196043.4	82	2300 MW-19D
1018822	196052.4	82	370 MW-20D
1018883	196590.9	82	300 MW-21D
1018778	196193	82	190 MW-22D
1019331	196031.9	82	3400 MW-23D
1019218	196382.8	82	21000 MW-24D
1019215	196784.6	82	45000 SVE-2
1019215	196784.6	82	2200 SVE-2
1019261	196790.7	82	30000 SVE-3
1019261	196790.7	82	2800 SVE-3
1019310	196814.1	82	1200 SVE-4
1019310	196814.1	82	1200 SVE-4
1019242	196814.8	60	75 MW-10H
1019242	196814.8	45	11 MW-10H
1019242	196814.8	30	540 MW-10H
1019242	196814.8	16	0 MW-10H
1019242	196814.8	0	16 MW-10H
1019205	196625.9	60	3790 MW-12H
1019205	196625.9	40	51 MW-12H
1019205	196625.9	30	16 MW-12H
1019583	196744.3	60	0 MW-13H
1019583	196744.3	46	1 MW-13H
1019242	196814.8	18	180 MW-10H
1019205	196625.9	48	0 MW-12H
1019583	196744.3	50	0 MW-13H
1019215	196784.6	52	2200 SVE-2
1019261	196790.7	52	2800 SVE-3
1019310	196814.1	52	1200 SVE-4

water table wells  
↑

**APPENDIX B**  
**COST ESTIMATES**



**URS CORPORATION**  
**ENGINEER'S COST ESTIMATE**  
**ESTIMATED UNIT COST**

Client: NYSDEC	Project Number: 11174770	Date: 2-Jul-07
Project: Kliegman Bros. Site	Calculated By: AMM	
Title: Alternative 1 - Annual Operation and Maintenance - 30 Year Period	Checked By: J. Sundquist	Date: 2-Jul-07

ITEM	DESCRIPTION	QTY.	UNITS	UNIT COST	TOTAL COST
1	Air monitoring - Labor 2 days/event * 2 events /yr	40	manhour	\$60.00	\$2,400
2	Sub-slab depressurization installation	3	yr	\$3,500.00	\$10,500
3	Reports	1	ls	\$2,500.00	\$2,500
4					
5					
6					
7					
8					
9					
10				<b>SUBTOTAL</b>	<b>\$15,400</b>
11	<b>LOCATION COST ADJUSTMENT FACTOR - QUEENS, NY</b>			<b>1.269</b>	<b>\$19,543</b>
12					
13					
14					
15					
16					
17					
18					
19					
20					
21					
22					
23					
24					
25					
26					
27					
28				<b>Subtotal</b>	<b>\$19,543</b>
29				<b>Contractors Overhead and Profit</b>	<b>25%</b>
30				<b>Subtotal</b>	<b>\$4,886</b>
31				<b>Contingency</b>	<b>30%</b>
32				<b>Subtotal</b>	<b>\$7,328</b>
33				<b>Present Worth (30 yr. @ 5% discount)</b>	<b>15.373</b>
34					
<b>TOTAL COST:</b>					<b>\$488,200</b>



**NYSDEC  
 KLIEGMAN BROTHERS SITE  
 FEASIBILITY STUDY  
 ENGINEER'S COST ESTIMATE**

Client:	NYSDEC	Project Number:	11174770
Project:	Kliegman Brothers Site - OU2	Calculated By:	P. Baker
Date:			2-Jul-07
Description:	Alternative 2A - Concentrated Plume Extraction and Treatment	Checked By:	J. Sundquist
Date:			2-Jul-07

**SUMMARY**

DESCRIPTION	ESTIMATED COST
<b>Mobilization and Demobilization</b>	<b>\$46,769</b>
<b>Extraction Well Installation</b>	<b>\$140,925</b>
<b>Ground Water Treatment System</b>	<b>\$493,493</b>
<b>SUBTOTAL</b>	<b>\$681,187</b>

**STANDARD SUPPLEMENTAL PROJECT COSTS**

<b>Overhead and Profit 25.00%</b>	<b>\$170,297</b>
<b>SUBTOTAL</b>	<b>\$851,483</b>
<b>Contingency 30.00%</b>	<b>\$255,445</b>
<b>SUBTOTAL CONSTRUCTION COSTS</b>	<b>\$1,106,928</b>
<b>Engineering Design 10%</b>	<b>\$110,693</b>
<b>TOTAL CAPITAL COST</b>	<b>\$1,217,621</b>
<b>Annual Operation and Maintenance Cost</b>	<b>\$5,020,700</b>
<b>ALTERNATIVE 2A - TOTAL COST</b>	<b>\$6,238,321</b>
<b>TOTAL BUDGETARY COST</b>	<b>\$6,239,000</b>

# URS CORPORATION

## CONSTRUCTION COST ESTIMATE

### ESTIMATED UNIT COST

Client: NYSDEC	Project Number: 11174770	Date: 29-Oct-06
Project: Kliegman Brothers Site - OU2	Calculated By: P. Baker	
Title: Alternative 2A - Mobilization/Demobilization	Checked By: J. Sundquist	Date: 2-Nov-06

ITEM	DESCRIPTION	QTY.	UNITS	UNIT COST	TOTAL COST
1	Submittals				
2	Health and Safety Plan	1	ls	\$2,500.00	\$2,500
3	Shop drawings	1	ls	\$2,500.00	\$2,500
4	Schedules	1	ls	\$3,000.00	\$3,000
5	Record drawings	1	ls	\$2,500.00	\$2,500
6	Survey	2	day	\$1,186.00	\$2,372
7	Security fence	250	lf	\$53.94	\$13,485
8	Permits and easements - Allowance	1	ls	\$20,000.00	\$20,000
9	Portable toilet	2	mo	\$206.00	\$412
10					
11					
12					
13					
14					
15					
16					
17					
18					
19					
20					
21					
22					
23					
24					
25					
26					
27					
28					
29					
30					
31					
32					
33					
34					
35					
36					
<b>TOTAL COST:</b>					<b>\$46,769</b>

**URS CORPORATION**  
**CONSTRUCTION COST ESTIMATE**  
**ESTIMATED UNIT COST**

Client: NYSDEC	Project Number: 11174770	Date: 29-Oct-06
Project: Kliegman Brothers Site - OU2	Calculated By: P. Baker	
Title: Alternative 2A - Ground Water Recovery Well Installation	Checked By: J. Sundquist	Date: 2-Nov-06

ITEM	DESCRIPTION	QTY.	UNITS	UNIT COST	TOTAL COST
1	Sawcut pavement	1100	lf	\$2.02	\$2,222
2	Excavation - trench and vault	1100	lf	\$9.60	\$10,560
3	Extraction well installation	80	vlf	\$186.00	\$14,880
4	Precast concrete vault with road cover - 6' x 6' x 6'	1	ea	\$4,875.00	\$4,875
5	Pipe bedding	2,200	lf	\$1.79	\$3,938
6	Discharge line - 4" HDPE pipe	550	lf	\$9.50	\$5,225
7	Pump - 10 HP, 150 gpm , 80' head	1	ea	\$4,800.00	\$4,800
8	Electrical conduit - 2" PVC	550	lf	\$20.00	\$11,000
9	Pump - electric and controls - Allowance:	1	ls	\$13,000.00	\$13,000
10	Pump - pipe, valves, fittings - Allowance:	1	ls	\$3,000.00	\$3,000
11	Pavement restoration	300	sy	\$25.84	\$7,752
12	Traffic control - Allowance	4	wk	\$7,000.00	\$28,000
13	Drill cuttings disposal	6	drum	\$300.00	\$1,800
14				<b>SUBTOTAL</b>	<b>\$111,052</b>
15				<b>LOCATION COST ADJUSTMENT FACTOR - QUEENS, NY</b>	<b>1.269</b>
16					
17					
18					
19					
20					
21					
22					
23					
24					
25					
26					
27					
28					
29					
<b>TOTAL COST:</b>					<b>\$140,925</b>

**URS CORPORATION**  
**CONSTRUCTION COST ESTIMATE**  
**ESTIMATED UNIT COST**

Client: NYSDEC	Project Number: 11174770	
Project: Kliegman Brothers Site - OU2	Calculated By: P. Baker	Date: 29-Oct-06
Title: Alternative 2A - Ground Water Treatment System	Checked By: J. Sundquist	Date: 2-Nov-06

ITEM	DESCRIPTION	QTY.	UNITS	UNIT COST	TOTAL COST
1	Air stripper - horiz.tray , 300 GPM w / blower and controls	1	ea	\$54,000.00	\$54,000
2	Vapor phase carbon adsorber unit	1	ea	\$15,483.00	\$15,483
	Activated carbon - initial charge and yr 1 changeouts	76,500	lb	\$2.60	\$198,900
3	System controls	1	ea	\$20,000.00	\$20,000
4	Electrical power drop - 230V - 3 phase within 50'	1	ls	\$20,000.00	\$20,000
5	Electrical installation	1	ls	\$13,000.00	\$13,000
6	Natural gas connection ( within 50')	1	ls	\$15,000.00	\$15,000
7	Sanitary sewer discharge connection (within 50')	1	ls	\$15,000.00	\$15,000
8	Installation, including pipe, valves, fittings - Allowance:	1	ls	\$14,000.00	\$14,000
9	System startup	1	ls	\$20,000.00	\$20,000
10	Concrete pad - 25' x 10' x 1'	10	cy	\$350.00	\$3,500
11				<b>SUBTOTAL</b>	<b>\$388,883</b>
12					
13					
14	<b>LOCATION COST ADJUSTMENT FACTOR - QUEENS, NY</b>			<b>1.269</b>	<b>\$493,493</b>
15					
16					
17					
18					
19					
20					
21					
22					
23					
24					
25					
26					
27					
28					
29					
30					
31					
<b>TOTAL COST:</b>					<b>\$493,493</b>

**URS CORPORATION**  
**ENGINEER'S COST ESTIMATE**  
**ESTIMATED UNIT COST**

Client: NYSDEC	Project Number: 11174770	Date: 2-Jul-07
Project: Kliegman Bros. Site	Calculated By: PB	
Title: Alternative 2A - Annual Operation and Maintenance - 30 Year Period	Checked By: J. Sundquist	Date: 2-Jul-07

ITEM	DESCRIPTION	QTY.	UNITS	UNIT COST	TOTAL COST
1	Monitoring Well Sampling - Labor: 4 wells / day @ 20 mhr	180	man hour	\$60.00	\$10,800
2	Sample Analysis: Annual	36	each	\$150.00	\$5,400
3	Air monitoring - Labor 2 days/event * 2 events/yr	40	man hour	\$60.00	\$2,400
4	Sub-slab depressurization installation	3	yr	\$3,500.00	\$10,500
5	Reports	1	ls	\$2,500.00	\$2,500
6	Repair Security Fence - Allowance	1	ls	\$250.00	\$250
7	Groundwater treatment plant operation - Allow:	12	month	\$5,500.00	\$66,000
8	Pumping system repairs / maintenance - Allow	1	ls	\$5,000.00	\$5,000
9	Utilities - Electricity: Allowance	1	year	\$8,841.00	\$8,841
10	Activated carbon, including changeout and regeneration	14,000	lb/yr	\$2.05	\$28,684
11	Sanitary sewer discharge	12	month	\$1,500.00	\$18,000
10				<b>SUBTOTAL</b>	<b>\$158,375</b>
11	<b>LOCATION COST ADJUSTMENT FACTOR - QUEENS, NY</b>		<b>\$158,375</b>	<b>1.269</b>	<b>\$200,978</b>
12					
13					
14					
15					
16					
17					
18					
19					
20					
21					
22					
23					
24					
25					
26					
27					
28				<b>Subtotal</b>	<b>\$200,978</b>
29				<b>Contractors Overhead and Profit</b>	<b>25%</b>
30				<b>Subtotal</b>	<b>\$251,222</b>
31				<b>Contingency</b>	<b>30%</b>
32				<b>Subtotal</b>	<b>\$326,589</b>
33				<b>Present Worth (30 yr. @ 5% discount)</b>	<b>15.373</b>
34					
	<b>TOTAL COST:</b>				<b>\$5,020,700</b>

**NYSDEC  
 KLIEGMAN BROTHERS SITE  
 FEASIBILITY STUDY  
 ENGINEER'S COST ESTIMATE**

Client: NYSDEC	Project Number: 11174770	
Project: Kliegman Brothers Site - OU2	Calculated By: P. Baker	Date: 2-Jul-07
Description: Alternative 2B - Expanded Plume Extraction and Treatment	Checked By: J. Sundquist	Date: 30-Jan-08

**SUMMARY**

DESCRIPTION	ESTIMATED COST
<b>Mobilization and Demobilization</b>	<b>\$46,769</b>
<b>Extraction Well Installation</b>	<b>\$198,758</b>
<b>Ground Water Treatment System</b>	<b>\$348,319</b>
<b>SUBTOTAL</b>	<b>\$593,846</b>

**STANDARD SUPPLEMENTAL PROJECT COSTS**

<b>Overhead and Profit 25.00%</b>	<b>\$148,462</b>
<b>SUBTOTAL</b>	<b>\$742,308</b>
<b>Contingency 30.00%</b>	<b>\$222,692</b>
<b>SUBTOTAL CONSTRUCTION COSTS</b>	<b>\$965,000</b>
<b>Engineering Design 10%</b>	<b>\$96,500</b>
<b>TOTAL CAPITAL COST</b>	<b>\$1,061,500</b>
<b>Annual Operation and Maintenance Cost</b>	<b>\$5,215,537</b>
<b>ALTERNATIVE 2B - TOTAL COST</b>	<b>\$6,277,037</b>
<b>TOTAL BUDGETARY COST</b>	<b>\$6,278,000</b>

**URS CORPORATION**  
**CONSTRUCTION COST ESTIMATE**  
**ESTIMATED UNIT COST**

Client: NYSDEC	Project Number: 11174770	Date: 29-Sep-06
Project: Kliegman Brothers Site - OU2	Calculated By: P. Baker	Date: 29-Sep-06
Title: Alternative 2B - Mobilization/Demobilization	Checked By: J. Sundquist	Date: 2-Nov-06

ITEM	DESCRIPTION	QTY.	UNITS	UNIT COST	TOTAL COST
1	Submittals				
2	Health and Safety Plan	1	ls	\$2,500.00	\$2,500
3	Shop drawings	1	ls	\$2,500.00	\$2,500
4	Schedules	1	ls	\$3,000.00	\$3,000
5	Record drawings	1	ls	\$2,500.00	\$2,500
6	Survey	2	day	\$1,186.00	\$2,372
7	Security fence	250	lf	\$53.94	\$13,485
8	Permits and easements - Allowance	1	ls	\$20,000.00	\$20,000
9	Portable toilet	2	mo	\$206.00	\$412
10					
11					
12					
13					
14					
15					
16					
17					
18					
19					
20					
21					
22					
23					
24					
25					
26					
27					
28					
29					
30					
31					
32					
33					
34					
35					
36					
<b>TOTAL COST:</b>					<b>\$46,769</b>

**URS CORPORATION**  
**CONSTRUCTION COST ESTIMATE**  
**ESTIMATED UNIT COST**

Client: NYSDEC	Project Number: 11174770	Date: 29-Sep-06
Project: Kliegman Brothers Site - OU2	Calculated By: P. Baker	
Title: Alternative 2B - Ground Water Recovery Well Installation	Checked By: J. Sundquist	Date: 2-Jul-07

ITEM	DESCRIPTION	QTY.	UNITS	UNIT COST	TOTAL COST
1	Sawcut pavement	2650	lf	\$2.02	\$5,353
2	Excavation - trench and vault	1325	lf	\$9.60	\$12,720
3	Extraction well installation	160	vlf	\$186.00	\$29,760
4	Precast concrete vault with road cover - 6' x 6' x 6'	2	ea	\$5.00	\$10
5	Pipe bedding	2,650	lf	\$1.79	\$4,744
6	Discharge line - 4" HDPE pipe	1,325	lf	\$9.50	\$12,588
7	Pump - 10 HP, 150 gpm , 80' head	2	ea	\$4,800.00	\$9,600
8	Electrical conduit - 2" PVC	1325	lf	\$20.00	\$26,500
9	Pump - electric and controls - Allowance:	1	ls	\$13,000.00	\$13,000
10	Pump - pipe, valves, fittings - Allowance:	1	ls	\$3,000.00	\$3,000
11	Pavement restoration	300	sy	\$25.84	\$7,752
12	Traffic control - Allowance	4	wk	\$7,000.00	\$28,000
13	Drill cuttings disposal	12	drum	\$300.00	\$3,600
14				<b>SUBTOTAL</b>	<b>\$156,626</b>
15	<b>LOCATION COST ADJUSTMENT FACTOR - QUEENS, NY</b>			<b>1.269</b>	<b>\$198,758</b>
16					
17					
18					
19					
20					
21					
22					
23					
24					
25					
26					
27					
28					
29					
<b>TOTAL COST:</b>					<b>\$198,758</b>



**URS CORPORATION**  
**CONSTRUCTION COST ESTIMATE**  
**ESTIMATED UNIT COST**

Client: NYSDEC	Project Number: 11174770	
Project: Kliegman Brothers Site - OU2	Calculated By: P. Baker	Date: 29-Sep-06
Title: Alternative 2B - Ground Water Treatment System	Checked By: J. Sundquist	Date: 2-Jul-07

ITEM	DESCRIPTION	QTY.	UNITS	UNIT COST	TOTAL COST
1	Air stripper - horiz.tray , 300 GPM w / blower and controls	1	ea	\$54,000.00	\$54,000
2	Vapor Phase Carbon Adsorber	1	ea	\$15,483.00	\$15,483
	Activated carbon including initial charge and yr 1 regeneration	37,500	lb	\$2.60	\$97,500
3	System controls	1	ea	\$20,000.00	\$20,000
4	Electrical power drop - 230V - 3 phase within 50'	1	ls	\$20,000.00	\$20,000
5	Electrical installation	1	ls	\$15,000.00	\$15,000
6	Sanitary sewer discharge connection (within 50')	1	ls	\$15,000.00	\$15,000
7	Installation, including pipe, valves, fittings - Allowance:	1	ls	\$14,000.00	\$14,000
8	System startup	1	ls	\$20,000.00	\$20,000
9	Concrete pad - 25' x 10' x 1'	10	cy	\$350.00	\$3,500
10				<b>SUBTOTAL</b>	<b>\$274,483</b>
11					
12					
13	<b>LOCATION COST ADJUSTMENT FACTOR - QUEENS, NY</b>			<b>1.269</b>	<b>\$348,319</b>
14					
15					
16					
17					
18					
19					
20					
21					
22					
23					
24					
25					
26					
27					
28					
29					
30					
<b>TOTAL COST:</b>					<b>\$348,319</b>

**URS CORPORATION**  
**ENGINEER'S COST ESTIMATE**  
**ESTIMATED UNIT COST**

Client: NYSDEC	Project Number: 11174770	Date: 2-Jul-07
Project: Kliegman Bros. Site	Calculated By: PB	
Title: Alternative 2B - Annual Operation and Maintenance - 30 Year Period	Checked By: J. Sundquist	Date: 10-Oct-07

ITEM	DESCRIPTION	QTY.	UNITS	UNIT COST	TOTAL COST
1	Monitoring Well Sampling - Labor: 4 wells / day @ 20 mhr	180	man hour	\$60.00	\$10,800
2	Sample Analysis: Annual	36	each	\$150.00	\$5,400
3	Reports	1	ls	\$2,500.00	\$2,500
4	Air Monitoring - Labor 2 days/event * 2 events/yr	40	man hour	\$60.00	\$2,400
5	Sub-slab depressurizations installation	3	year	\$3,500.00	\$10,500
6	Repair Security Fence - Allowance	1	ls	\$250.00	\$250
7	Groundwater treatment plant operation - Allow:	12	month	\$5,500.00	\$66,000
8	Pumping system repairs / maintenance - Allow	1	ls	\$5,000.00	\$5,000
9	Utilities - Electricity: Allowance	1	year	\$17,682.00	\$17,682
10	Activated carbon including changeout and regeneration	3,900	lb/yr	\$2.05	\$7,991
11	Sanitary sewer discharge	12	month	\$3,000.00	\$36,000
10				<b>SUBTOTAL</b>	<b>\$164,523</b>
11	<b>LOCATION COST ADJUSTMENT FACTOR - QUEENS, NY on</b>		<b>\$164,523</b>	<b>1.269</b>	<b>\$208,779</b>
12					
13					
14					
15					
16					
17					
18					
19					
20					
21					
22					
23					
24					
25					
26					
27					
28				<b>Subtotal</b>	<b>\$208,779</b>
29				<b>Contractors Overhead and Profit 25%</b>	<b>\$52,195</b>
30				<b>Subtotal</b>	<b>\$260,974</b>
31				<b>Contingency 30%</b>	<b>\$78,292</b>
32				<b>Subtotal</b>	<b>\$339,266</b>
33				<b>Present Worth (30 yr. @ 5% discount)</b>	<b>15.373</b>
34					
	<b>TOTAL COST:</b>				<b>\$5,215,537</b>

**NYSDEC  
KLIEGMAN BROTHERS SITE  
FEASIBILITY STUDY  
ENGINEER'S COST ESTIMATE**

Client: NYSDEC	Project Number: 11174770	
Project: Kliegman Brothers Site - OU2	Calculated By: P. Baker/BBV	Date: 7/2/07&9/07
Description: Alternative 3A - In Situ Chemical Oxidation of Concentrated Plume Area	Checked By: J. Sundquist	Date: 7/2/07&9/07

**SUMMARY**

DESCRIPTION	ESTIMATED COST
<b>Mobilization and Demobilization</b>	<b>\$38,284</b>
<b>Well Installation and Chemical Treatment</b>	<b>\$4,533,900</b>
<b>SUBTOTAL</b>	<b>\$4,572,184</b>

**STANDARD SUPPLEMENTAL PROJECT COSTS**

<b>Overhead and Profit 25.00%</b>	<b>\$1,143,046</b>
<b>SUBTOTAL</b>	<b>\$5,715,230</b>
<b>Contingency 30.00%</b>	<b>\$1,714,569</b>
<b>SUBTOTAL CONSTRUCTION COSTS</b>	<b>\$7,429,799</b>
<b>Engineering Design 3.5%</b>	<b>\$260,043</b>
<b>TOTAL CAPITAL COST</b>	<b>\$7,689,842</b>
<b>Annual Operation and Maintenance Cost</b>	<b>\$282,200</b>
<b>ALTERNATIVE 3A - TOTAL COST</b>	<b>\$7,972,042</b>
<b>BUDGETARY TOTAL COST</b>	<b>\$7,973,000</b>

**URS CORPORATION**  
**CONSTRUCTION COST ESTIMATE**  
**ESTIMATED UNIT COST**

Client: NYSDEC	Project Number: 11174770	
Project: Kliegman Brothers Site - OU2	Calculated By: P. Baker	Date: 29-Sep-06
Title: Alternative 3A Mobilization/Demobilization	Checked By: J. Sundquist	Date: 1-Nov-06

ITEM	DESCRIPTION	QTY.	UNITS	UNIT COST	TOTAL COST
1	Submittals				
2	Health and Safety Plan	1	ls	\$2,500	\$2,500
3	Shop drawings	1	ls	\$2,500	\$2,500
4	Schedules	1	ls	\$3,000	\$3,000
5	Record drawings	1	ls	\$2,500	\$2,500
6	Survey	2	day	\$1,186	\$2,372
7	Permits and easements - Allowance	1	ls	\$20,000	\$20,000
8	Portable toilet	2	mo	\$206	\$412
9	Drill rig move/demove	1	ls	\$5,000	\$5,000
10					
11					
12					
13					
14					
15					
16					
17					
18					
19					
20					
21					
22					
23					
24					
25					
26					
27					
28					
29					
30					
31					
32					
33					
34					
35					
<b>TOTAL COST:</b>					<b>\$38,284</b>



**URS CORPORATION**  
**ENGINEER'S COST ESTIMATE**  
**ESTIMATED UNIT COST**

Client: NYSDEC	Project Number: 11174770	Date: 2-Jul-07
Project: Kliegman Bros. Site	Calculated By: PB	
Title: Alternative 3A - Annual Operation and Maintenance - 5 Year Period	Checked By: J. Sundquist	Date: 2-Jul-07

ITEM	DESCRIPTION	QTY.	UNITS	UNIT COST	TOTAL COST
1	Monitoring Well Sampling - Labor: 4 wells / day @ 20 mhr	180	man hour	\$60	\$10,800
2	Sample Analysis: Annually for 5 years	36	each	\$150	\$5,400
3	Air Monitoring - Labor 2 days/event * 2 events/yr	40	man hour	\$60	\$2,400
4	Sub-slab depressurization installation	3	ls	\$3,500	\$10,500
5	Reports	1	each	\$2,500	\$2,500
4				<b>SUBTOTAL</b>	<b>\$31,600</b>
5	<b>LOCATION COST ADJUSTMENT FACTOR - QUEENS, NY</b>			<b>1.269</b>	<b>\$40,100</b>
6					
7					
8					
9					
10					
11					
12					
13					
14					
15					
16					
17					
18					
19					
20					
21					
22				<b>Subtotal</b>	<b>\$40,100</b>
23	<b>Contractors Overhead and Profit</b>			<b>25%</b>	<b>\$10,025</b>
24				<b>Subtotal</b>	<b>\$50,126</b>
25	<b>Contingency</b>			<b>30%</b>	<b>\$15,038</b>
26				<b>Subtotal</b>	<b>\$65,163</b>
27	<b>Present Worth (5 yr. @ 5% discount)</b>			<b>4.330</b>	<b>\$282,156</b>
28					
<b>TOTAL COST:</b>					<b>\$282,200</b>

**NYSDEC  
KLIEGMAN BROTHERS SITE  
FEASIBILITY STUDY  
ENGINEER'S COST ESTIMATE**

Client: NYSDEC	Project Number: 11174770	
Project: Kliegman Brothers Site - OU2	Calculated By: P. Baker	Date: 2-Jul-07
Description: Alternative 3B - In Situ Chemical Oxidation of Expanded Plume Area	Checked By: J. Sundquist	Date: 30-Jan-08

**SUMMARY**

DESCRIPTION	ESTIMATED COST
<b>Mobilization and Demobilization</b>	<b>\$58,696</b>
<b>Well Installation and Chemical Treatment</b>	<b>\$8,181,558</b>
<b>SUBTOTAL</b>	<b>\$8,240,254</b>

**STANDARD SUPPLEMENTAL PROJECT COSTS**

<b>Overhead and Profit 25.00%</b>	<b>\$2,060,063</b>
<b>SUBTOTAL</b>	<b>\$10,300,317</b>
<b>Contingency 30.00%</b>	<b>\$3,090,095</b>
<b>SUBTOTAL CONSTRUCTION COSTS</b>	<b>\$13,390,412</b>
<b>Engineering Design 2%</b>	<b>\$267,808</b>
<b>TOTAL CAPITAL COST</b>	<b>\$13,658,221</b>
<b>Annual Operation and Maintenance Cost</b>	<b>\$282,200</b>
<b>ALTERNATIVE 3B - TOTAL COST</b>	<b>\$13,940,421</b>
<b>TOTAL BUDGETARY COST</b>	<b>\$13,941,000</b>

**URS CORPORATION**  
**CONSTRUCTION COST ESTIMATE**  
**ESTIMATED UNIT COST**

Client: NYSDEC	Project Number: 11174770	
Project: Kliegman Brothers Site - OU2	Calculated By: P. Baker	Date: 26-Sep-07
Title: Alternative 3B Mobilization/Demobilization	Checked By: J. Sundquist	Date: 1-Nov-06

ITEM	DESCRIPTION	QTY.	UNITS	UNIT COST	TOTAL COST
1	Submittals				
2	Health and Safety Plan	1	ls	\$2,500	\$2,500
3	Shop drawings	1	ls	\$2,500	\$2,500
4	Schedules	1	ls	\$3,000	\$3,000
5	Record drawings	1	ls	\$2,500	\$2,500
6	Survey	2	day	\$1,186	\$2,372
7	Permits and easements - Allowance	1	ls	\$40,000	\$40,000
8	Portable toilet	4	mo	\$206	\$824
9	Drill rig move/demove	1	ls	\$5,000	\$5,000
10					
11					
12					
13					
14					
15					
16					
17					
18					
19					
20					
21					
22					
23					
24					
25					
26					
27					
28					
29					
30					
<b>TOTAL COST:</b>					<b>\$58,696</b>





**URS CORPORATION**  
**ENGINEER'S COST ESTIMATE**  
**ESTIMATED UNIT COST**

Client: NYSDEC	Project Number: 11174770	Date: 29-Sep-06
Project: Kliegman Bros. Site	Calculated By: PB	
Title: Alternative 3B - Annual Sampling, Analysis and Reporting - 5 Year Period	Checked By: J. Sundquist	Date: 2-Jul-07

ITEM	DESCRIPTION	QTY.	UNITS	UNIT COST	TOTAL COST
1	Monitoring Well Sampling - Labor: 4 wells / day @ 20 mhr	180	man hour	\$60	\$10,800
2	Sample Analysis: Annually for 5 years	36	each	\$150	\$5,400
3	Air Monitoring - Labor 2 days/event * 2 events/yr	40	man hour	\$60	\$2,400
4	Sub-slab depressurization installation	3	yr	\$3,500	\$10,500
5	Reports	1	each	\$2,500	\$2,500
4				<b>SUBTOTAL</b>	<b>\$31,600</b>
5	<b>LOCATION COST ADJUSTMENT FACTOR - QUEENS, NY</b>			<b>1.269</b>	<b>\$40,100</b>
6					
7					
8					
9					
10					
11					
12					
13					
14					
15					
16					
17					
18					
19					
20					
21					
22				<b>Subtotal</b>	<b>\$40,100</b>
23				<b>Contractors Overhead and Profit</b>	<b>25%</b>
24				<b>Subtotal</b>	<b>\$50,126</b>
25				<b>Contingency</b>	<b>30%</b>
26				<b>Subtotal</b>	<b>\$65,163</b>
27				<b>Present Worth (5 yr. @ 5% discount)</b>	<b>4.330</b>
28					
<b>TOTAL COST:</b>					<b>\$282,200</b>

**NYSDEC  
KLIEGMAN BROTHERS SITE  
FEASIBILITY STUDY  
ENGINEER'S COST ESTIMATE**

Client:	NYSDEC	Project Number:	11174770
Project:	Kliegman Brothers Site - OU2	Calculated By:	P. Baker
	Alternative 4 - In Situ Chemical Treatment of		Date: 2-Jul-07
Description:	Concentrated Plume Area with Induced	Checked By:	J. Sundquist
	Groundwater Gradient		Date: 13-Sep-07

**SUMMARY**

DESCRIPTION	ESTIMATED COST
<b>Mobilization and Demobilization</b>	<b>\$36,769</b>
<b>Extraction Well Installation</b>	<b>\$64,182</b>
<b>Ground Water Treatment System</b>	<b>\$964,500</b>
<b>In Situ Chemical Treatment</b>	<b>\$3,237,737</b>
<b>SUBTOTAL</b>	<b>\$4,303,188</b>

**STANDARD SUPPLEMENTAL PROJECT COSTS**

<b>Overhead and Profit 25.00%</b>	<b>\$1,075,797</b>
<b>SUBTOTAL</b>	<b>\$5,378,985</b>
<b>Contingency 30.00%</b>	<b>\$1,613,695</b>
<b>SUBTOTAL CONSTRUCTION COSTS</b>	<b>\$6,992,680</b>
<b>Engineering Design 4%</b>	<b>\$279,707</b>
<b>TOTAL CAPITAL COST</b>	<b>\$7,272,388</b>
<b>Annual Operation and Maintenance Cost</b>	<b>\$284,400</b>
<b>ALTERNATIVE 4 - TOTAL COST</b>	<b>\$7,556,788</b>
<b>ALTERNATIVE 4 - BUDGETARY COST</b>	<b>\$7,557,000</b>

**URS CORPORATION**  
**CONSTRUCTION COST ESTIMATE**  
**ESTIMATED UNIT COST**

Client: NYSDEC	Project Number: 11174770	Date: 29-Oct-06
Project: Kliegman Brothers Site - OU2	Calculated By: P. Baker	
Title: Alternative 4 - Mobilization/Demobilization	Checked By: J. Sundquist	Date: 1-Nov-06

ITEM	DESCRIPTION	QTY.	UNITS	UNIT COST	TOTAL COST
1	Submittals				
2	Health and Safety Plan	1	ls	\$2,500	\$2,500
3	Shop drawings	1	ls	\$2,500	\$2,500
4	Schedules	1	ls	\$3,000	\$3,000
5	Record drawings	1	ls	\$2,500	\$2,500
6	Survey	2	day	\$1,186	\$2,372
7	Security fence	250	lf	\$54	\$13,485
8	Permits and easements - Allowance	1	ls	\$10,000	\$10,000
9	Portable toilet	2	mo	\$206	\$412
10					
11					
12					
13					
14					
15					
16					
17					
18					
19					
20					
21					
22					
23					
24					
25					
26					
27					
28					
29					
30					
<b>TOTAL COST:</b>					<b>\$36,769</b>

**URS CORPORATION**  
**CONSTRUCTION COST ESTIMATE**  
**ESTIMATED UNIT COST**

Client: NYSDEC	Project Number: 11174770	Date: 29-Oct-06
Project: Kliegman Brothers Site - OU2	Calculated By: P. Baker	Date: 1-Nov-06
Title: Alternative 4 - Ground Water Recovery Well Installation	Checked By: J. Sundquist	

ITEM	DESCRIPTION	QTY.	UNITS	UNIT COST	TOTAL COST
1	Sawcut pavement	1100	lf	\$2.02	\$2,222
2	Excavation - trench and vault	1100	lf	\$9.60	\$10,560
3	Extraction well installation	80	vlf	\$186.50	\$14,920
4	Precast concrete vault with road cover - 6' x 6' x 6'	1	ea	\$4,875	\$4,875
5	Pipe bedding	2,200	lf	\$1.79	\$3,938
5	Discharge line - 4" HDPE pipe	550	lf	\$9.50	\$5,225
6	Pump - 10 HP, 150 gpm , 80' head	1	ea	\$4,800	\$4,800
7	Electrical conduit - 2" PVC	550	lf	\$20	\$11,000
8	Pump - electric and controls - Allowance:	1	ls	\$6,500	\$6,500
9	Pump - pipe, valves, fittings - Allowance:	1	ls	\$1,500	\$1,500
10	Pavement restoration	300	sy	\$25.84	\$7,752
11	Traffic control - Allowance	4	wk	\$3,000	\$12,000
12	Dispose of drill cuttings	6	drums	\$300	\$1,800
13				<b>SUBTOTAL</b>	<b>\$50,577</b>
14	<b>LOCATION COST ADJUSTMENT FACTOR - QUEENS, NY</b>			<b>1.269</b>	<b>\$64,182</b>
15					
16					
17					
18					
19					
20					
21					
22					
23					
24					
25					
26					
27					
28					
29					
30					
<b>TOTAL COST:</b>					<b>\$64,182</b>

**URS CORPORATION**  
**CONSTRUCTION COST ESTIMATE**  
**ESTIMATED UNIT COST**

Client: NYSDEC	Project Number: 11174770	
Project: Kliegman Brothers Site - OU2	Calculated By: P. Baker	Date: 13-Sep-07
Title: Alternative 4 - Ground Water Treatment System	Checked By: J. Sundquist	Date: 13-Sep-07

ITEM	DESCRIPTION	QTY.	UNITS	UNIT COST	TOTAL COST
1	Air stripper - horiz.tray , 150 GPM w / blower and controls	1	ea	\$45,000	\$45,000
2	Vapor phase carbon adsorber unit	1	ea	\$15,483	\$15,483
3	Activated carbon including initial charge and yr 1 regeneration	76,500	lb	\$2.60	\$198,900
4	System controls	1	ea	\$20,000	\$20,000
5	Electrical power drop - 230V - 3 phase within 50'	1	ls	\$20,000	\$20,000
6	Electrical installation	1	ls	\$15,000	\$15,000
7					
8	Sanitary sewer discharge connection (within 50')	1	ls	\$15,000	\$15,000
9	Installation, including pipe, valves, fittings - Allowance:	1	ls	\$14,000	\$14,000
10	System startup	1	ls	\$20,000	\$20,000
11	Security fence	250	lf	\$53.94	\$13,485
12	Concrete pad - 25' x 10' x 1'	10	cy	\$350	\$3,500
13				<b>SUBTOTAL</b>	<b>\$380,368</b>
14					
15					
16	<b>Groundwater Treatment Plant Operation - 3 yrs</b>				
17	Groundwater treatment plant operation - Allow:	36	month	\$5,500.00	\$198,000
18	Pumping system repairs / maintenance - Allow	1	ls	\$15,000.00	\$15,000
19	Utilities Electricity Allowance	3	year	\$8,841.00	\$26,523
20	Activated carbon including changeout and regeneration	42,000	lb	\$2.05	\$86,100
21	Sanitary sewer discharge	36	month	\$1,500	\$54,000
22				<b>SUBTOTAL</b>	<b>\$379,623</b>
23					
24				<b>SUBTOTAL</b>	<b>\$759,991</b>
25	LOCATION COST ADJUSTMENT FACTOR - QUEENS, NY			<b>1.269</b>	<b>\$964,429</b>
26					
27					
28					
29					
30					
31					
32					
<b>TOTAL COST:</b>					<b>\$964,500</b>

**URS CORPORATION**  
**CONSTRUCTION COST ESTIMATE**  
**ESTIMATED UNIT COST**

Client: NYSDEC	Project Number: 11174770	Date: 29-Oct-06
Project: Kliegman Brothers Site - OU2	Calculated By: P. Baker	Date: 29-Oct-06
Title: Alternative 4 - Injection Wells with In Situ Chemical Treatment	Checked By: J. Sundquist	Date: 13-Sep-07

ITEM	DESCRIPTION	QTY.	UNITS	UNIT COST	TOTAL COST
1	Core concrete sidewalk	60	ea	\$150	\$9,000
2	Injection well installation	64	ea	\$3,500	\$224,000
3	Well head modifications	64	ea	\$422	\$27,008
4	Chemical reagent injection	1	ls	\$2,264,000	\$2,264,000
5	Traffic control - Allowance	4	week	\$2,500	\$10,000
6	Drill cuttings disposal	58	drum	\$300	\$17,400
7				<b>Subtotal</b>	<b>\$2,551,408</b>
8	<b>Location Cost Adjustment Factor - Queens, NY</b>			<b>1.269</b>	<b>\$3,237,737</b>
9					
10					
11					
12					
13					
14					
15					
16					
17					
18					
19					
20					
21					
22					
23					
24					
25					
26					
27					
28					
29					
30					
<b>TOTAL COST:</b>					<b>\$3,237,737</b>

**URS CORPORATION**  
**ENGINEER'S COST ESTIMATE**  
**ESTIMATED UNIT COST**

Client: NYSDEC	Project Number: 11174770	Date: 2-Jul-07
Project: Kliegman Bros. Site	Calculated By: PB	Date: 2-Jul-07
Title: Alternative 4 - Annual Operation and Maintenance - 5 Year Period	Checked By: J. Sundquist	Date: 2-Jul-07

ITEM	DESCRIPTION	QTY.	UNITS	UNIT COST	TOTAL COST
1	Monitoring Well Sampling - Labor: 4 wells / day @ 20 mhr	180	man hour	\$60	\$10,800
2	Sample Analysis: Annual	36	each	\$150	\$5,400
3	Air Monitoring - Labor 2 days/event * 2 events/yr	40	man hour	\$60	\$2,400
4	Sub-slab depressurization system installations	3	yr	\$3,500	\$10,500
5	Reports	1	ls	\$2,500	\$2,500
6	Repair Security Fence - Allowance	1	ls	\$250	\$250
7					
8					
9					
10					
11					
10					
11					
12				<b>SUBTOTAL</b>	<b>\$31,850</b>
13	<b>Location Factor Adjustment - Queens, NY</b>			<b>1.269</b>	<b>\$40,418</b>
14					
15					
16					
17					
18					
19					
20					
21					
22					
23					
24					
25					
26					
27					
28					
29					
30				<b>Subtotal</b>	<b>\$40,418</b>
31				<b>Contractors Overhead and Profit 25%</b>	<b>\$10,104</b>
32				<b>Subtotal</b>	<b>\$50,522</b>
33				<b>Contingency 30%</b>	<b>\$15,157</b>
34				<b>Subtotal</b>	<b>\$65,679</b>
35				<b>Present Worth (5yr. @ 5% discount)</b>	<b>4.330</b>
					<b>\$284,389</b>
<b>TOTAL COST:</b>					<b>\$284,400</b>



**APPENDIX C**  
**NEW YORK CITY DEPARTMENT OF ENVIRONMENTAL**  
**PROTECTION**  
**DISCHARGE LIMITATIONS**

NEW YORK CITY DEPARTMENT OF ENVIRONMENTAL PROTECTION  
BUREAU OF WASTEWATER TREATMENT

LIMITATIONS FOR EFFLUENT TO *STORM* SEWERS

Parameter	Daily Limit	Units	Sample Type	Monthly Limit
Oil & Grease	15	mg/l	Instantaneous	
pH (range)	6.5-8.5	SU's	Instantaneous	
Benzene	134	ppb	Instantaneous	57
Ethylbenzene	380	ppb	Instantaneous	142
Toluene	74	ppb	Instantaneous	28
Xylenes ( Total )	74	ppb	Instantaneous	28
Temperature	<150	degrees F	Instantaneous	
Cadmium	2 0.69	mg/l mg/l	Instantaneous Composite	
Chromium (VI)	5	mg/l	Instantaneous	
Copper	5	mg/l	Instantaneous	
Lead	2	mg/l	Instantaneous	
Mercury	0.05	mg/l	Instantaneous	
Nickel	3	mg/l	Instantaneous	
Zinc	5	mg/l	Instantaneous	
Flash Point	>140	degrees F	Instantaneous	
Total Suspended Solids	No Limit		Instantaneous	
PCB's ( Total )*	1	ppb	Composite	
Perc (Tetrachloroethylene)	20	ppb	Instantaneous	
MTBE (Methyl-Tert-Butyl-Ether)	10	ppb	Instantaneous	10
Naphthalene	47	ppb	Composite	19
Other				

\* Analysis for PCB's are requested *only* if *both* conditions listed below are met:

- 1) if proposed discharge > 10,000 gpd;
- 2) if duration of a discharge > 10 days.

*Analysis for PCB's must be done by method 608 by EPA only with MDL=65 ppt*

NEW YORK CITY DEPARTMENT OF ENVIRONMENTAL PROTECTION  
BUREAU OF WASTEWATER TREATMENT

LIMITATIONS FOR EFFLUENT TO SANITARY OR COMBINED SEWERS

Parameter	Daily Limit	Units	Sample Type	Monthly Limit
Total Petroleum Hydrocarbons	50	mg/l	Instantaneous	
pH (range)	5 - 11	SU's	Instantaneous	
Benzene	134	ppb	Instantaneous	57
Ethylbenzene	380	ppb	Instantaneous	142
Toluene	74	ppb	Instantaneous	28
Xylenes ( Total )	74	ppb	Instantaneous	28
Temperature	<150	degrees F	Instantaneous	
Cadmium	2 0.69	mg/l mg/l	Instantaneous Composite	
Chromium (VI)	5	mg/l	Instantaneous	
Copper	5	mg/l	Instantaneous	
Lead	2	mg/l	Instantaneous	
Mercury	0.05	mg/l	Instantaneous	
Nickel	3	mg/l	Instantaneous	
Zinc	5	mg/l	Instantaneous	
Flash Point	>140	degrees F	Instantaneous	
Total Suspended Solids	No Limit		Instantaneous	
PCB's ( Total )*	1	ppb	Composite	
Perc (Tetrachloroethylene)	20	ppb	Instantaneous	
MTBE (Methyl Tert Butyl-Ether)	10	ppb	Instantaneous	10
Naphthalene	47	ppb	Composite	19
Other				

\* Analysis for PCB's are requested *only* if *both* conditions listed below are met:

- 1) if proposed discharge > 10,000 gpd;
- 2) if duration of a discharge > 10 days.

*Analysis for PCB's must be done by method 608 by EPA only with MDL=65 ppt*

